

Product: TRACK-TYPE TRACTOR

Model: D3B TRACK-TYPE TRACTOR 28Y

Configuration: D3B LGP TRACTOR / POWER SHIFT / 28Y00001-02073 (MACHINE) POWERED BY 3204 ENGINE

Disassembly and Assembly D3B TRACTOR & 931B TRACTOR TYPE LOADER POWER TRAIN

Media Number -SEN7918-02

Publication Date -01/11/2004

Date Updated -15/02/2017

SEN79180015

Sprocket Shaft, Gear And Cover

SMCS - 4055; 4058-011; 4058-012

Remove Sprocket Shaft, Gear And Cover, As A Unit

Tools Needed		A	B	C	D	E	F
5P316	Spanner Wrench	1					
5P6514	Adapter		1				
5P9736	Link Bracket			1			
1P510	Driver Group				1		
8B7554	Bearing Cup Puller Attachment					1	
8B7548	Puller Assembly					1	
8H684	Ratchet Box Wrench					1	
1P820	Puller Group						1
6V9061	Pump Group (or electric)						1
5F7343	Bearing Puller Attachment						1
9S9154	Step Plate						1
5F7342	Adapter						2
1B4207	Nut						2
3H4685	Plate						4
8B7549	Leg						2

Start By:

a. remove sprocket hubs

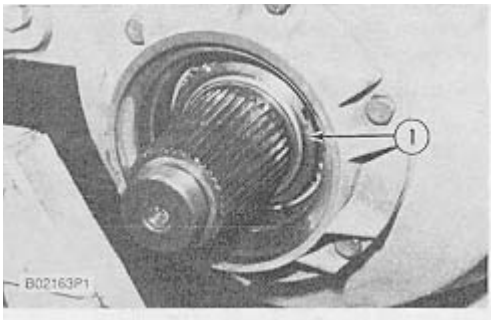

1. Drain the oil from the final drive cover.
2. Engage the brakes and remove locknut (1) with tool (A).

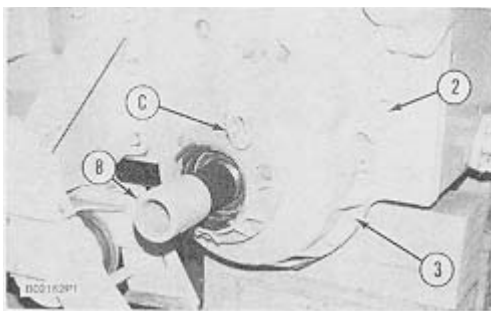

3. Install tool (B) on the end of the sprocket shaft. Install tool (C) and fasten a hoist.
4. Remove nuts (2) and bolts (3) that hold the cover to the steering clutch case.

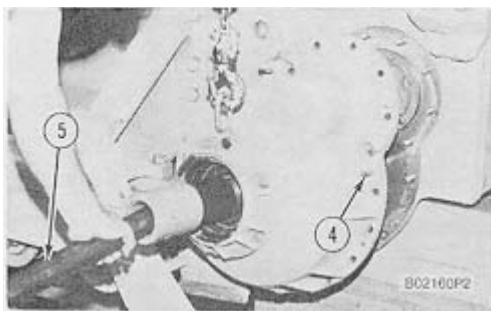

5. Install two 3/8" - 16 NC forcing screws (4). Tighten the forcing screws evenly and remove the sprocket shaft, gear and cover as a unit. Use bar (5) inside of tool (B) to keep the unit in balance when it is removed. The weight is 108 kg (240 lb).

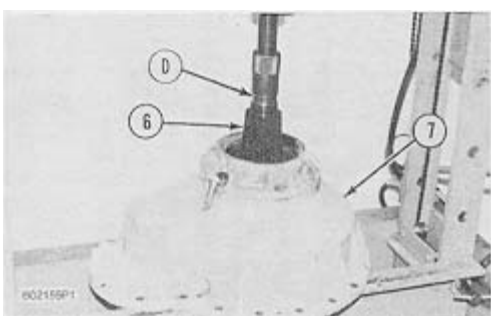

6. Remove sprocket shaft (6) and gear from cover (7) with tooling (D) and a press.

7. Remove cover (7) from the press. The weight is 56 kg (125 lb). Remove sprocket shaft (6) and gear from the press. The weight is 52 kg (115 lb).

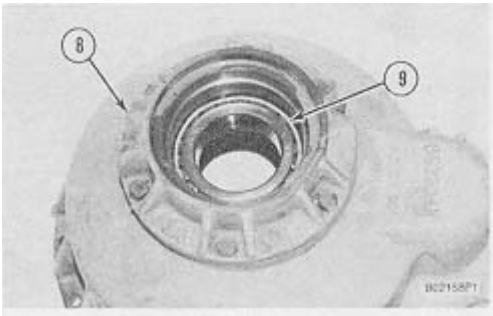

8. Remove retainer (8) and bearing cone (9) from the cover.

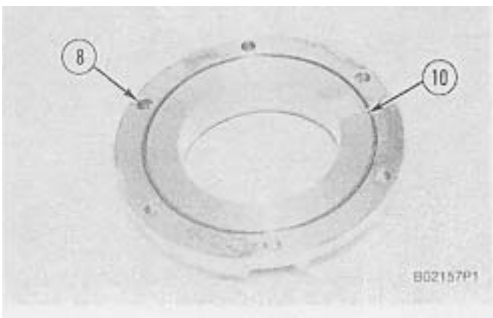

9. Remove O-ring seal (10) from retainer (8).

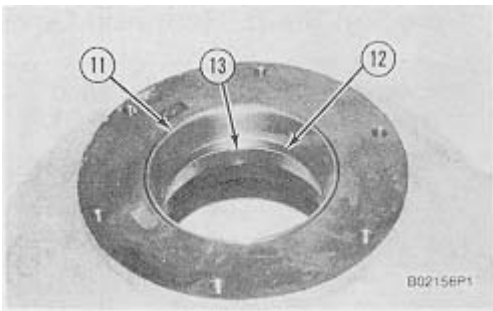

10. If a replacement is needed, remove bearing cup (11), spacer (12) and bearing cup (13) from the cover.

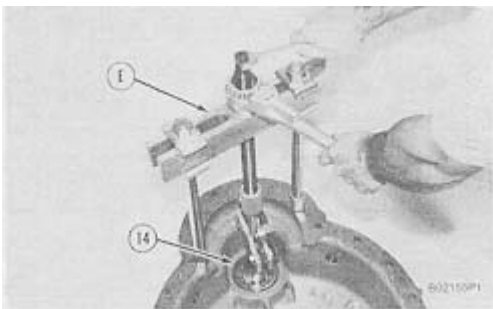

NOTE: Do not remove race and roller assembly (14) unless a replacement is needed. The bearing can be damaged when removed.

<https://www.ebooklibonline.com>

Hello dear friend!

Thank you very much for reading.

Enter the link into your browser.

The full manual is available for immediate download.

<https://www.ebooklibonline.com>

11. Remove race and roller assembly (14) from the cover with tool (E).

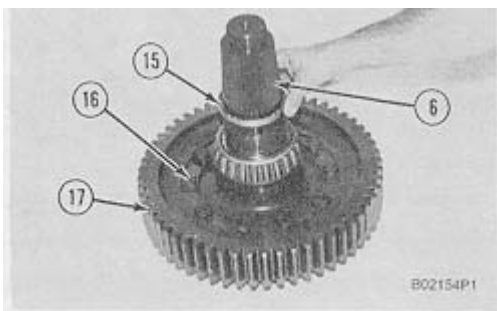

12. Remove spacer (15) from the sprocket shaft (16).

13. Remove nuts and bolts (16) that hold the sprocket shaft and gear together. Remove gear (17).

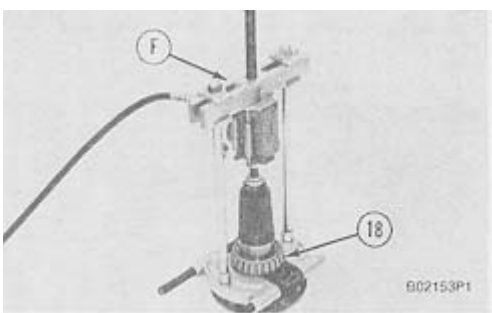

14. Remove bearing cone (18) from the sprocket shaft with tooling (F).

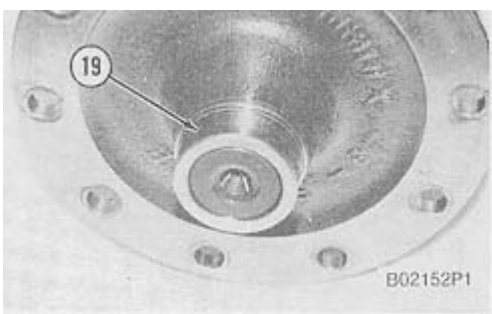

15. If a replacement is needed, remove bearing race (19) from the sprocket shaft.

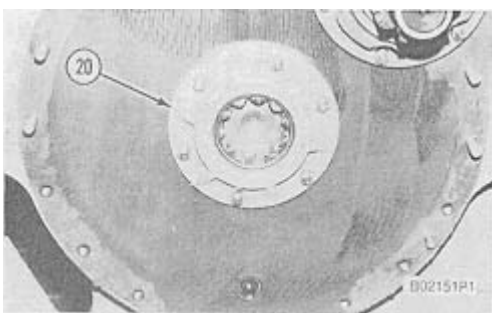

16. Remove bearing cage (20) from the steering clutch case.

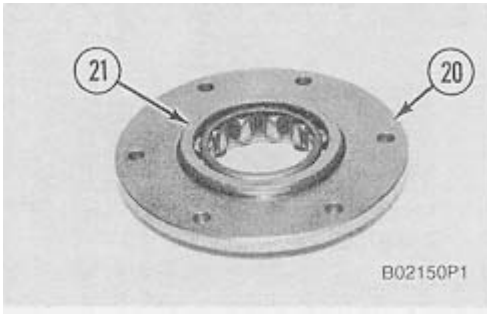

NOTE: Do not remove race and roller assembly (21) unless a replacement is needed. The bearing can be damaged when removed.

17. Remove race and roller assembly (21) from bearing cage (20).

Install Sprocket Shaft, Gear And Cover, As A Unit

Tools Needed		G	H	I	J	K	L
1P520	Driver Group	1					
1P510	Driver Group		1				
9S8900	Cylinder Group			1			
6V9061	Pump Group (or electric)			1			
5F9892	Pin			1			
5P6541	Sleeve			1			
5P6514	Adapter			1			
5F9888	Coupling			1			
5P9736	Link Bracket				1		
5P316	Spanner Wrench					1	1
9S7353	Torque Wrench					1	
8H8561	Adapter					1	
9S7352	Torque Wrench						1
5P7450	Torque Multiplier						1

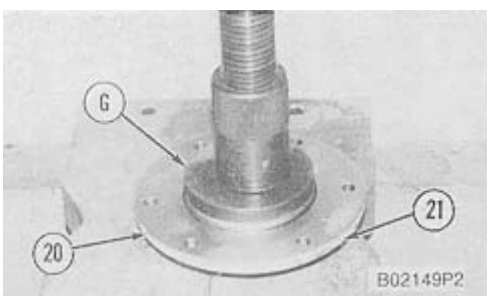

1. Install race and roller assembly (21) in bearing cage (20) with tooling (G) and a press.

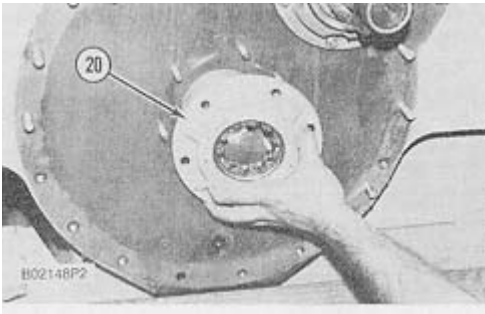

2. Install bearing cage (20) on the steering clutch case.

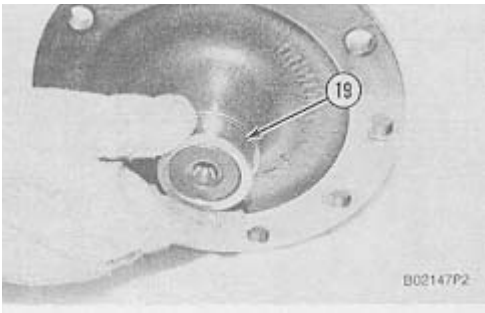

3. If bearing race (19) was removed, heat bearing race (19) to a maximum temperature of 135° C (275°F). Install bearing race (19) on the sprocket shaft. If necessary, use tooling (H) to install bearing race.

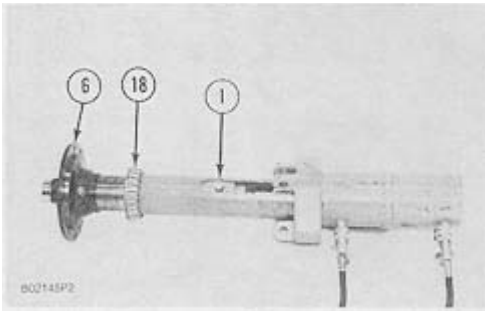

4. Install bearing cone (18) on sprocket shaft (6) with tooling (I). Use a force of 98 to 240 kN (11 to 27 ton).

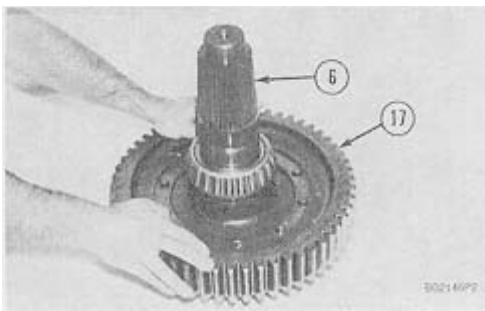

5. Install gear (17) on sprocket shaft (6). Install the bolts and nuts that hold the gear and sprocket together. Tighten the nuts to a torque of 80 ± 7 N·m (60 ± 5 lb ft). Turn the nuts an additional $120^\circ \pm 5^\circ$. Minimum torque must be 307 N·m (230 lb ft).

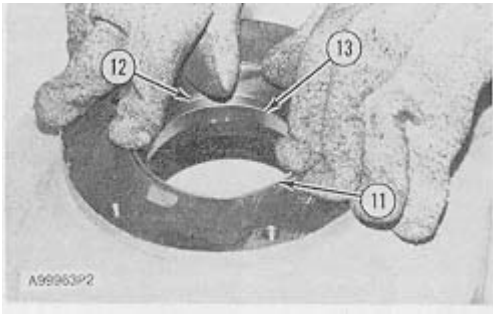

6. Lower the temperature of bearing cups (13) and (11). Install bearing cup (13) spacer (12) and bearing cup (11) in the cover.

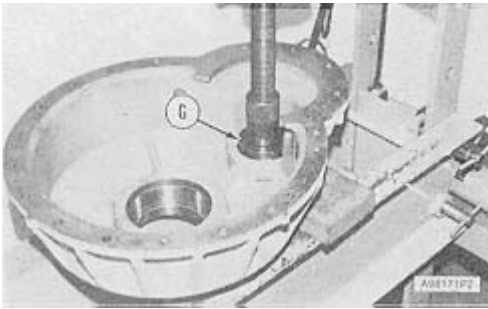

7. If the race and roller assembly wash removed, install the race and roller in the cover with tooling (G) and a press.

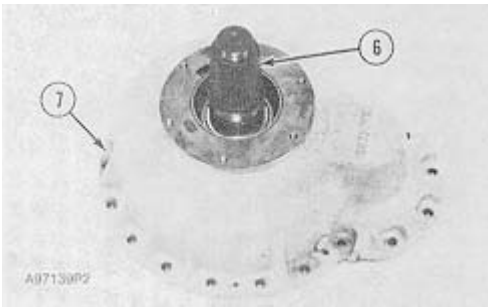

8. Put sprocket shaft (6) and gear on wooden block. Put cover (7) in position on the sprocket shaft and gear.

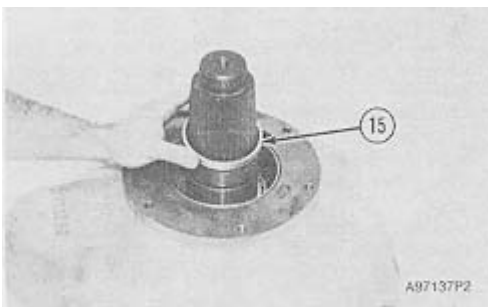

9. Install spacer (15) on the sprocket shaft.

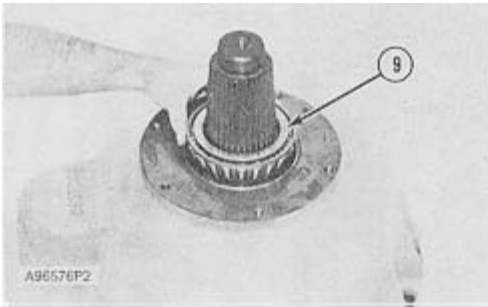

10. Put bearing cone (9) in position on the sprocket shaft.

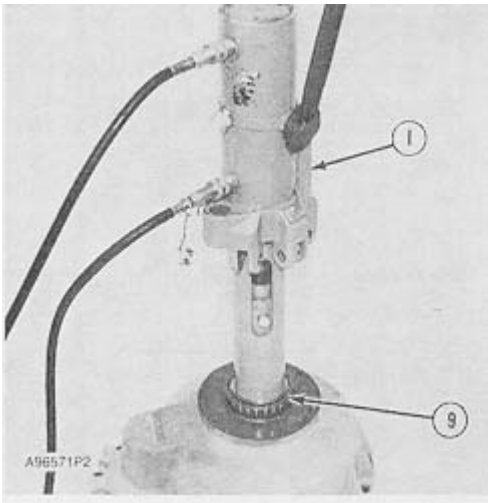

11. Use tooling (I) as shown and install bearing cone (9) on the sprocket shaft with a force of 178 to 240 kN (20 to 27 ton). Turn the cover to put the bearing cones on their seats in the bearing cups.

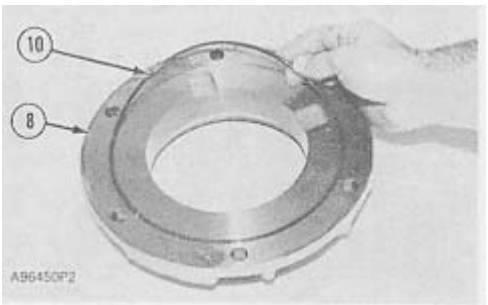

12. Inspect O-ring seal (10) for damage and make a replacement if needed. Install O-ring seal (10) on retainer (8).

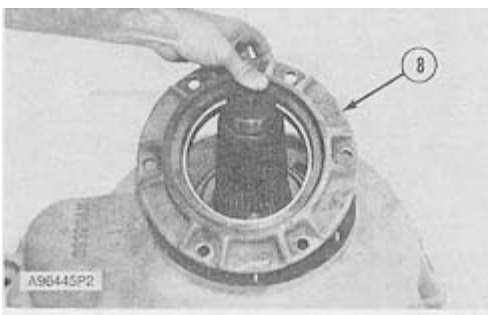

13. Put retainer (8) in position on the cover.

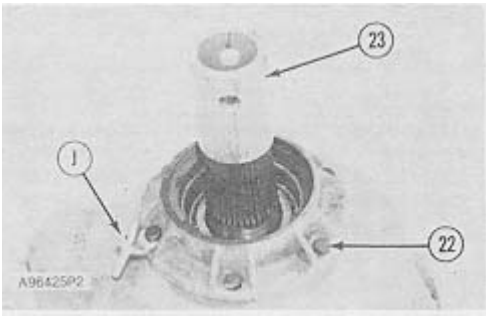

14. Install bolts (22) and tooling (J). Install 5P6514 Adapter (23) [part of tooling (I)] on the end of the sprocket shaft.

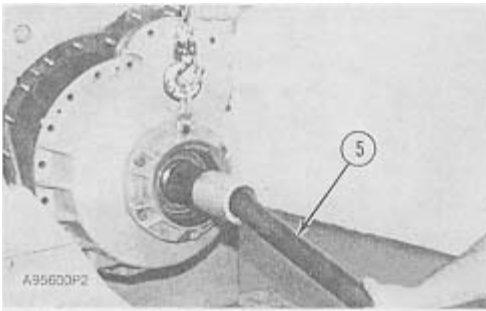

15. Fasten a hoist to tooling (J). Put 138-8436 Liquid Gasket Material on the cover and the steering clutch case that makes contact with each other. Install bar (5) in the 5P6514 Adapter to put the sprocket shaft, gear and cover in balance. Install the unit on the steering clutch case. Install the nuts and bolts that hold the cover to the steering clutch case.

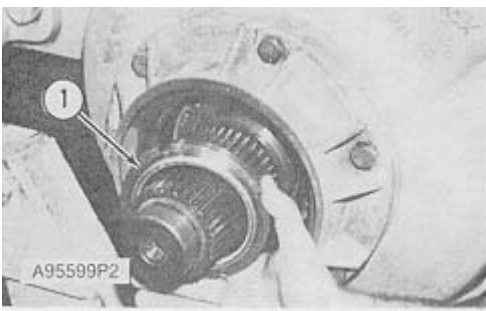

16. Put oil on threads and friction material of locknut (1). If oil is not used, the friction material will be destroyed when it is put on the threads of the sprocket shaft.

17. Install locknut (1) and turn it on the sprocket shaft until the threads of the sprocket shaft begin to show beyond the friction material of the locknut.

NOTE: The torque needed to turn the locknut is with clean threads, with oil and all friction material engaged on sprocket shaft threads, but locknut not in contact with bearing.

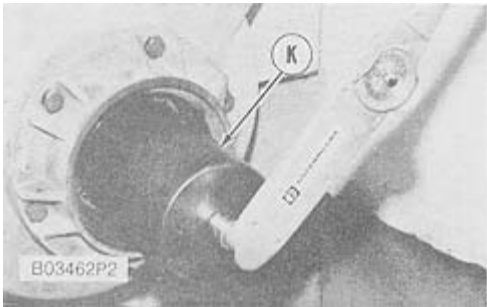

18. Use tooling (K) and check the torque needed to turn locknut (1). If the same locknut is used again, it must take at least 55 N·m (40 lb ft) to turn the locknut. If not, use a new locknut with oil on the threads and friction material of locknut. A new locknut must take at least 80 N·m (60 lb ft) to turn it.

19. Use tooling (L) and tighten locknut (1) to a torque of 810 ± 70 N·m (600 ± 50 lb ft).

20. Fill the final drive with oil after sprocket hub is installed. See the Operation And Maintenance Manual.

End By:

a. install sprocket hubs

Product: TRACK-TYPE TRACTOR

Model: D3B TRACK-TYPE TRACTOR 28Y

Configuration: D3B LGP TRACTOR / POWER SHIFT / 28Y00001-02073 (MACHINE) POWERED BY 3204 ENGINE

Disassembly and Assembly D3B TRACTOR & 931B TRACTOR TYPE LOADER POWER TRAIN

Media Number -SEN7918-02

Publication Date -01/11/2004

Date Updated -15/02/2017

SEN79180016

Drive Shaft

SMCS - 3253-010

Remove And Install Drive Shaft

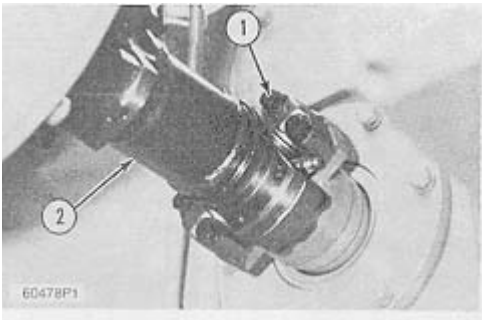

1. Remove the transmission guard with a floor jack. The weight of the transmission guard is 45 kg (100 lb).
2. Remove bolts (1) from the transmission output flange and pinion shaft.
3. Remove drive shaft (2).

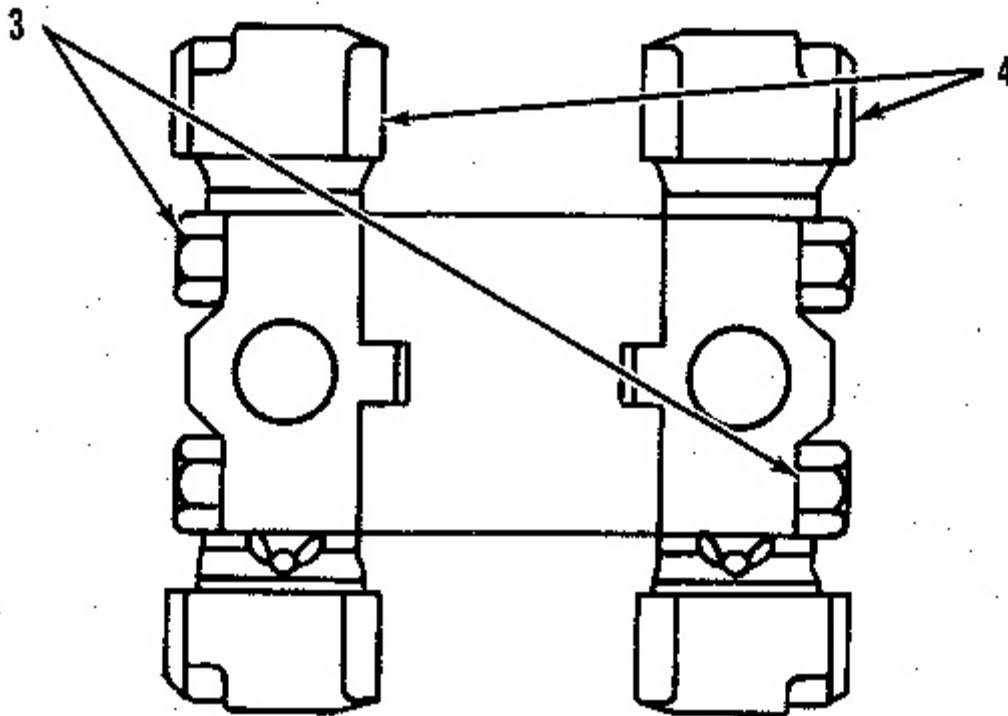

A93312P2

4. Remove bolts (3), and spider and bearing assemblies (4) from the drive shaft.

NOTE: The following steps are for installation of the drive shaft.

5. Put spider and bearing assemblies (4) in position on the drive shaft, and install bolts (3). Tighten the bolts to a torque of $35 \pm 3 \text{ N}\cdot\text{m}$ ($26 \pm 2 \text{ lb ft}$)

6. Put drive shaft (2) in position on the transmission output flange and pinion shaft, and install bolts (1). Tighten the bolts to a torque of $35 \pm 2 \text{ N}\cdot\text{m}$ ($26 \pm 1 \text{ lb ft}$)

7. Install the transmission guard.

Product: TRACK-TYPE TRACTOR

Model: D3B TRACK-TYPE TRACTOR 28Y

Configuration: D3B LGP TRACTOR / POWER SHIFT / 28Y00001-02073 (MACHINE) POWERED BY 3204 ENGINE

Disassembly and Assembly D3B TRACTOR & 931B TRACTOR TYPE LOADER POWER TRAIN

Media Number -SEN7918-02

Publication Date -01/11/2004

Date Updated -15/02/2017

SEN79180017

Steering Clutch Control Valves

SMCS - 4102-010; 4102-017

Remove And Install Steering Clutch Control Valves

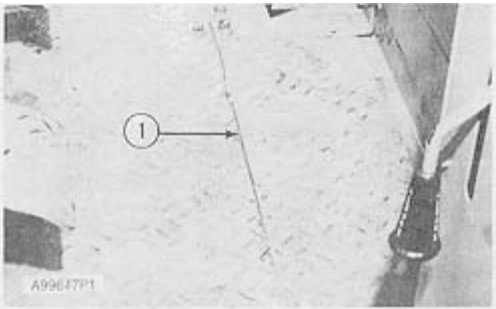

1. Remove floor plate (1) from the machine.

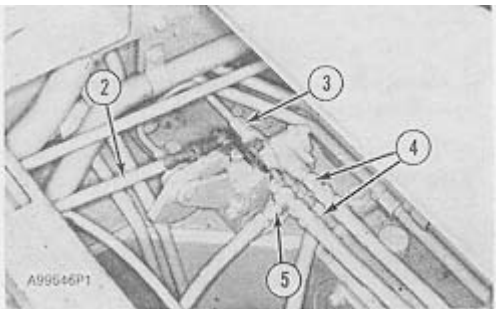

2. Disconnect oil lines (3), (4) and (5) from the steering clutch control valve.

3. Disconnect linkage rod (2) from the steering clutch control valve.

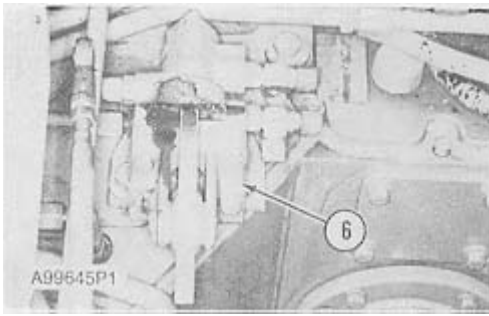

4. Remove the three bolts that hold the steering clutch control valve (6) in place. Remove the steering clutch control valve (6).

NOTE: The following steps are for installation of the steering clutch control valves.

5. Put steering clutch control valve (6) in position and install the three bolts that hold it in place.

6. Connect linkage rod (2) to the steering clutch control valve.

7. Connect oil lines (3), (4) and (5) to the steering clutch control valve.

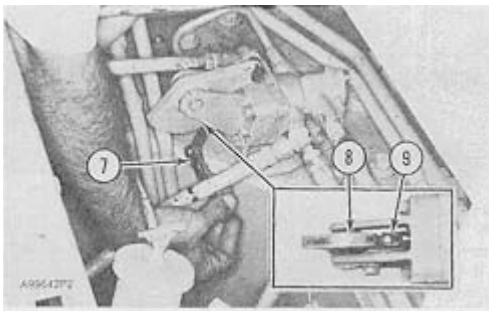

8. Use feeler gauge (7) to check the clearance between cam (8) and roller (9). With the brake pedal against the stop, the clearance must be 0.74 ± 0.74 mm ($.029 \pm 0.29$ in). Make adjustment to linkage rod (2) for correct clearance.

9. Install the floor plate on the machine.

Disassemble And Assemble Steering Clutch And Control Valves

Tools Needed		A
1P510	Driver Group	1

Start By:

a. remove steering clutch control valves

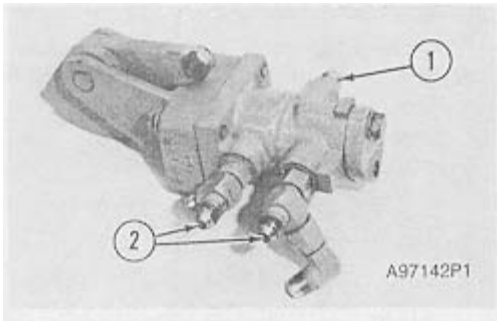

1. Put identification on fittings and covers for assembly purposes.
2. Remove fittings (1) and (2) from the valve.

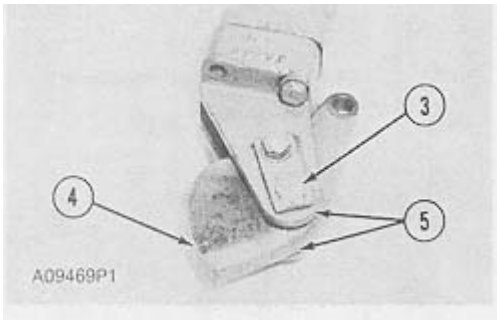

3. Remove the bolt and shaft (3). Remove cam (4) and washers (5) from the cover.

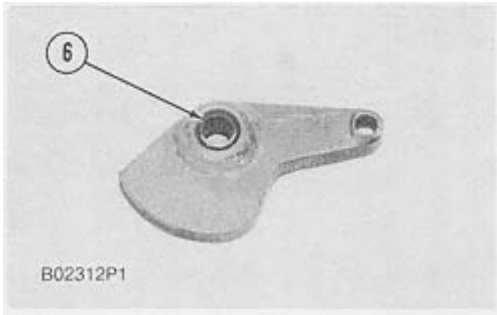

4. Remove bearing (6) from the cam.

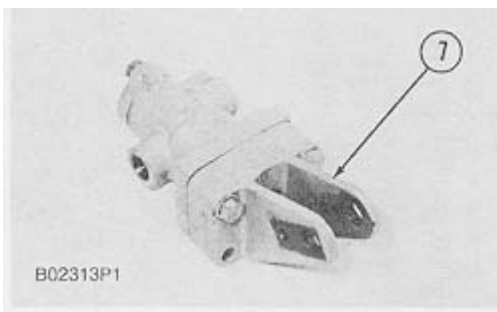

5. Remove the two bolts and cover (7) from the valve.



Suggest:

For more complete manuals. Please go to the home page.

<https://www.ebooklibonline.com>

If the above button click is invalid. Please download this document first, and then click the above link to download the complete manual.

Thank you so much for reading

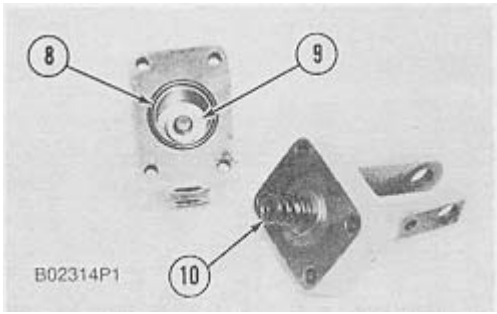

6. Remove O-ring seal (8) and spacer (9) from the valve. Remove spring (10) from the stem.

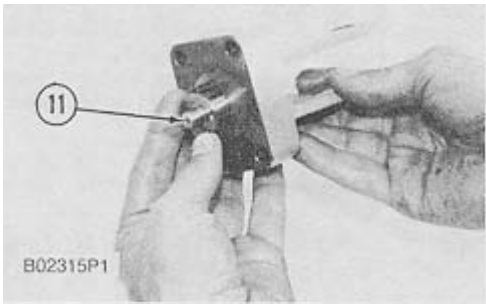

7. Pull stem (11) in until it can be turned. Turn the stem 90° and push it out until it hits the pin.

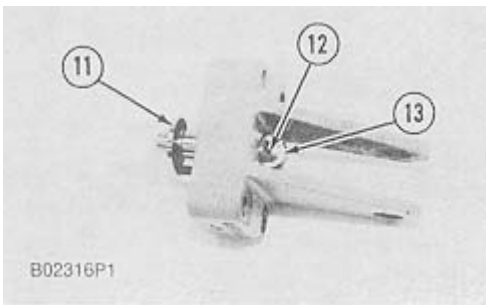

8. Remove pin (12) and roller (13) from stem (11). Remove stem (11) from the cover.

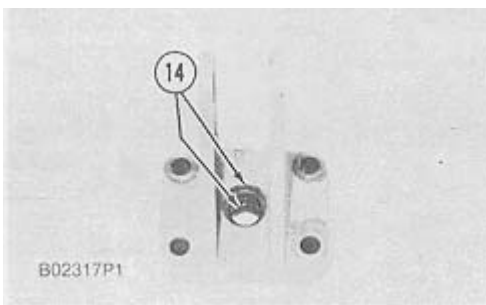

9. Remove seals (14) from the cover.

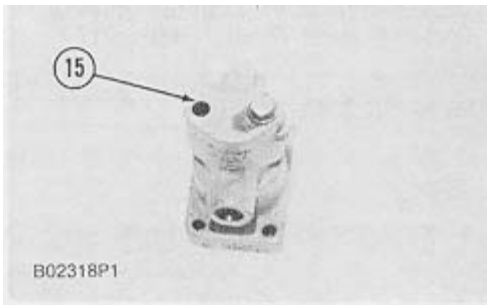

10. Remove the bolt and cover (15) from the valve.

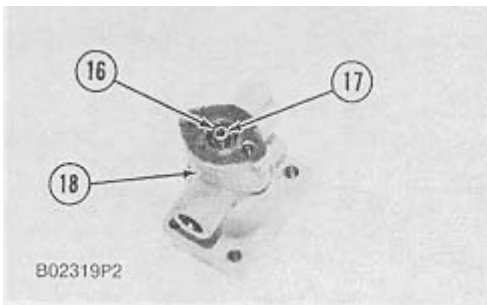

11. Remove O-ring seal (16), spring (17) and the spool from valve (18).

NOTE: The following steps are for assembly of the steering clutch control valve.

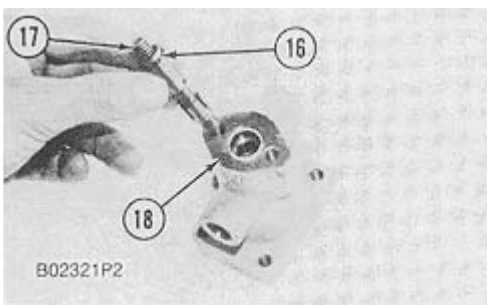

12. Put clean oil on all parts before assembly.

13. Be sure ring (16) is installed on the spool. Install small spring (17) in the end of the spool as shown. Install the spool in valve (18).

14. Install the O-ring seal on the valve.

15. Put cover (15) in position on the valve and install one bolt to hold cover in place.

16. Install seals (14) in bore in cover. Use tooling (A) to install the seal in the counterbore in the cover, with the metal case to the inside.

17. Install stem (11) in the cover. Put roller (13) in position on the stem and install pin (12) that holds it in place. Turn the stem until the notch in the stem is in alignment with the pin in the cover and push the stem out until the shoulder on the stem is against the cover.

18. Install O-ring seal (8) on the valve. Install spacer (9) on the spool. Install large spring (10) on the stem.

<https://www.ebooklibonline.com>

Hello dear friend!

Thank you very much for reading.

Enter the link into your browser.

The full manual is available for immediate download.

<https://www.ebooklibonline.com>