

Product: COMPACTOR

Model: CB15 COMPACTOR M94

Configuration: CB15 Asphalt Compactor M9400001-UP (MACHINE) POWERED BY C4.4B Engine

Disassembly and Assembly CB13, CB15, and CB16 Asphalt Compactors Machine Systems

Media Number -M0091213-00

Publication Date -01/04/2018

Date Updated -24/04/2018

i06554698

Piston Motor (Vibratory) - Remove and Install

SMCS - 5058-010; 5651-010

Removal Procedure

Table 1

Required Tools			
Tool	Part Number	Part Description	Qty
A	-	Loctite 263 Loctite 270 ⁽¹⁾	-
B	-	Loctite 243	-

⁽¹⁾ EAME Only

Start By:

- a. Engage the steering frame lock.
- b. Release the system pressure.



WARNING

Personal injury can result from hydraulic oil pressure and hot oil.

Hydraulic oil pressure can remain in the hydraulic system after the engine has been stopped. Serious injury can be caused if this pressure is not released before any service is done on the hydraulic system.

Make sure all of the work tools have been lowered to the ground, and the oil is cool before removing any components or lines. Remove the oil

filler cap only when the engine is stopped, and the filler cap is cool enough to touch with your bare hand.

1. Drain the hydraulic oil. Refer to Operation and Maintenance Manual, "Hydraulic System Oil - Change" for the correct draining and filling procedures.

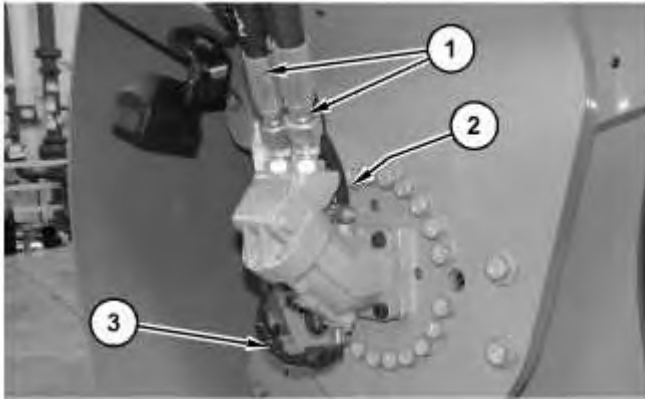

Illustration 1

g06021392

2. Disconnect hose assemblies (1), hose (2), and harness assembly (3).

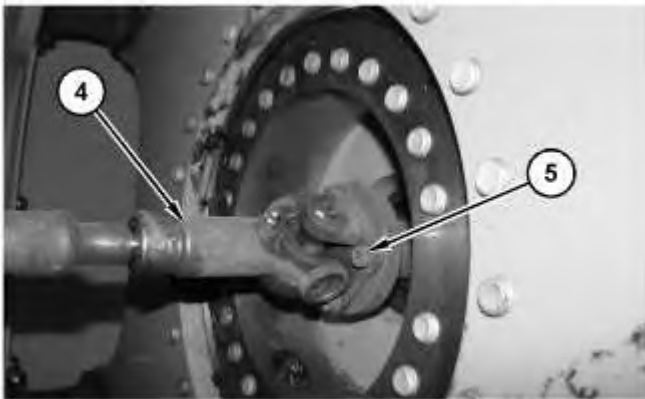

Illustration 2

g06021406

3. Remove bolts (5) and reposition drive shaft (4).
-

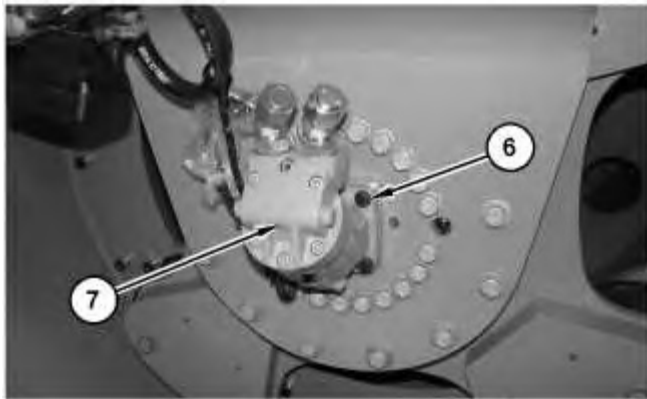

Illustration 3

g06021410

4. Remove bolts (6) and piston motor (7).

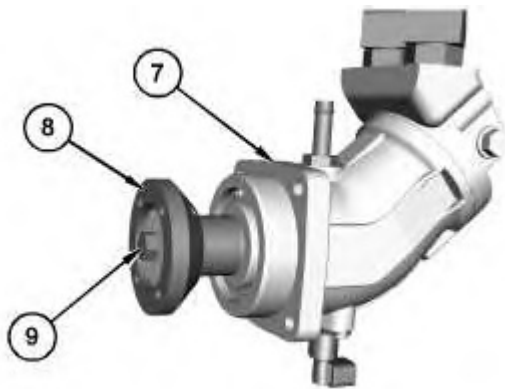

Illustration 4

g06021416

5. Remove bolt (9), the washer, and coupling (8) from piston motor (7).

Installation Procedure

1. Install piston motor (7) in the reverse order of removal.
 - a. Apply Tooling (A) to the threads of bolt (9).
 - b. Apply Tooling (B) to the threads of bolts (5).

<https://www.ebooklibonline.com>

Hello dear friend!

Thank you very much for reading.

Enter the link into your browser.

The full manual is available for immediate download.

<https://www.ebooklibonline.com>

Product: COMPACTOR

Model: CB15 COMPACTOR M94

Configuration: CB15 Asphalt Compactor M9400001-UP (MACHINE) POWERED BY C4.4B Engine

Disassembly and Assembly CB13, CB15, and CB16 Asphalt Compactors Machine Systems

Media Number -M0091213-00

Publication Date -01/04/2018

Date Updated -24/04/2018

i07360061

Final Drive Planetary - Remove and Install

SMCS - 4050-010; 4084-010

Removal Procedure

Table 1

Required Tools			
Tool	Part Number	Part Description	Qty
A	439-3941	Link Bracket As	2
B	439-3939	Link Bracket As	2
C	-	Loctite 243	-

Start By:

- a. Engage the steering frame lock.
- b. Release the system pressure.



WARNING

Personal injury can result from hydraulic oil pressure and hot oil.

Hydraulic oil pressure can remain in the hydraulic system after the engine has been stopped. Serious injury can be caused if this pressure is not released before any service is done on the hydraulic system.

Make sure all of the work tools have been lowered to the ground, and the oil is cool before removing any components or lines. Remove the oil filler cap only when the engine is stopped, and the filler cap is cool enough to touch with your bare hand.

-
1. Drain the hydraulic oil. Refer to Operation and Maintenance Manual, "Hydraulic System Oil - Change" for the correct draining and filling procedures.
 2. Drain the drum drive planetary oil. Refer to Operation and Maintenance Manual, "Drum Drive Planetary Oil - Change" for the correct draining and filling procedures.



Illustration 1

g06020360



Illustration 2

g06294296

3. Attach a suitable lifting device to vibratory compactor (1). Raise vibratory compactor (1).
 4. Position vibratory compactor (1) onto suitable cribbing.
-

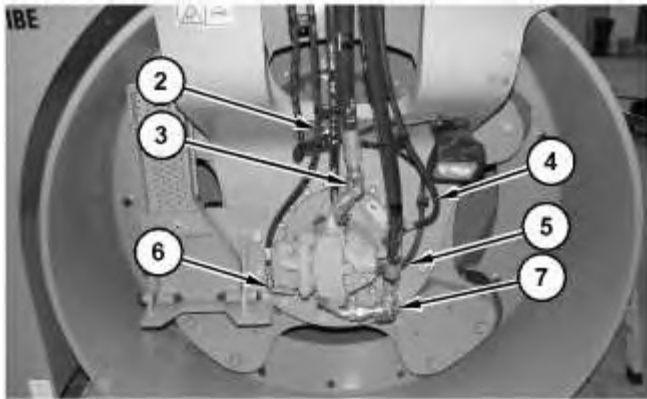

Illustration 3

g06020393

5. Remove bolt (2).
6. Disconnect hose assemblies (3), (4), (6), and (7).
7. Disconnect harness assembly (5).

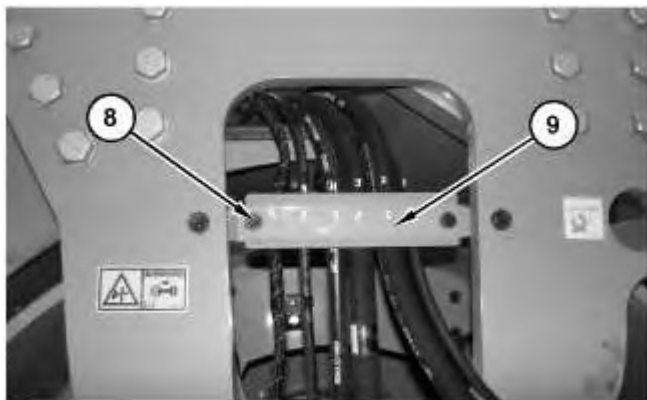

Illustration 4

g06020402

8. Remove bolts (8) and plate (9).

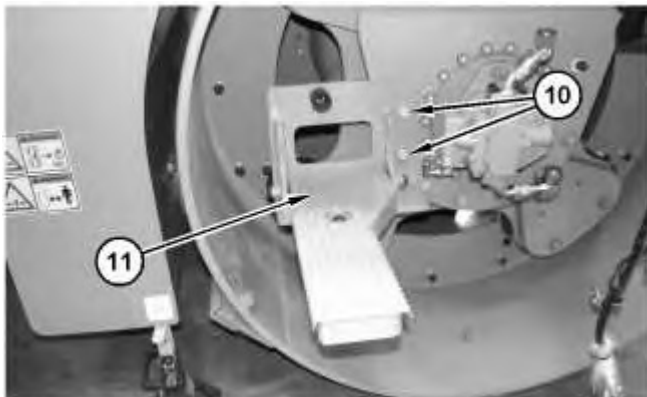

Illustration 5

g06020410

9. Remove bolts (10) and step assembly (11).

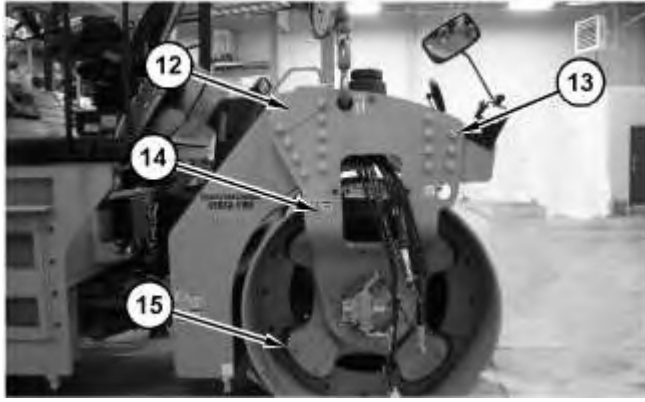

Illustration 6

g06020452

10. Attach a suitable lifting device to support assembly (14). The weight of support assembly (14) is approximately 500 kg (1100 lb).
11. Remove bolts (13) and handle assembly (12).
12. Remove bolts (15) and support assembly (14).

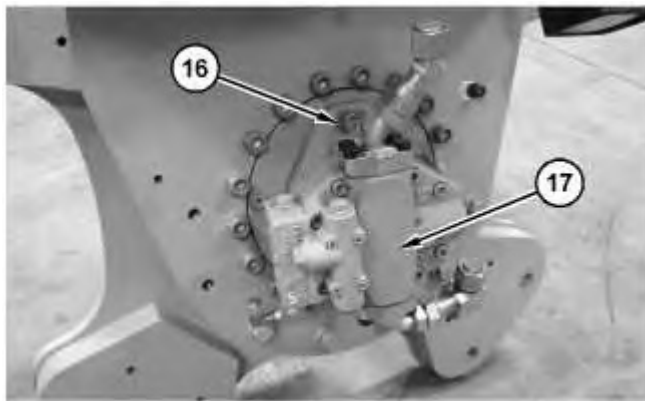

Illustration 7

g06021656

13. Attach a suitable lifting device to piston motor (17). The weight of piston motor (17) is approximately 50 kg (110 lb).
 14. Remove bolts (16) and piston motor (17).
-



Illustration 8

g06021682

15. Attach Tooling (A) and a suitable lifting device to drum support (18). The weight of drum support (18) is approximately 154 kg (340 lb).
16. Remove bolts (19) and drum support (18).



Illustration 9

g06021766

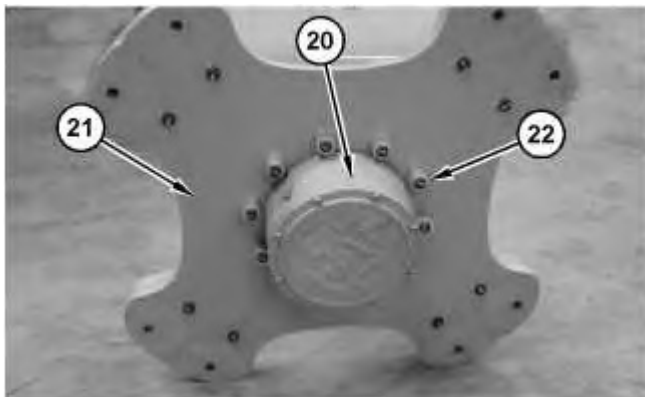

Illustration 10

g06021779

17. Attach Tooling (B) and a suitable lifting device to final drive (20). The weight of final drive (20) is approximately 85 kg (187 lb).

18. Remove nuts (22). Remove final drive (20) from plate (21).

Installation Procedure

1. Install final drive (20) in the reverse order of removal.
 - a. Tighten nuts (22) to a torque of $680 \pm 60 \text{ N}\cdot\text{m}$ ($502 \pm 44 \text{ lb ft}$).
 - b. Apply Tooling (C) to the threads of bolts (19).
-

Product: COMPACTOR

Model: CB15 COMPACTOR M94

Configuration: CB15 Asphalt Compactor M9400001-UP (MACHINE) POWERED BY C4.4B Engine

Disassembly and Assembly CB13, CB15, and CB16 Asphalt Compactors Machine Systems

Media Number -M0091213-00

Publication Date -01/04/2018

Date Updated -24/04/2018

i07332262

Final Drive Planetary - Disassemble

SMCS - 4050-015; 4084-015

Disassembly Procedure

Start By:

- a. Remove the final drive planetary.

Table 1

Required Tools			
Tool	Part Number	Part Description	Qty
A	150-1782	Crossblock	1
	1U-5230	Hydraulic Pump Assembly	1
	126-7179	Puller Leg	2
	4C-4660	Adapter-Threaded	2
	3H-0465	Push-Puller Plate	4
	360-6956	Hydraulic Cylinder	1
B	6V-8359	Bolt	2
C	1P-2420	Transmission Repair Stand	1
D	1U-6400	Three Jaw Puller	1
E	8B-7554	Bearing Cup Puller Gp	1
	1P-0510	Driver Gp	1
F	6V-6080	Torque Multiplier Gp	1
	524-2773	Socket As	1

G	1U-9889	Crossblock	1
	4C-5660	Adapter-Threaded	2
	5F-7369	Puller Leg	2
	3H-0465	Push-Puller Plate	2
	5P-5247	Hydraulic Puller As	1
H	439-3939	Link Bracket As	3
J	1U-9889	Crossblock	1
	3H-0469	Leg	2
	3H-0465	Push-Puller Plate	4
	1P-0520	Driver Gp	1
	360-6964	Hydraulic Cylinder	1
	1U-5230	Hydraulic Pump Assembly	1

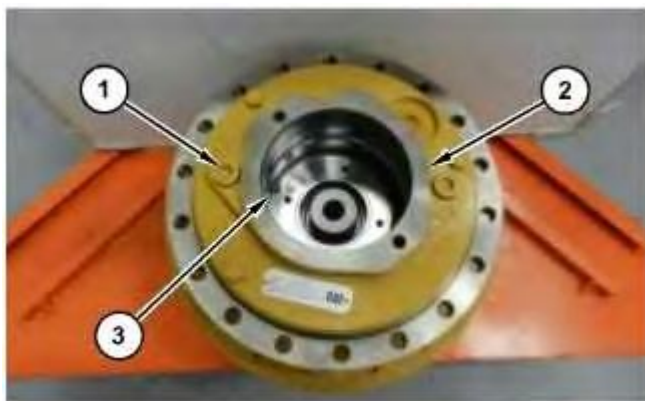

Illustration 1

g06172670

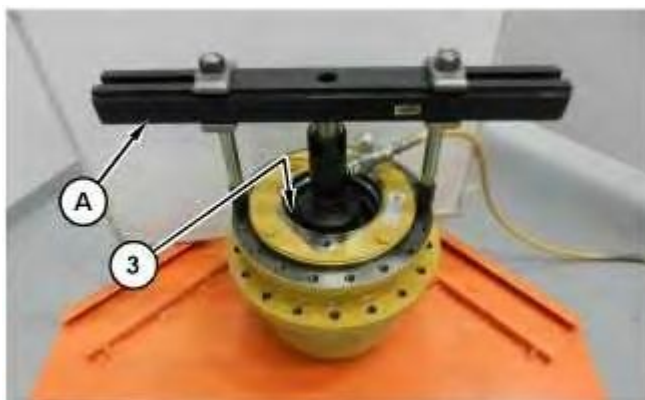

Illustration 2

g06172710

WARNING

Personal injury can result from being struck by parts propelled by a released spring force.

Make sure to wear all necessary protective equipment.

Follow the recommended procedure and use all recommended tooling to release the spring force.

1. Remove bolts (1), flange (2), and the O-ring seal.
2. Use Tooling (A) to compress the plate away from retaining ring (3).
3. Remove retaining ring (3) and release pressure from Tooling (A). Remove Tooling (A).

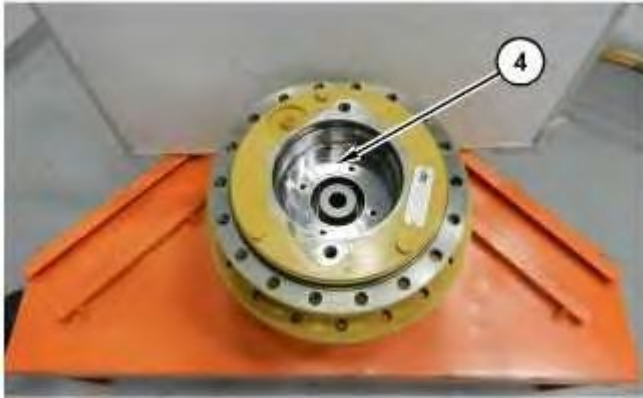

Illustration 3

g06172716

4. Remove plate (4).

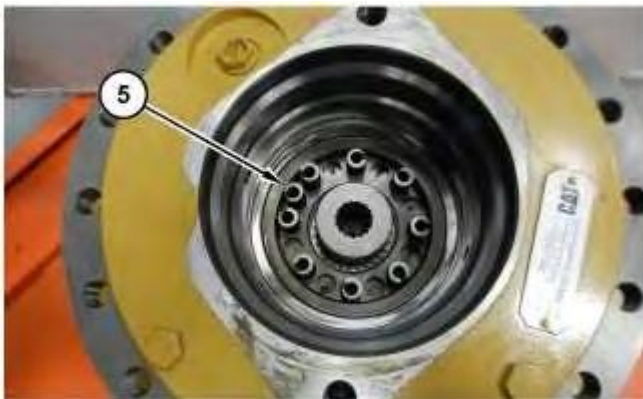

Illustration 4

g06172729

5. Remove springs (5).
-

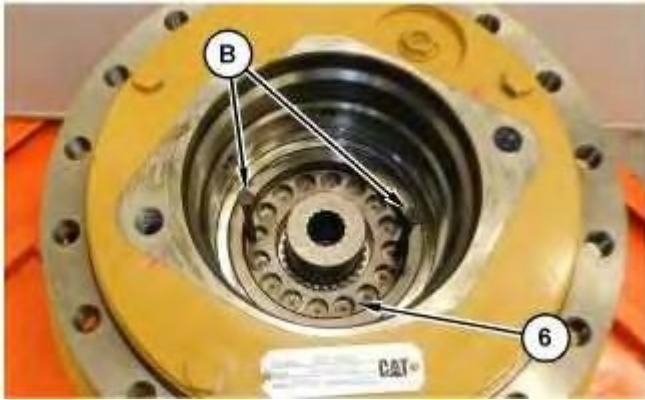

Illustration 5

g06172730

6. Use Tooling (B) to remove piston (6).



Illustration 6

g06172740

7. Remove discs (7) and the shims.



Illustration 7

g06172742

8. Remove backup rings (8) and O-ring seals (9).

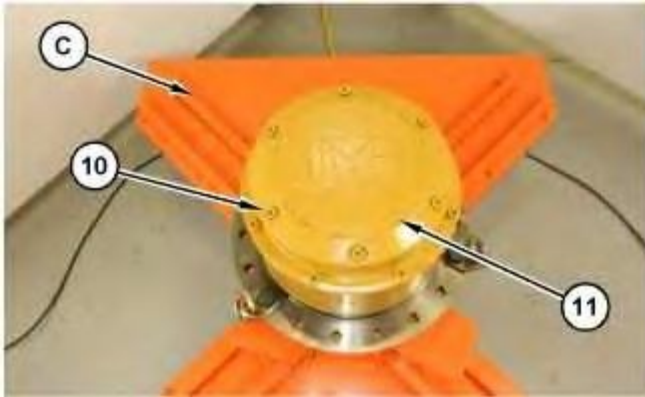

Illustration 8

g06172653

9. Secure the final drive to Tooling (C) or a suitable bench. The weight of the final drive is approximately 110 kg (243 lb).
10. Remove bolts (10) and cover (11).

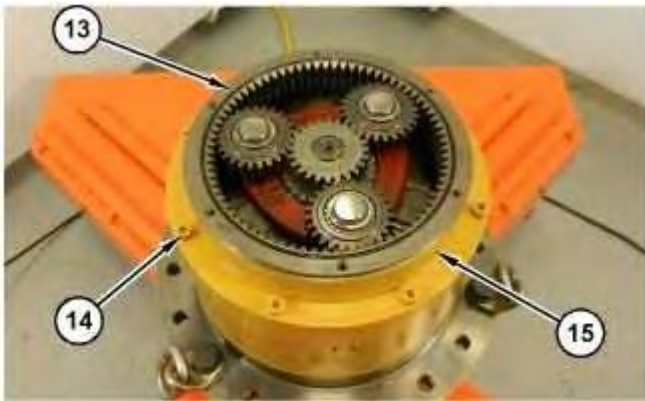

Illustration 9

g06172743

11. Remove O-ring seal (13), bolts (14), and gear (15).



Illustration 10

g06172748

12. Remove O-ring seal (16) from gear (15).



Illustration 11

g06172753

13. Remove gear (17) and carrier assembly (18).

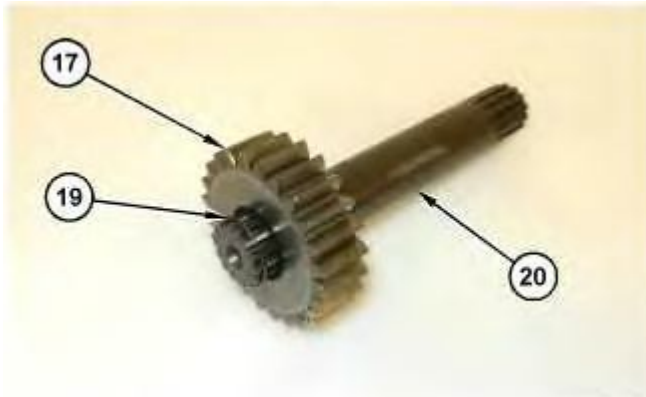

Illustration 12

g06172755

14. Remove retaining ring (19) and gear (17) from shaft (20).



Illustration 13

g06172752

15. Remove retaining rings (21).

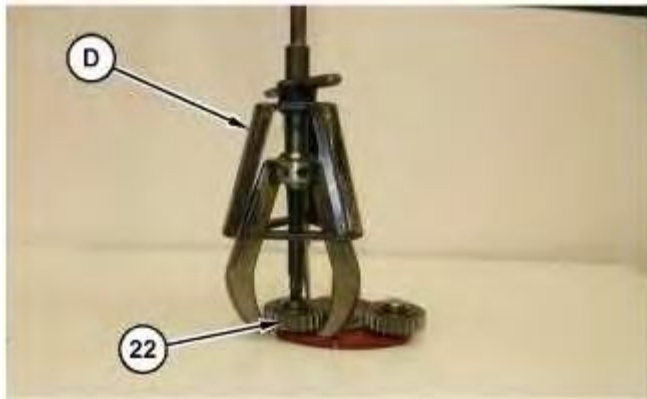

Illustration 14

g06172757

16. Use Tooling (D) to remove gears (22).

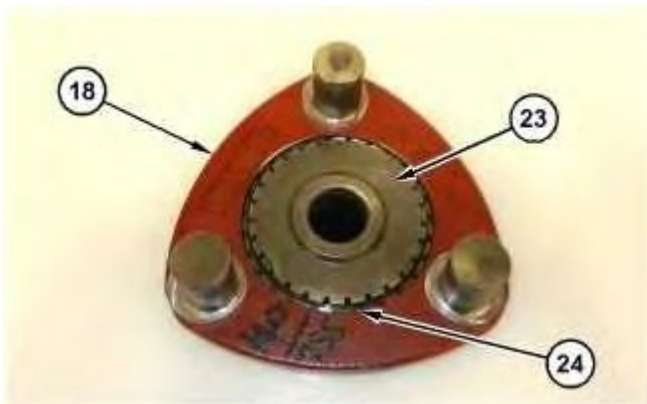

Illustration 15

g06172761

17. Remove retaining ring (24) and gear (23) from carrier assembly (18).



Illustration 16

g06172762

18. Remove carrier assembly (25).



Illustration 17

g06172766

19. Remove spacer (26) and retaining rings (27) from carrier assembly (25).

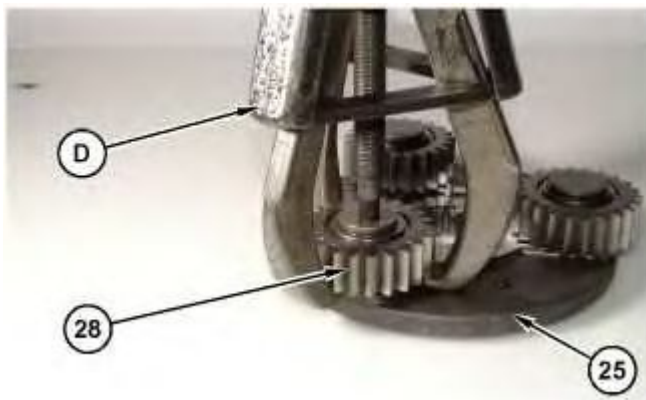

Illustration 18

g06172767

20. Use Tooling (B) to remove gears (28) from carrier assembly (25).



Illustration 19

g06172771

21. Remove gear (29).
-



Illustration 20

g06172772

22. Use pry bars to remove gear (30).



Illustration 21

g06172773

23. Remove retaining rings (31).



Illustration 22

g06172774

24. Use Tooling (E) to remove gears (32).



Illustration 23

g06172775



Illustration 24

g06172776



Personal injury can result from being struck by parts propelled by a released spring force.

Make sure to wear all necessary protective equipment.

Follow the recommended procedure and use all recommended tooling to release the spring force.

25. Use Tooling (F) to remove bearing locknut (33).



Illustration 25

g06172777



Illustration 26

g06172778

26. Use Tooling (G) to separate hub (34).
27. Use Tooling (H) and a suitable lifting device to remove hub (34). The weight of hub (34) is approximately 37 kg (80 lb).



Illustration 27

g06172910

28. Remove bearing cone (35) from hub (34).



Suggest:

For more complete manuals. Please go to the home page.

<https://www.ebooklibonline.com>

If the above button click is invalid. Please download this document first, and then click the above link to download the complete manual.

Thank you so much for reading



Illustration 28

g06172779

29. Remove duo-cone seal (36) from hub (34).



Illustration 29

g06172906

30. Remove bearing cups (37) from hub (34).



Illustration 30

g06173076

31. Use Tooling (J) to remove spacer (38) and bearing cone (39).



Illustration 31

g06173085

32. Remove duo-cone seal (40) from spindle (41).



Illustration 32

g06173089

33. Remove retaining ring (42) from spindle (41).
34. Use a soft faced hammer to remove shaft assembly (43) from the opposite side on spindle (41).



Illustration 33

g06173098

35. Remove retaining ring (44) and roller bearing (45) from shaft assembly (43).

<https://www.ebooklibonline.com>

Hello dear friend!

Thank you very much for reading.

Enter the link into your browser.

The full manual is available for immediate download.

<https://www.ebooklibonline.com>