

Product: BACKHOE LOADER

Model: 416E BACKHOE LOADER LMS

Configuration: 416E Backhoe Loader Single Tilt LMS00001-UP (MACHINE) POWERED BY C4.4 Engine

Operation and Maintenance Manual

416E Backhoe Loader

Media Number -SEBU8698-06

Publication Date -01/02/2015

Date Updated -26/02/2015

s00037320

Foreword

Literature Information

This manual should be stored in the operator's compartment in the literature holder or seat back literature storage area.

This manual contains safety information, operation instructions, transportation information, lubrication information and maintenance information.

Some photographs or illustrations in this publication show details or attachments that can be different from your machine. Guards and covers might have been removed for illustrative purposes.

Continuing improvement and advancement of product design might have caused changes to your machine which are not included in this publication. Read, study and keep this manual with the machine.

Whenever a question arises regarding your machine, or this publication, please consult your Cat dealer for the latest available information.

Safety

The safety section lists basic safety precautions. In addition, this section identifies the text and locations of warning signs and labels used on the machine.

Read and understand the basic precautions listed in the safety section before operating or performing lubrication, maintenance and repair on this machine.

Operation

The operation section is a reference for the new operator and a refresher for the experienced operator. This section includes a discussion of gauges, switches, machine controls, attachment controls, transportation and towing information.

Photographs and illustrations guide the operator through correct procedures of checking, starting, operating and stopping the machine.

Operating techniques outlined in this publication are basic. Skill and techniques develop as the operator gains knowledge of the machine and its capabilities.

Maintenance

The maintenance section is a guide to equipment care. The Maintenance Interval Schedule (MIS) lists the items to be maintained at a specific service interval. Items without specific intervals are listed under the "When Required" service interval. The Maintenance Interval Schedule lists the page number for the step-by-step instructions required to accomplish the scheduled maintenance. Use the Maintenance Interval Schedule as an index or "one safe source" for all maintenance procedures.

Maintenance Intervals

Use the service hour meter to determine servicing intervals. Calendar intervals shown (daily, weekly, monthly, etc.) can be used instead of service hour meter intervals if they provide more convenient servicing schedules and approximate the indicated service hour meter reading. Recommended service should always be performed at the interval that occurs first.

Under extremely severe, dusty or wet operating conditions, more frequent lubrication than is specified in the maintenance intervals chart might be necessary.

Perform service on items at multiples of the original requirement. For example, at every 500 service hours or 3 months, also service those items listed under every 250 service hours or monthly and every 10 service hours or daily.

California Proposition 65 Warning

Diesel engine exhaust and some of its constituents are known to the State of California to cause cancer, birth defects, and other reproductive harm.

Battery posts, terminals and related accessories contain lead and lead compounds. **Wash hands after handling.**

Certified Engine Maintenance

Proper maintenance and repair is essential to keep the engine and machine systems operating correctly. As the heavy duty off-road diesel engine owner, you are responsible for the performance of the required maintenance listed in the Owner Manual, Operation and Maintenance Manual, and Service Manual.

It is prohibited for any person engaged in the business of repairing, servicing, selling, leasing, or trading engines or machines to remove, alter, or render inoperative any emission related device or element of design installed on or in an engine or machine that is in compliance with the regulations (40 CFR Part 89). Certain elements of the machine and engine such as the exhaust system, fuel system, electrical system, intake air system and cooling system may be emission related and should not be altered unless approved by Caterpillar.

Machine Capacity

Additional attachments or modifications may exceed machine design capacity which can adversely affect performance characteristics. Included would be stability and system certifications such as brakes, steering, and rollover protective structures (ROPS). Contact your Cat dealer for further information.

Cat Product Identification Number

Effective First Quarter 2001 the Cat Product Identification Number (PIN) has changed from 8 to 17 characters. In an effort to provide uniform equipment identification, Caterpillar and other construction equipment manufacturers are moving to comply with the latest version of the product identification numbering standard. Non-road machine PINs are defined by ISO 10261. The new PIN format will apply to all Cat machines and generator sets. The PIN plates and frame marking will display the 17 character PIN. The new format will look like the following:



Illustration 1

g00751314

Where:

1. Caterpillar's World Manufacturing Code (characters 1-3)
2. Machine Descriptor (characters 4-8)
3. Check Character (character 9)
4. Machine Indicator Section (MIS) or Product Sequence Number (characters 10-17). These were previously referred to as the Serial Number.

Machines and generator sets produced before First Quarter 2001 will maintain their 8 character PIN format.

<https://www.ebooklibonline.com>

Hello dear friend!

Thank you very much for reading.

Enter the link into your browser.

The full manual is available for immediate download.

<https://www.ebooklibonline.com>

Components such as engines, transmissions, axles, etc. and work tools will continue to use an 8 character Serial Number (S/N).

There are several specific safety messages on this machine. The exact location of the hazards and the description of the hazards are reviewed in this section. Please become familiarized with all safety messages.

Make sure that all of the safety messages are legible. Clean the safety messages or replace the safety messages if you cannot read the words. Replace the illustrations if the illustrations are not legible. When you clean the safety messages, use a cloth, water, and soap. Do not use solvent, gasoline, or other harsh chemicals to clean the safety messages. Solvents, gasoline, or harsh chemicals could loosen the adhesive that secures the safety message. Loose adhesive will allow the safety message to fall.

Replace any safety message that is damaged, or missing. If a safety message is attached to a part that is replaced, install a safety message on the replacement part. Any Cat dealer can provide new safety messages.

Do Not Operate (1)



Illustration 2

g01370904

This safety message is located under the engine start switch.



Do not operate or work on this machine unless you have read and understand the instructions and warnings in the Operation and Maintenance Manuals. Failure to follow the instructions or heed the warnings could result in injury or death. Contact your Cat dealer for replacement manuals. Proper care is your responsibility.

No Ether In Air Inlet (2)



Illustration 3

g01372254

This safety message is located on the air filter cover.

! WARNING

If equipped with an air inlet heater (AIH) for cold weather starting, do not use aerosol types of starting aids such as ether. Such use could result in an explosion and personal injury.

Proper Connections for Jump Start Cables (3)



Illustration 4

g01370909

This safety message is located on the inside of the door for the battery compartment.

! WARNING

Explosion Hazard! Improper jumper cable connections can cause an explosion resulting in serious injury or death. Batteries may be located in separate compartments. When using jump start cables, always

connect the positive (+) cable from the source to the positive (+) terminal of the battery that is connected to the starter solenoid. Connect the negative (-) cable from the source to the negative (-) terminal of the starter. If the machine is not equipped with a starter negative terminal, connect the negative (-) cable to the engine block. Follow the procedure in the Operation and Maintenance Manual.

ROPS (4)



Illustration 5

g01113333

This safety message is located on the cab next to the left side door.



Structural damage, an overturn, modification, alteration, or improper repair can impair this structure's protection capability thereby voiding this certification. Do not weld on or drill holes in the structure. Consult a Caterpillar dealer to determine this structure's limitations without voiding its certification.

Crush Hazard (5)

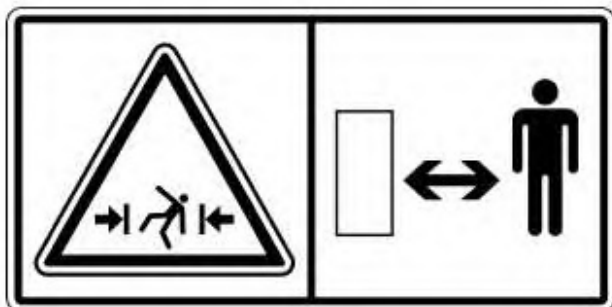

Illustration 6

g01371644

This safety message is located on the boom above the boom foot pin.

 **WARNING**

Crushing Hazard! Stay back a safe distance. There is no clearance for a person in this area when the machine turns. Failure to follow these instructions could cause serious injury or death.

No Exit (6)

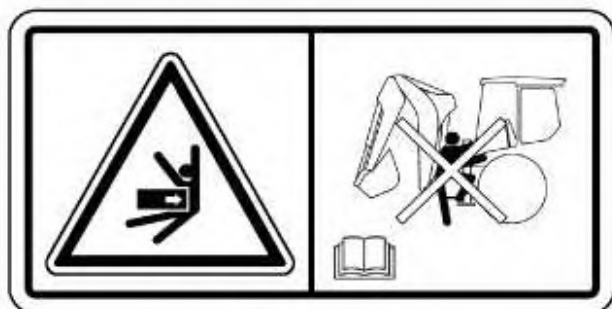

Illustration 7

g01407377

This safety message is located on the back of the cab.

 **WARNING**

Crush hazard; This is not an entrance or exit. Stay clear of this area when the machine is operating. Start and operate the backhoe from the operator seat only. Failure to follow these warnings could result in injury or death.

Brace The Lift Cylinder (7)



Illustration 8

g01407376

This safety message is located on the brace for the loader lift arm.

WARNING

When performing any work underneath a raised loader lift arm, the loader lift arm brace must be in place. Install the loader lift arm brace as follows.

- 1. Empty loader bucket. Remove pin that secures loader lift arm brace to left loader arm. Raise the loader arms with the bucket in the dump position.**
- 2. Position service brace over left lift cylinder with flat end against cylinder end.**
- 3. Push pin through holes of loader lift arm brace and install cotter pin.**
- 4. Slowly lower loader arms until brace contacts the top of the lift cylinder and bosses on loader arm.**
- 5. To remove loader lift arm brace, reverse procedure.**

Failure to follow this procedure can result in death or serious injury if the loader arms are accidentally lowered.

Refer to Operation and Maintenance Manual, "Lift Cylinder Brace - Connect and Disconnect" for more information.

Pressurized System (8)

This safety message is located on the cooling system filler cap.



g01370913



Pressurized system: Hot coolant can cause serious burn. To open cap, stop engine, wait until radiator is cool. Then loosen cap slowly to relieve the pressure.

High Cylinder Pressure (9)

This safety message is located on both sides of the boom near the connection with the stick.

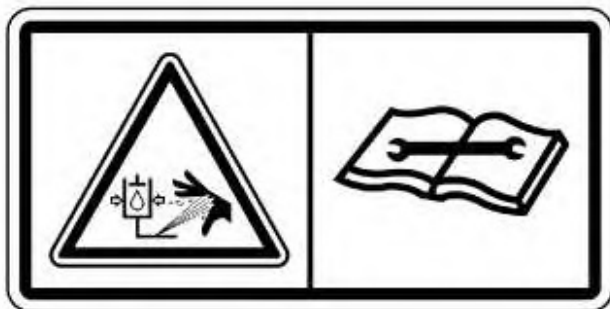

g01407379

! WARNING

High Pressure Cylinder. Failure to read and follow these instructions can cause rapidly discharging gas and/or hydraulic fluid which can result in death, personal injury and property damage.

Seat Belt (10)



Illustration 9

g01370908

This safety message is located above the engine start switch.

! WARNING

A seat belt should be worn at all times during machine operation to prevent serious injury or death in the event of an accident or machine overturn. Failure to wear a seat belt during machine operation may result in serious injury or death.

High Pressure Accumulator (11)

This safety message is located next to the accumulator if the machine is equipped with the option for ride control. The accumulator is located behind the battery box.

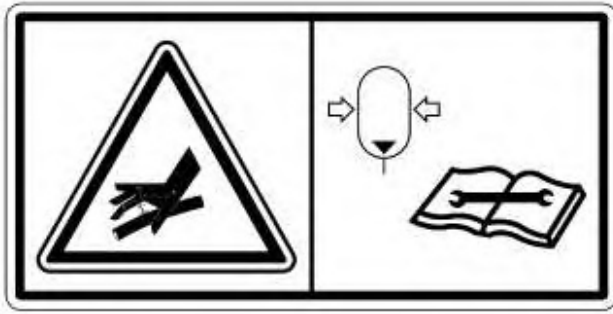

g01370912

! WARNING

Hydraulic accumulator contains gas and oil under high pressure. Improper removal or repair procedures could cause severe injury. To remove or repair, instructions in the service manual must be followed. Special equipment is required for testing and charging.

Product Link (12) (If Equipped)

This safety message is located in the front of the cab on the left post.



g01381177

! WARNING

This machine is equipped with a Caterpillar Product Link communication device. When electric detonators are used, this communication device should be deactivated within 12 m (40 ft) of a blast site for satellite-based systems and within 3 m (10 ft) of a blast site for cellular based systems, or within the distance mandated under applicable legal requirements. Failure to do so could cause interference with blasting operations and result in serious injury or death.

In cases where the type of Product Link module cannot be identified, Caterpillar recommends that the device be disabled no less than 12 m (40 ft) from the blast perimeter.

Object Handling Stability (13) (If Equipped)

This safety message is located on the right of the cab on the console.

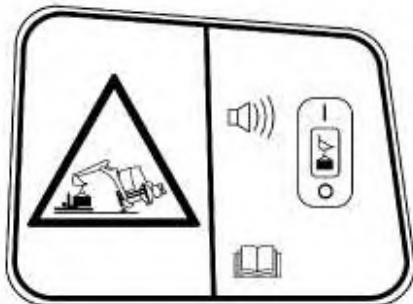

g01957323

 **WARNING**

Overloading the machine could impact the machine's stability which could result in a tip over hazard. A tip over hazard could result in serious injury or death. Always activate the stability alarm switch before you handle or lift objects.

Product: BACKHOE LOADER

Model: 416E BACKHOE LOADER LMS

Configuration: 416E Backhoe Loader Single Tilt LMS00001-UP (MACHINE) POWERED BY C4.4 Engine

Operation and Maintenance Manual 416E Backhoe Loader

Media Number -SEBU8698-06

Publication Date -01/02/2015

Date Updated -26/02/2015

i02897596

Additional Messages

SMCS - 7000; 7405

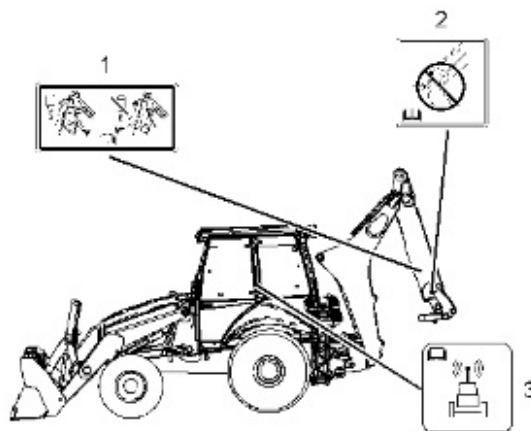

Illustration 1

g01442834

Pinning of the Extendable Stick (1)

If equipped, this message is located on the stick.

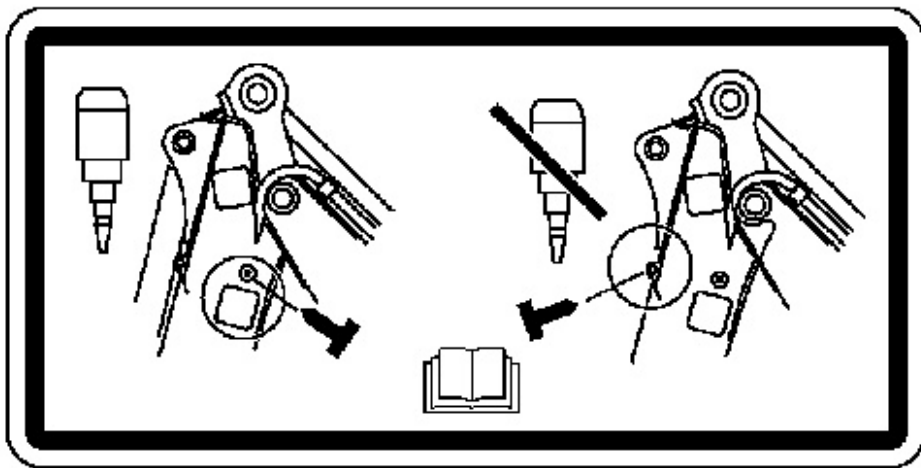

Illustration 2

g01202535

⚠ CAUTION

The E-Stick must be pinned before using attachments, to prevent movement which could cause personal injury.

Improper Location of the Backhoe Bucket (2)

This message is located by the linkage for the backhoe bucket.

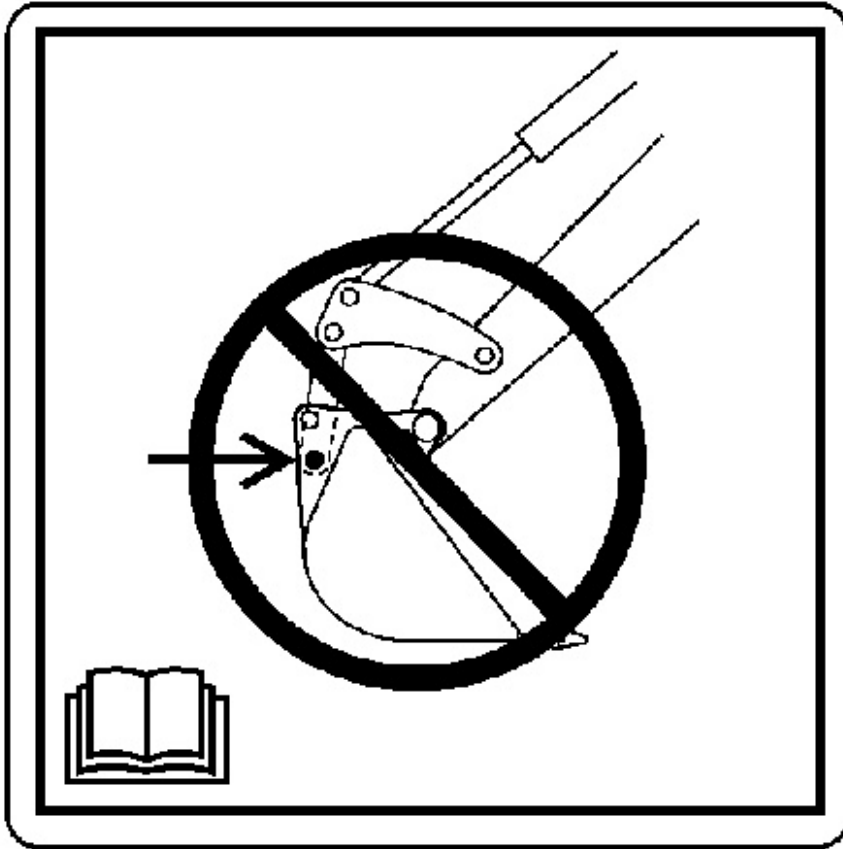

Illustration 3

g01202537



Improper bucket pin connection can cause machine damage. Make sure the bucket pins are connected properly.

Data Privacy (3)

This message is located in the cab.



Product: BACKHOE LOADER

Model: 416E BACKHOE LOADER LMS

Configuration: 416E Backhoe Loader Single Tilt LMS00001-UP (MACHINE) POWERED BY C4.4 Engine

Operation and Maintenance Manual 416E Backhoe Loader

Media Number -SEBU8698-06

Publication Date -01/02/2015

Date Updated -26/02/2015

i07500894

General Hazard Information

SMCS - 7000

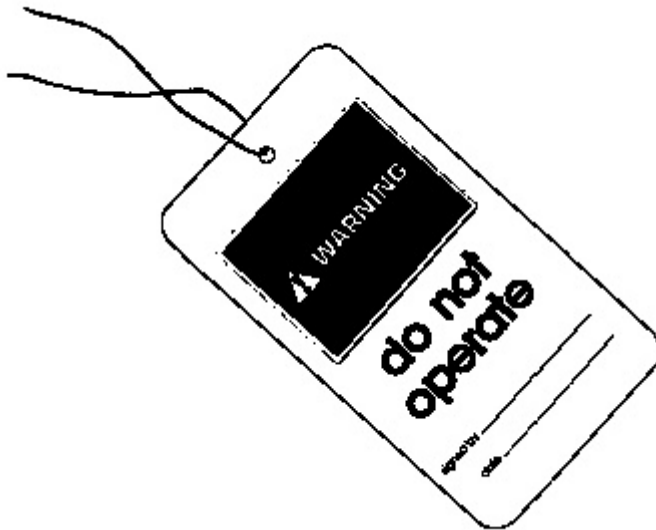

Illustration 1

g00104545

Typical example

Attach a "Do Not Operate" warning tag or a similar warning tag to the start switch or to the controls. Attach the warning tag before you service the equipment or before you repair the equipment. Warning tag SEHS7332 is available from your Cat dealer.



Operating the machine while distracted can result in the loss of machine control. Use extreme caution when using any device while operating the

machine. Operating the machine while distracted can result in personal injury or death.

Know the width of your equipment in order to maintain proper clearance when you operate the equipment near fences or near boundary obstacles.

Be aware of high voltage power lines and power cables that are buried. If the machine comes in contact with these hazards, serious injury or death may occur from electrocution.

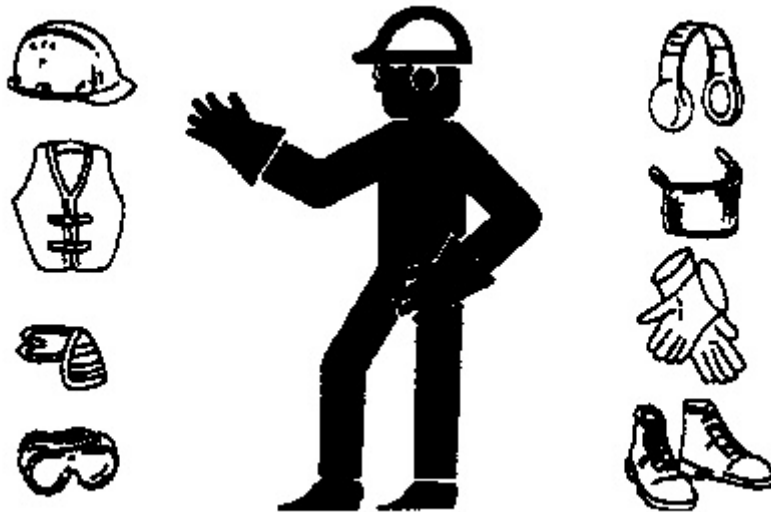

Illustration 2

g00702020

Wear a hard hat, protective glasses, and other protective equipment, as required.

Do not wear loose clothing or jewelry that can snag on controls or on other parts of the equipment.

Make sure that all protective guards and all covers are secured in place on the equipment.

Keep the equipment free from foreign material. Remove debris, oil, tools, and other items from the deck, from walkways, and from steps.

Secure all loose items such as lunch boxes, tools, and other items that are not a part of the equipment.

Know the appropriate work site hand signals and the personnel that are authorized to give the hand signals. Accept hand signals from one person only.

Do not smoke when you service an air conditioner. Also, do not smoke if refrigerant gas may be present. Inhaling the fumes that are released from a flame that contacts air conditioner refrigerant can cause bodily harm or death. Inhaling gas from air conditioner refrigerant through a lighted cigarette can cause bodily harm or death.

Never put maintenance fluids into glass containers. Drain all liquids into a suitable container.

Obey all local regulations for the disposal of liquids.

Use all cleaning solutions with care. Report all necessary repairs.

Do not allow unauthorized personnel on the equipment.

Unless you are instructed otherwise, perform maintenance with the equipment in the servicing position. Refer to Operation and Maintenance Manual for the procedure for placing the equipment in the servicing position.

When you perform maintenance above ground level, use appropriate devices such as ladders or man lift machines. If equipped, use the machine anchorage points and use approved fall arrest harnesses and lanyards.

Pressurized Air and Water

Pressurized air and/or water can cause debris and/or hot water to be blown out. The debris and/or hot water could result in personal injury.

When pressurized air and/or pressurized water is used for cleaning, wear protective clothing, protective shoes, and eye protection. Eye protection includes goggles or a protective face shield.

The maximum air pressure for cleaning purposes must be reduced to 205 kPa (30 psi) when the nozzle is deadheaded and the nozzle is used with an effective chip deflector and personal protective equipment. The maximum water pressure for cleaning purposes must be below 275 kPa (40 psi).

Avoid direct spraying of water on electrical connectors, connections, and components. When using air for cleaning, allow the machine to cool to reduce the possibility of fine debris igniting when re-deposited on hot surfaces.

Trapped Pressure

Pressure can be trapped in a hydraulic system. Releasing trapped pressure can cause sudden machine movement or attachment movement. Use caution if you disconnect hydraulic lines or fittings. High-pressure oil that is released can cause a hose to whip. High-pressure oil that is released can cause oil to spray. Fluid penetration can cause serious injury and possible death.

Fluid Penetration

Pressure can be trapped in the hydraulic circuit long after the machine has been stopped. The pressure can cause hydraulic fluid or items such as pipe plugs to escape rapidly if the pressure is not relieved correctly.

Do not remove any hydraulic components or parts until pressure has been relieved or personal injury may occur. Do not disassemble any hydraulic components or parts until pressure has been relieved or personal injury may occur. Refer to the Service Manual for any procedures that are required to relieve the hydraulic pressure.



Suggest:

For more complete manuals. Please go to the home page.

<https://www.ebooklibonline.com>

If the above button click is invalid. Please download this document first, and then click the above link to download the complete manual.

Thank you so much for reading

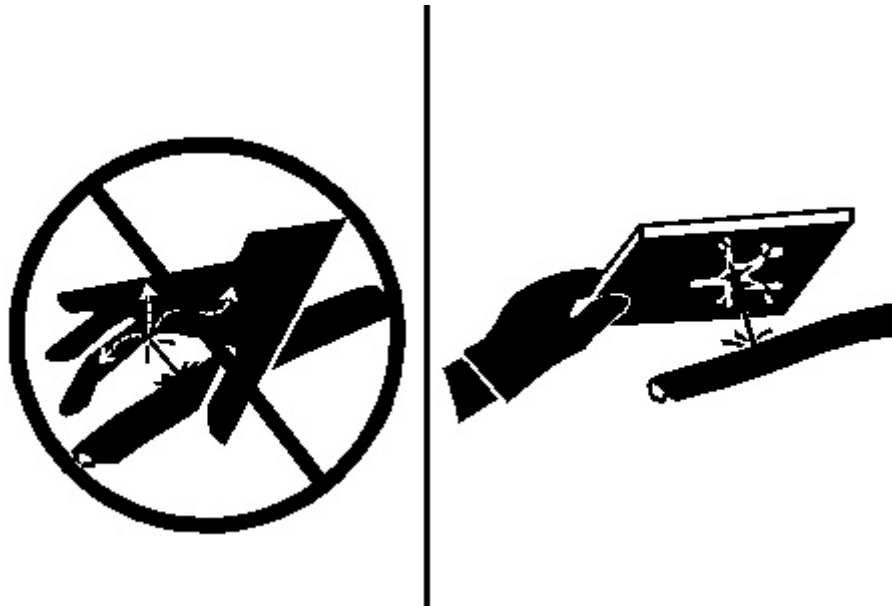

Illustration 3

g00687600

Always use a board or cardboard when you check for a leak. Leaking fluid that is under pressure can penetrate body tissue. Fluid penetration can cause serious injury and possible death. A pin hole leak can cause severe injury. If fluid is injected into your skin, you must get treatment immediately. Seek treatment from a doctor that is familiar with this type of injury.

Containing Fluid Spillage

Care must be taken in order to ensure that fluids are contained during performance of inspection, maintenance, testing, adjusting, and repair of the equipment. Prepare to collect the fluid with suitable containers before opening any compartment or disassembling any component that contains fluids.

Refer to Special Publication, NENG2500, "Cat dealer Service Tool Catalog" for the following items:

- Tools that are suitable for collecting fluids and equipment that is suitable for collecting fluids
- Tools that are suitable for containing fluids and equipment that is suitable for containing fluids

Obey all local regulations for the disposal of liquids.

Inhalation

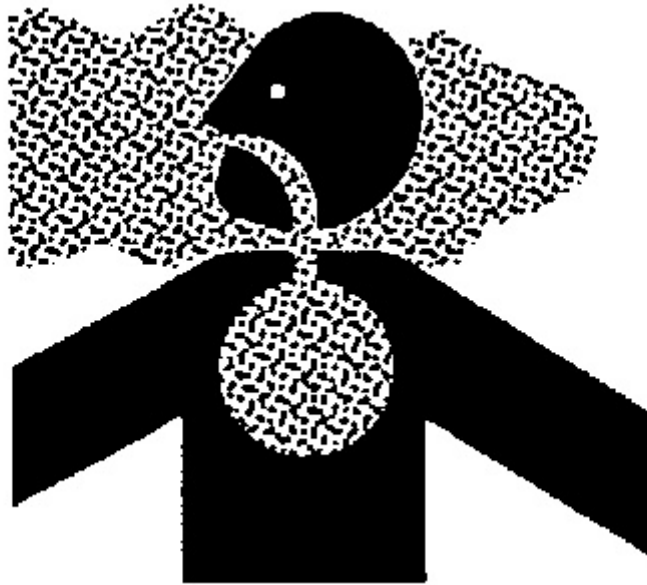

Illustration 4

g02159053

Exhaust

Use caution. Exhaust fumes can be hazardous to your health. If you operate the machine in an enclosed area, adequate ventilation is necessary.

Asbestos Information

Cat equipment and replacement parts that are shipped from Caterpillar are asbestos free. Caterpillar recommends the use of only genuine Cat replacement parts. Use the following guidelines when you handle any replacement parts that contain asbestos or when you handle asbestos debris.

Use caution. Avoid inhaling dust that might be generated when you handle components that contain asbestos fibers. Inhaling this dust can be hazardous to your health. The components that may contain asbestos fibers are brake pads, brake bands, lining material, clutch plates, and some gaskets. The asbestos that is used in these components is bound in a resin or sealed in some way. Normal handling is not hazardous unless airborne dust that contains asbestos is generated.

If dust that may contain asbestos is present, there are several guidelines that should be followed:

- Never use compressed air for cleaning.
- Avoid brushing materials that contain asbestos.
- Avoid grinding materials that contain asbestos.
- Use a wet method in order to clean up asbestos materials.
- A vacuum cleaner that is equipped with a high efficiency particulate air filter (HEPA) can also be used.
- Use exhaust ventilation on permanent machining jobs.

<https://www.ebooklibonline.com>

Hello dear friend!

Thank you very much for reading.

Enter the link into your browser.

The full manual is available for immediate download.

<https://www.ebooklibonline.com>