

Product: EXCAVATOR

Model: 312C EXCAVATOR FDS

Configuration: 312C & 312C L Excavators FDS00301-UP (MACHINE) POWERED BY 3064 Engine

Operation and Maintenance Manual 312C Excavator

Media Number -SEBU7424-06

Publication Date -01/04/2007

Date Updated -04/04/2007

s00037320

Foreword

SMCS - 7606

Literature Information

This manual should be stored in the operator's compartment in the literature holder or seat back literature storage area.

This manual contains safety information, operation instructions, transportation information, lubrication information and maintenance information.

Some photographs or illustrations in this publication show details or attachments that can be different from your machine. Guards and covers might have been removed for illustrative purposes.

Continuing improvement and advancement of product design might have caused changes to your machine which are not included in this publication. Read, study and keep this manual with the machine.

Whenever a question arises regarding your machine, or this publication, please consult your Cat dealer for the latest available information.

Safety

The safety section lists basic safety precautions. In addition, this section identifies the text and locations of warning signs and labels used on the machine.

Read and understand the basic precautions listed in the safety section before operating or performing lubrication, maintenance and repair on this machine.

Operation

The operation section is a reference for the new operator and a refresher for the experienced operator. This section includes a discussion of gauges, switches, machine controls, attachment controls, transportation and towing information.

Photographs and illustrations guide the operator through correct procedures of checking, starting, operating and stopping the machine.

Operating techniques outlined in this publication are basic. Skill and techniques develop as the operator gains knowledge of the machine and its capabilities.

Maintenance

The maintenance section is a guide to equipment care. The Maintenance Interval Schedule (MIS) lists the items to be maintained at a specific service interval. Items without specific intervals are listed under the "When Required" service interval. The Maintenance Interval Schedule lists the page number for the step-by-step instructions required to accomplish the scheduled maintenance. Use the Maintenance Interval Schedule as an index or "one safe source" for all maintenance procedures.

Maintenance Intervals

Use the service hour meter to determine servicing intervals. Calendar intervals shown (daily, weekly, monthly, etc.) can be used instead of service hour meter intervals if they provide more convenient servicing schedules and approximate the indicated service hour meter reading. Recommended service should always be performed at the interval that occurs first.

Under extremely severe, dusty or wet operating conditions, more frequent lubrication than is specified in the maintenance intervals chart might be necessary.

Perform service on items at multiples of the original requirement. For example, at every 500 service hours or 3 months, also service those items listed under every 250 service hours or monthly and every 10 service hours or daily.

California Proposition 65 Warning

Diesel engine exhaust and some of its constituents are known to the State of California to cause cancer, birth defects, and other reproductive harm.

Battery posts, terminals and related accessories contain lead and lead compounds. **Wash hands after handling.**

Certified Engine Maintenance

Proper maintenance and repair is essential to keep the engine and machine systems operating correctly. As the heavy duty off-road diesel engine owner, you are responsible for the performance of the required maintenance listed in the Owner Manual, Operation and Maintenance Manual, and Service Manual.

It is prohibited for any person engaged in the business of repairing, servicing, selling, leasing, or trading engines or machines to remove, alter, or render inoperative any emission related device or element of design installed on or in an engine or machine that is in compliance with the

regulations (40 CFR Part 89). Certain elements of the machine and engine such as the exhaust system, fuel system, electrical system, intake air system and cooling system may be emission related and should not be altered unless approved by Caterpillar.

Machine Capacity

Additional attachments or modifications may exceed machine design capacity which can adversely affect performance characteristics. Included would be stability and system certifications such as brakes, steering, and rollover protective structures (ROPS). Contact your Cat dealer for further information.

Cat Product Identification Number

Effective First Quarter 2001 the Cat Product Identification Number (PIN) has changed from 8 to 17 characters. In an effort to provide uniform equipment identification, Caterpillar and other construction equipment manufacturers are moving to comply with the latest version of the product identification numbering standard. Non-road machine PINs are defined by ISO 10261. The new PIN format will apply to all Cat machines and generator sets. The PIN plates and frame marking will display the 17 character PIN. The new format will look like the following:



Illustration 1

g00751314

Where:

1. Caterpillar's World Manufacturing Code (characters 1-3)
2. Machine Descriptor (characters 4-8)
3. Check Character (character 9)
4. Machine Indicator Section (MIS) or Product Sequence Number (characters 10-17). These were previously referred to as the Serial Number.

<https://www.ebooklibonline.com>

Hello dear friend!

Thank you very much for reading.

Enter the link into your browser.

The full manual is available for immediate download.

<https://www.ebooklibonline.com>

Machines and generator sets produced before First Quarter 2001 will maintain their 8 character PIN format.

Components such as engines, transmissions, axles, etc. and work tools will continue to use an 8 character Serial Number (S/N).

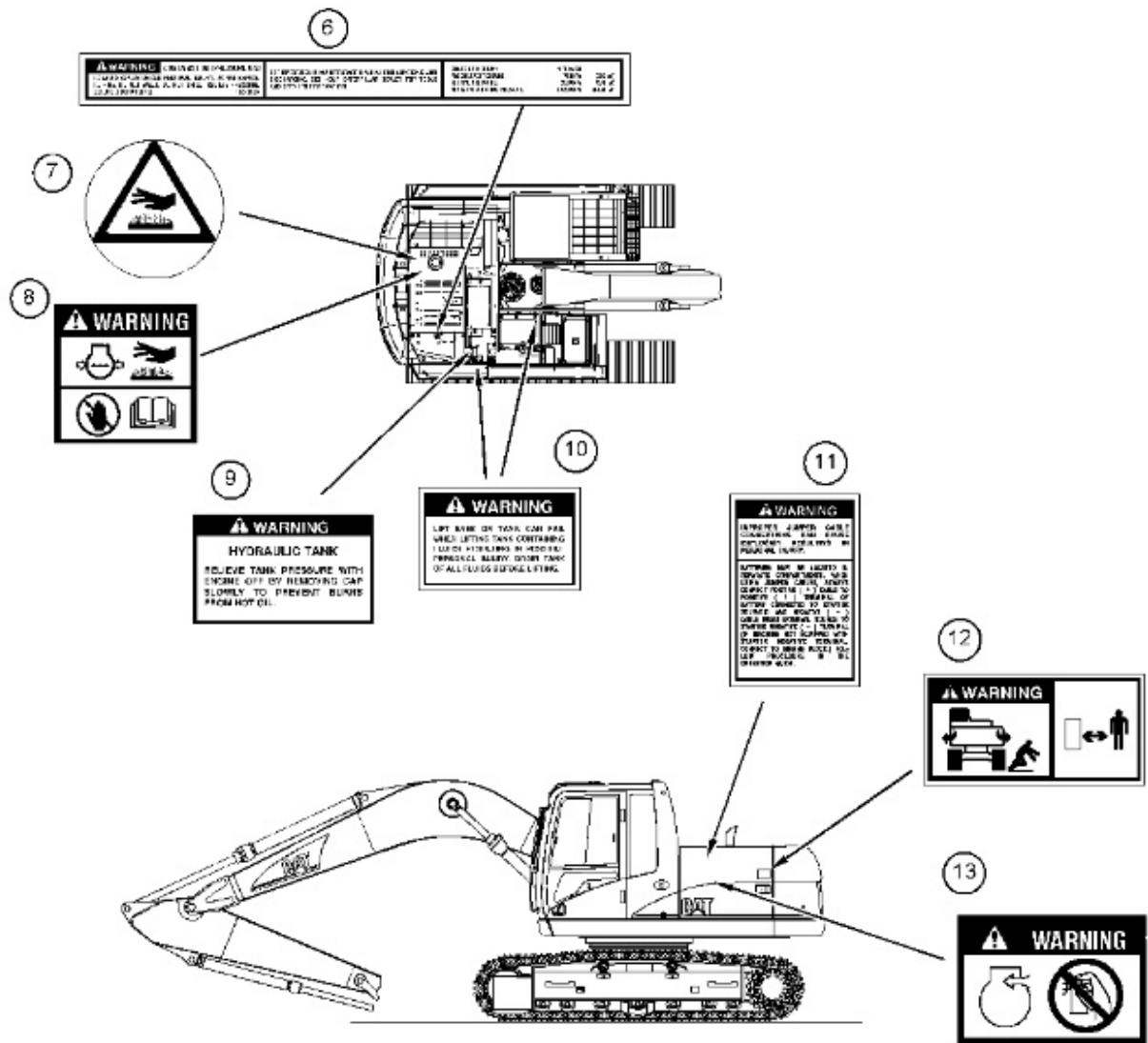

Illustration 3

g01114926

There are several specific safety messages on this machine. The exact location of the messages and the description of the messages are reviewed in this section. Please become familiarized with all safety messages.

Make sure that all of the safety messages are legible. Clean the safety messages or replace the safety messages if you cannot read the words. Replace the illustrations if the illustrations are not legible. When you clean the safety messages, use a cloth, water and soap. Do not use solvent, gasoline, or other harsh chemicals to clean the safety messages. Solvents, gasoline, or harsh chemicals could loosen the adhesive that secures the safety messages. Loose adhesive will allow the safety message to fall.

Replace any safety message that is damaged, or missing. If a safety message is attached to a part that is replaced, attach a safety message on the replacement part. Any Caterpillar dealer can provide new safety messages.

(1) Do Not Operate

This safety message is positioned inside the cab.

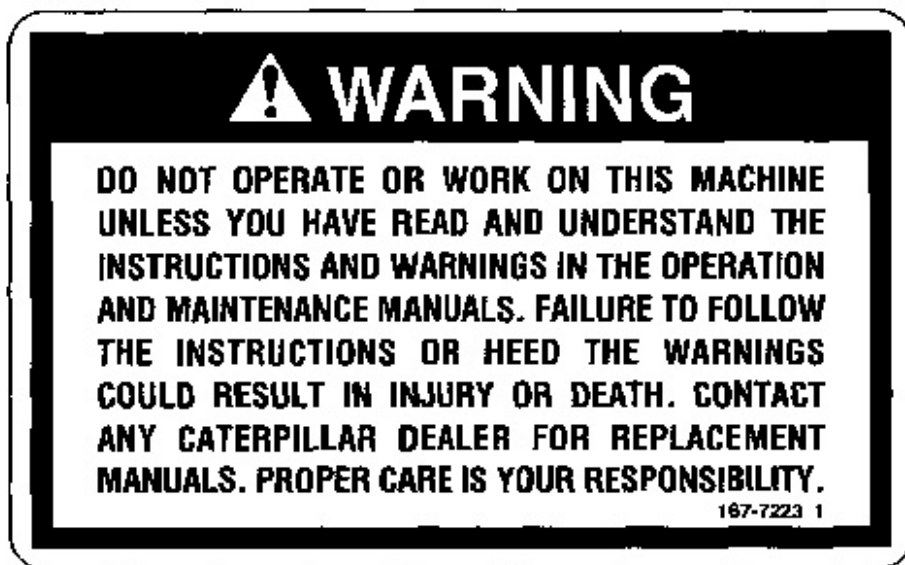

g00684449



Do not operate or work on this machine unless you have read and understand the instructions and warnings in the Operation and Maintenance Manuals. Failure to follow the instructions or heed the warnings could result in injury or death. Contact your Caterpillar dealer for replacement manuals. Proper care is your responsibility.

(2) Electrical Power Lines

This safety message is positioned in the cab.

 **WARNING**

**KNOW THE MAXIMUM HEIGHT AND REACH OF YOUR MACHINE
SERIOUS INJURY OR DEATH BY ELECTROCUTION
CAN OCCUR IF MACHINE OR ATTACHMENTS ARE
NOT KEPT A SAFE DISTANCE FROM ELECTRICAL
POWER LINES. KEEP DISTANCE AT LEAST 3 M (10
FEET) PLUS ADDITIONAL 10 MM (0.4 INCH) FOR
EACH 1,000 VOLTS OVER 50,000 VOLTS.**

7Y0003 2

g00100702

 **WARNING**

Know the maximum height and reach of your machine. Serious injury or death by electrocution can occur if machine, work tools, or attachments are not kept a safe distance from electrical power lines. Keep distance at least 3 m (10 ft) Plus additional 10 mm (.4 inch) for each 1,000 volts over 50,000 volts.

Refer to Operation and Maintenance Manual, "Specifications" for further information.

(3) Automatic Engine Speed Control (AEC)

This safety message is positioned in the cab.

 **WARNING**

AUTOMATIC ENGINE SPEED CONTROL (AEC) WILL INCREASE ENGINE SPEED AUTOMATICALLY WHEN YOU OPERATE THE CONTROL LEVER(S) AND/OR TRAVEL PEDALS WITH AEC SWITCH ON.

WHEN LOADING AND UNLOADING MACHINE FROM TRUCK OR WORKING IN CLOSE QUARTERS ALWAYS TURN OFF AEC SWITCH TO PREVENT ANY POSSIBILITY OF SUDDEN MOVEMENT OF MACHINE, WHICH COULD RESULT IN SERIOUS INJURY OR DEATH.

7Y0005 2

g00100749

 **WARNING**

AUTOMATIC ENGINE SPEED CONTROL (AEC) WILL INCREASE ENGINE SPEED AUTOMATICALLY WHEN YOU OPERATE THE CONTROL LEVER(S) AND/OR TRAVEL PEDALS WITH AEC SWITCH ON.

WHEN LOADING AND UNLOADING MACHINE FROM TRUCK OR WORKING IN CLOSE QUARTERS ALWAYS TURN OFF AEC SWITCH TO PREVENT ANY POSSIBILITY OF SUDDEN MOVEMENT OF MACHINE, WHICH COULD RESULT IN SERIOUS INJURY OR DEATH.

(4) Travel Speed Control Switch

This safety message is positioned in the cab.

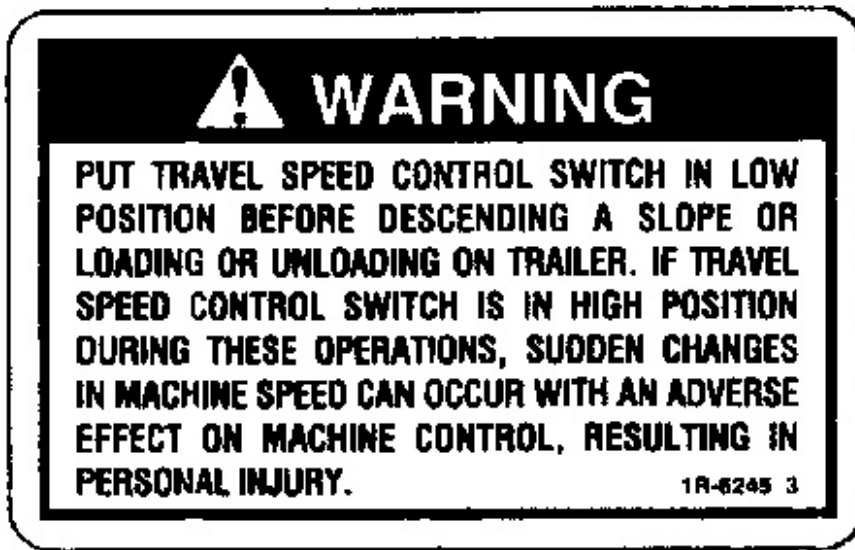

g00577852



Put travel speed control switch in **LOW** position before descending a slope or loading or unloading on trailer. If travel speed control switch is in **HIGH** position during these operations, sudden changes in machine speed can occur with an adverse effect on machine control, resulting in personal injury.

(5) Crushing Hazard

This safety message is positioned in the cab.





Personal injury can result if the window is not latched in the overhead position; ensure the auto lock is engaged.



(6) High Pressure Cylinder

This safety message is positioned on the hydraulic accumulator.



This system contains high pressure gas. Failure to follow the instructions and warnings could cause an explosion, resulting in possible injury or death.

Do not expose to fire. Do not weld. Do not drill. Relieve pressure before discharging.

See Operation and Maintenance Manual for charging and discharging. See your Caterpillar Dealer for tools and detailed information.



(7) Hot Surface

This safety message is positioned on the top surface of the radiator cap.





g00921005

 **WARNING**

Hot parts or hot components can cause burns or personal injury. Do not allow hot parts or components to contact your skin. Use protective clothing or protective equipment to protect your skin.

(8) Pressurized System

This safety message is located inside the engine compartment next to the cooling system filler cap.



g00977524

 **WARNING**

Pressurized system: Hot coolant can cause serious burn. To open cap, stop engine, wait until radiator is cool. Then loosen cap slowly to relieve the pressure.

Refer to Operation and Maintenance Manual, "Cooling System Coolant Level - Check" for further information.

(9) Relieve Hydraulic Tank Pressure

This safety message is located on top of the hydraulic tank.



g00100722

 **WARNING**

HYDRAULIC TANK

RELIEVE TANK PRESSURE WITH ENGINE OFF BY REMOVING CAP SLOWLY TO PREVENT BURNS FROM HOT OIL.

(10) Lift Eyes Can Fail

This safety message is located on the top of the hydraulic tank and on top of the fuel tank.

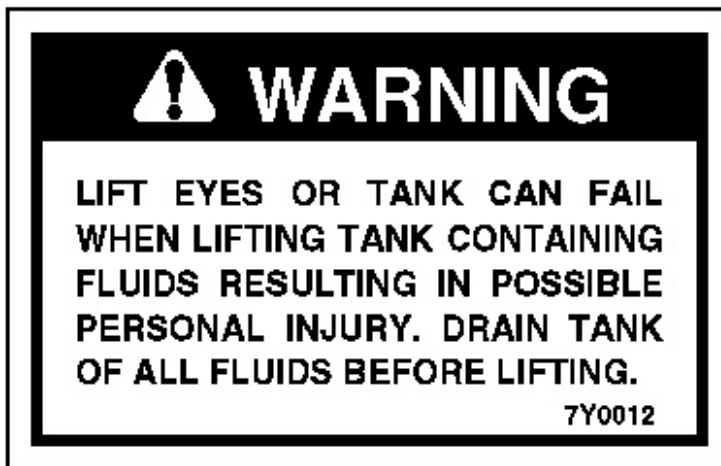

g00100728



LIFT EYES OR TANK CAN FAIL WHEN LIFTING TANK CONTAINING FLUIDS RESULTING IN POSSIBLE PERSONAL INJURY. DRAIN TANK OF ALL FLUIDS BEFORE LIFTING.

(11) Jump Start Cables

This safety message is positioned on the right side of the circuit breaker panel.

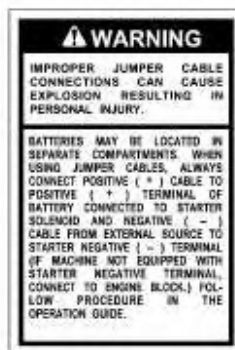

g01066454



Improper jumper cable connections may cause an explosion resulting in personal injury. Batteries may be located in separate compartments. When using jumper cables, always connect positive (+) cable to positive (+) terminal of battery connected to starter solenoid and negative (-) cable from external source to starter negative (-) terminal. (If not equipped with starter negative terminal, connect to engine block.) Follow procedure in the Operation and Maintenance Manual.

Refer to Operation and Maintenance Manual, "Engine Starting with Jump Start Cables" for further information.

(12) Crushing Hazard

This safety message is located on the left access door and the right access door of the machine.



g00750340

! WARNING

Machine swings. Stay back. Crushing hazard could cause serious injury or death.

(13) Aerosol Starting Aid

This safety message is positioned on the cover of the intake duct of the air cleaner.



g01103503



If equipped with an air inlet heater (AIH) for cold weather starting, do not use aerosol types of starting aids such as ether. Such use could result in an explosion and personal injury.

Refer to Operation and Maintenance Manual, "Engine Starting" for further information.

14 High Pressure Cylinder

This safety message is located on the track adjuster.

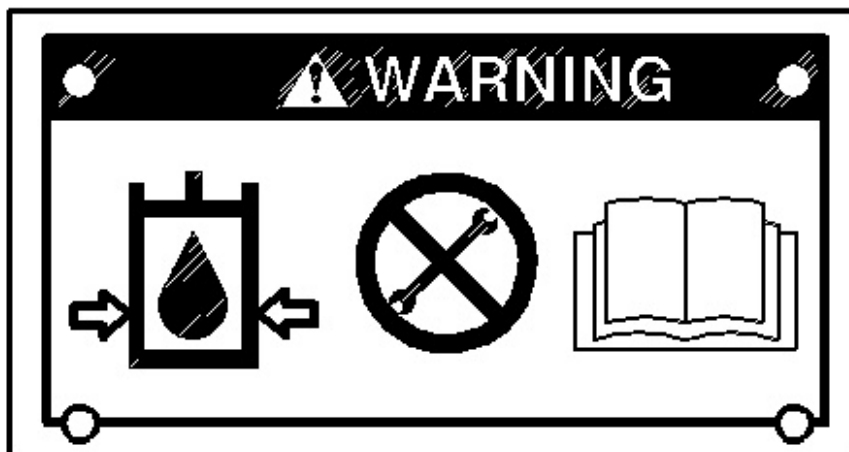

 **WARNING**

High Pressure Cylinder. Do not remove any parts from the cylinder until all of the pressure has been relieved. This will prevent possible personal injury or death.

Refer to Operation and Maintenance Manual, "Track Adjustment - Adjust" for the proper service procedure.

Product Link

This safety message is located in the cab.



 **WARNING**

This machine is equipped with a Caterpillar Product Link radio communication device which must be deactivated within 6.0 m (20 ft) of a blast zone. Failure to do so could result in serious injury or death.

Product: EXCAVATOR

Model: 312C EXCAVATOR FDS

Configuration: 312C & 312C L Excavators FDS00301-UP (MACHINE) POWERED BY 3064 Engine

Operation and Maintenance Manual 312C Excavator

Media Number -SEBU7424-06

Publication Date -01/04/2007

Date Updated -04/04/2007

i02242169

Safety Messages - Arrangement II

SMCS - 7000; 7405

There are several specific safety messages on this machine. The exact location of the hazards and the description of the hazards are reviewed in this section. Please become familiarized with all safety messages.

Make sure that all of the safety messages are legible. Clean the safety messages or replace the safety messages if you cannot read the words. Replace the illustrations if the illustrations are not visible. When you clean the safety messages, use a cloth, water and soap. Do not use solvent, gasoline, or other harsh chemicals to clean the safety messages. Solvents, gasoline, or harsh chemicals could loosen the adhesive that secures the safety message. Loose adhesive will allow the safety message to fall.

Replace any safety message that is damaged, or missing. If a safety message is attached to a part that is replaced, install a safety message on the replacement part. Any Caterpillar dealer can provide new safety messages.

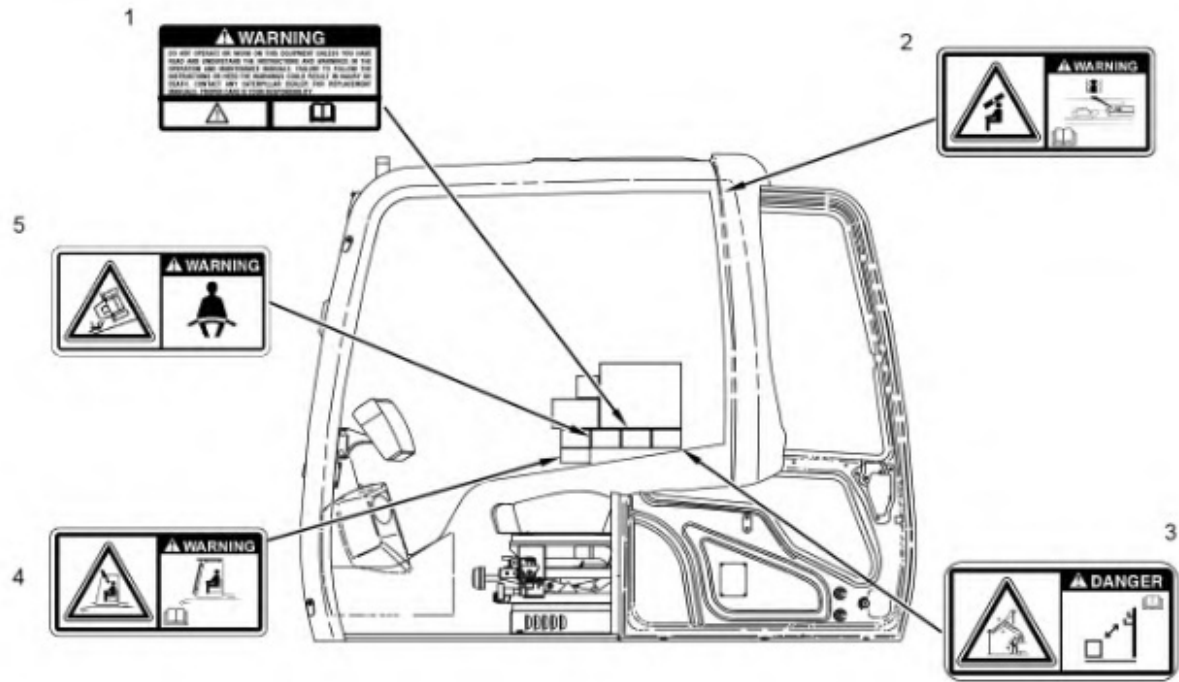

Illustration 1

g01130132

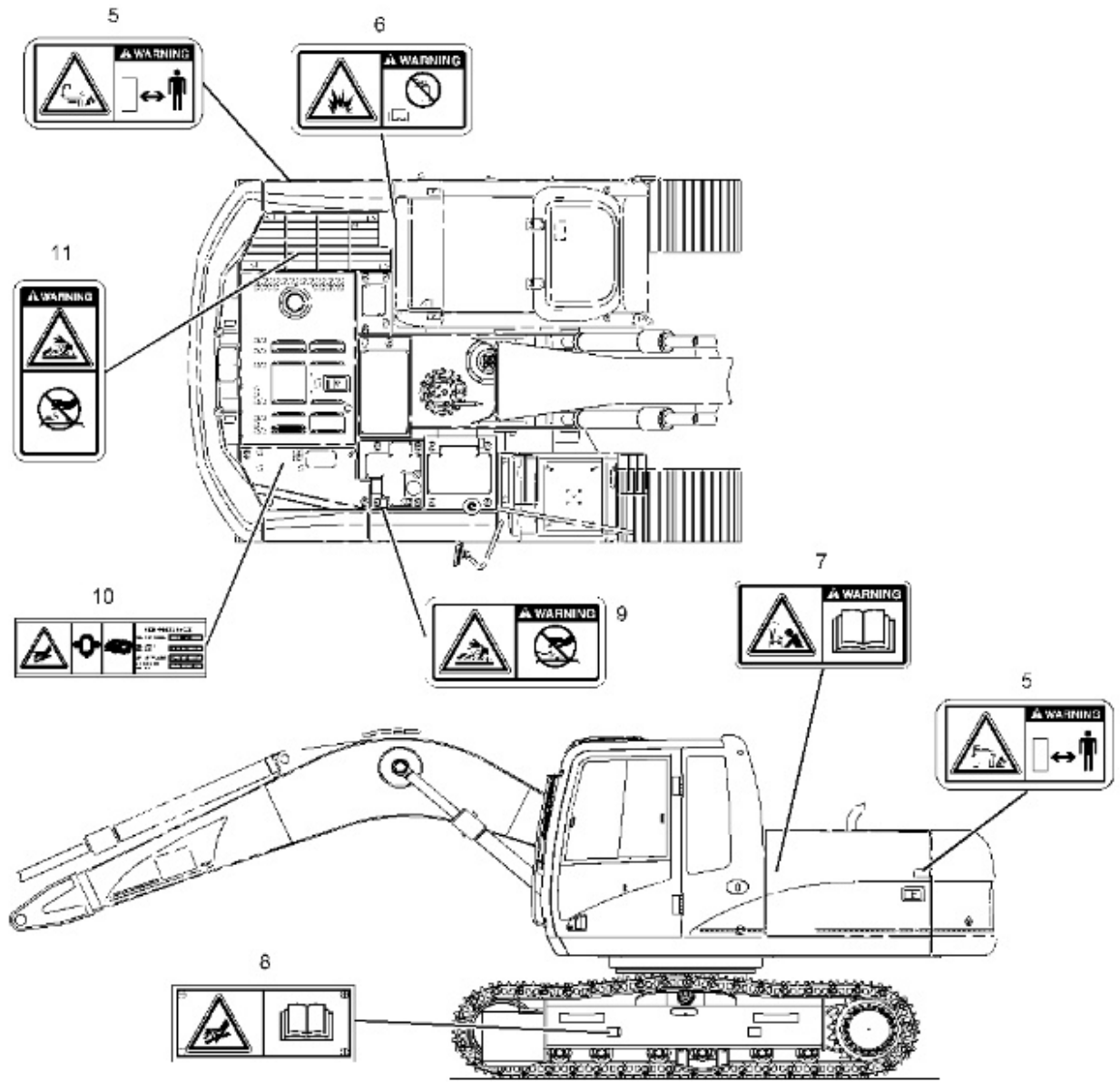

Illustration 2

g01120160

(1) Do Not Operate



Suggest:

For more complete manuals. Please go to the home page.

<https://www.ebooklibonline.com>

If the above button click is invalid. Please download this document first, and then click the above link to download the complete manual.

Thank you so much for reading



Illustration 3

g00930652

This safety message is located in the cab.



(2) Crushing hazard



Illustration 4

g01067551

This safety message is located in the cab.

! WARNING

Personal injury can result if the window is not latched in the overhead position; ensure the auto lock is engaged.

(3) Seat Belt



Illustration 5

g01067563

This safety message is located in the cab.

! WARNING

A seat belt should be worn at all times during machine operation to prevent serious injury or death in the event of an accident or machine overturn. Failure to wear a seat belt during machine operation may result in serious injury or death.

(4) Crushing Hazard

<https://www.ebooklibonline.com>

Hello dear friend!

Thank you very much for reading.

Enter the link into your browser.

The full manual is available for immediate download.

<https://www.ebooklibonline.com>