

OMAR309174 - 9230, 9330, 9430,9530 and 9630Tractors

Recognize Safety Information

Recognize Safety Information

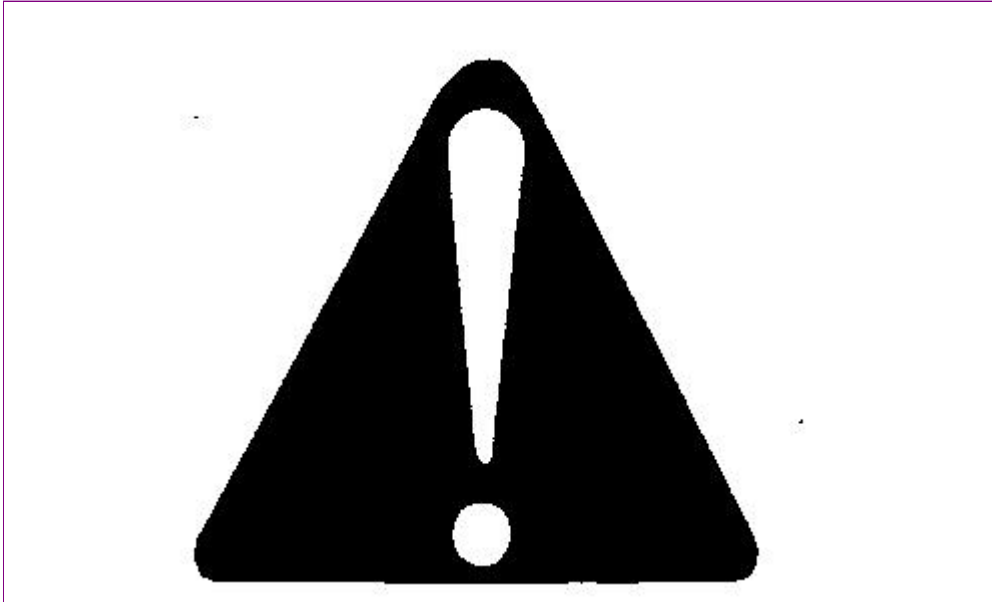

T81389-UN: Safety-alert symbol

This is a safety-alert symbol. When you see this symbol on your machine or in this manual, be alert to the potential for personal injury.

Follow recommended precautions and safe operating practices.

OMAR309174 - 9230, 9330, 9430,9530 and 9630Tractors

Understand Signal Words

Understand Signal Words



TS187-19: Signal Words

A signal word—DANGER, WARNING, or CAUTION—is used with the safety-alert symbol. DANGER identifies the most serious hazards.

DANGER or WARNING safety signs are located near specific hazards. General precautions are listed on CAUTION safety signs. CAUTION also calls attention to safety messages in this manual.

OMAR309174 - 9230, 9330, 9430,9530 and 9630Tractors Follow Safety Instructions

Follow Safety Instructions

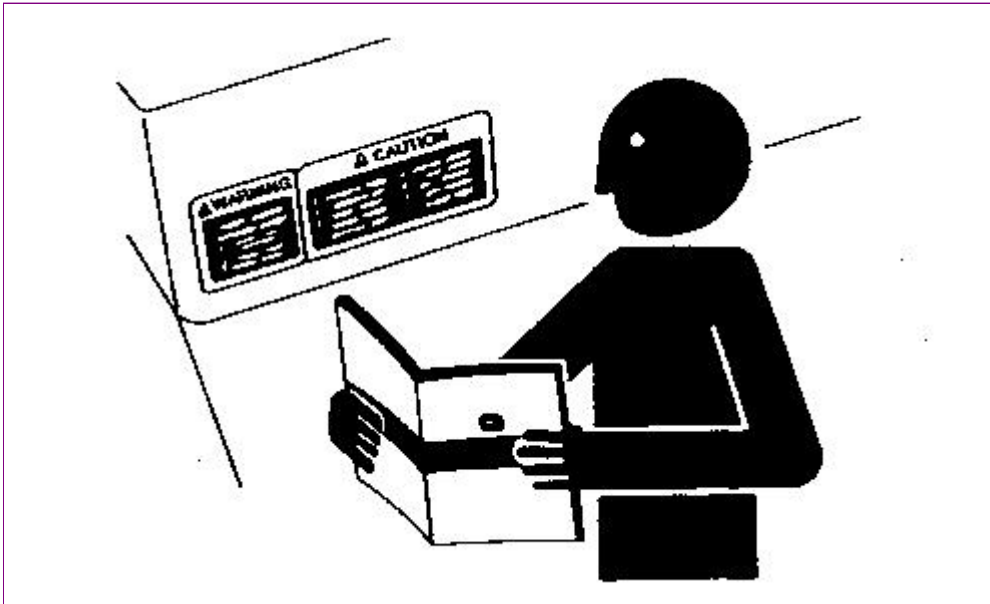

TS201-UN: Safety Messages

Carefully read all safety messages in this manual and on your machine safety signs. Keep safety signs in good condition. Replace missing or damaged safety signs. Be sure new equipment components and repair parts include the current safety signs. Replacement safety signs are available from your John Deere dealer.

Learn how to operate the machine and how to use controls properly. Do not let anyone operate without instruction.

Keep your machine in proper working condition. Unauthorized modifications to the machine may impair the function and/or safety and affect machine life.

If you do not understand any part of this manual and need assistance, contact your John Deere dealer.

<https://www.ebooklibonline.com>

Hello dear friend!

Thank you very much for reading.

Enter the link into your browser.

The full manual is available for immediate download.

<https://www.ebooklibonline.com>

OMAR309174 - 9230, 9330, 9430,9530 and 9630Tractors Prepare for Emergencies

Prepare for Emergencies

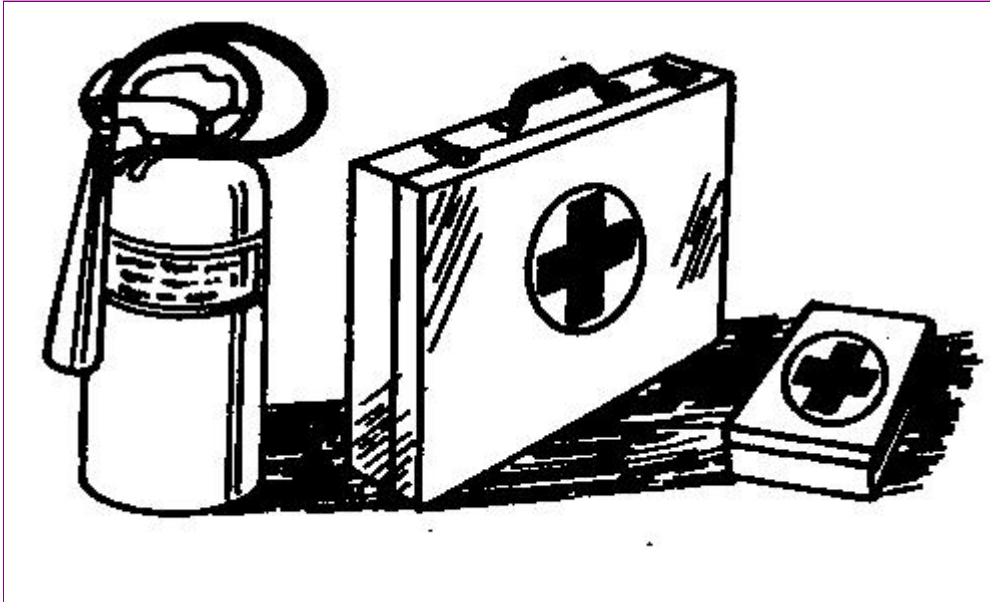

TS291-UN: First Aid Kit

Be prepared if a fire starts.

Keep a first aid kit and fire extinguisher handy.

Keep emergency numbers for doctors, ambulance service, hospital, and fire department near your telephone.

OMAR309174 - 9230, 9330, 9430,9530 and 9630Tractors
Wear Protective Clothing

Wear Protective Clothing

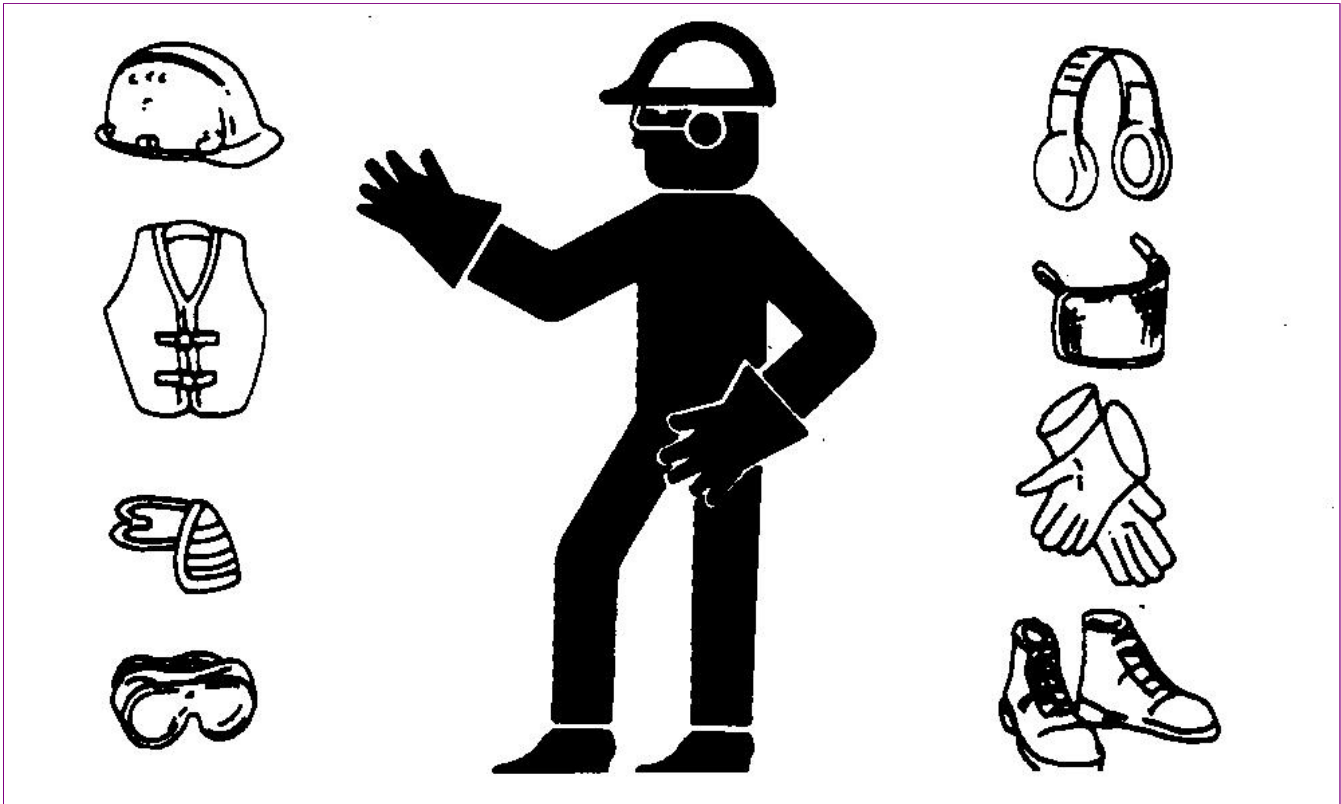

TS206-UN: Protective Clothing

Wear close fitting clothing and safety equipment appropriate to the job.

Operating equipment safely requires the full attention of the operator. Do not wear radio or music headphones while operating machine.

OMAR309174 - 9230, 9330, 9430,9530 and 9630Tractors Protect Against Noise

Protect Against Noise



TS207-UN: Noise Exposure

Prolonged exposure to loud noise can cause impairment or loss of hearing.

Wear a suitable hearing protective device such as earmuffs or earplugs to protect against objectionable or uncomfortable loud noises.

OMAR309174 - 9230, 9330, 9430,9530 and 9630 Tractors Handle Fuel Safely—Avoid Fires

Handle Fuel Safely—Avoid Fires



TS202-UN: Avoid Fires

Handle fuel with care: it is highly flammable. Do not refuel the machine while smoking or when near open flame or sparks.

Always stop engine before refueling machine. Fill fuel tank outdoors.

Prevent fires by keeping machine clean of accumulated trash, grease, and debris. Always clean up spilled fuel.

OMAR309174 - 9230, 9330, 9430,9530 and 9630 Tractors Handle Starting Fluid Safely

Handle Starting Fluid Safely



TS1356-UN: Store Safely

Starting fluid is highly flammable.

Keep all sparks and flame away when using it. Keep starting fluid away from batteries and cables.

To prevent accidental discharge when storing the pressurized can, keep the cap on the container, and store in a cool, protected location.

Do not incinerate or puncture a starting fluid container.

OMAR309174 - 9230, 9330, 9430,9530 and 9630Tractors Keep ROPS Installed Properly

Keep ROPS Installed Properly

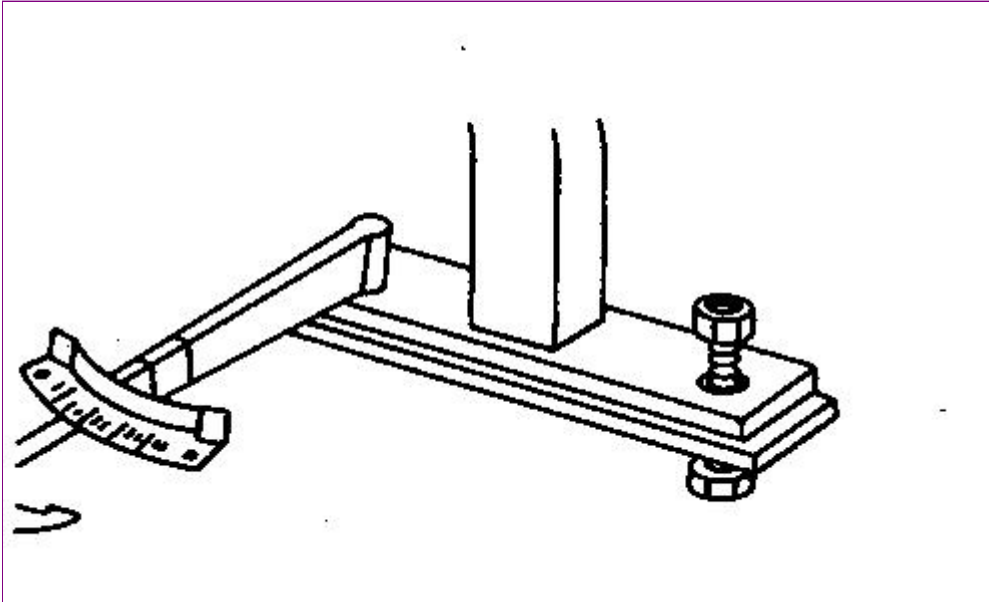

TS212-UN: Roll-Over Protective Structure

Make certain all parts are reinstalled correctly if the roll-over protective structure (ROPS) is loosened or removed for any reason. Tighten mounting bolts to proper torque.

The protection offered by ROPS will be impaired if ROPS is subjected to structural damage, is involved in an overturn incident, or is in any way altered by welding, bending, drilling, or cutting. A damaged ROPS should be replaced, not reused.



Suggest:

For more complete manuals. Please go to the home page.

<https://www.ebooklibonline.com>

If the above button click is invalid. Please download this document first, and then click the above link to download the complete manual.

Thank you so much for reading

OMAR309174 - 9230, 9330, 9430,9530 and 9630 Tractors Stay Clear of Rotating Drivelines

Stay Clear of Rotating Drivelines



TS1644-UN: Rotating Drivelines

Entanglement in rotating driveline can cause serious injury or death.

Keep tractor master shield and driveline shields in place at all times. Make sure rotating shields turn freely.

Wear close fitting clothing. Stop the engine and be sure PTO driveline is stopped before making adjustments, connections, or cleaning out PTO driven equipment.

OMAR309174 - 9230, 9330, 9430,9530 and 9630Tractors Use Seat Belt Properly

Use Seat Belt Properly

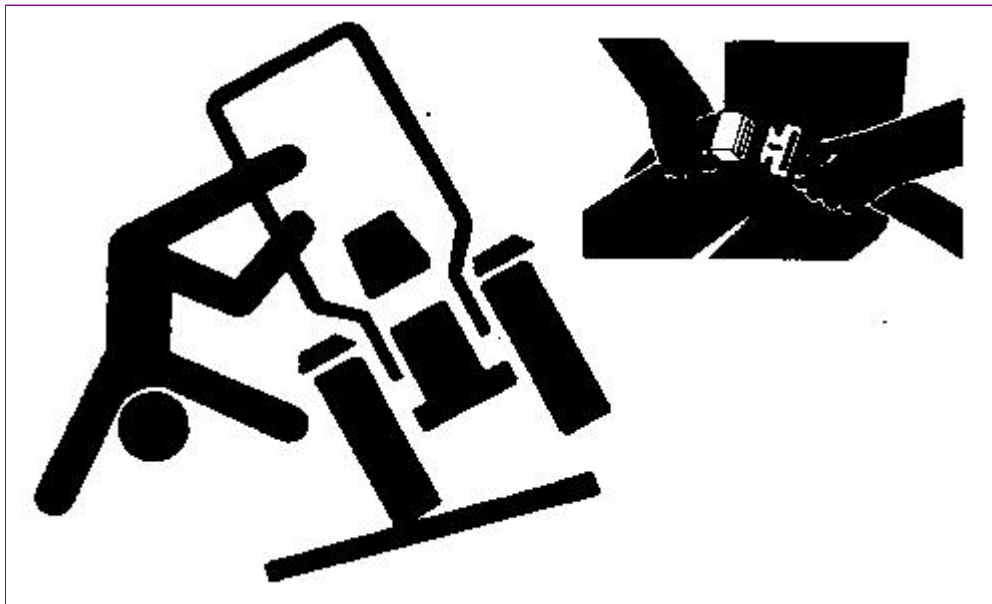

TS205-UN: Use a Seat Belt

Use a seat belt when you operate with a roll-over protective structure (ROPS) or cab to minimize chance of injury from an accident such as an overturn.

Do not use a seat belt if operating without a ROPS or cab.

Replace entire seat belt if mounting hardware, buckle, belt, or retractor show signs of damage.

Inspect seat belt and mounting hardware at least once a year. Look for signs of loose hardware or belt damage, such as cuts, fraying, extreme or unusual wear, discoloration, or abrasion. Replace only with replacement parts approved for your machine. See your John Deere dealer.

<https://www.ebooklibonline.com>

Hello dear friend!

Thank you very much for reading.

Enter the link into your browser.

The full manual is available for immediate download.

<https://www.ebooklibonline.com>