

omar113290 - 7200 and 7400 Tractors Recognize Safety Information

Recognize Safety Information

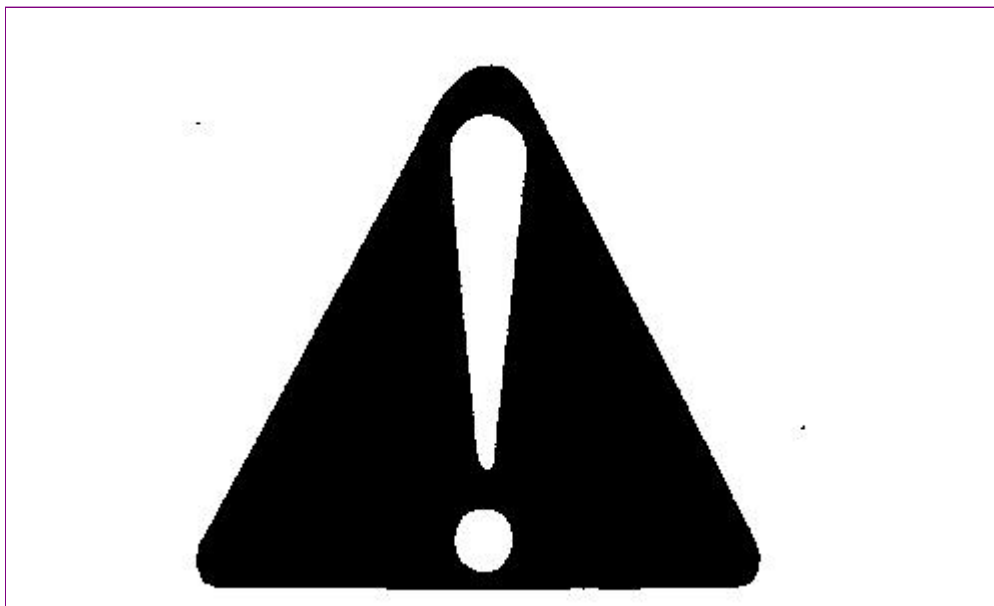

T81389-UN: Safety-Alert Symbol

This is a safety-alert symbol. When you see this symbol on your machine or in this manual, be alert to the potential for personal injury.

Follow recommended precautions and safe operating practices.

omar113290 - 7200 and 7400 Tractors Understand Signal Words

Understand Signal Words



TS187-19: Signal Words

A signal word-DANGER, WARNING, or CAUTION-is used with the safety-alert symbol. DANGER identifies the most serious hazards.

DANGER or WARNING safety signs are located near specific hazards. General precautions are listed on CAUTION safety signs. CAUTION also calls attention to safety messages in this manual.

omar113290 - 7200 and 7400 Tractors Follow Safety Instructions

Follow Safety Instructions

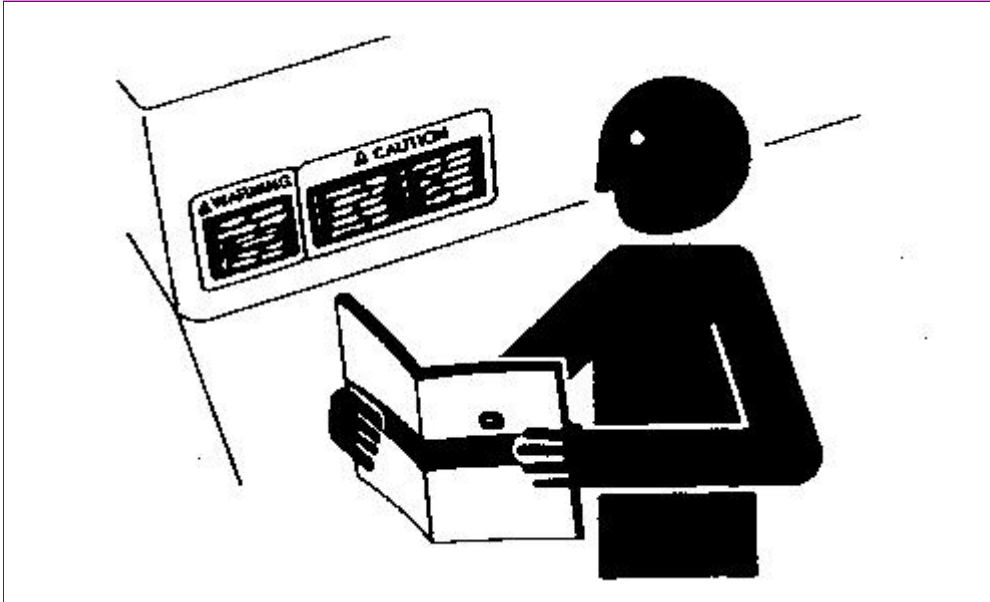

TS201-UN: Safety Messages

Carefully read all safety messages in this manual and on your machine safety signs. Keep safety signs in good condition. Replace missing or damaged safety signs. Be sure new equipment components and repair parts include the current safety signs. Replacement safety signs are available from your John Deere dealer.

Learn how to operate the machine and how to use controls properly. Do not let anyone operate without instruction.

Keep your machine in proper working condition. Unauthorized modifications to the machine may impair the function and/or safety and affect machine life.

If you do not understand any part of this manual and need assistance, contact your John Deere dealer.

<https://www.ebooklibonline.com>

Hello dear friend!

Thank you very much for reading.

Enter the link into your browser.

The full manual is available for immediate download.

<https://www.ebooklibonline.com>

omar113290 - 7200 and 7400 Tractors Operating the Tractor Safely

Operating the Tractor Safely



TS213-UN: Operate Tractor Safely



TS276-UN: Avoid Accidents

Careless use of the tractor can result in unnecessary accidents. Be alert to hazards of tractor operation. Understand causes of accidents and take every precaution to avoid them. Most common accidents are caused from:

- Tractor roll-over
- Improper starting procedures
- Crushing and pinching during hitching
- Collisions with other motor vehicles
- Entanglement in PTO shafts

- Falling from tractor

Avoid accidents by taking the following precautions:

Put transmission in PARK before dismounting. Leaving transmission in gear with engine stopped will NOT prevent the tractor from moving.

Be sure everyone is clear of tractor and attached equipment before starting engine.

Never try to get on or off a moving tractor.

When tractor is left unattended, place in PARK, lower implements to the ground, stop the engine, and remove the key.

Never go near an operating PTO or an operating implement.

Always fasten your seat belt in a ROPS equipped tractor.

omar113290 - 7200 and 7400 Tractors Prevent Machine Runaway

Prevent Machine Runaway

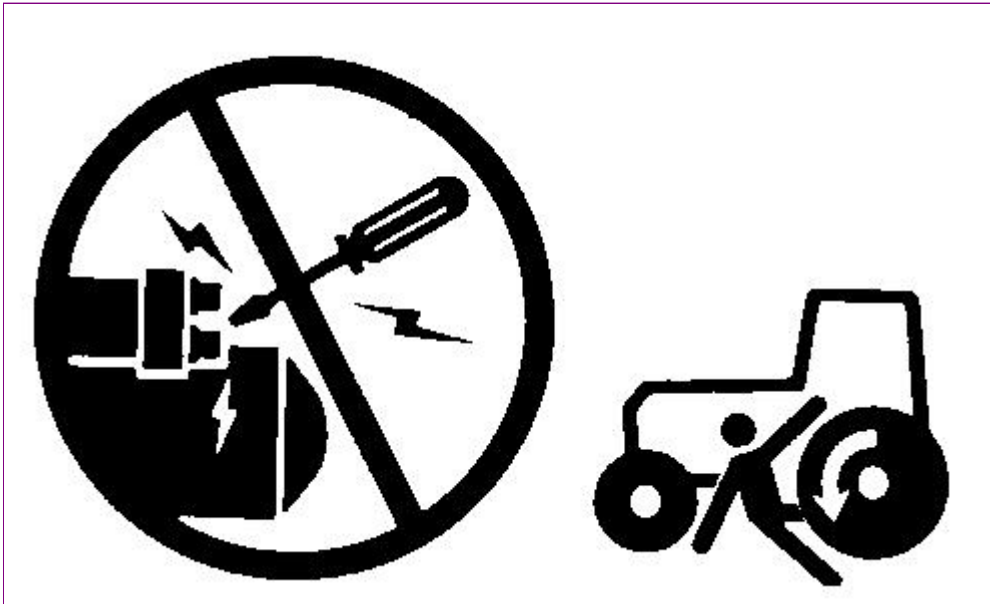

TS177-UN: Machinery Runaway

Avoid possible injury or death from machinery runaway.

Do not start engine by shorting across starter terminals. Machine will start in gear if normal circuitry is bypassed.

NEVER start engine while standing on ground. Start engine only from operator's seat, with transmission in neutral or park.

omar113290 - 7200 and 7400 Tractors Stopping and Parking Tractor

Stopping and Parking Tractor

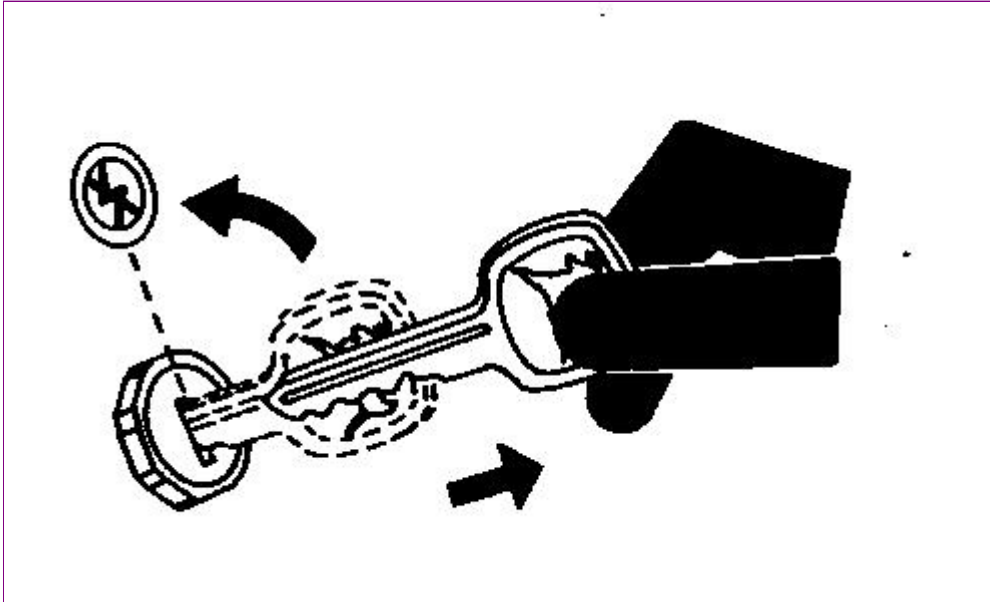

TS230-UN: Starting Tractor

Tractor roll-over, collisions, runaway tractors, and people being crushed under machines and implements can happen when operators ignore safety.

To avoid these accidents, take some precautions:

- Signal before stopping, turning, or slowing down on public roads
- Pull over to side of road before stopping
- Slow down before braking
- Pump brakes when stopping on slippery surfaces
- Be careful when towing and stopping heavy loads
- Shift to park or apply parking brake
- Lower all equipment when leaving tractor
- Remove key

omar113290 - 7200 and 7400 Tractors Use ROPS and Seat Belt Properly

Use ROPS and Seat Belt Properly

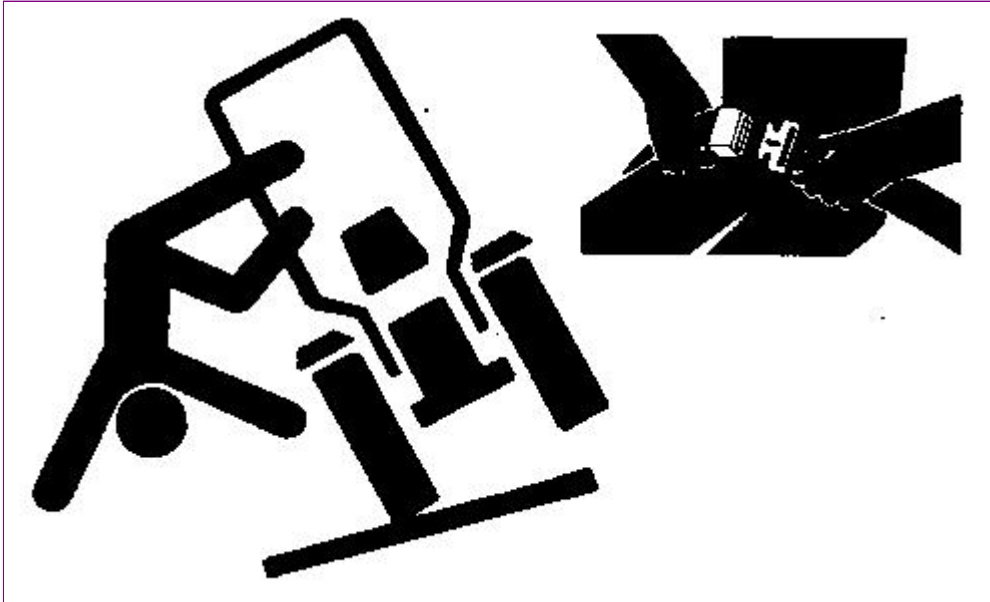

TS205-UN: Fasten Your Seat Belt

If this tractor is equipped with a foldable ROPS, keep the ROPS in the fully extended and locked position. If the tractor is ever operated with ROPS folded (e.g., to enter a low building), drive with extreme caution. Do NOT use seat belt with the ROPS folded.

Return the ROPS to the raised, fully extended and locked position as soon as the tractor is operated under normal conditions. Always fasten your seat belt when the ROPS is fully extended and locked.

omar113290 - 7200 and 7400 Tractors Keep ROPS Installed Properly

Keep ROPS Installed Properly

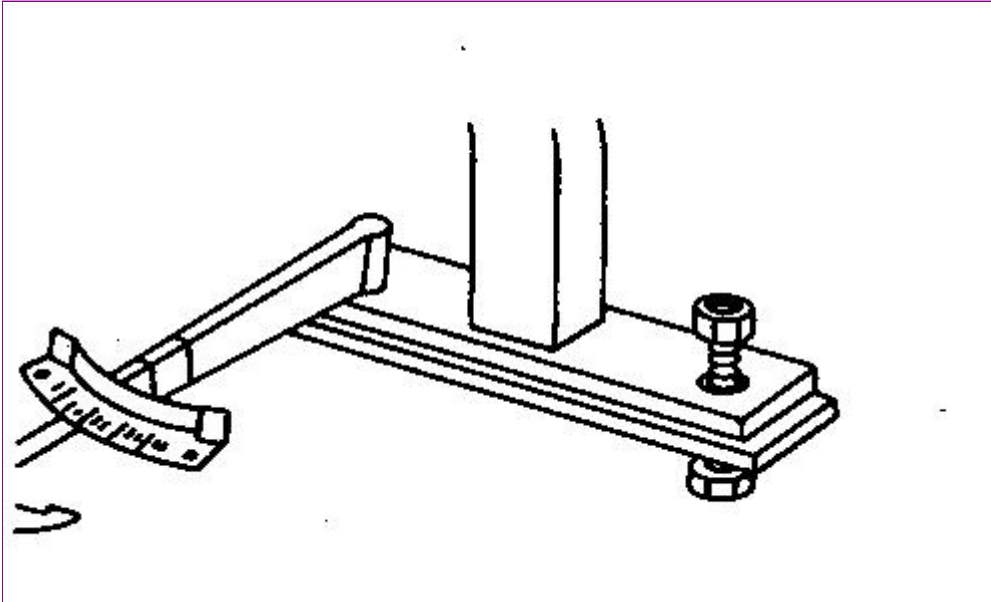

TS212-UN: Roll-Over Protective Structure

Make certain all parts are reinstalled correctly if the roll-over protective structure (ROPS) is loosened or removed for any reason. Tighten mounting bolts to proper torque.

The protection offered by ROPS will be impaired if ROPS is subjected to structural damage, is involved in an overturn incident, or is in any way altered by welding, bending, drilling, or cutting. A damaged ROPS should be replaced, not reused.



Suggest:

For more complete manuals. Please go to the home page.

<https://www.ebooklibonline.com>

If the above button click is invalid. Please download this document first, and then click the above link to download the complete manual.

Thank you so much for reading

omar113290 - 7200 and 7400 Tractors Use Caution on Hillsides

Use Caution on Hillsides

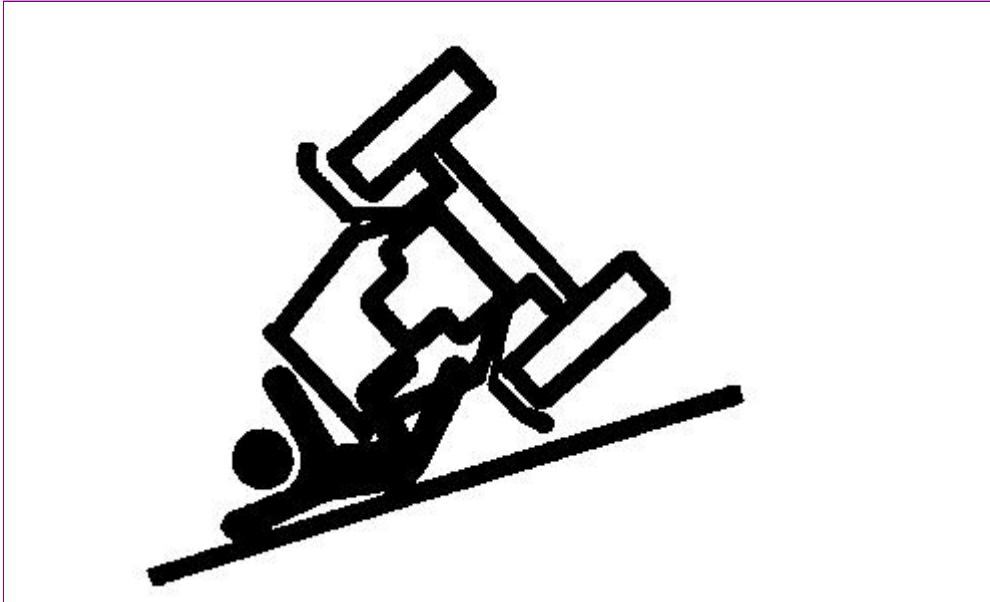

RW13093-UN: Use Caution on Hillsides

Avoid holes, ditches, and obstructions which may cause tractor roll-over, especially on hillsides. Avoid sharp turns on hills.

Never drive near the edge of a gully or steep embankment.

Driving out of a ditch, mired condition, or up a steep slope could cause tractor to tip over rearward. Back out of these situations if possible.

omar113290 - 7200 and 7400 Tractors Keep Riders Off Machine

Keep Riders Off Machine

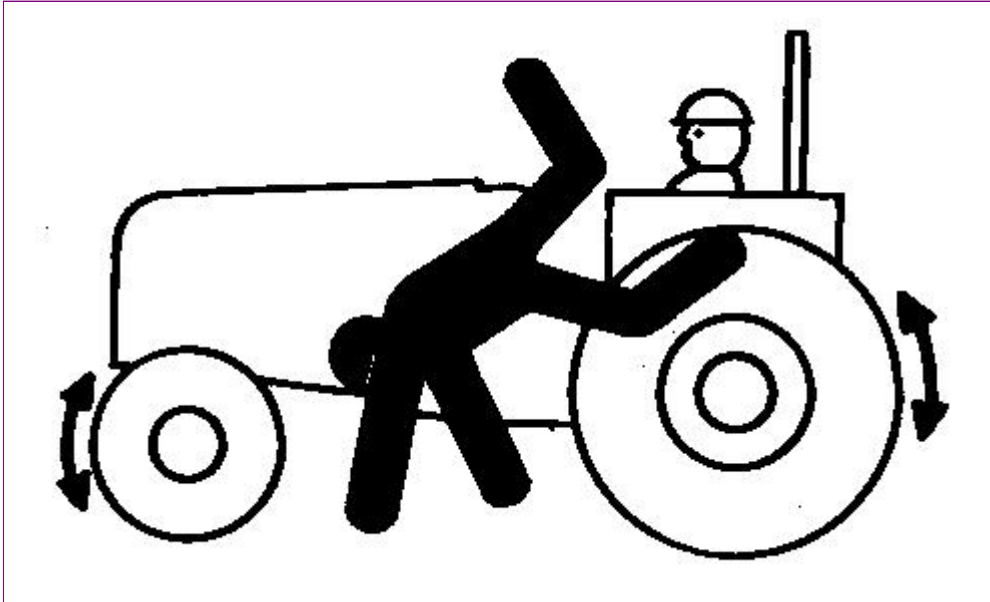

TS290-UN: Keep Riders Off

Only allow the operator on the machine. Keep riders off.

Riders on machine are subject to injury such as being struck by foreign objects and being thrown off of the machine. Riders also obstruct the operator's view resulting in the machine being operated in an unsafe manner.

<https://www.ebooklibonline.com>

Hello dear friend!

Thank you very much for reading.

Enter the link into your browser.

The full manual is available for immediate download.

<https://www.ebooklibonline.com>