

OMSU21580 - 5425, 5425 Orchard, 5425HC,5625, 5625HC,5725, 5725 Orchard,and 5725HC Tractors, Operator's Manual (Export Edition, September 2012)
Recognize Safety Information

Recognize Safety Information

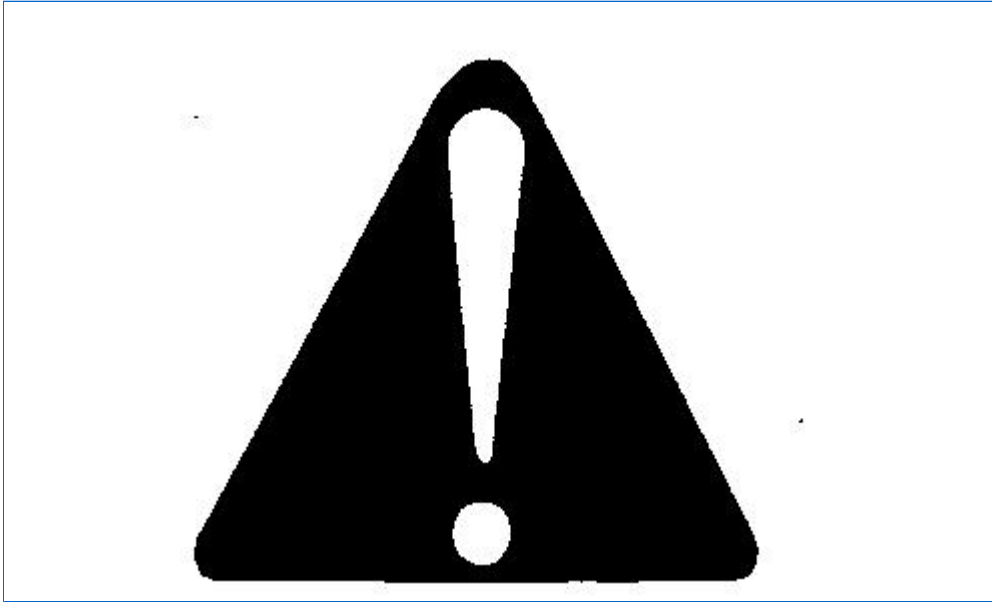

T81389-UN: Safety-alert symbol

This is a safety-alert symbol. When you see this symbol on your machine or in this manual, be alert to the potential for personal injury.

Follow recommended precautions and safe operating practices.

OMSU21580 - 5425, 5425 Orchard, 5425HC,5625, 5625HC,5725, 5725 Orchard,and 5725HC Tractors, Operator's Manual (Export Edition, September 2012)
Understand Signal Words

Understand Signal Words



TS187-19: Signal Words

A signal word—DANGER, WARNING, or CAUTION—is used with the safety-alert symbol. DANGER identifies the most serious hazards.

DANGER or WARNING safety signs are located near specific hazards. General precautions are listed on CAUTION safety signs. CAUTION also calls attention to safety messages in this manual.

**OMSU21580 - 5425, 5425 Orchard, 5425HC,5625, 5625HC,5725, 5725 Orchard,and 5725HC Tractors, Operator's Manual (Export Edition, September 2012)
Follow Safety Instructions**

Follow Safety Instructions

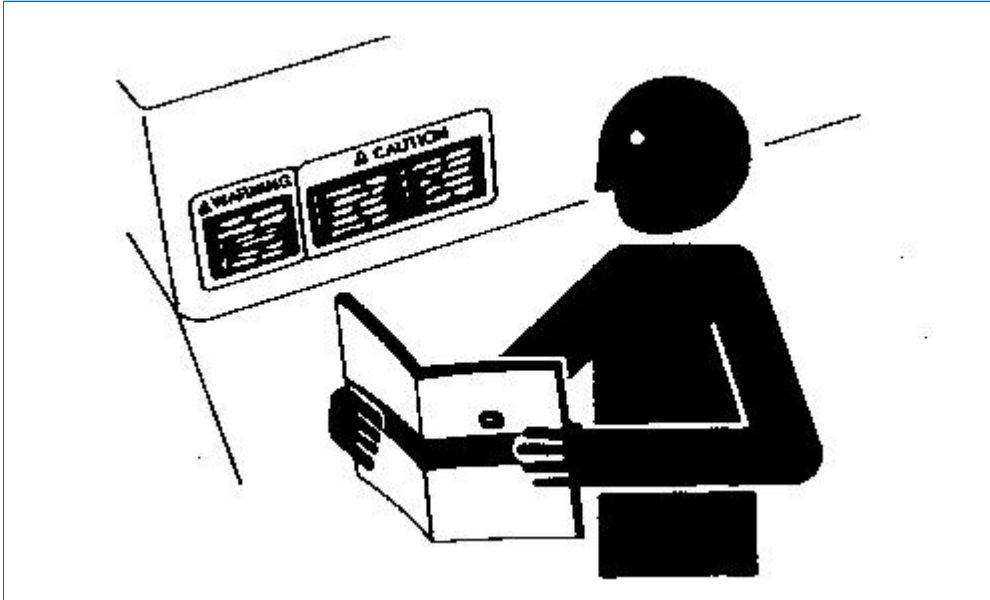

TS201-UN: Safety Messages

Carefully read all safety messages in this manual and on your machine safety signs. Keep safety signs in good condition. Replace missing or damaged safety signs. Be sure new equipment components and repair parts include the current safety signs. Replacement safety signs are available from your John Deere dealer.

There can be additional safety information contained on parts and components sourced from suppliers that is not reproduced in this operator's manual.

Learn how to operate the machine and how to use controls properly. Do not let anyone operate without instruction.

Keep your machine in proper working condition. Unauthorized modifications to the machine may impair the function and/or safety and affect machine life.

If you do not understand any part of this manual and need assistance, contact your John Deere dealer.

<https://www.ebooklibonline.com>

Hello dear friend!

Thank you very much for reading.

Enter the link into your browser.

The full manual is available for immediate download.

<https://www.ebooklibonline.com>

OMSU21580 - 5425, 5425 Orchard, 5425HC,5625, 5625HC,5725, 5725 Orchard,and 5725HC Tractors, Operator's Manual (Export Edition, September 2012)
Prepare for Emergencies

Prepare for Emergencies

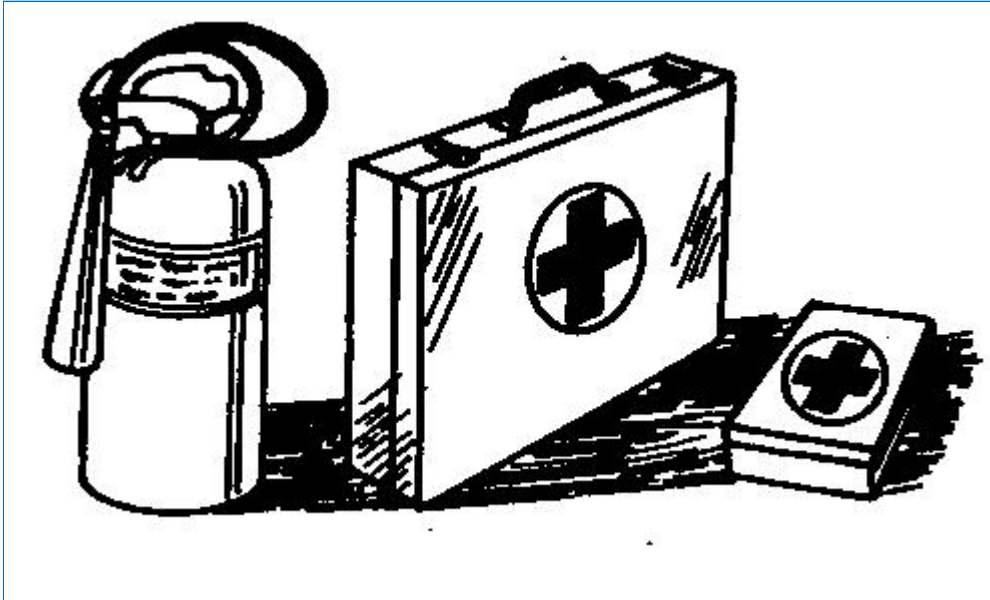

TS291-UN: First Aid Kit

Be prepared if a fire starts.

Keep a first aid kit and fire extinguisher handy.

Keep emergency numbers for doctors, ambulance service, hospital, and fire department near your telephone.

Wear Protective Clothing

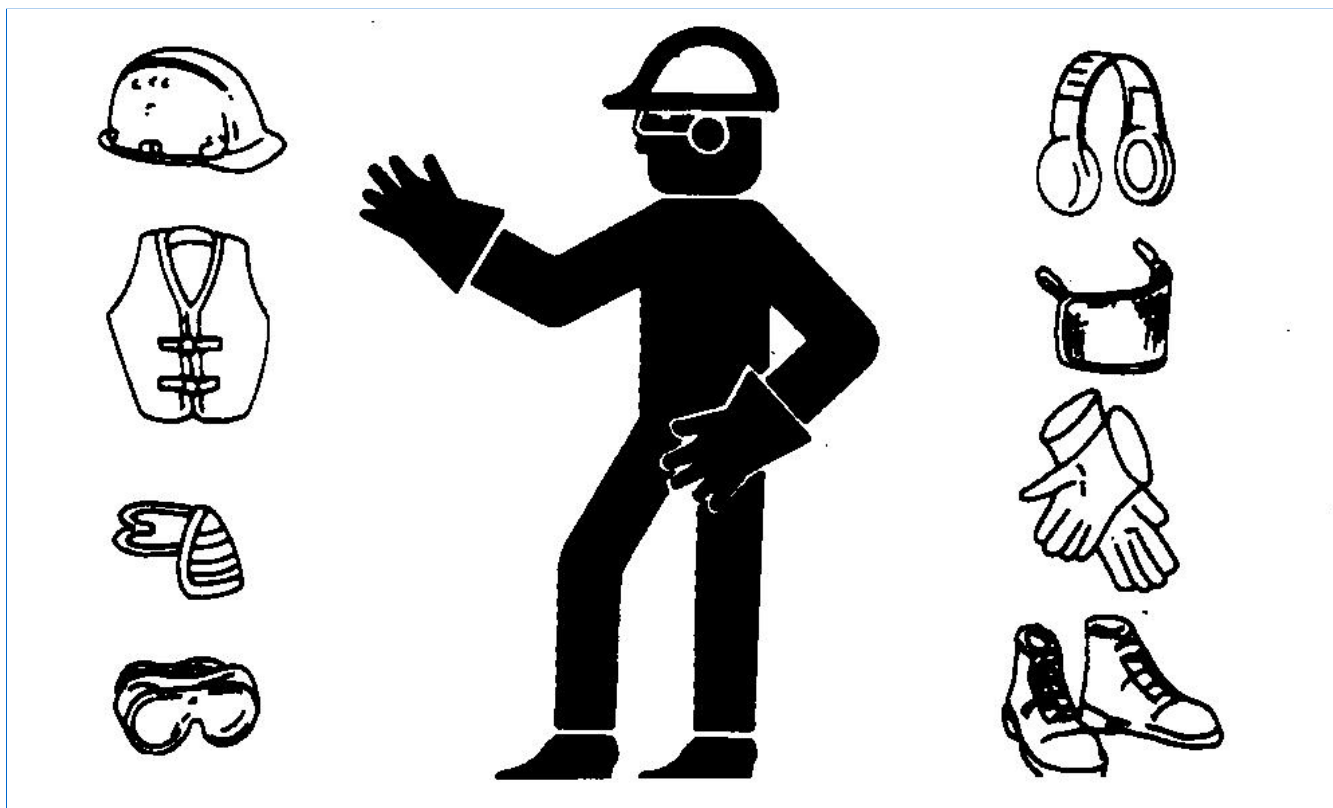

TS206-UN: Protective Clothing

Wear close fitting clothing and safety equipment appropriate to the job.

Operating equipment safely requires the full attention of the operator. Do not wear radio or music headphones while operating machine.

**OMSU21580 - 5425, 5425 Orchard, 5425HC,5625, 5625HC,5725, 5725 Orchard,and 5725HC Tractors, Operator's Manual (Export Edition, September 2012)
Protect Against Noise**

Protect Against Noise

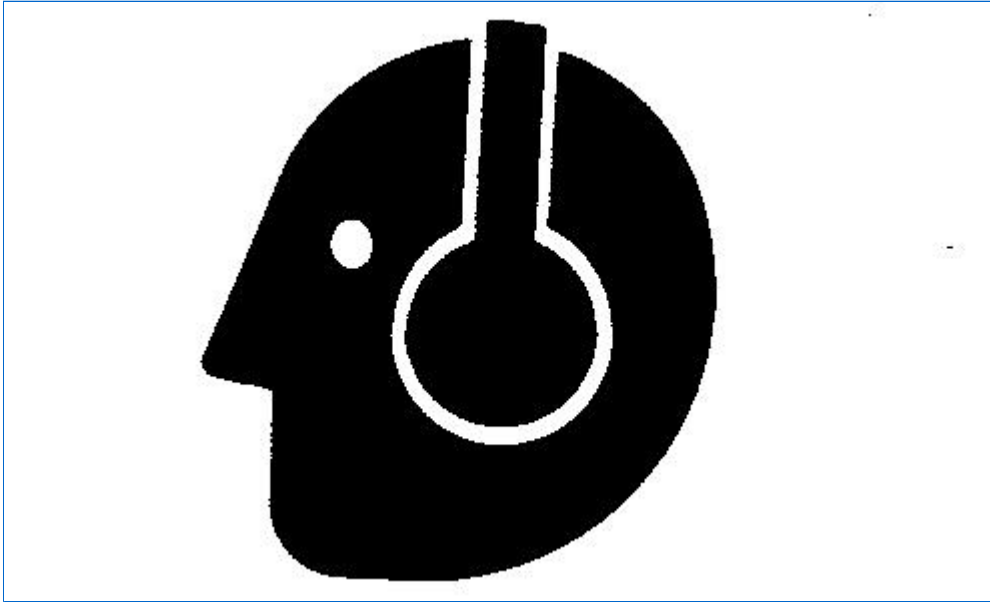

TS207-UN: Noise Exposure

Prolonged exposure to loud noise can cause impairment or loss of hearing.

Wear a suitable hearing protective device such as earmuffs or earplugs to protect against objectionable or uncomfortable loud noises.

**OMSU21580 - 5425, 5425 Orchard, 5425HC,5625, 5625HC,5725, 5725 Orchard,and 5725HC Tractors, Operator's Manual (Export Edition, September 2012)
Handle Fuel Safely—Avoid Fires**

Handle Fuel Safely—Avoid Fires



TS202-UN: Avoid Fires

Handle fuel with care: it is highly flammable. Do not refuel the machine while smoking or when near open flame or sparks.

Always stop engine before refueling machine. Fill fuel tank outdoors.

Prevent fires by keeping machine clean of accumulated trash, grease, and debris. Always clean up spilled fuel.

Use only an approved fuel container for transporting flammable liquids.

Never fill fuel container in pickup truck with plastic bed liner. Always place fuel container on ground before refueling. Touch fuel container with fuel dispenser nozzle before removing can lid. Keep fuel dispenser nozzle in contact with fuel container inlet when filling.

Do not store fuel container where there is an open flame, spark, or pilot light such as within a water heater or other appliance.

OMSU21580 - 5425, 5425 Orchard, 5425HC,5625, 5625HC,5725, 5725 Orchard,and 5725HC Tractors, Operator's Manual (Export Edition, September 2012)
Handle Starting Fluid Safely

Handle Starting Fluid Safely



TS1356-UN: Store Safely

Starting fluid is highly flammable.

Keep all sparks and flame away when using it. Keep starting fluid away from batteries and cables.

To prevent accidental discharge when storing the pressurized can, keep the cap on the container, and store in a cool, protected location.

Do not incinerate or puncture a starting fluid container.

OMSU21580 - 5425, 5425 Orchard, 5425HC,5625, 5625HC,5725, 5725 Orchard,and 5725HC Tractors, Operator's Manual (Export Edition, September 2012)
Keep ROPS Installed Properly

Keep ROPS Installed Properly

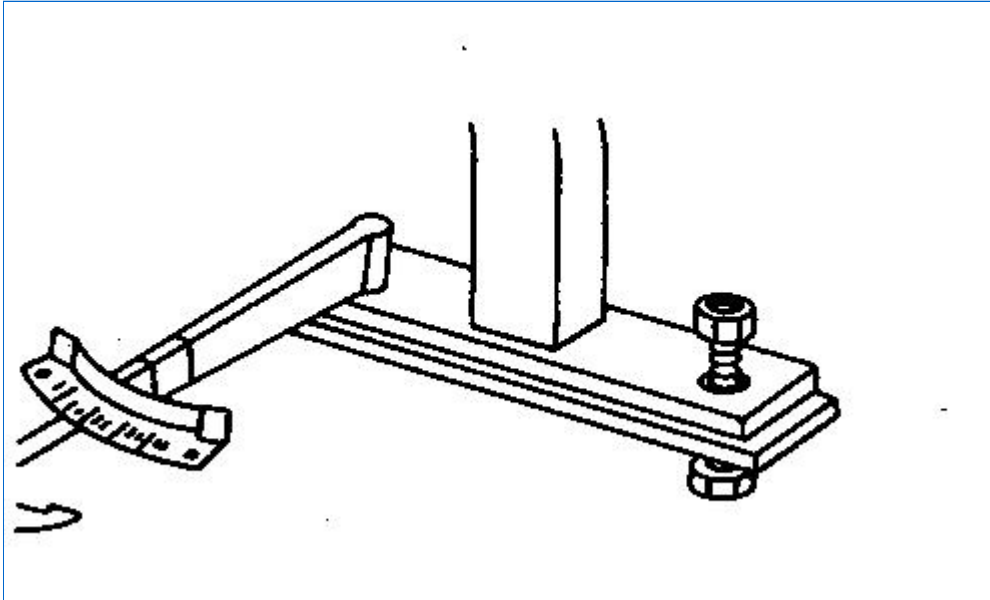

TS212-UN: Roll-Over Protective Structure

Make certain all parts are reinstalled correctly if the roll-over protective structure (ROPS) is loosened or removed for any reason. Tighten mounting bolts to proper torque.

The protection offered by ROPS will be impaired if ROPS is subjected to structural damage, is involved in an overturn incident, or is in any way altered by welding, bending, drilling, or cutting. A damaged ROPS should be replaced, not reused.

The seat is part of the ROPS safety zone. Replace only with John Deere seat approved for your tractor.

Any alteration of the ROPS must be approved by the manufacturer.



Suggest:

For more complete manuals. Please go to the home page.

<https://www.ebooklibonline.com>

If the above button click is invalid. Please download this document first, and then click the above link to download the complete manual.

Thank you so much for reading

OMSU21580 - 5425, 5425 Orchard, 5425HC,5625, 5625HC,5725, 5725 Orchard,and 5725HC Tractors, Operator's Manual (Export Edition, September 2012)
Use Foldable ROPS and Seat Belt Properly

Use Foldable ROPS and Seat Belt Properly

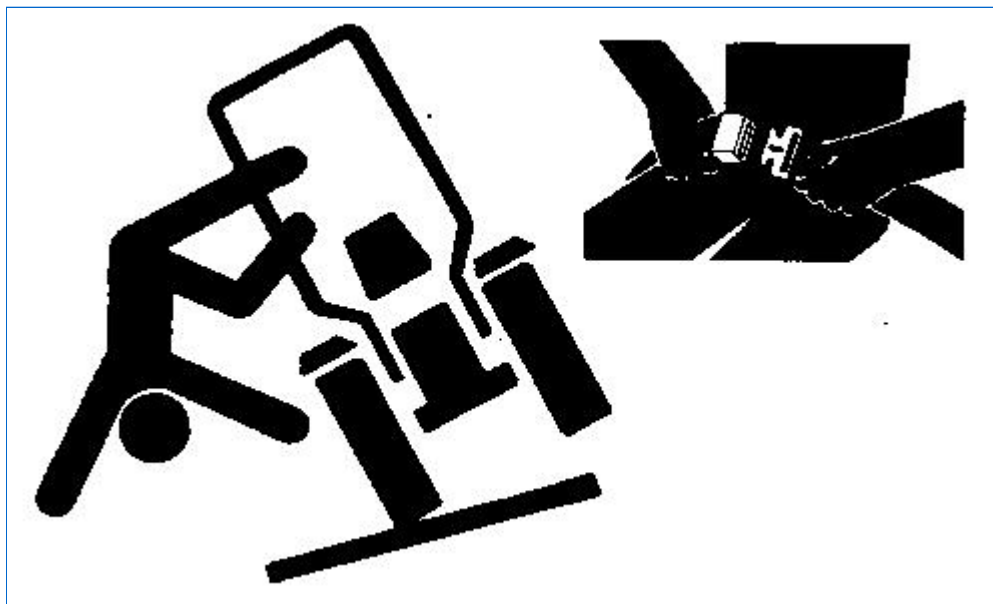

TS205-UN: Fasten Your Seat Belt

If this tractor is equipped with a foldable ROPS, keep the ROPS in the fully extended and locked position. If the tractor is ever operated with ROPS folded (e.g., to enter a low building), drive with extreme caution. Do NOT use seat belt with the ROPS folded.

Return the ROPS to the raised, fully extended and locked position as soon as the tractor is operated under normal conditions. Always fasten your seat belt when the ROPS is fully extended and locked.

Stay Clear of Rotating Drivelines



TS1644-UN: Rotating Drivelines

<https://www.ebooklibonline.com>

Hello dear friend!

Thank you very much for reading.

Enter the link into your browser.

The full manual is available for immediate download.

<https://www.ebooklibonline.com>