

John Deere > Agriculture > TRACTOR > 8345R - TRACTOR > 8345R Tractor (S.N. 100000- )(Engine: 6090HBM02, 6090HBM03, 6090HBM04, 6090HBM05) (South America Edition) > 23 ENGINE 6090HBM02-  
DZ10414 > ST130073 - 1102 ROCKER ARM COVER

KEY	PART NO.	PART NAME	QTY	REMARKS	
1	RE529871	ELBOW FITTING	1	SUB FOR RE527976	
2	T122075	O-RING	1		
3	19M8291	SCREW	15	M8 X 35	
4	RE536705	COVER	1	MARKED R545610; SUB FOR RE529972	
5	R523317	BREATHER	1	SUB FOR R518264	
6	RE526690	CAP SCREW	2		
7	RE526689	CAP SCREW	1		
8	R527884	GASKET	1		

**<https://www.ebooklibonline.com>**

Hello dear friend!

Thank you very much for reading.

Enter the link into your browser.

The full manual is available for immediate download.

**<https://www.ebooklibonline.com>**

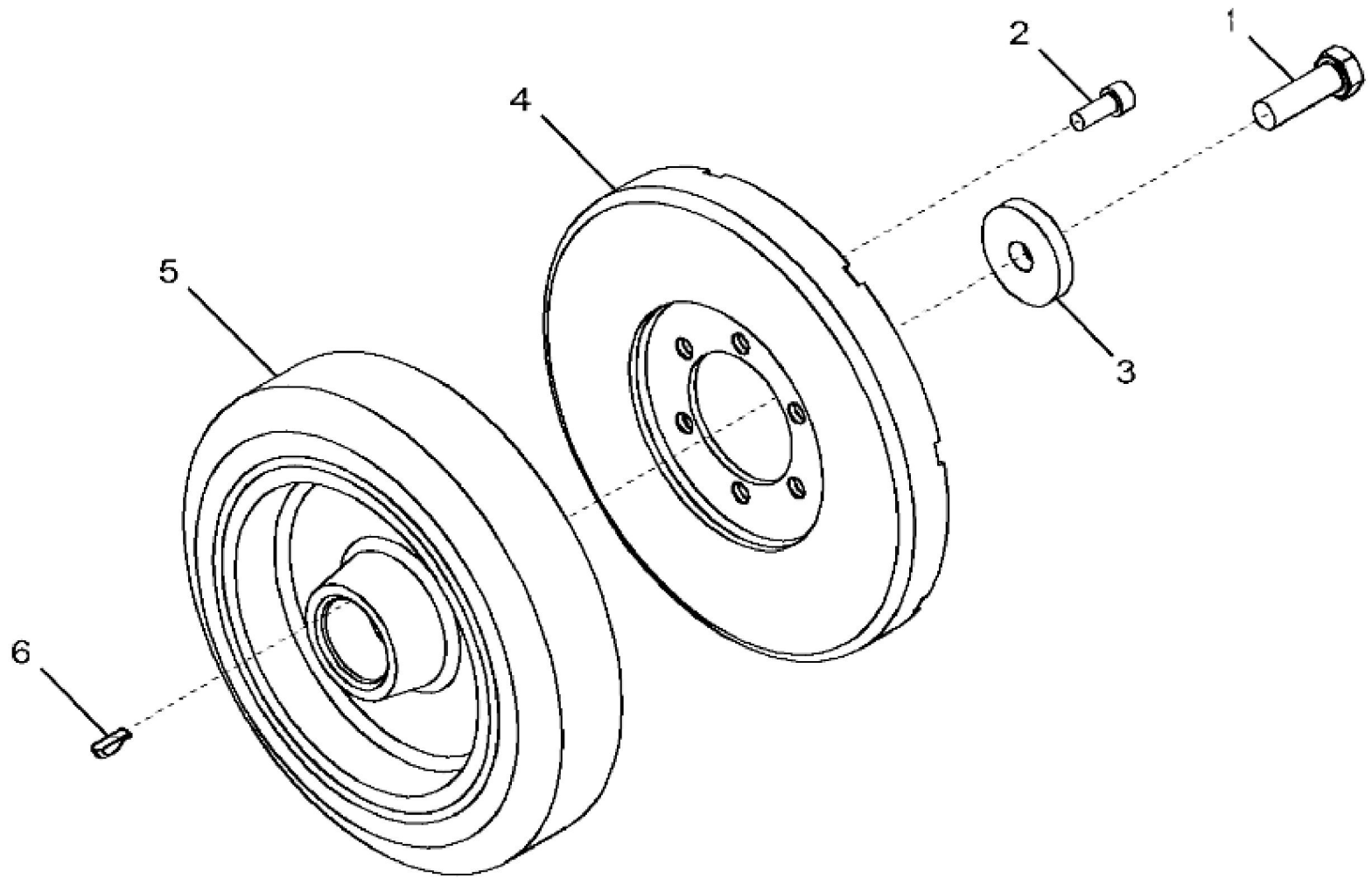

1341\_RE523047\_PCD

John Deere > Agriculture > TRACTOR > 8345R - TRACTOR > 8345R Tractor (S.N. 100000- )(Engine: 6090HBM02, 6090HBM03, 6090HBM04, 6090HBM05) (South America Edition) > 23 ENGINE 6090HBM02-DZ10414 > ST142017 - 1341 DAMPER

KEY	PART NO.	PART NAME	QTY	REMARKS	
1	19M8889	CAP SCREW	1	M16 X 50	
2	19M8533	SCREW	6	M10 X 25	
3	R26333	WASHER	1		
4	RE57604	TORSIONAL DAMPER	1		
5	RE520465	TORSIONAL DAMPER	1		
6	R523306	KEY	1		

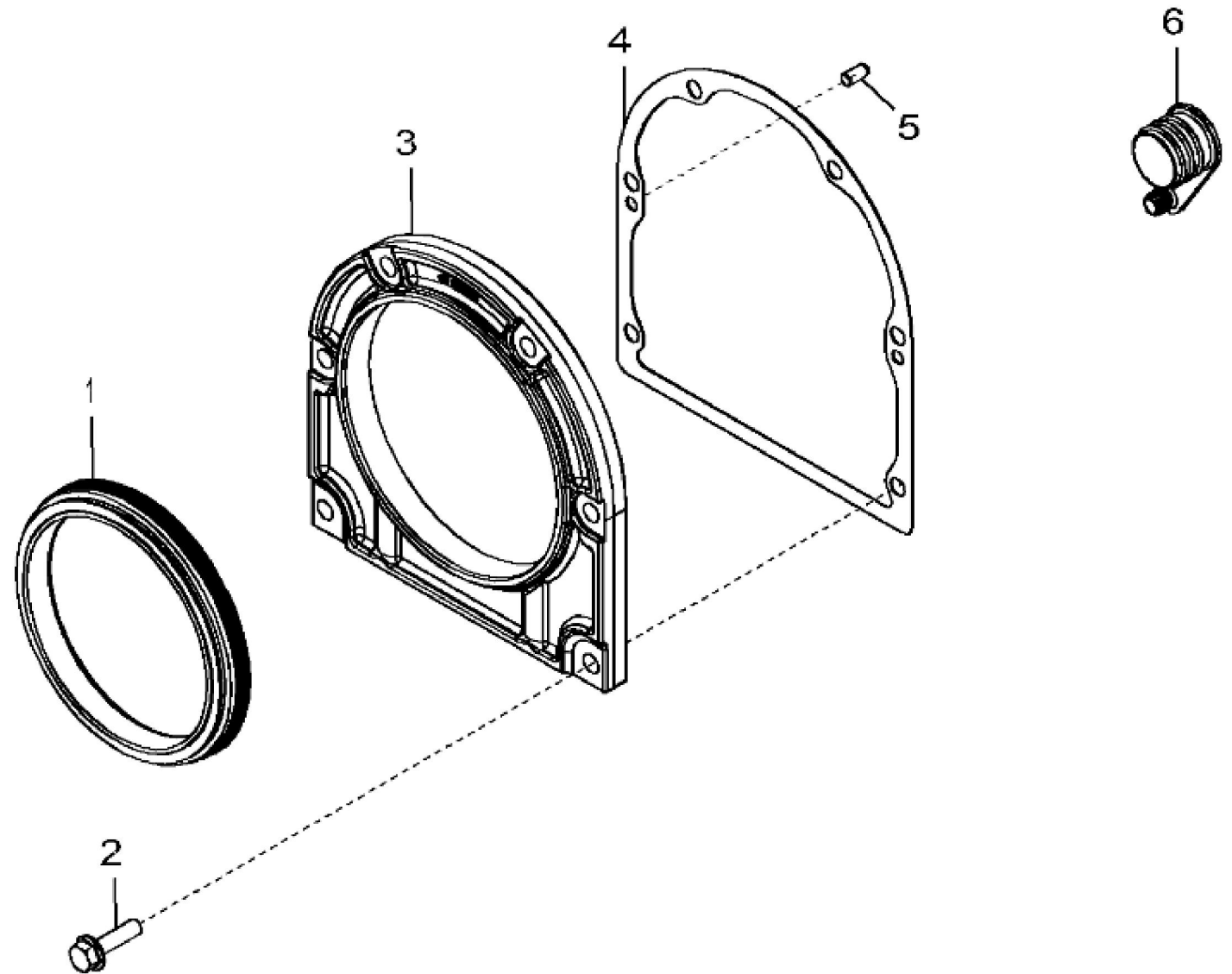



**Suggest:**

**For more complete manuals. Please go to the home page.**

**<https://www.ebooklibonline.com>**

**If the above button click is invalid. Please download this document first, and then click the above link to download the complete manual.**

**Thank you so much for reading**

John Deere > Agriculture >TRACTOR >8345R - TRACTOR >8345R Tractor (S.N. 100000- )(Engine: 6090HBM02, 6090HBM03, 6090HBM04, 6090HBM05) (South America Edition) >23 ENGINE 6090HBM02-DZ10414 >ST386277 - 1499 FLYWHEEL HOUSING

KEY	PART NO.	PART NAME	QTY	REMARKS	
1	RE520036	SEAL	1		
2	19M7868	SCREW	6	M8 X 30	
3	R531312	HOUSING	1	MARKED R545426; SUB FOR R530233 OR R531570	
4	R522768	GASKET	1	SUB FOR R520504	
5	F1743R	DOWEL PIN	2		
6	R121929	PLUG	1		

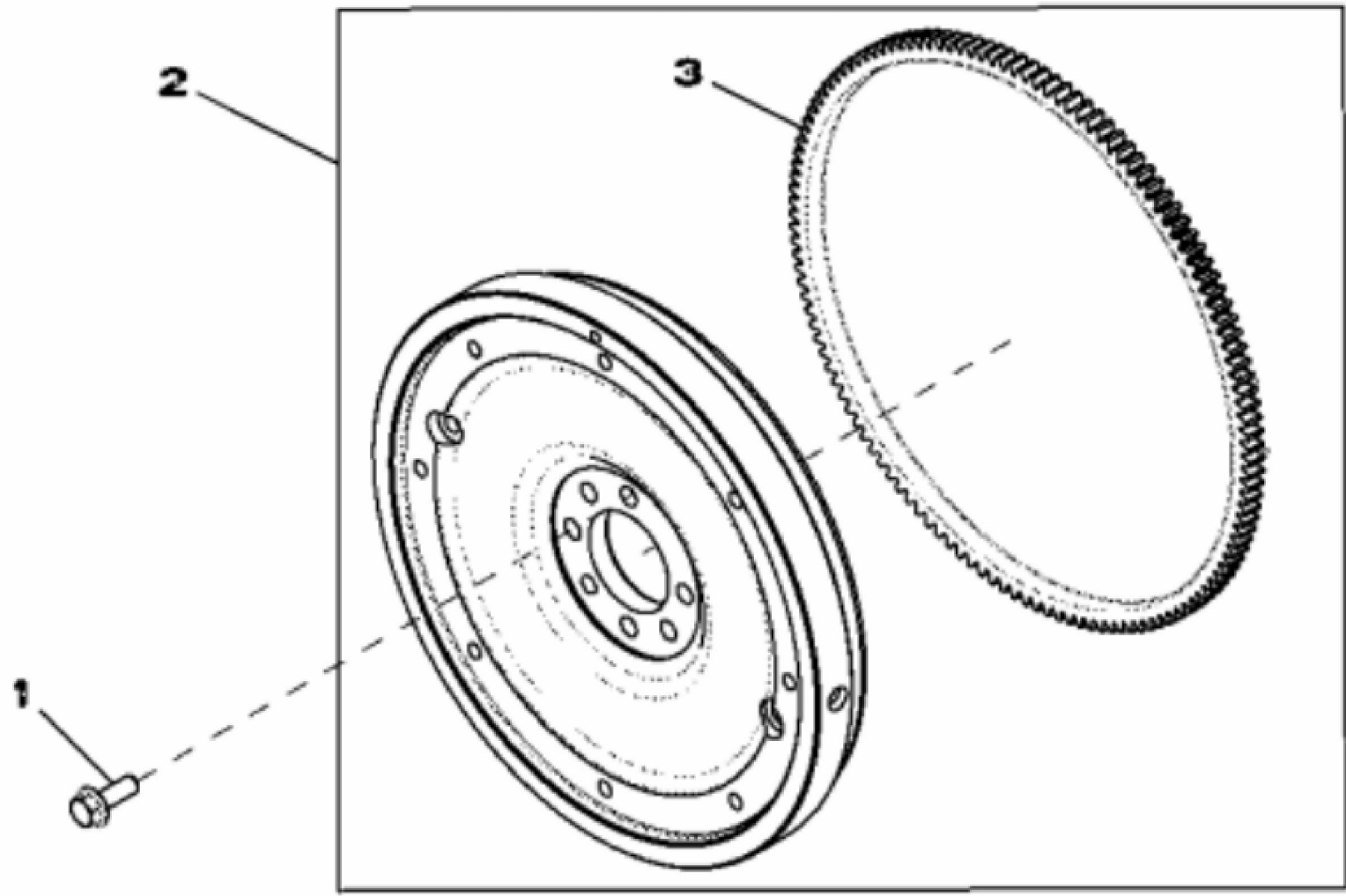

RE522627PCDA02

**<https://www.ebooklibonline.com>**

Hello dear friend!

Thank you very much for reading.

Enter the link into your browser.

The full manual is available for immediate download.

**<https://www.ebooklibonline.com>**