

TX1141021

## CYLINDER BLOCK

KEY	PART NO.	PART NAME	QTY	REMARKS	
2	M809594	PLUG	1		
3	15H562	PIPE PLUG	1	1"	
4	AT211653	BOLT	10		
5	AT211656	BUSHING	1		
6	30M7023	PLUG	8		
7	CH18079	SPRING PIN	2		
8	M806938	PLUG	3		
9	MIA880556	BEARING	2		
10	AT211658	BOLT	18		
11	MIU801057	GASKET	1		
12	MIA880548	BEARING	5		
12	MIA880547	BEARING	1	Undersized, .25 mm	
12	MIA880558	BEARING	1	Oversized, .25 mm	

**<https://www.ebooklibonline.com>**

Hello dear friend!

Thank you very much for reading.

Enter the link into your browser.

The full manual is available for immediate download.

**<https://www.ebooklibonline.com>**

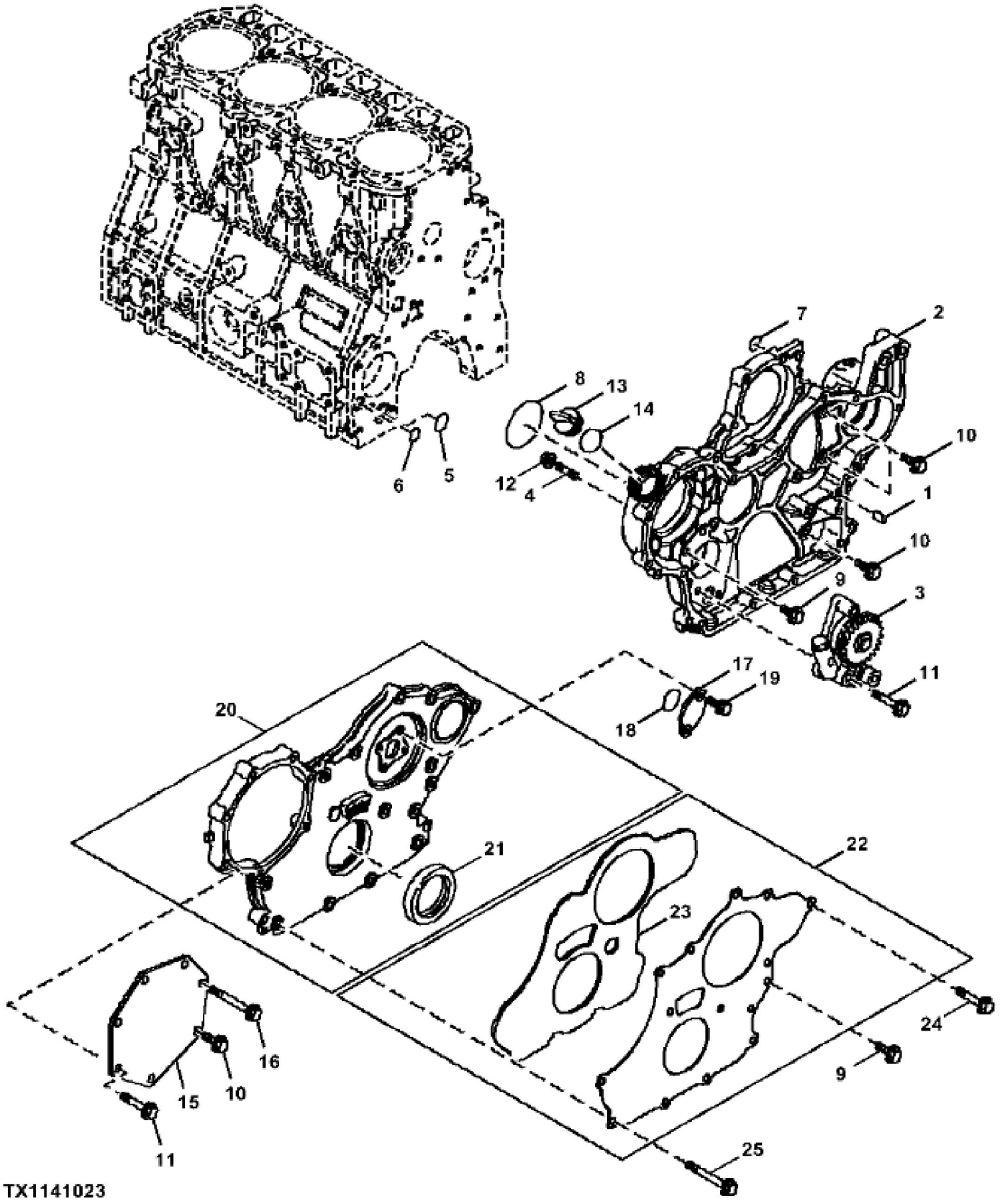

TX1141023

## HOUSING

KEY	PART NO.	PART NAME	QTY	REMARKS	
1	M802255	PIN	4		
2	MIU803576	GEAR CASE	1		
3	AT212086	HYDRAULIC PUMP	1		
4	M800056	STUD	4		
5	AT211670	O-RING	1		
6	AT211671	O-RING	1		
7	CH10567	PACKING	1		
8	MIU801224	PACKING	1		
9	CH18390	BOLT	4		
10	CH19139	BOLT	4		
11	CH19101	BOLT	8		
12	M810187	NUT	4		
13	M805710	CAP	1		
14	M805711	PACKING	1		
15	AT211662	COVER	1		
16	CH19091	BOLT	1		
17	MIU800476	COVER	1		
18	CH13526	PACKING	1		
19	M87868	BOLT	2		
20	.....	HOUSING	1	NLA	
21	MIU801096	SEAL	1		
22	AT211680	COVER	1		
23	AT211681	GASKET	1		
24	M89128	BOLT	5		
25	CH19100	BOLT	6		

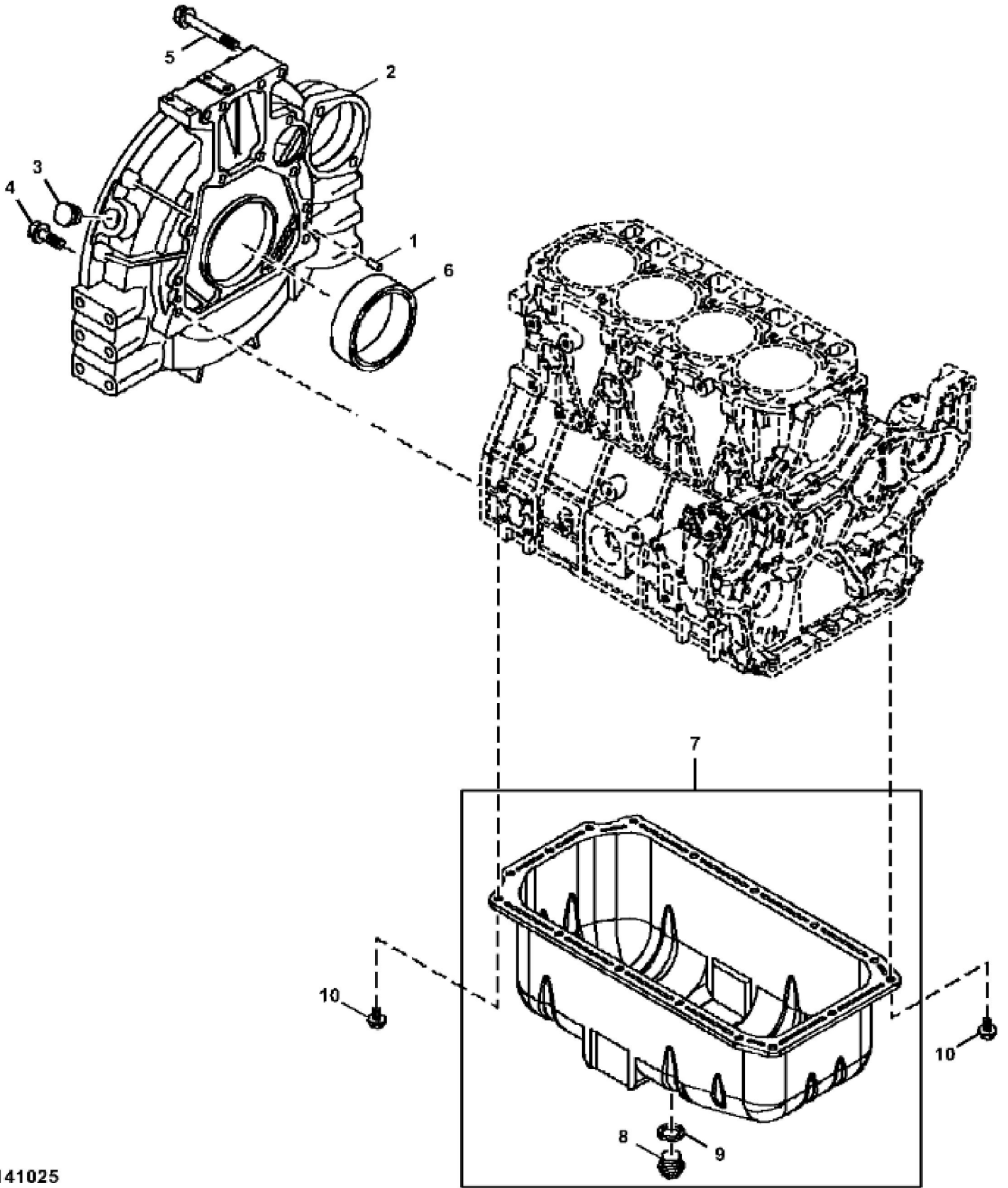

TX1141025



**Suggest:**

**For more complete manuals. Please go to the home page.**

**<https://www.ebooklibonline.com>**

**If the above button click is invalid. Please download this document first, and then click the above link to download the complete manual.**

**Thank you so much for reading**

John Deere > Turf And Utility > LOADER, FOUR-WHEEL DRIVE > 304K - LOADER, FOUR-WHEEL DRIVE > 304K Loader (PIN: 1LU304K\_\_B030847-) > 04 ENGINE > 0400 ENGINE > ST758111 - ENGINE OIL PAN AND FLYWHEEL HOUSING

KEY	PART NO.	PART NAME	QTY	REMARKS	
1	M802255	PIN	2		
2	MIA881092	HOUSING	1		
3	M88659	PLUG	1		
4	AT211675	CAP SCREW	9		
5	AT211950	BOLT	4		
6	MIU801095	SEAL	1		
7	MIA881103	RESERVOIR	1		
8	M806544	DRAIN PLUG	1		
9	M806545	WASHER	1		
10	CH19137	BOLT	16		

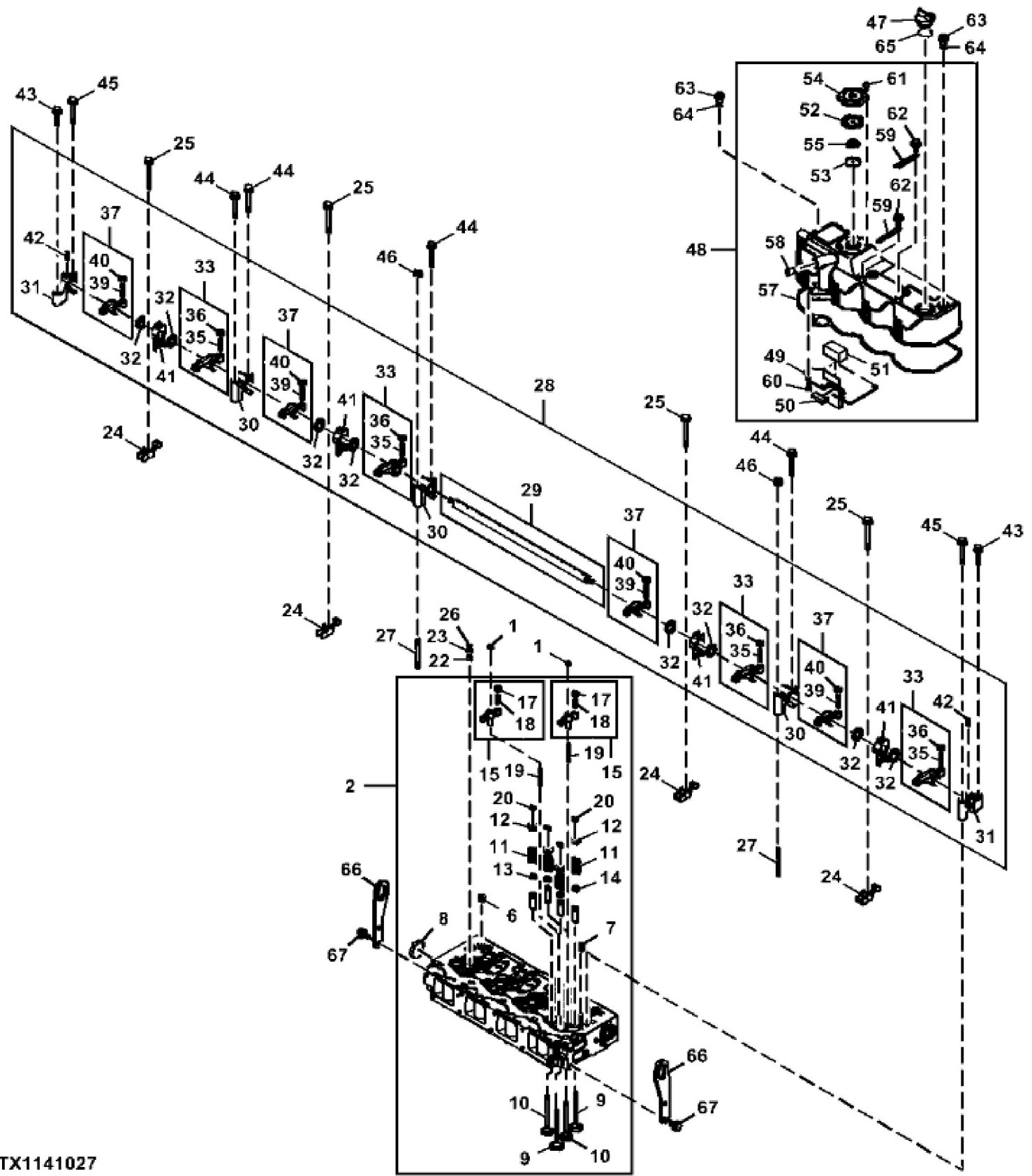

TX1141027

**<https://www.ebooklibonline.com>**

Hello dear friend!

Thank you very much for reading.

Enter the link into your browser.

The full manual is available for immediate download.

**<https://www.ebooklibonline.com>**