

KEY	PART NO.	PART NAME	QTY	Serial No.	REMARKS
1	CH10314	PLUG	3		
2	MIU801572	PLUG	3		
3	MIU801571	PIPE	2		
4	MIU801573	BOLT	16		
5	M808706	PLUG	1		
6	30M7023	PLUG	4		Cap, Metal
7	MIA881538	BEARING	4		Main
7	MIA881539	BEARING	4		0.25, US
8	MIA881540	THRUST BEARING	2		STD
8	MIA881541	BEARING	2		0.25, OS Main
9	M800970	BOLT	14		
10	MIA882277	GASKET KIT	1		Head
11	MIU801570	GASKET	1		
12	MIU802524	BOLT	4		M8 X 1.25
13	MIU800347	SEAL	1		
14	AT211671	O-RING	1		
15	MIU801615	GASKET	1		Pump
16	E63525	NUT	1		
17	MIU804312	LIFTER KIT	1	040001-_____	SUB FOR APPL MIU803028
18	CH19780	BOLT	2	040001-_____	
19	MIA882682	SHORT BLOCK ASSEMBLY	1		Not Illustrated SUB FOR MIA881533
19	MIA884538	SHORT BLOCK ASSEMBLY	1		Not Illustrated

**<https://www.ebooklibonline.com>**

Hello dear friend!

Thank you very much for reading.

Enter the link into your browser.

The full manual is available for immediate download.

**<https://www.ebooklibonline.com>**

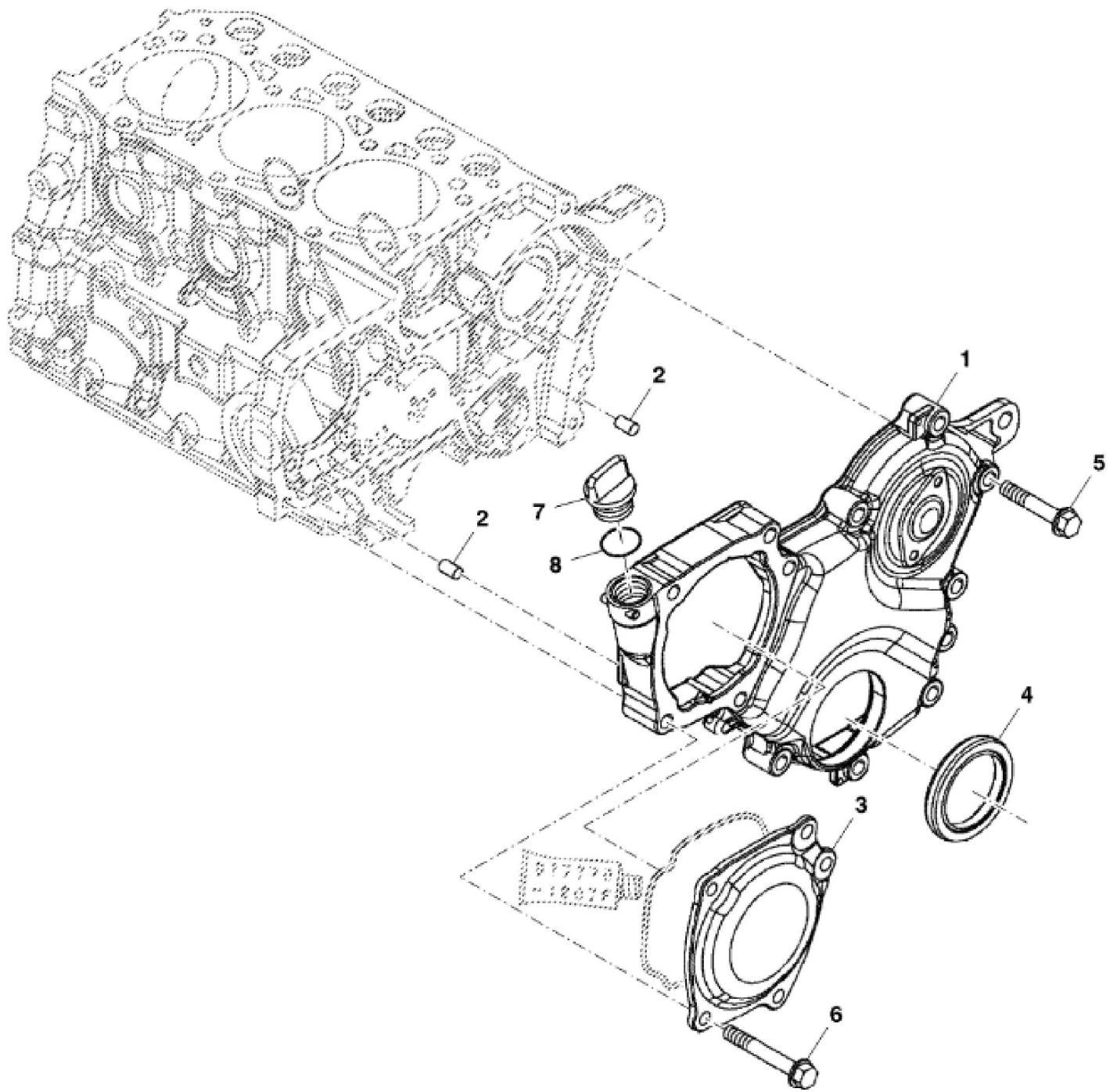

PU06654

John Deere > Turf And Utility >TRACTOR, LAWN AND GARDEN >X750 - TRACTOR, LAWN AND GARDEN >X750 Signature Series Tractor >20 ENGINE 3TNM74F-NBJLT ETN171094 >ST743528 - GEAR HOUSING

KEY	PART NO.	PART NAME	QTY	REMARKS	
1	MIU801540	GEAR CASE	1		
2	M802254	PIN	2		
3	MIU801568	COVER	1	Pump Timing	
4	M811563	SEAL	1		
5	19M7897	SCREW	8	M8 X 35	
6	CH19101	BOLT	5		
7	MIU801536	CAP	1		
8	CH14634	O-RING	1		

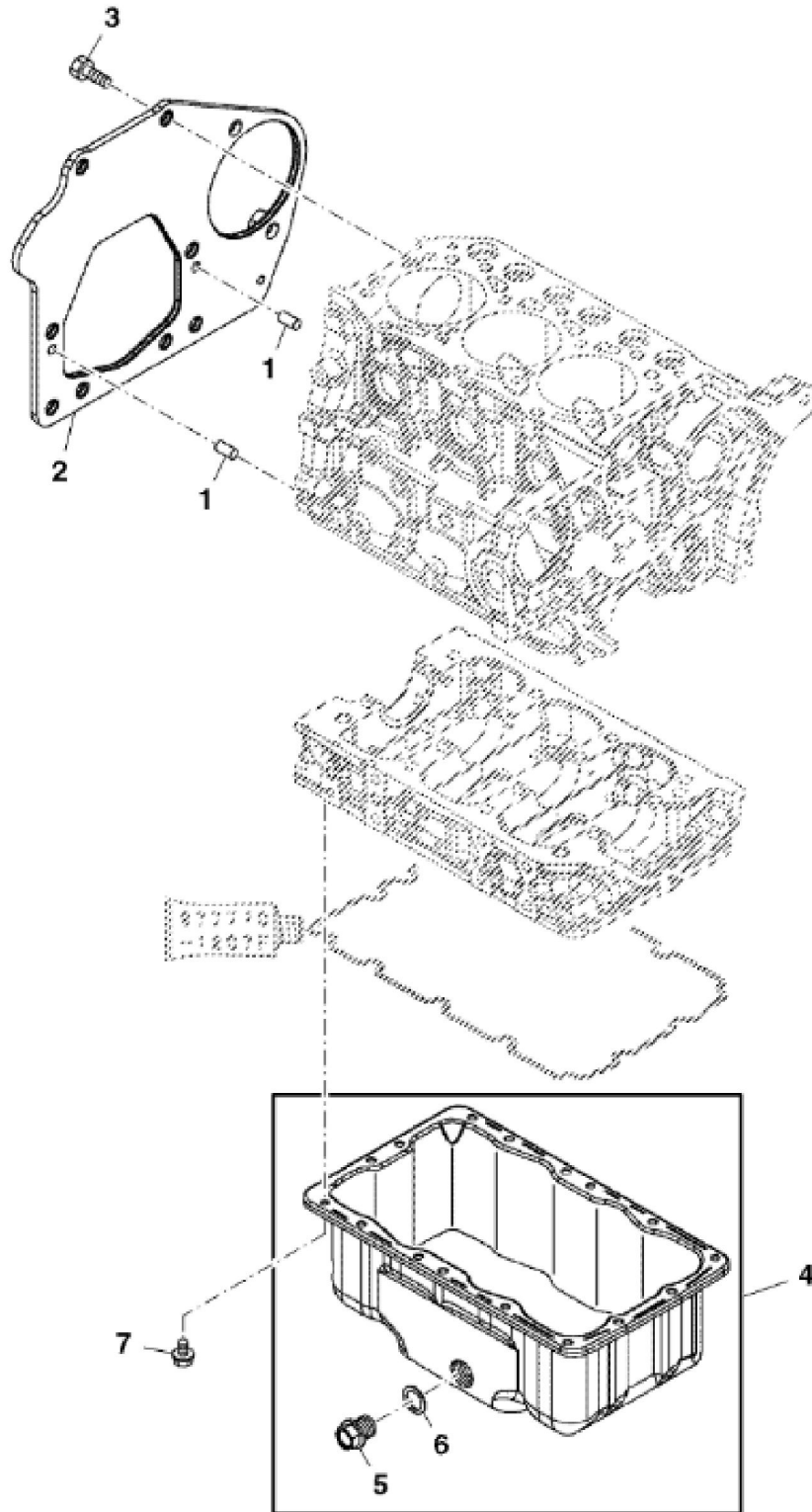



**Suggest:**

**For more complete manuals. Please go to the home page.**

**<https://www.ebooklibonline.com>**

**If the above button click is invalid. Please download this document first, and then click the above link to download the complete manual.**

**Thank you so much for reading**

John Deere > Turf And Utility >TRACTOR, LAWN AND GARDEN >X750 - TRACTOR, LAWN AND GARDEN >X750 Signature Series Tractor >20 ENGINE 3TNM74F-NBJLT ETN171094 >ST743530 -  
MOUNTING FLANGE AND OIL SUMP

KEY	PART NO.	PART NAME	QTY	REMARKS	
1	M802255	PIN	2		
2	MIU802564	FLANGE FITTING	1		
3	M800011	BOLT	8		
4	MIA881596	RESERVOIR	1		
5	T111565	PLUG	1		
6	M806433	WASHER	1	SUB FOR M811568	
7	MIU801569	BOLT	16		

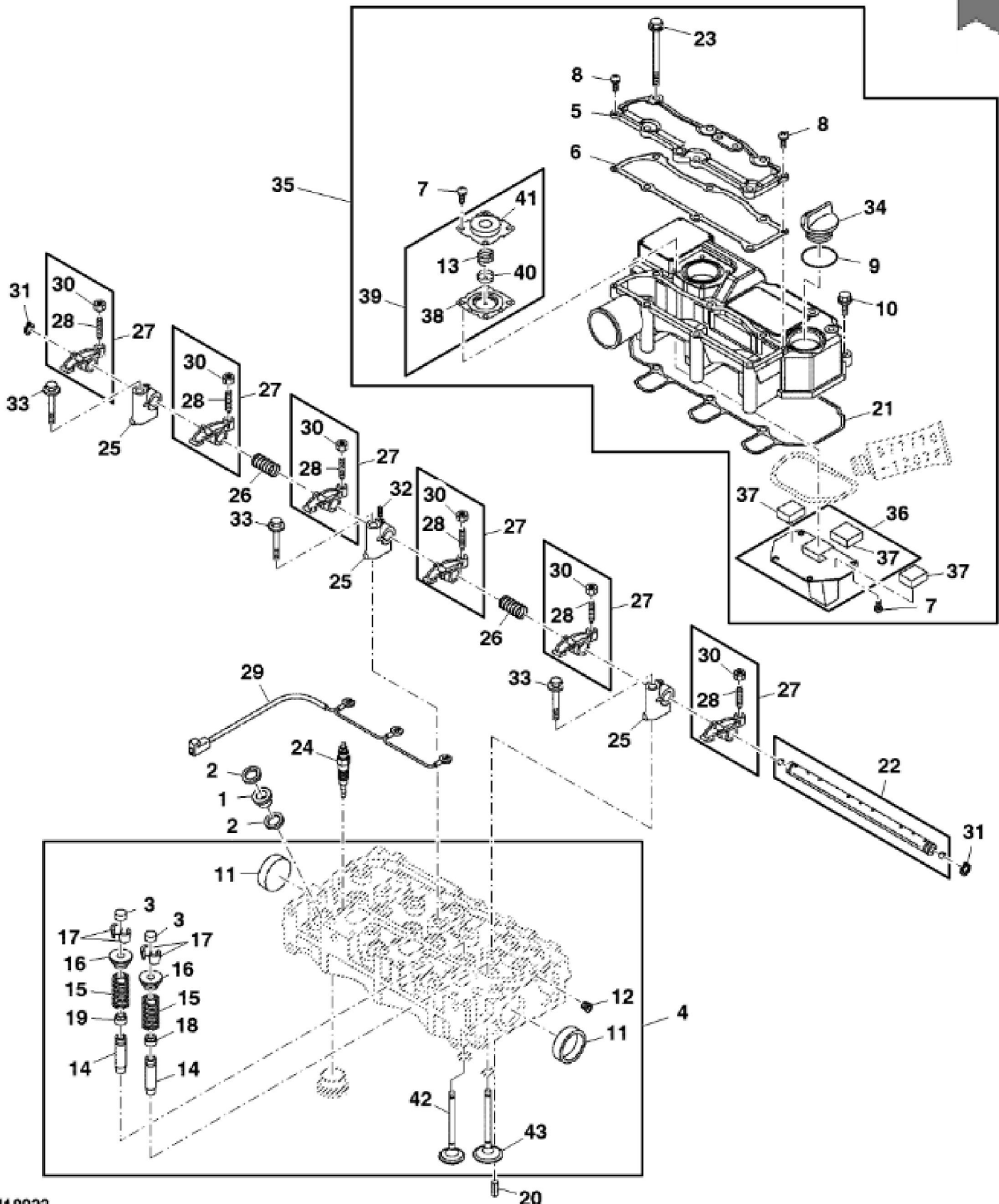

**<https://www.ebooklibonline.com>**

Hello dear friend!

Thank you very much for reading.

Enter the link into your browser.

The full manual is available for immediate download.

**<https://www.ebooklibonline.com>**