

PU12405

John Deere > Turf And Utility >TRACTOR, LAWN AND GARDEN >X738 - TRACTOR, LAWN AND GARDEN >X738 Signature Series Tractor >20 ENGINE MM16177 >ST747644 - CYLINDER HEAD AND CRANKCASE

KEY	PART NO.	PART NAME	QTY	REMARKS
1	M147294	VALVE COVER	1	RH
2	19M8903	SCREW	11	M6 X 30
3	MIU11493	BOLT	8	
4	M147297	GASKET	2	
5	MIU11492	BOLT	4	
6	M68144	STUD	4	MARKED FD750D-JS12; ORDER MIU11949
6	MIU11949	BOLT	1	
7	AM132281	CYLINDER HEAD	1	ORDER MIU14324; RH
7	MIU14324	CYLINDER HEAD	1	MARKED FD750D-NS12; RH
8	M147293	ENGINE CYLINDER HEAD GASKET	2	
9	MIU14325	CYLINDER HEAD	1	SUB FOR AM132282
10	M147295	VALVE COVER	1	LH
11	M77734	CLAMP	2	
12	M147307	TUBE	1	
13	19M7868	SCREW	4	M8 X 30
14	M147299	COVER	1	
15	M95848	SCREW	2	
16	M147298	PLATE	2	
17	M147300	VALVE	2	Breather
18	M147296	GASKET	1	
19	M147302	SEAL	1	
20	MIU12134	BEARING	1	
21	M127431	ADAPTER FITTING	3	USE WITH AM132283
21	MIU13767	ADAPTER FITTING	1	MARKED FD750D-NS12
22	MIA12868	CRANKCASE	1	SUB FOR AM132283
22	MIA12868	CRANKCASE	1	MARKED FD750D-NS12
23	M70227	PIN	6	
24	M76104	O-RING	3	
25	MIU10833	SEAL	1	
26	19M8318	SCREW	6	M8 X 45
27	M139490	BOLT	4	MARKED FD750D-JS12
27	MIU11385	BOLT	1	MARKED FD750D-NS12
28	MIA12867	CRANKCASE	1	SUB FOR M147763; Cover
29	M147303	SEAL	1	

**<https://www.ebooklibonline.com>**

Hello dear friend!

Thank you very much for reading.

Enter the link into your browser.

The full manual is available for immediate download.

**<https://www.ebooklibonline.com>**

KEY	PART NO.	PART NAME	QTY	REMARKS
30	24M7095	WASHER	12	8.400 X 15 X 1.600 mm, Head Bolt
31	MIU14326	BEARING	1	USE WITH MIA12867
32	M70227	PIN	6	
33	M94242	BOLT	8	(Not Illustrated)
34	MIA12032	GASOLINE ENGINE	1	(Not Illustrated) MARKED FD750D-HS12; ORDER MIA12550
34	MIA12550	GASOLINE ENGINE	1	(Not Illustrated) MARKED FD750D-JS12; ORDER MIA12563
34	MIA12563	GASOLINE ENGINE	1	(Not Illustrated) MARKED FD750D-KS12; ORDER MIA12669
34	MIA12669	GASOLINE ENGINE	1	(Not Illustrated) MARKED FD750D-MS12; ORDER MIA12821
34	MIA12821	GASOLINE ENGINE	1	(Not Illustrated) MARKED FD750D-NS12
35	MIA12917	SHORT BLOCK ASSEMBLY	1	(Not Illustrated) SUB FOR MIA11876

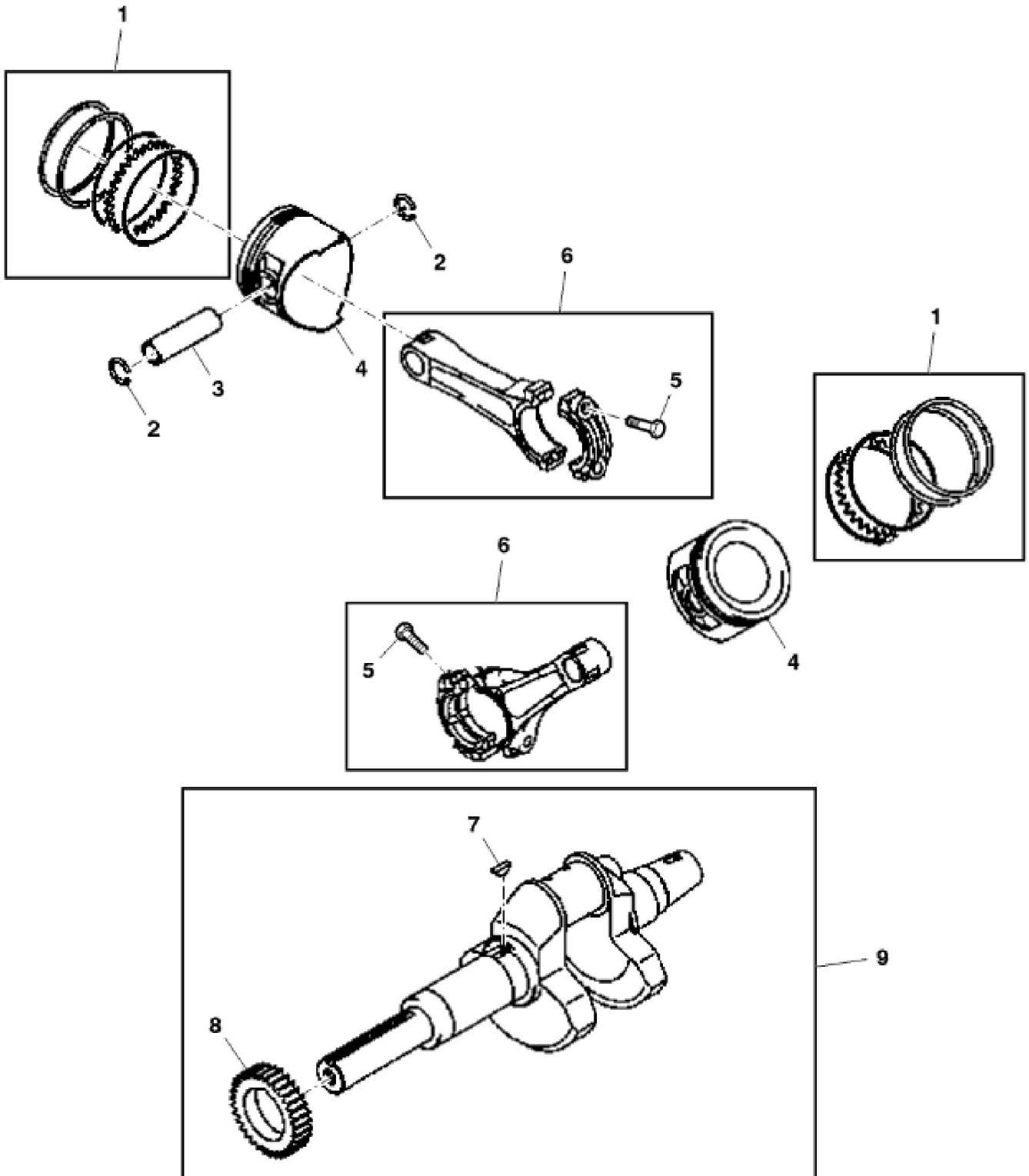

John Deere > Turf And Utility >TRACTOR, LAWN AND GARDEN >X738 - TRACTOR, LAWN AND GARDEN >X738 Signature Series Tractor >20 ENGINE MM16177 >ST747646 - CRANKSHAFT AND PISTON ASSEMBLY

KEY	PART NO.	PART NAME	QTY	REMARKS
1	AM102610	PISTON RING KIT	2	
1	AM102612	PISTON RING KIT	2	0.50 mm, OS
2	M70220	SNAP RING	4	
3	M70219	PISTON PIN	2	
4	MIU14328	PISTON	2	SUB FOR M119153; STD
4	M119174	PISTON	2	0.50 mm, OS
5	M147310	BOLT	2	
6	MIA11872	CONNECTING ROD	2	
7	M77843	SHAFT KEY	1	
8	M147309	SPUR GEAR	1	USE WITH MIA10555 AND MIA11873
8	MIU14329	SPUR GEAR	1	MARKED FD750D-NS12
9	MIA11873	CRANKSHAFT	1	ORDER MIA12869
9	MIA12869	CRANKSHAFT	1	

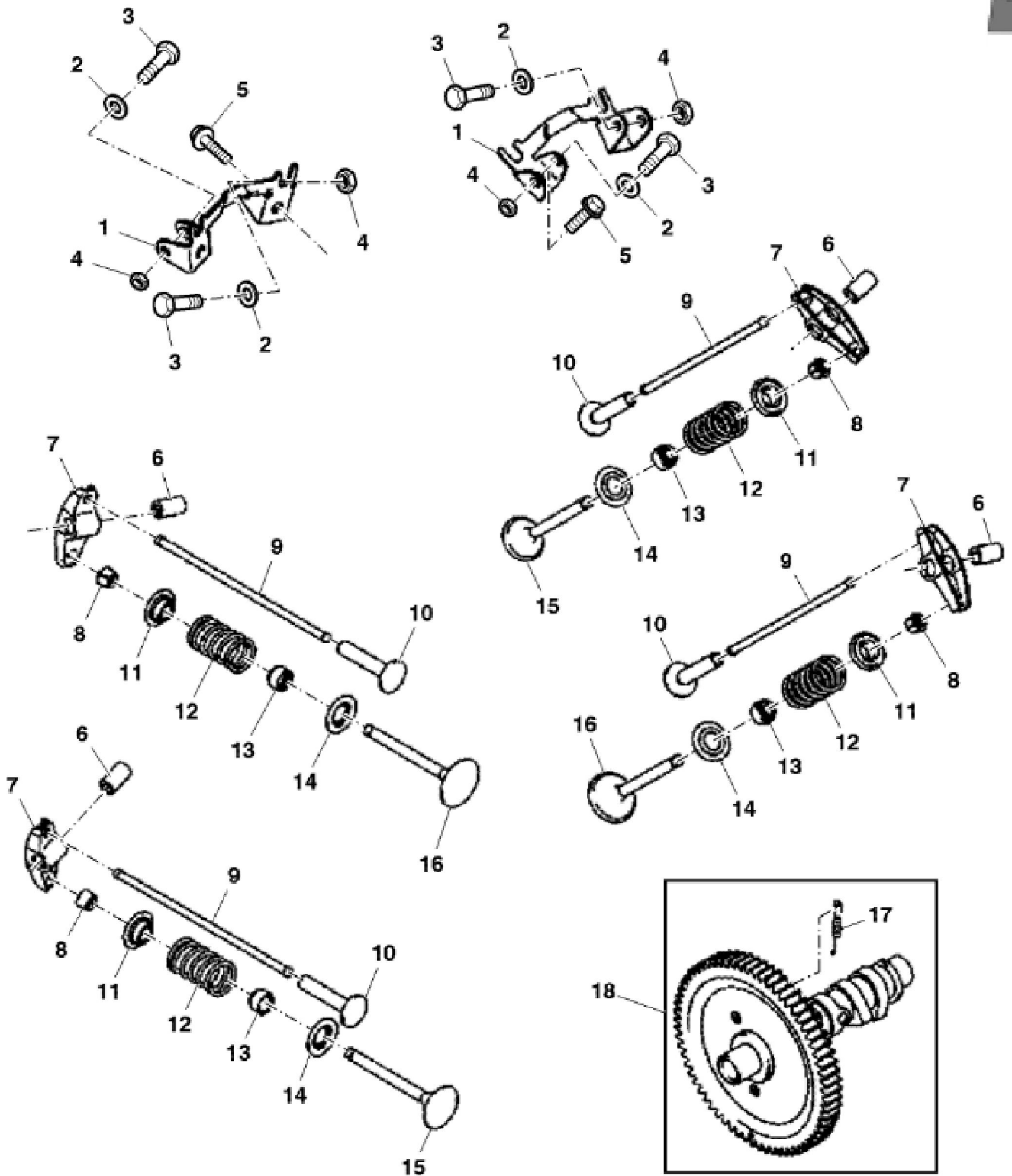



**Suggest:**

**For more complete manuals. Please go to the home page.**

**<https://www.ebooklibonline.com>**

**If the above button click is invalid. Please download this document first, and then click the above link to download the complete manual.**

**Thank you so much for reading**

KEY	PART NO.	PART NAME	QTY	REMARKS	
1	M147311	BRACKET	2		
2	M147320	WASHER	4		
3	M147317	BOLT	4		
4	14M7272	NUT	5	M6	
5	M147319	BOLT	4		
6	M147318	BUSHING	4		
7	MIU14434	ROCKER ARM	4	SUB FOR M147314	
8	AM132412	RETAINER	4		
9	M147315	PUSH ROD	4		
10	M70213	TAPPET	4		
11	M72322	WIRE	4		
12	M70206	SPRING	4		
13	M70034	SEAL	4		
14	M70033	SEAT	4	Spring	
15	M147313	EXHAUST VALVE	2	Exhaust	
16	M147312	INTAKE VALVE	2	Intake	
17	M147316	SPRING	1		
18	MIA12870	CAMSHAFT	1	SUB FOR AM132286	

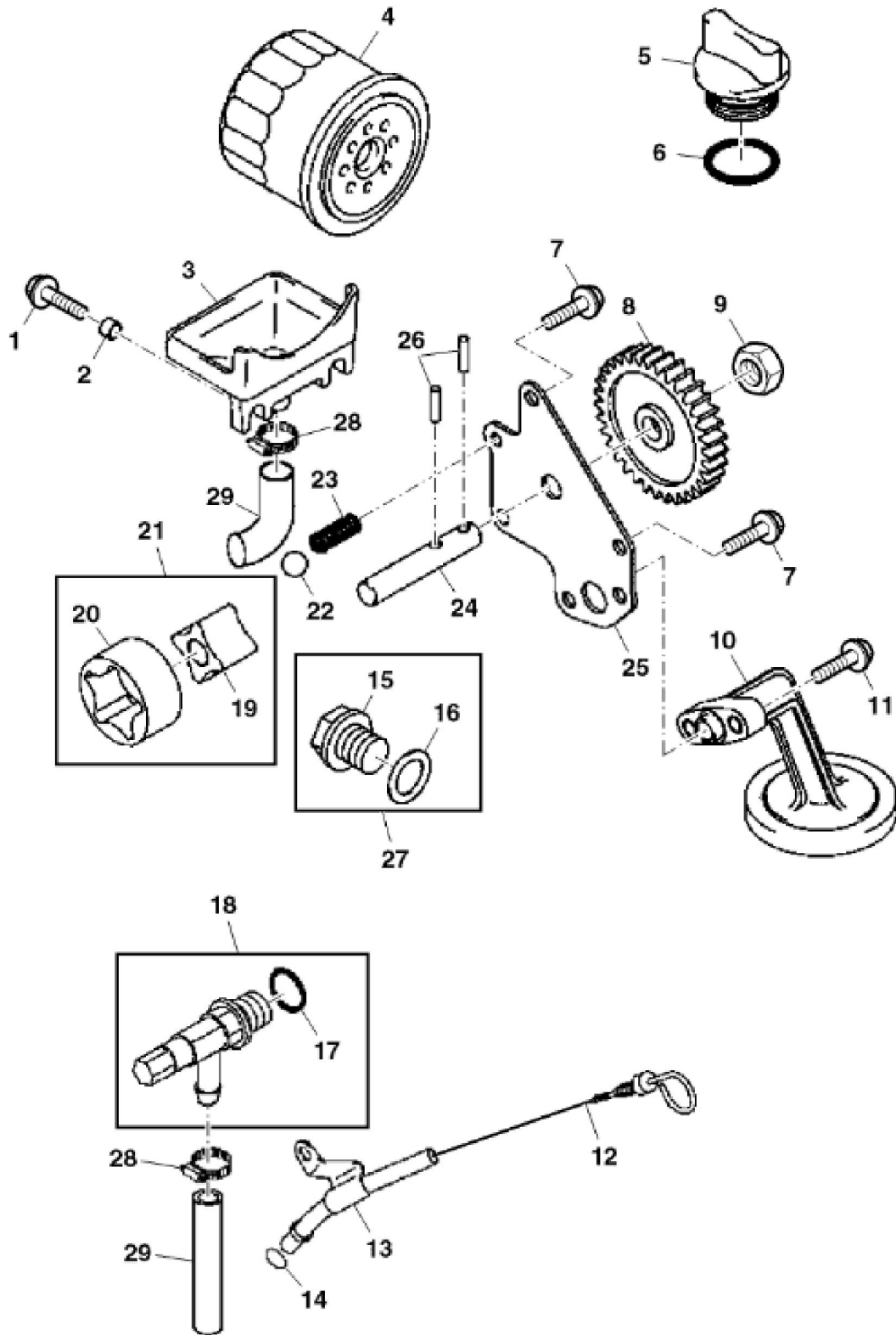

**<https://www.ebooklibonline.com>**

Hello dear friend!

Thank you very much for reading.

Enter the link into your browser.

The full manual is available for immediate download.

**<https://www.ebooklibonline.com>**