

PU10701

BLOCK

KEY	PART NO.	PART NAME	QTY	REMARKS
1	MIA880914	CYLINDER BLOCK	1	
2	CH10314	PLUG	1	
3	M809565	DRAIN PLUG	1	
4	CH10335	PLUG	3	
5	M801189	BOLT	8	
6	MIU800573	BUSHING	1	
7	M87801	PLUG	2	
8	30M7023	PLUG	6	
9	M802255	PIN	4	
10	M800974	PIPE	2	
11	MIA880555	BEARING	2	
11	MIA882809	BEARING KIT	2	
12	MIU800797	SHAFT	1	
13	T110724	CHECK VALVE	3	INCLUDES (3) T111560 AND M811591
13	T111560	RING	3	
13	M811591	BALL	1	
14	MIA880554	BEARING	4	
14	MIA880550	BEARING	4	
15	T110725	NOZZLE	3	
16	CH15575	PIN	3	
17	CH18079	SPRING PIN	2	
18	M801186	BOLT	14	
19	M806440	ENGINE CYLINDER HEAD GASKET	1	
20	15H562	PIPE PLUG	1	1"

<https://www.ebooklibonline.com>

Hello dear friend!

Thank you very much for reading.

Enter the link into your browser.

The full manual is available for immediate download.

<https://www.ebooklibonline.com>

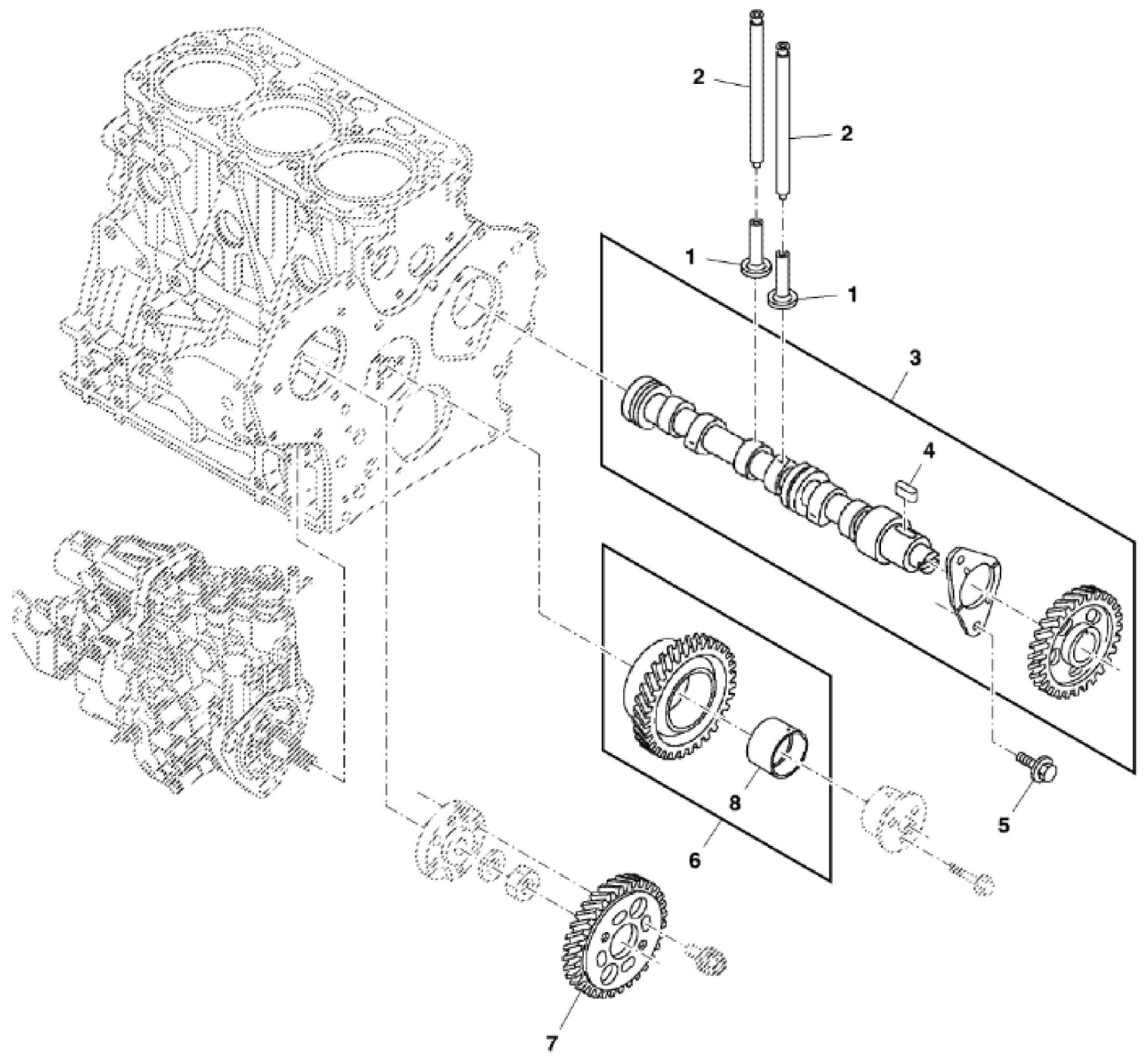

PU10737

John Deere > Turf And Utility > MOWER, FAIRWAY > 7700A - MOWER, FAIRWAY > 7700A PrecisionCut Fairway Mower > 20 ENGINE, 3TNV84T-BMJFW, NON TIER 4 TCM11889 > ST776792 - CAMSHAFT AND DRIVING GEAR

KEY	PART NO.	PART NAME	QTY	REMARKS	
1	M801046	CAM FOLLOWER	6		
2	M801238	PUSH ROD	6		
3	AM876430	CAMSHAFT	1		
4	M801045	SHAFT KEY	1		
5	CH19780	BOLT	2		
6	MIA880571	IDLER GEAR	1		
7	M811057	GEAR	1		
8	MIU800595	BUSHING	1		

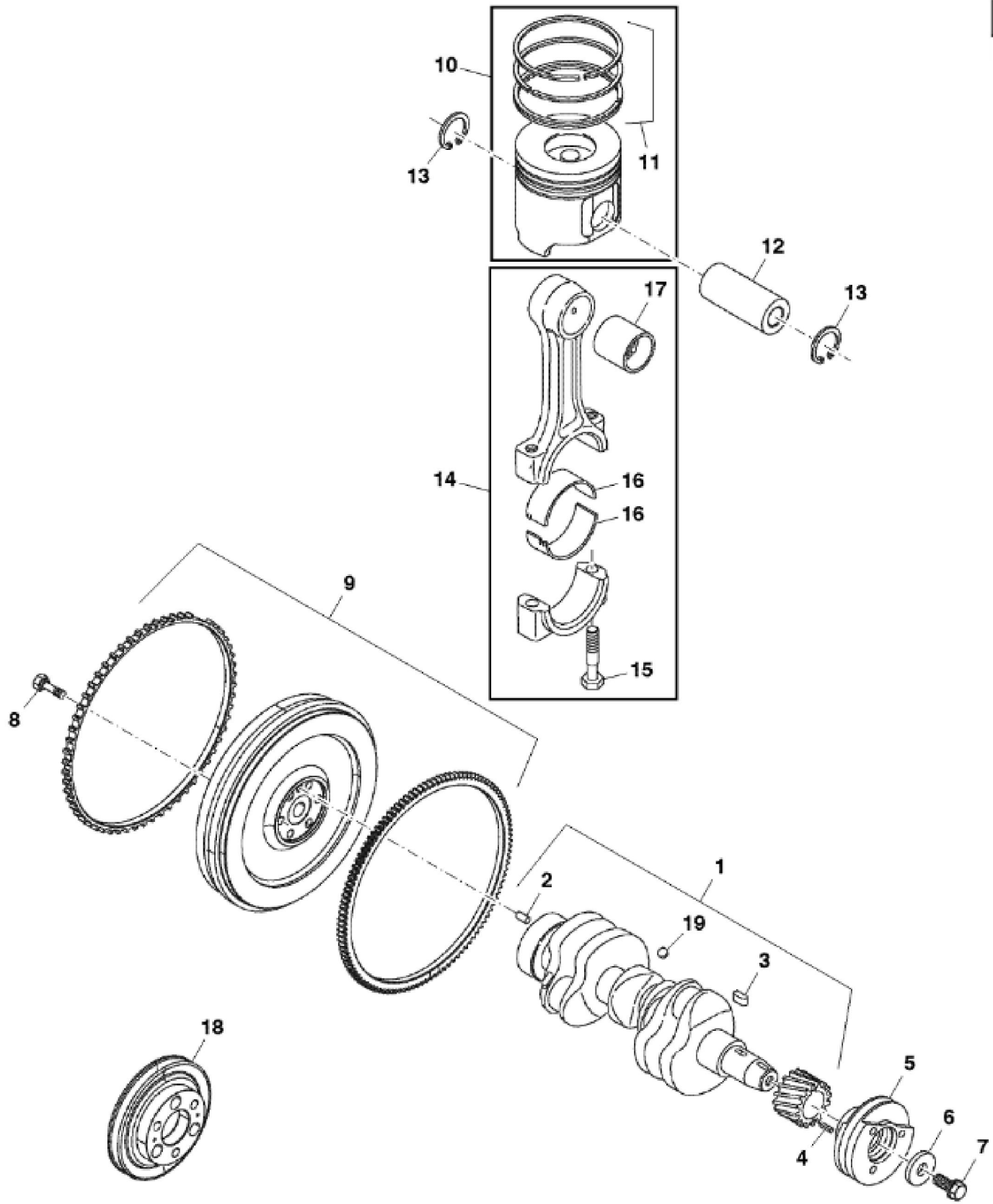

PU10739



Suggest:

For more complete manuals. Please go to the home page.

<https://www.ebooklibonline.com>

If the above button click is invalid. Please download this document first, and then click the above link to download the complete manual.

Thank you so much for reading

John Deere > Turf And Utility > MOWER, FAIRWAY > 7700A - MOWER, FAIRWAY > 7700A PrecisionCut Fairway Mower > 20 ENGINE, 3TNV84T-BMJFW, NON TIER 4 TCM11889 > ST776728 - CRANKSHAFT AND PISTON

KEY	PART NO.	PART NAME	QTY	REMARKS
1	MIA880874	CRANKSHAFT	1	
2	M802255	PIN	1	
3	M801045	SHAFT KEY	1	
4	CH15575	PIN	1	
5	M811430	PULLEY	1	
6	M801055	WASHER	1	
7	CH16798	BOLT	1	
8	CH19291	BOLT	6	
9	MIA883120	FLYWHEEL KIT	1	
10	AM882592	PISTON	3	
10	AM882594	PISTON	3	0.25 OS
10	AM881939	PISTON	1	USE WITH MIA882688
11	AM882593	PISTON	3	
11	AM882595	PISTON RING KIT	3	0.25 OS
11	AM881940	PISTON RING KIT	1	USE WITH MIA882688
12	M806456	PISTON PIN	3	
13	M806457	CLIP	6	
14	AM875391	CONNECTING ROD	3	
15	CH15483	BOLT	6	
16	MIA880563	BEARING	3	
16	MIA880568	BEARING	3	0.25 OS
17	M801256	BEARING	3	
18	MIU803358	PULLEY	1	PTO Shaft
19	400R	BALL	3	

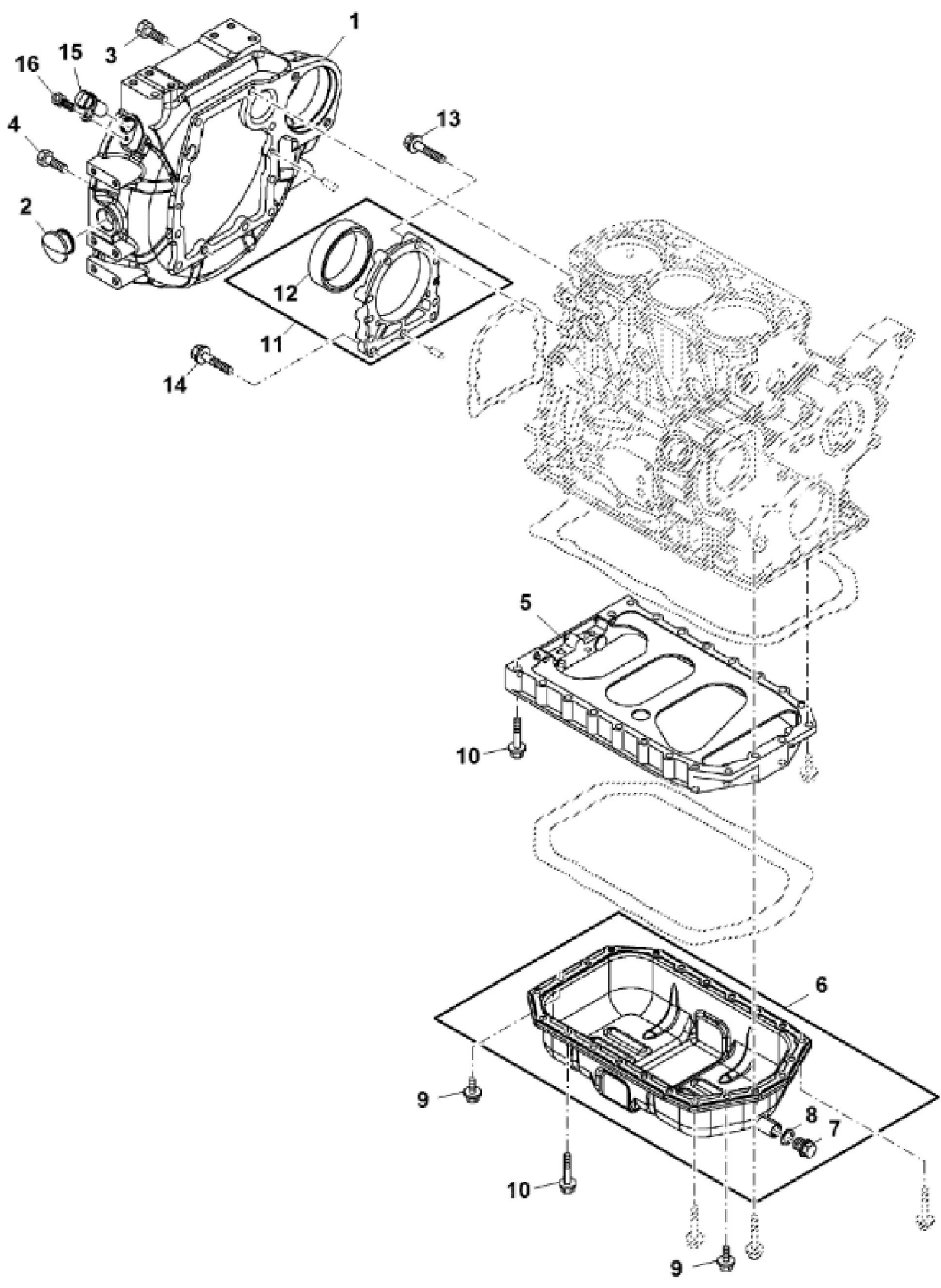

TC279382AR1

<https://www.ebooklibonline.com>

Hello dear friend!

Thank you very much for reading.

Enter the link into your browser.

The full manual is available for immediate download.

<https://www.ebooklibonline.com>