



Service Repair Manual

Model

322 L, 322 LN AND
322 N EXCAVATOR

[Previous Screen](#)

Product: EXCAVATOR

Model: 322 LN EXCAVATOR 4RM

Configuration: 322 L, 322 LN AND 322 N EXCAVATORS 4RM00001-UP (MACHINE) POWERED BY 3116 ENGINE

Disassembly and Assembly

446 and 446B Backhoe Loaders, Lexion 450 Combine, 3114 and 3116 Engines, IT18F Integrated Toolcarrier, D6M Track-Type Tractor and 928F, 950F and 950G Wheel Loaders

Media Number -SEN3611-18

Publication Date -01/05/2009

Date Updated -27/05/2009

i01928381

Governor - Remove

SMCS - 1264-011

Removal Procedure

Table 1

Required Tools			
Tool	Part Number	Part Description	Qty
A	136-4149	Governor Pliers ⁽¹⁾	1

⁽¹⁾ This tool is part of the 128-8822 Fuel System and Governor Tool Group.

Start By:

- a. Remove the fuel shutoff solenoid. Refer to Disassembly and Assembly, "Fuel Shutoff Solenoid - Remove and Install".

NOTICE

Care must be taken to ensure that fluids are contained during performance of inspection, maintenance, testing, adjusting, and repair of the product. Be prepared to collect the fluid with suitable containers before opening any compartment or disassembling any component containing fluids.

Refer to Special Publication, NENG2500, "Dealer Service Tool Catalog" for tools and supplies suitable to collect and contain fluids on Cat products.

Dispose of all fluids according to local regulations and mandates.

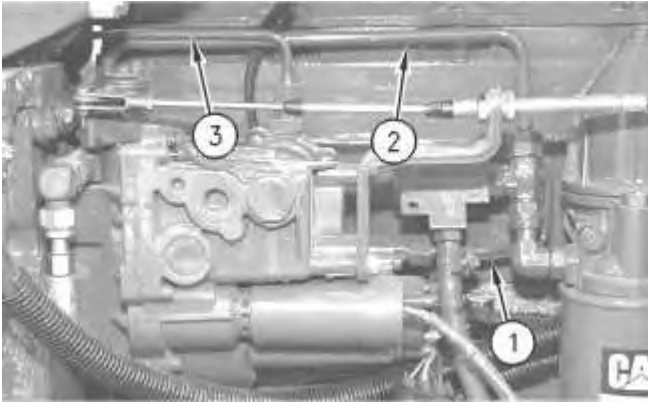

Illustration 1

g00613041

1. Disconnect the governor control cable.
2. Remove oil tube assembly (1). Remove tube assembly (2) and tube assembly for fuel ratio control (3), if equipped. Plug and cap all connections.



Illustration 2

g00613071

3. Remove clip (4).
-

<https://www.ebooklibonline.com>

Hello dear friend!

Thank you very much for reading.

Enter the link into your browser.

The full manual is available for immediate download.

<https://www.ebooklibonline.com>

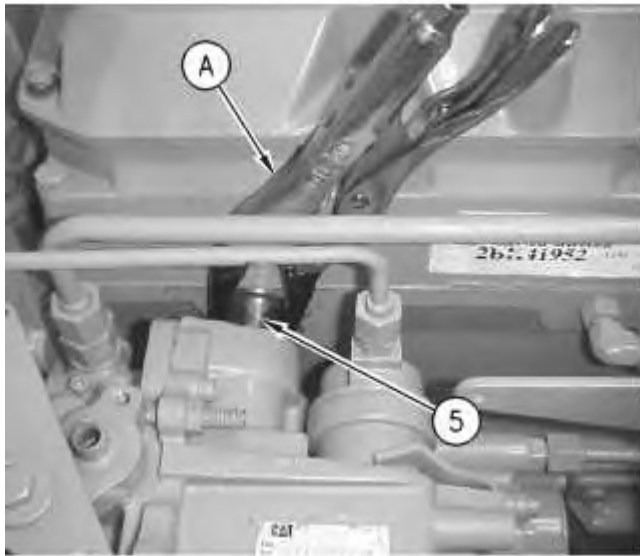

Illustration 3

g00655975

4. Use Tooling (A) to slide tube assembly (5) into the cylinder head.

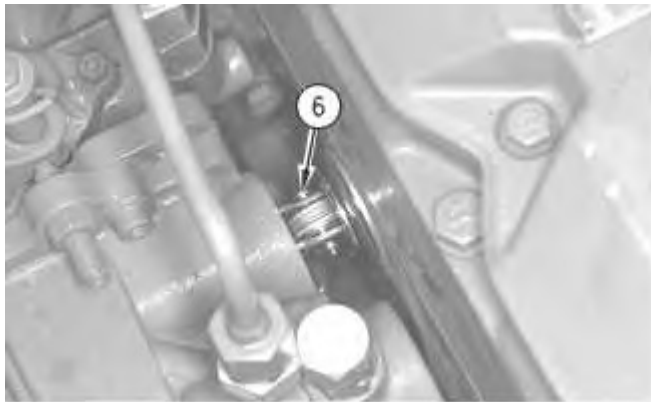

Illustration 4

g00613149

5. Remove the clip and use Tooling (A) to remove the clevis pin (6).

Note: Clevis pin (6) must stay with the governor in order to be adjusted.

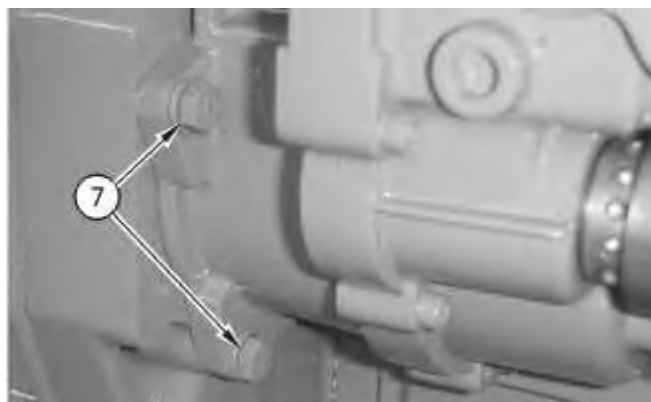

Illustration 5

g00613563

6. Remove bolts (7) and the washers that hold the governor in position.



Illustration 6

g00673182

7. Remove the governor from the engine.

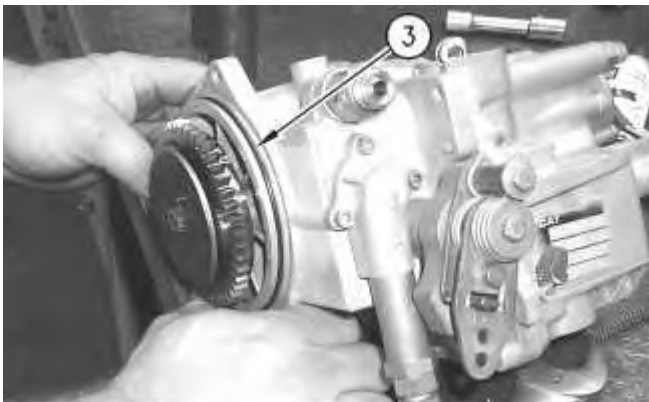

Illustration 7

g00673180

8. Remove O-ring seal (3) on the governor.

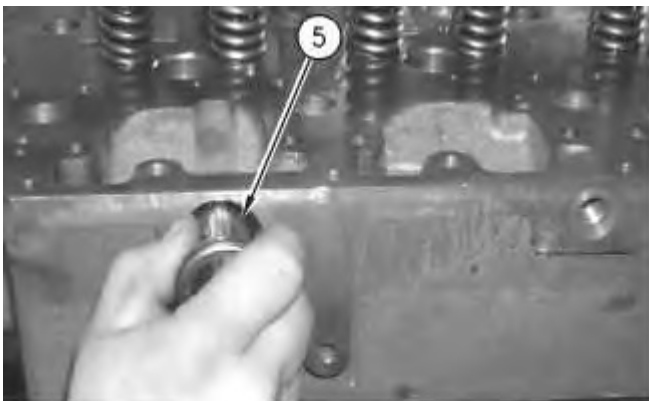

Illustration 8

g00672742

9. Remove the O-ring seal and tube assembly (5) from the cylinder head.

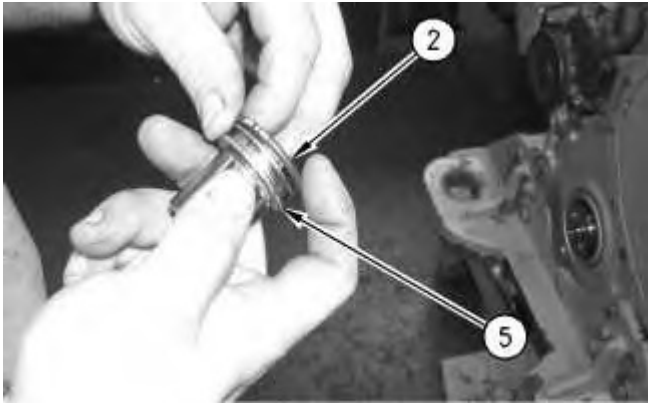

Illustration 9

g00672733

10. Remove O-ring seal (2) on the tube assembly (5).

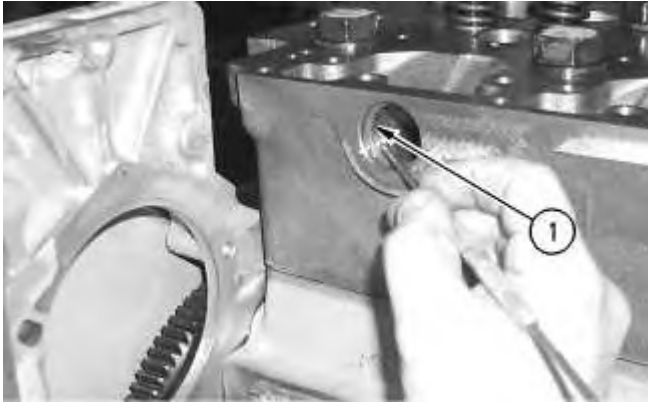

Illustration 10

g00673178

11. Remove O-ring seal (1) from the cylinder head.

Note: For more information on the governor, refer to Service Manual, SENR6454, "3114, 3116, & 3126 Engine Governors". The Service Manual, SENR6454 requires the use of a **1U-7326** Governor Calibration Bench. For information on reusability of components in the governor, refer to Guideline For Reusable Parts And Salvage Operations, SEBF8434, "3100 Governor Inspection and General Information for Mechanical Governor Groups Used in 3114, 3116, and 3126 Engines Equipped with Mechanical Unit Injectors (MUI)".

[Previous Screen](#)

Product: EXCAVATOR

Model: 322 LN EXCAVATOR 4RM

Configuration: 322 L, 322 LN AND 322 N EXCAVATORS 4RM00001-UP (MACHINE) POWERED BY 3116 ENGINE

Disassembly and Assembly

446 and 446B Backhoe Loaders, Lexion 450 Combine, 3114 and 3116 Engines, IT18F Integrated Toolcarrier, D6M Track-Type Tractor and 928F, 950F and 950G Wheel Loaders

Media Number -SEN3611-18

Publication Date -01/05/2009

Date Updated -27/05/2009

i01928419

Governor - Install

SMCS - 1264-012

Installation Procedure

Table 1

Required Tools			
Tool	Part Number	Part Description	Qty
A	136-4149	Governor Pliers ⁽¹⁾	1
B	128-8827	Pin ⁽¹⁾	1
	1U-7523	Pin Pilot ⁽¹⁾	1

⁽¹⁾ This tool is part of the **128-8822** Governor Tool Group.

NOTICE

Keep all parts clean from contaminants.

Contaminants may cause rapid wear and shortened component life.

Note: For more information on the governor, refer to Service Manual, SENR6454, "3114, 3116, & 3126 Engine Governors". The Service Manual, SENR6454 requires the use of a **1U-7326** Governor Calibration Bench. For information on reusability of components in the governor, refer to Guideline For Reusable Parts And Salvage Operations, SEBF8434, "3100 Governor Inspection and General Information for Mechanical Governor Groups Used in 3114, 3116, and 3126 Engines Equipped with Mechanical Unit Injectors (MUI)".



Illustration 1

g00673178

1. Apply lubricant to the new O-ring seal (1). Install new O-ring seal (1) in the cylinder head.

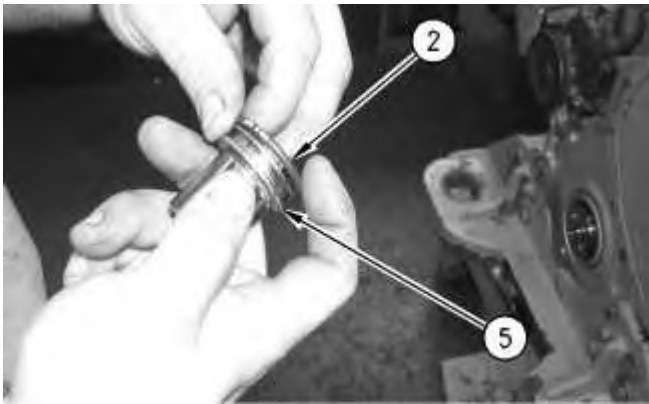

Illustration 2

g00672733

2. Apply lubricant to the new O-ring seal (2). Install new O-ring seal (2) on the tube assembly (5).

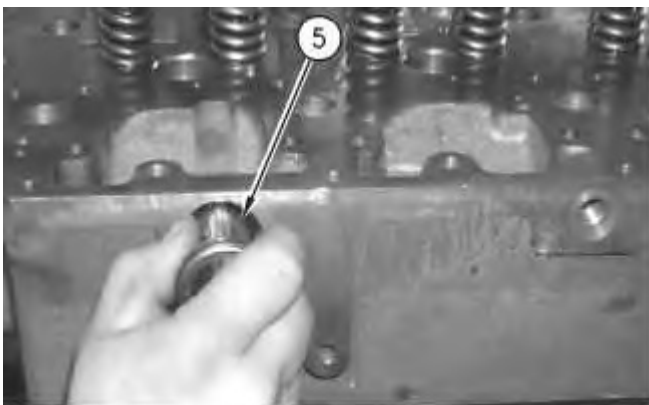

Illustration 3

g00672742

3. Install the O-ring seal and tube assembly (5) in the cylinder head.
-

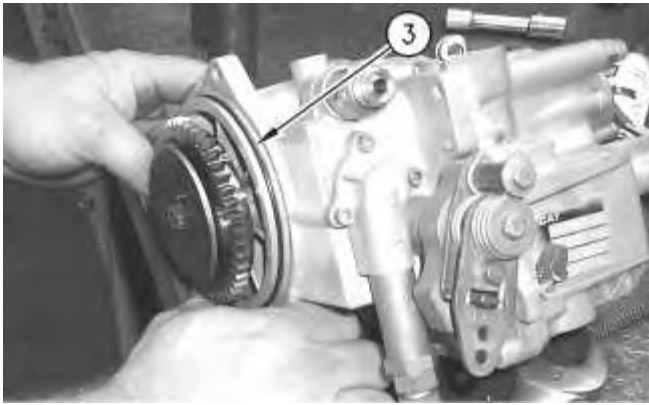

Illustration 4

g00673180

4. Apply lubricant to the new O-ring seal (3). Install new O-ring seal (3) on the governor.



Illustration 5

g00673182

5. Place the governor in position on the engine.

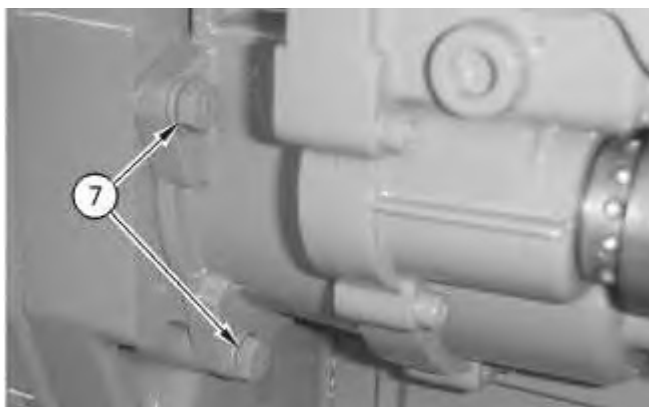

Illustration 6

g00613563

6. Install the washers and bolts (7) that hold the governor in place.

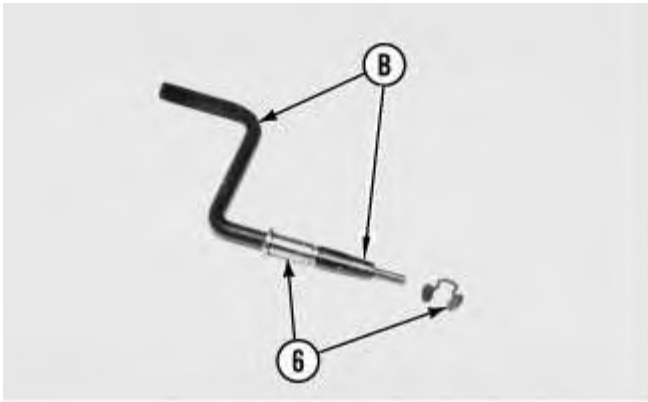

Illustration 7

g00672755

7. Install clevis pin (6) in Tooling (B).

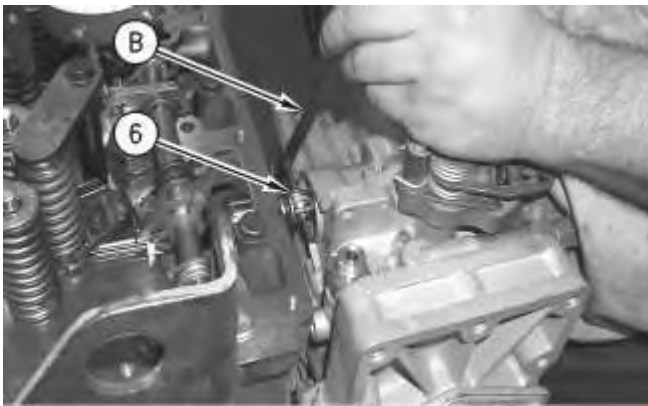
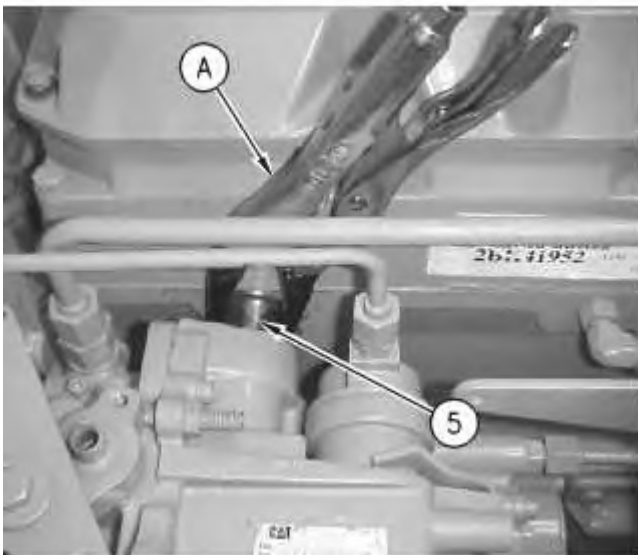

Illustration 8

g00672752

8. Use Tooling (B) to install clevis pin (6) and the clip.
9. Check the fuel setting adjustment. Refer to Testing and Adjusting, SENR5118.



10. Use Tooling (A) to slide tube assembly (5) into the governor.



Illustration 10

g00613071

11. Install clip (4).

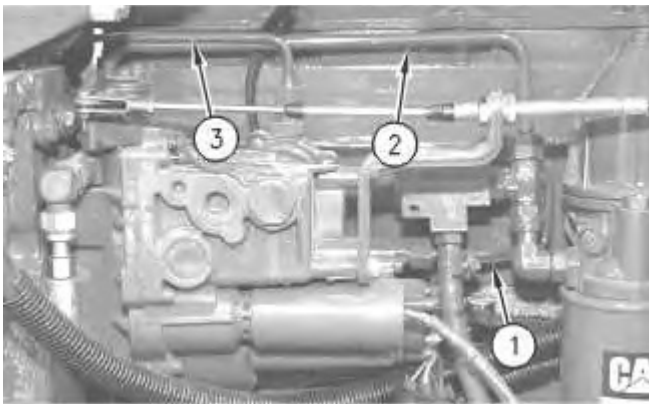

Illustration 11

g00613041

12. Install oil tube assembly (1). Install tube assembly (2) and tube assembly for fuel ratio control (3), if equipped. Plug and cap all connections.
13. Install the governor control cable.

End By:

- a. Install the fuel shutoff solenoid. Refer to Disassembly and Assembly, "Fuel Shutoff Solenoid - Remove and Install".

[Previous Screen](#)

Product: EXCAVATOR

Model: 322 LN EXCAVATOR 4RM

Configuration: 322 L, 322 LN AND 322 N EXCAVATORS 4RM00001-UP (MACHINE) POWERED BY 3116 ENGINE

Disassembly and Assembly

446 and 446B Backhoe Loaders, Lexion 450 Combine, 3114 and 3116 Engines, IT18F Integrated Toolcarrier, D6M Track-Type Tractor and 928F, 950F and 950G Wheel Loaders

Media Number -SEN3611-18

Publication Date -01/05/2009

Date Updated -27/05/2009

i01928445

Fuel Injection Control Linkage - Remove

SMCS - 1298-011

Removal Procedure

Table 1

Required Tools			
Tool	Part Number	Part Description	Qty
A	136-4149	Governor Pliers	1

Start By:

- a. Remove the rocker shaft and the pushrods. Refer to Disassembly and Assembly, "Rocker Shaft and Pushrod - Remove".

NOTICE

Keep all parts clean from contaminants.

Contaminants may cause rapid wear and shortened component life.



Illustration 1

g00613071

1. Remove clip (4). Clip (4) is located between the governor and the cylinder head.

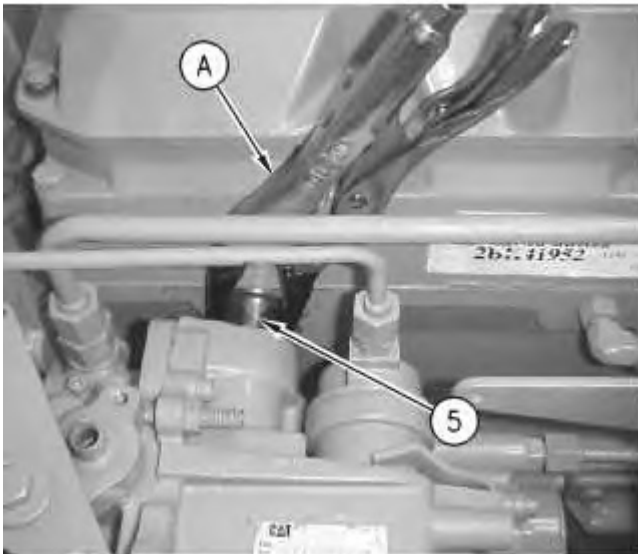

Illustration 2

g00655975

2. Use Tooling (A) to slide tube assembly (5) into the cylinder head.

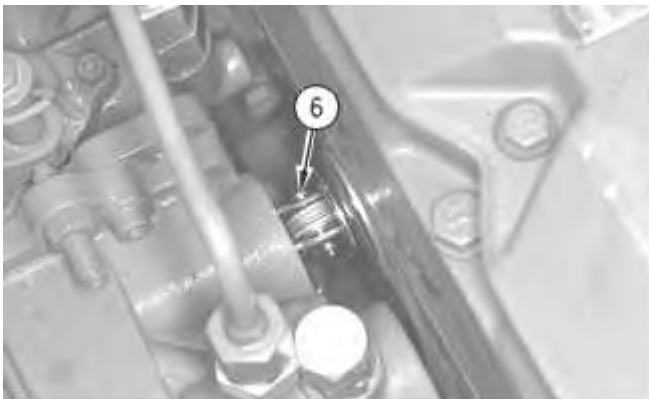

Illustration 3

g00613149

3. Remove the clip and use Tooling (A) to remove the clevis pin (6). Clevis pin (6) connects the governor to the control lever of the fuel injection control linkage.

Note: Clevis pin (6) must stay with the governor in order to be adjusted.

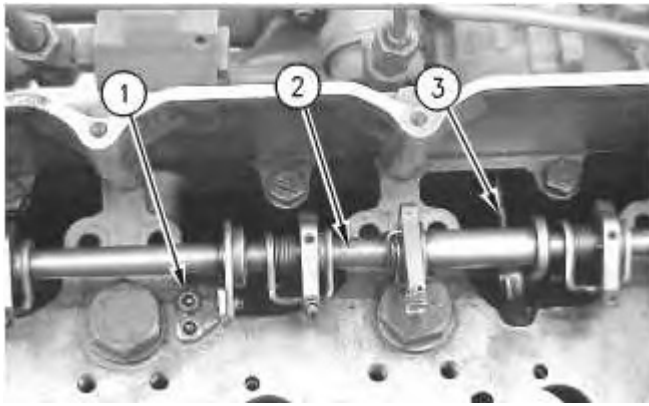

Illustration 4

g00630566

4. Remove bolts (1) and remove fuel injection control linkage (2). Control lever (3) connects the fuel injection control linkage (2) to the governor.

Note: For information on the inspection procedure for control lever (3), refer to Special Instruction, REHS0601, "Inspection and Modification of the 102-7459 Fuel Injection Control Linkage and the 4P-9048 Fuel Injection Control Linkage".

Previous Screen

Product: EXCAVATOR

Model: 322 LN EXCAVATOR 4RM

Configuration: 322 L, 322 LN AND 322 N EXCAVATORS 4RM00001-UP (MACHINE) POWERED BY 3116 ENGINE

Disassembly and Assembly

446 and 446B Backhoe Loaders, Lexion 450 Combine, 3114 and 3116 Engines, IT18F Integrated Toolcarrier, D6M Track-Type Tractor and 928F, 950F and 950G Wheel Loaders

Media Number -SEN3611-18

Publication Date -01/05/2009

Date Updated -27/05/2009

i01928573

Fuel Injection Control Linkage - Install

SMCS - 1298-012

Installation Procedure

Table 1

Required Tools			
Tool	Part Number	Part Description	Qty
A	136-4149	Governor Pliers ⁽¹⁾	1
B	128-8827	Pin ⁽¹⁾	1
	1U-7523	Pin Pilot ⁽¹⁾	1
C	1U-6675	Spring Compressor ⁽¹⁾	6
D	128-8822	Fuel System and Governor Tool Gp	1

⁽¹⁾ This tool is part of the 128-8822 Governor Tool Group.

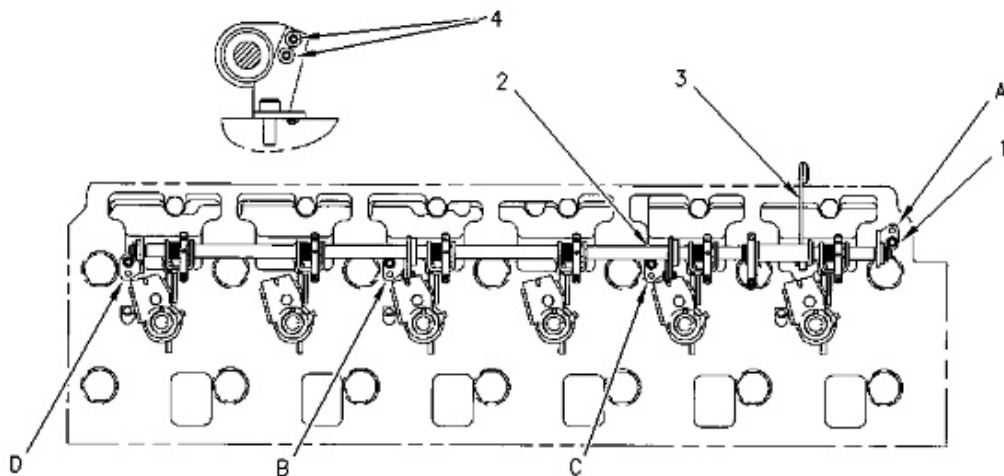

Note: For information on the inspection procedure for control lever (3), refer to Special Instruction, REHS0601, "Inspection and Modification of the 102-7459 Fuel Injection Control Linkage and the 4P-9048 Fuel Injection Control Linkage".

1. Loosen setscrews (4) on each bracket.
2. Install fuel control linkage (2) and install bolts (1). Use the following sequence in order to tighten the bolts.
3. Tighten bracket (A) and (D) to a torque of 12 ± 3 N·m (106 ± 27 lb in).
4. Tighten brackets (B) and (C) to a torque of 12 ± 3 N·m (106 ± 27 lb in).
5. Position brackets (B) and (C) in order to allow free rotation of the fuel control rod.
6. Use a 2.5 mm (0.10 inch) wrench to tighten setscrews (4). Tighten the setscrews to a torque of 3.5 ± 0.2 N·m (31 ± 2 lb in). Do not overtighten the setscrews. Ensure that the control rod rotates freely.
7. The control rod should rotate freely when a force of 4.4 N (1 lb) or less is applied to control lever (3).

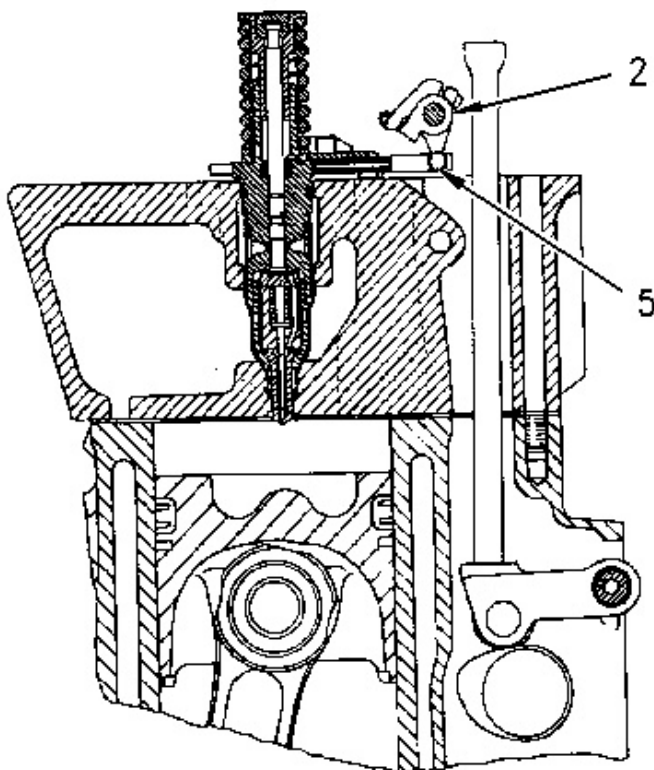

Illustration 2

g00750163

8. Rotate the unit injectors in order to engage the injector rack bar (5) with the fuel injection control linkage (2).

Note: If the unit injectors are not installed, refer to the Disassembly and Assembly, "Unit Injector - Install".

9. Install Tooling (C) on the unit injectors and compress the springs.

Note: For the procedure to install Tooling (C), refer to Tool Operating Manual, NEHS0610, "Using the 128-8822 Tool Group on 3114, 3116, and 3126 Engines with Mechanical Unit Injectors (MUI)".

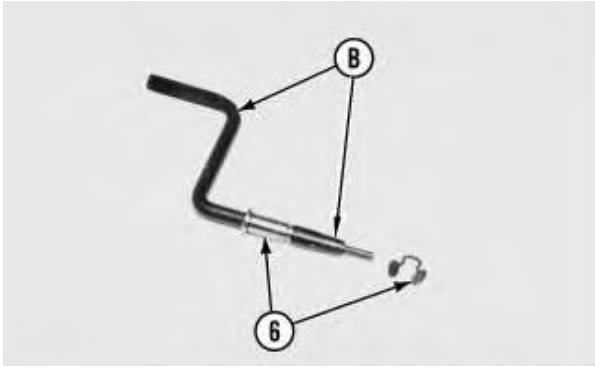

Illustration 3

g00672755

10. Install clevis pin (6) in Tooling (B). Clevis pin (6) attaches the control lever (3) to the governor.

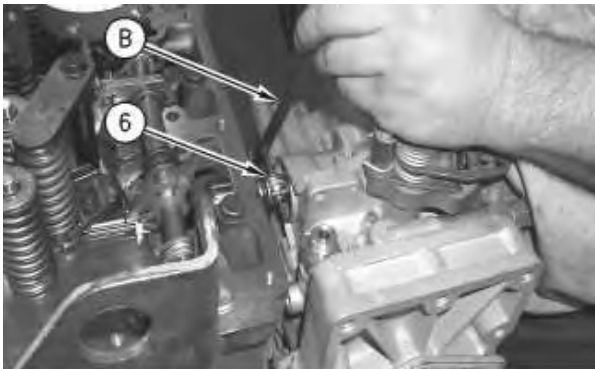

Illustration 4

g00672752

11. Use Tooling (B) to install clevis pin (6) and the clip.
12. Use Tooling (D) to set the unit injector synchronization.

Note: For the procedure to use Tooling (D), refer to Tool Operating Manual, NEHS0610, "Using the 128-8822 Tool Group on 3114, 3116, and 3126 Engines with Mechanical Unit Injectors (MUI)".

13. Remove Tooling (C) from the unit injectors.
-

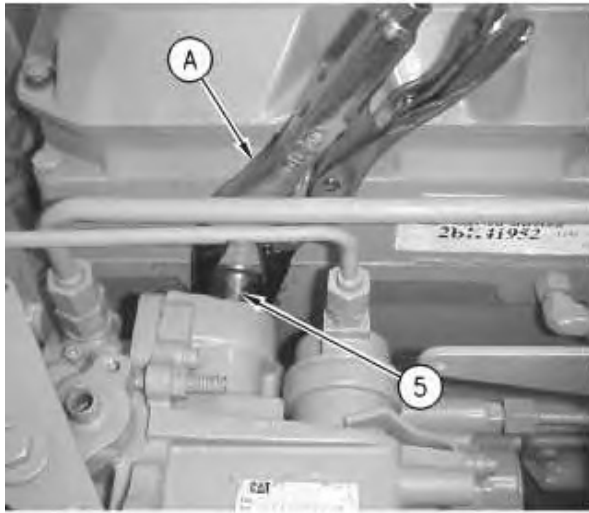

Illustration 5

g00655975

14. Use Tooling (A) to slide tube assembly (5) into the governor.



Illustration 6

g00613071

15. Install clip (4).

End By:

- a. Install the rocker arm assemblies and the pushrods. Refer to Disassembly and Assembly, "Rocker Shaft and Pushrod - Install".

[Previous Screen](#)

Product: EXCAVATOR

Model: 322 LN EXCAVATOR 4RM

Configuration: 322 L, 322 LN AND 322 N EXCAVATORS 4RM00001-UP (MACHINE) POWERED BY 3116 ENGINE

Disassembly and Assembly

446 and 446B Backhoe Loaders, Lexion 450 Combine, 3114 and 3116 Engines, IT18F Integrated Toolcarrier, D6M Track-Type Tractor and 928F, 950F and 950G Wheel Loaders

Media Number -SEN3611-18

Publication Date -01/05/2009

Date Updated -27/05/2009

i05919358

Unit Injector - Remove

SMCS - 1290-011

Removal Procedure

Table 1

Required Tools			
Tool	Part Number	Part Description	Qty
A	5P-0302	Bar	1

Start By:

- A. Remove the rocker shaft and the pushrods. Refer to Disassembly and Assembly, "Rocker Shaft and Pushrod - Remove".

NOTICE

Keep all parts clean from contaminants.

Contaminants may cause rapid wear and shortened component life.

NOTICE

Care must be taken to ensure that fluids are contained during performance of inspection, maintenance, testing, adjusting, and repair of the product. Be prepared to collect the fluid with suitable containers

before opening any compartment or disassembling any component containing fluids.

Refer to Special Publication, NENG2500, "Dealer Service Tool Catalog" for tools and supplies suitable to collect and contain fluids on Cat products.

Dispose of all fluids according to local regulations and mandates.

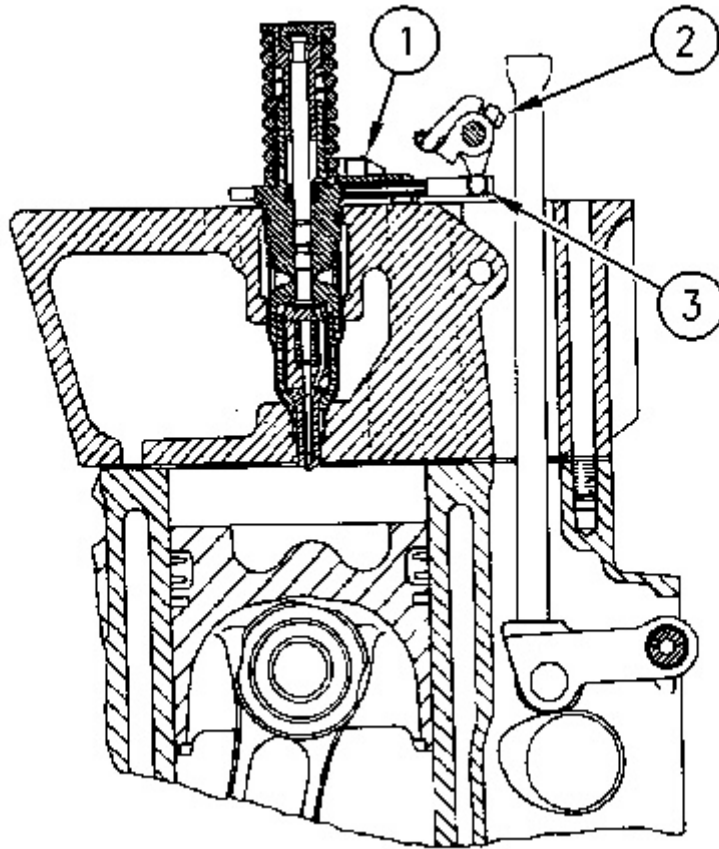

Illustration 1

g00775441



Suggest:

If the above button click is invalid.

Please download this document

first, and then click the above link

to download the complete manual.

Thank you so much for reading



Illustration 2

g00625237

1. Remove fuel injector hold-down bolt (1) .

Note: Do not pry on the injector hold-down bracket. Damage to the unit injector could occur. The unit injector has a notch on the opposite side of the rack. This notch is used for prying the unit injector loose. Some fuel injector racks move freely when the spring is not compressed. Do not move the fuel injector rack without compressing the fuel injector spring slightly. Damage may occur to the unit injector.

2. Use Tooling (A) to loosen the unit injector. Rotate the unit injector in order to disengage injector rack bar (3) from fuel injection control linkage (2) .
3. Remove the unit injector. Ensure that two O-ring seals are on the unit injector.

<https://www.ebooklibonline.com>

Hello dear friend!

Thank you very much for reading.

Enter the link into your browser.

The full manual is available for immediate download.

<https://www.ebooklibonline.com>