

T M

John Deere 690DR Excavator With All Terrain Wheeled Undercarriage

Deere & Company
Moline, Illinois
Contract DLA700-89-C-8012
Excavator Wheel Mounted
690D RRR
S/N (531676-)
T. O. No. 36C37-2-3-24

Deere & Co.
Moline, Illinois 61265
Contract: DLA 700-89-C-8012
Excavator, Wheel Mounted
Model 690DRRR
Serial Number _____
T.O. Number _____

TMT124557



690DR EXCAVATOR TECHNICAL MANUAL TMT124557

SECTION AND GROUP CONTENTS

SECTION I—GENERAL INFORMATION

- Group I—Introduction and Safety Information
- Group II—Specifications
- Group III—Torque Values
- Group IV—Fuel and Lubricants
- Group V—Predelivery and After-Sale Inspection

SECTION 01—WHEELS

- Group 0110—Power Wheels and Fastenings

SECTION 02—AXLES AND SUSPENSION SYSTEMS (PROPEL)

- Group 0250—Axle Shaft, Bearings, and
Reduction Gears
- Group 0260—Hydraulic System

SECTION 04—ENGINE

- Group 0400—Removal and Installation

SECTION 05—ENGINE AUXILIARY SYSTEM

- Group 0505—Cold Weather Starting Aid
- Group 0510—Cooling Systems
- Group 0515—Speed Controls
- Group 0520—Intake System
- Group 0530—External Exhaust Systems
- Group 0560—External Fuel Supply Systems

SECTION 07—DAMPENER DRIVE (FLEX COUPLING)

- Group 0752—Elements

SECTION 16—ELECTRICAL SYSTEMS

- Group 1671—Batteries, Support and Cables
- Group 1672—Alternator, Regulator, and
Charging System Wiring
- Group 1673—Lighting System
- Group 1674—Wiring Harnesses and Switches

All information, illustrations and specifications contained in this technical manual are based on the latest information available at the time of publication. The right is reserved to make changes at any time without notice.

Copyright © 1989
DEERE & COMPANY
Moline, Illinois
All rights reserved
A John Deere ILLUSTRATION® Manual

SECTION AND GROUP CONTENTS—Continued

SECTION 17—FRAME, CHASSIS, OR SUPPORTING STRUCTURE

- Group 1740—Frame Installation
- Group 1749—Chassis Weights

SECTION 18—OPERATOR'S STATION

- Group 1800—Removal and Installation
- Group 1810—Operator Enclosure
- Group 1821—Seat and Support
- Group 1830—Heating and Air Conditioning

SECTION 19—SHEET METAL AND STYLING

- Group 1910—Hood or Engine Enclosure

SECTION 32—DOZERS

- Group 3201—Blade
- Group 3240—Frames
- Group 3260—Dozer Hydraulics

SECTION 33—EXCAVATOR

- Group 3302—Buckets
- Group 3340—Frames
- Group 3360—Hydraulic System

SECTION 43—SWING ROTATION OR PIVOTING SYSTEM

- Group 4311—Brakes
- Group 4350—Mechanical Drive Elements
- Group 4360—Hydraulic System

SECTION 9005—OPERATIONAL CHECKOUT PROCEDURE

- Group 10—System Operational Checkout Procedure

SECTION 9010—ENGINE OPERATION AND TESTS

- Group 05—Theory of Operation
- Group 10—System Operational Checks
- Group 15—System Diagnostic Checks
- Group 20—Adjustments
- Group 25—Tests

SECTION 9015—ELECTRICAL SYSTEM OPERATION AND TESTS

- Group 00—Electrical System Operation and Tests

SECTION 9020—POWER TRAIN OPERATION AND TESTS

- Group 05—Theory of Operation
- Group 10—System Operational Checks
- Group 15—System Diagnostic Checks
- Group 20—Adjustments
- Group 25—Tests

SECTION 9025—HYDRAULIC SYSTEM OPERATION AND TESTS

- Group 05—Theory of Operation
- Group 10—System Operational Checks
- Group 15—System Diagnostic Checks
- Group 20—Adjustments
- Group 25—Tests

SECTION 99—DEALER FABRICATED TOOLS

- Group 9900—Fabricated Tools

<https://www.ebooklibonline.com>

Hello dear friend!

Thank you very much for reading.

Enter the link into your browser.

The full manual is available for immediate download.

<https://www.ebooklibonline.com>

INTRODUCTION

This manual is part of a total service support program.

FOS Manuals—reference

Technical Manuals—machine service

Component Manuals—component service

Fundamentals of Service (FOS) Manuals cover basic theory of operation, fundamentals of troubleshooting, general maintenance, and basic types of failures and their causes. FOS Manuals are for training new personnel and for reference by experienced technicians.

Technical Manuals are concise service guides for specific machines. Technical manuals are on-the-job guides containing only the vital information needed by an experienced service technician.

Component Technical Manuals are concise service guides for specific components. Component technical manuals are written as stand alone manuals covering multiple machine applications.

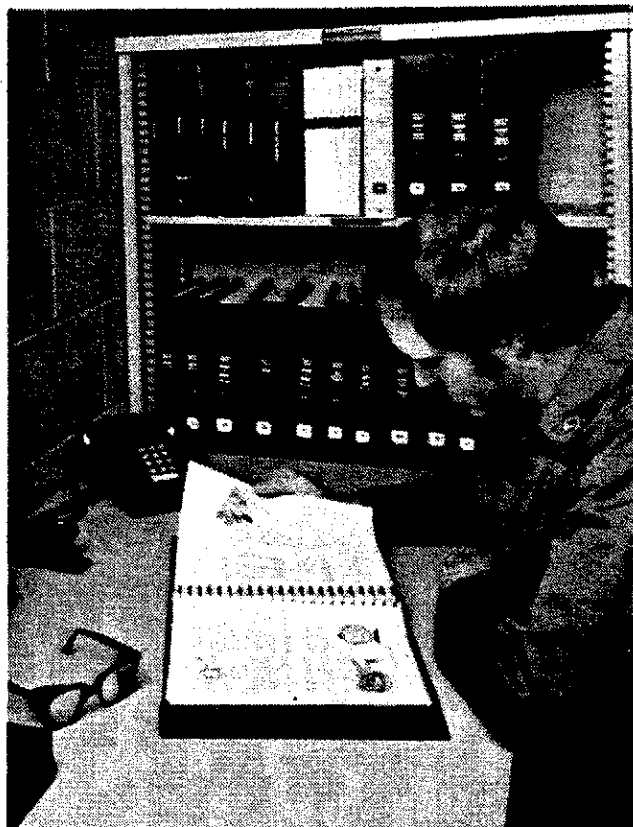

AB6;RW5559 053;INTRO2 030785

FEATURES OF THIS TECHNICAL MANUAL

John Deere ILLUSTRATION format emphasizing illustrations and concise instructions in easy-to-use modules.

Emphasis on diagnosis, analysis, and testing so you can understand the problem and correct it.

Diagnostic information presented with the most logical and easiest to isolate problems first to help you identify the majority of routine failures quickly.

Step-by-step instructions for teardown and assembly.

Summary listing at the beginning of each group of all applicable specifications, wear tolerances, torque values, essential tools, and materials needed to do the job.

An emphasis throughout on safety—so you do the job right without getting hurt.

This technical manual was planned and written for you—an experienced service technician. Keep it in a permanent binder in the shop where it is handy. Refer to it when you need to know correct service procedures or specifications.



AB6;RW5560 053;INTRO3 071085

THREE-STEP PROCEDURE

Use the following three-step procedure to locate the desired information.

1. Determine the type of information you need. Is it repair, operation, or tests?
2. Go to the appropriate section tab:

Gray for Repair
Yellow for Operation or Tests

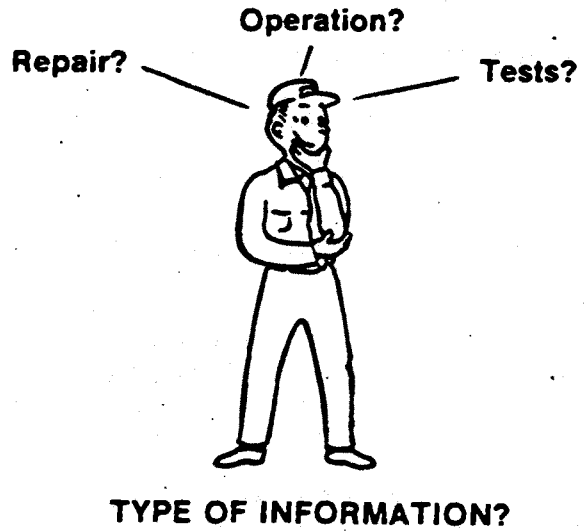

018;T5940AT T82;FLPD L 260785

3. Use the table of contents on the first page of the section to locate the information.

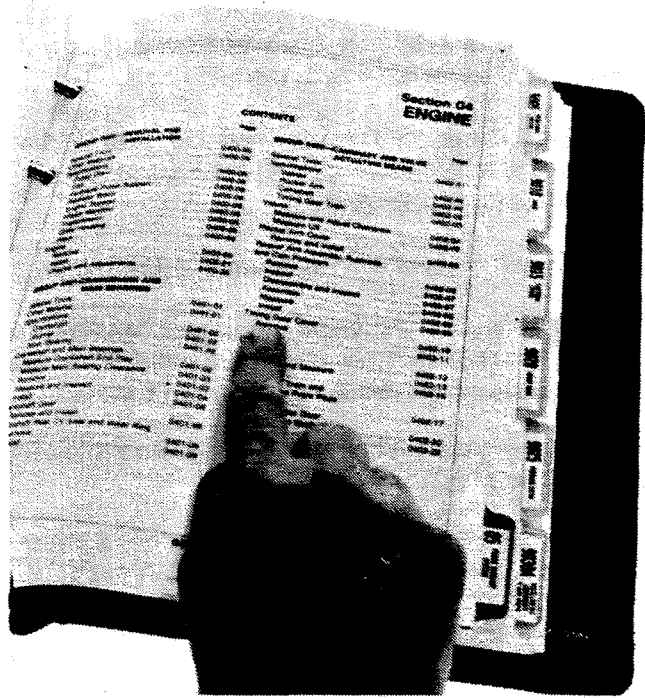

018;T5933AF T82;FLPD M 260785

SAFETY AND YOU

This safety-alert symbol means **ATTENTION! BECOME ALERT! YOUR SAFETY IS INVOLVED!**

When you see this symbol on your machine or in your manual, be alert to the possibility of personal injury. Follow the instructions in the safety message.



014781389 TR2:FLPD R 041104

RECOGNIZE SAFETY INFORMATION

This is the safety-alert symbol. When you see this symbol on your machine or in this manual, be alert to the potential for personal injury.

Follow recommended precautions and safe operating practices.

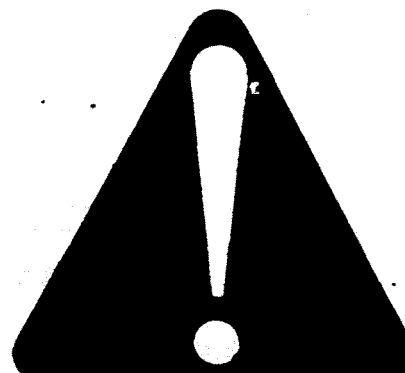

AB6;T81389 053;ALERT 160687

UNDERSTAND SIGNAL WORDS

A signal word—**DANGER**, **WARNING**, or **CAUTION**—is used with the safety-alert symbol. **DANGER** identifies the most serious hazards.

Safety signs with signal word **DANGER** or **WARNING** are typically near specific hazards.

General precautions are listed on **CAUTION** safety signs. **CAUTION** also calls attention to safety messages in this manual.



WARNING

CAUTION

AB6;TS187 053;SIGNAL 071085

FOLLOW SAFETY INSTRUCTIONS

Carefully read all safety messages in this manual and on your machine safety signs. Follow recommended precautions and safe operating practices.

Keep safety signs in good condition. Replace missing or damaged safety signs.

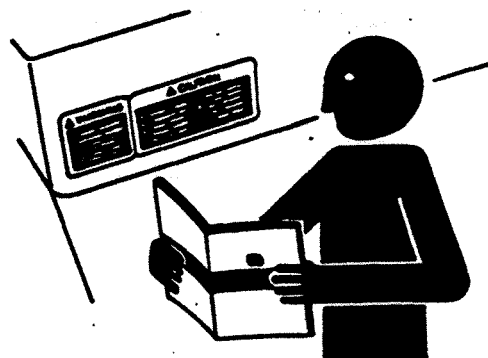

USE HANDHOLDS AND STEPS

When you get on and off machine, always maintain a three point contact with steps and handrails and face machine. Do not use any controls as handholds.

Never jump either on or off the machine. Never mount or dismount a moving machine.

Be careful of slippery conditions on platforms, steps, and handrails when mounting or dismounting.



018;T6192AH 027;05-FF4 010487

START ENGINE FROM OPERATOR'S SEAT

Avoid possible injury or machine damage. Do not start engine by shorting across starter terminals.

NEVER start engine while standing on ground. Start engine only from operator's seat.

T82;EXSA V 030487

AVOID POWER LINES

Serious injury or death can result from contact with electric lines.

Never move any part of the machine or load closer to electric line than 10 ft (3 m) plus twice the line insulator length. Use a signal person to guide operator. Use shrouds or insulators as necessary.

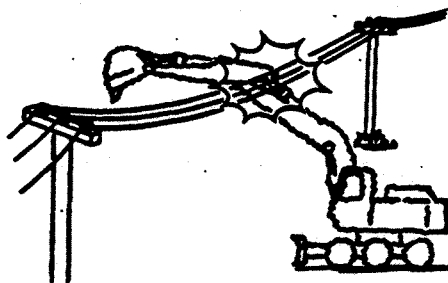

REMOVE PROPEL GEARBOX

CAUTION: The approximate weight of hardening panel is 214 kg (450 lb).

1. Remove six cap screws and washers to remove hardening panel from undercarriage.

CAUTION: The approximate weight of propel motor, counterbalance valve and brake is 134 kg (295 lb).

NOTE: It is not necessary to disconnect hydraulic lines from the drive train. The hoses are long enough to permit setting the drive train down on blocks a few inches off the ground.

2. Use a transmission jack or similar device to remove propel motor, counterbalance valve and brake.

3. Remove four cap screws and nuts (B) to remove propel motor and counterbalance assembly (A).

4. Remove brake (C).

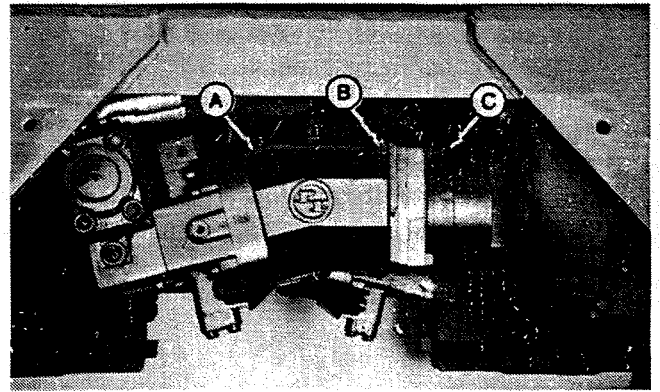

CAUTION: The approximate weight of wheel is 340 kg (750 lb.)

5. Remove center wheel.

NOTE: Repair procedures for left and right gearbox are similar. Right side shown.

6. Remove six cap screws and washers to remove center access plate (A) and gasket from wheelbox.

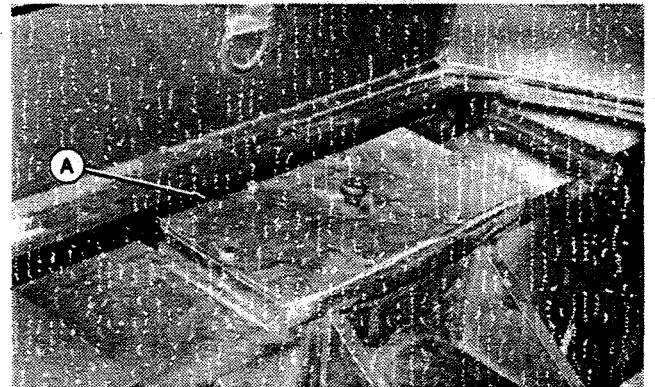

NOTE: Attaching long pieces of wire to both ends of chain will aid in installation.

7. Manually turn wheels until connecting link of short drive chain (gearbox sprocket to center axle sprocket chain) can be reached through access hole. Remove two cotter pins (A) to remove connecting link (B) from chain.

8. Disengage chain from gearbox sprocket.

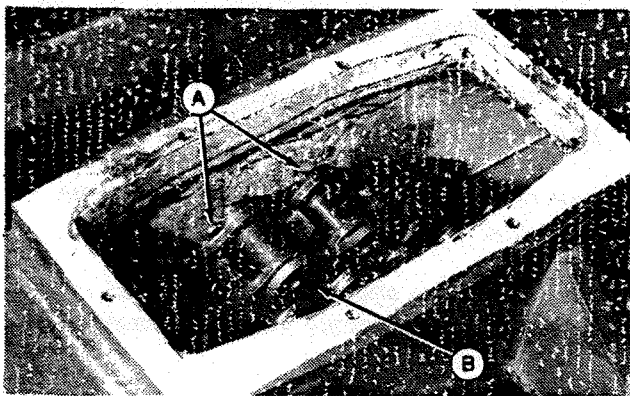

9. Remove panel (A).

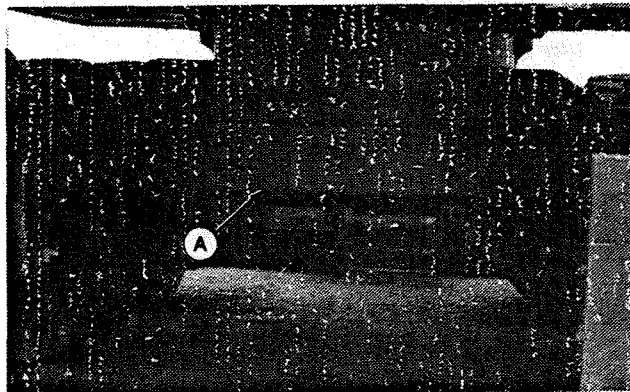

10. Remove six cap screws and washers, rear access panel and gasket from wheel box.

11. Manually rotate the rear wheel until the connecting link for the drive chain is accessible.

12. Remove two cotter pins to remove connecting link (A) from chain.

13. Disengage drive chain from gearbox sprocket.

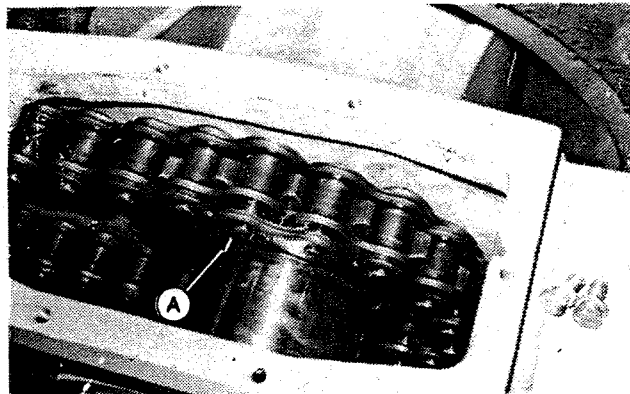

⚠ CAUTION: The approximate weight of propel gearbox is 125 kg (275 lb).

14. Remove eight cap screws (A) to remove gearbox (B).



0250.1 -19-21SEP89

T708-1MB -JUN-15SEP89

DISASSEMBLE PROPEL GEARBOX

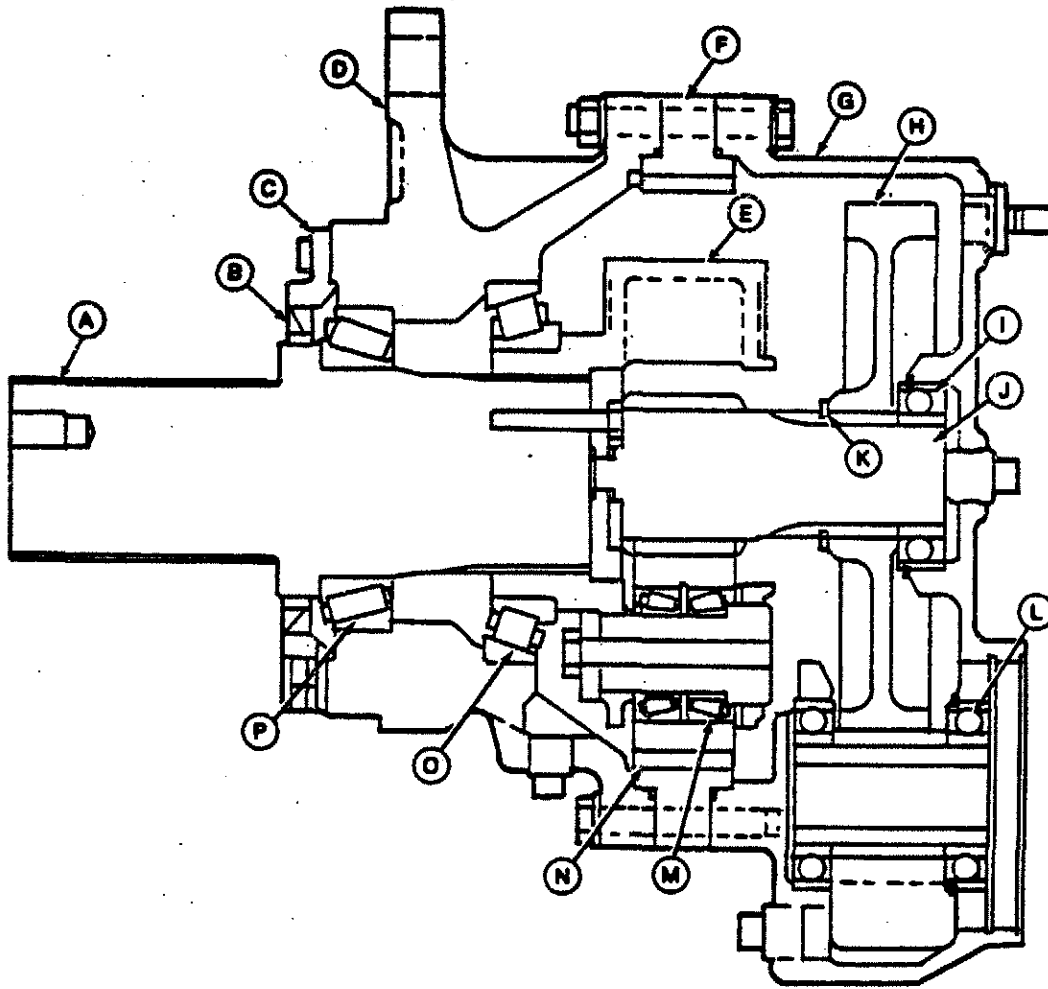

A—Output Shaft
 B—Seal
 C—Plate
 D—Output Housing

E—Planetary Carrier
 F—Ring Gear
 G—Input Housing
 H—Gear

I—Bearing
 J—Sun Gear
 K—Snap Ring
 L—Bearing

M—Bearing
 N—Planet Gear
 O—Bearing
 P—Bearing

T7134CJ JUN-1955EP80

0250.J -19-21SEP80

1. Remove parts (A—D).

A—Retainer Plate C—Output Shaft
B—Dual Drive Sprocket D—Gasket

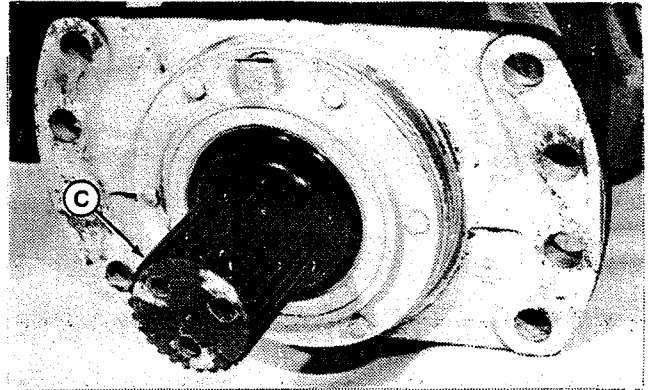
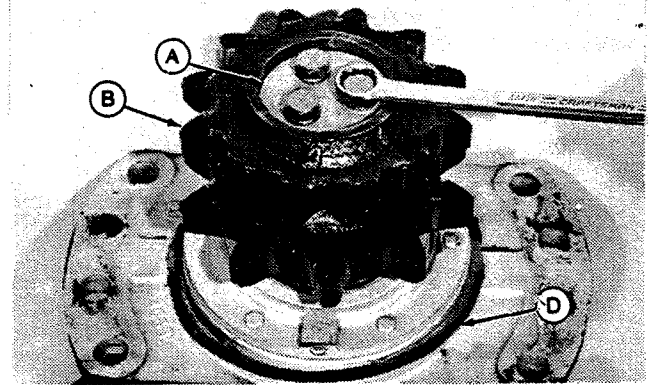

2. Remove snap ring.

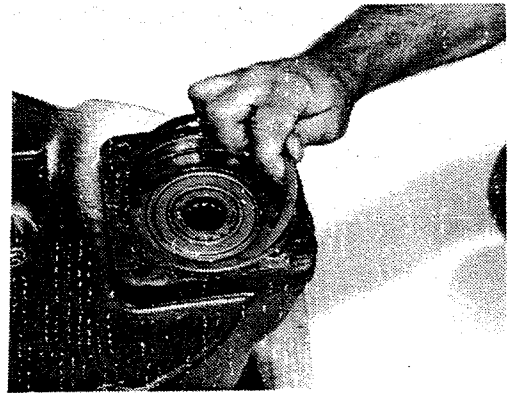

3. Remove bearing assembly.



4. Remove input shaft.

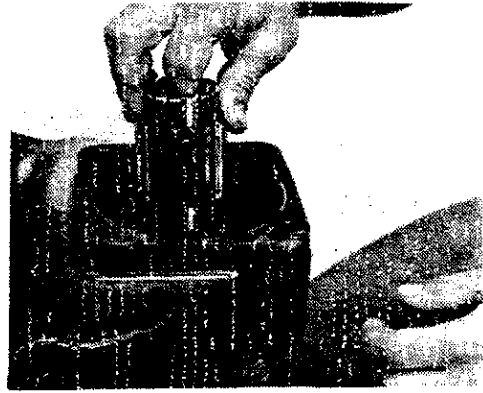

5. Remove snap ring (A).

6. Remove bearing (B).

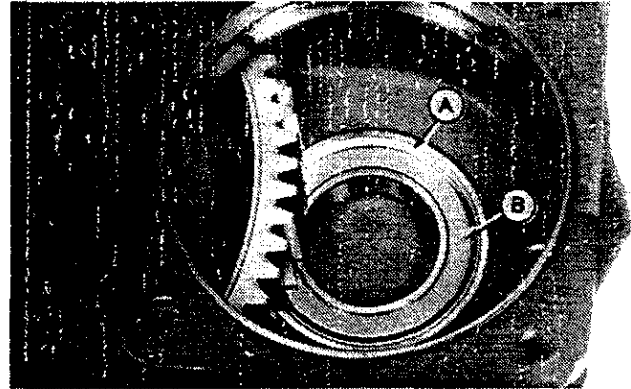

0250,0 -19-21SEP89

T7084MF -UN-15SEP89

7. Remove snap rings (A) and bearings (B) from the two input shaft spacers (C).

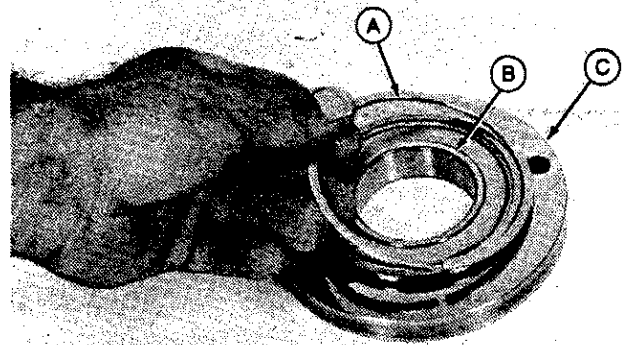

8. Remove cap screws and nuts (A). Remove nuts (B) from studs.

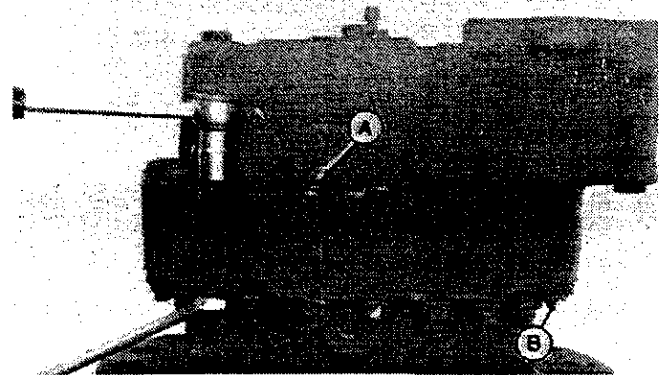

0250,0 -19-21SEP89

T7084MG -UN-15SEP89

9. Remove input housing (A).

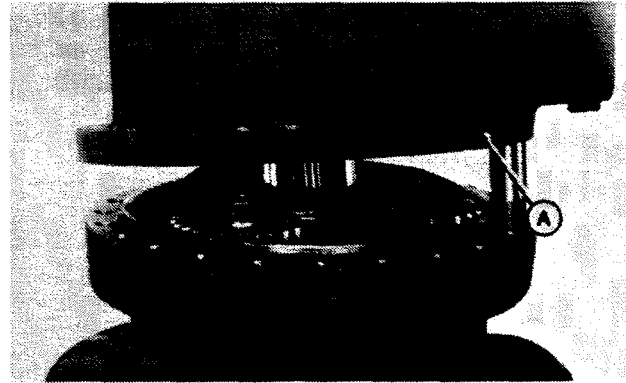

T7094MH -JUN-15SEP88

0250,R -18-21SEP89

10. Remove O-ring from ring gear.

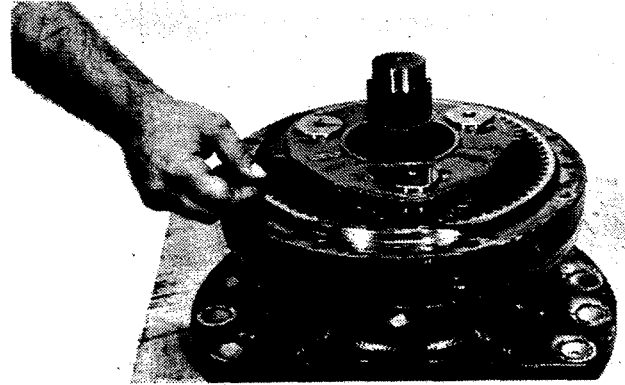

11. Remove sun gear.

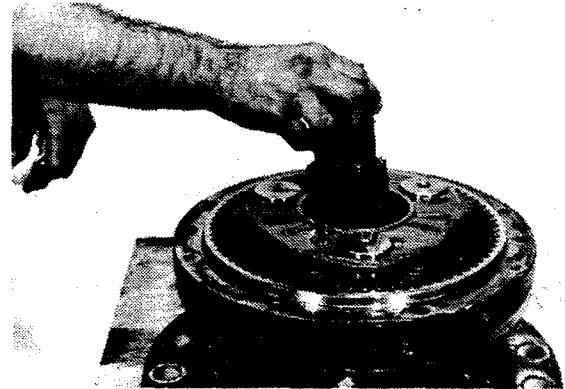

12. Remove snap ring (A) from sun gear.

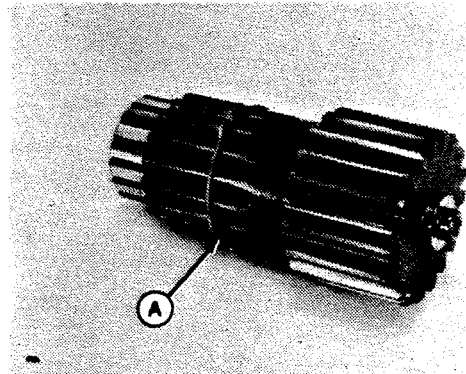

13. Remove six cap screws to remove planetary gear assembly (A), needle bearing (B) and thrust washer, and plate (C) and shims. Keep respective shim pack with plate.

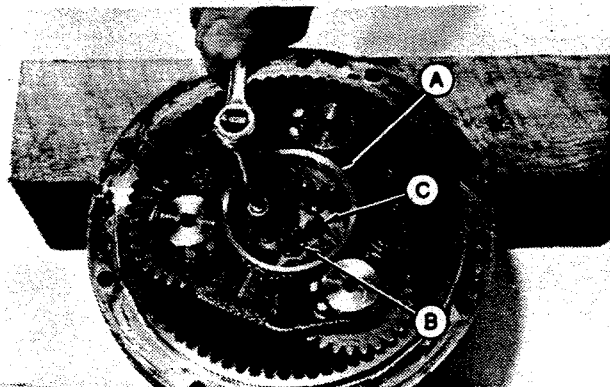

14. Remove tapered roller bearing from planetary gear assembly.

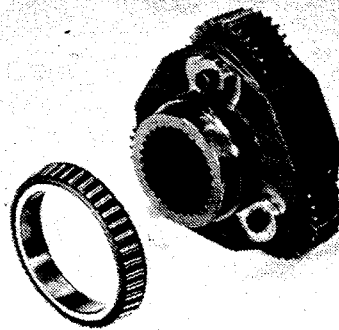

15. Remove parts (A—E).

16. Remove bearings (F) and snap rings (G) from each gear.

17. Repeat above two steps for each gear to disassemble planetary gear assembly (H).

18. Inspect parts for wear or damage and replace as necessary.

A—Cap Screw
B—Shaft
C—Special Washer
D—Spacer
E—Gear

F—Bearing (2 used)
G—Snap Ring (2 used)
H—Planetary Gear Assembly

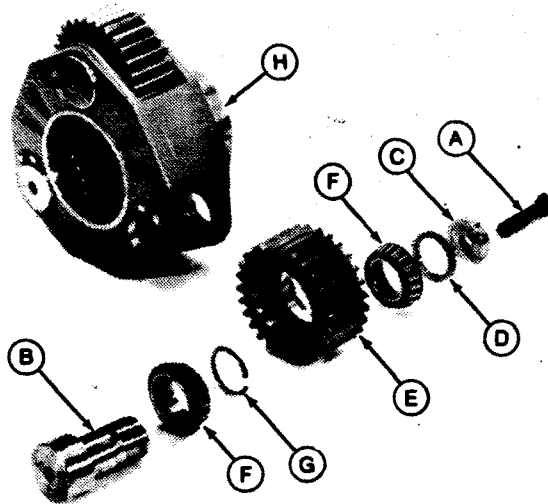

19. Remove six cap screws to remove retainer (A) and gasket from output housing.

20. Remove oil seal from retainer.

21. Remove output shaft assembly (B).

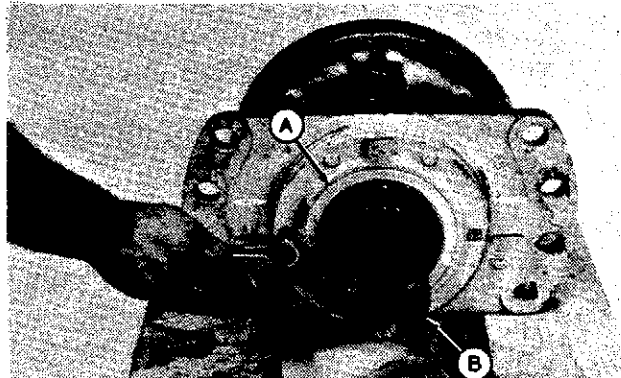

22. Remove bearing from output shaft.

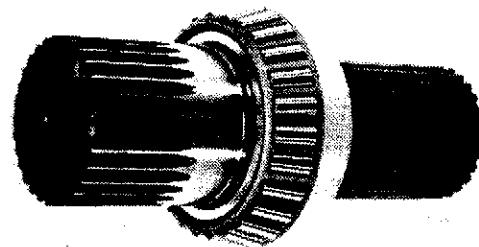

23. Remove bearing races (A) from output housing.

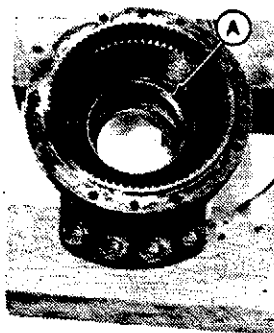
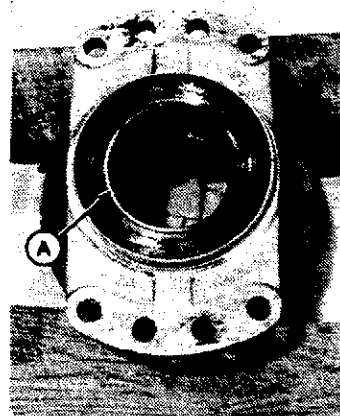

NOTE: Scribe reference marks across ring gear and output housing for reassembly.

24. Separate ring gear and housing being careful not to damage sealing surfaces.

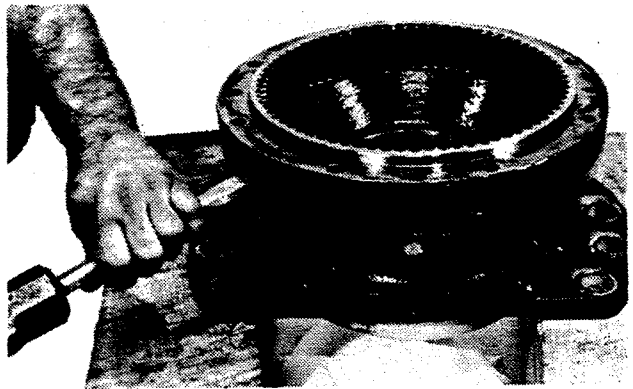

25. Remove large O-ring from output housing.

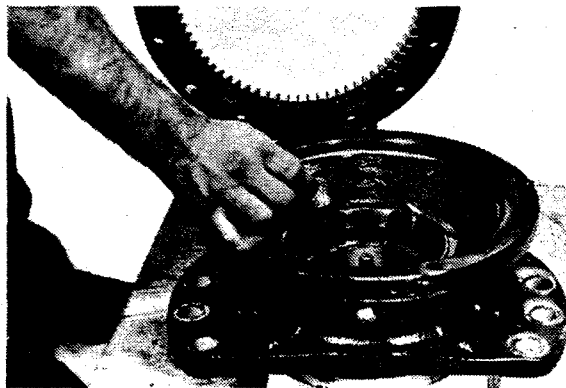

26. Slide large gear (A) out of input housing baffles.

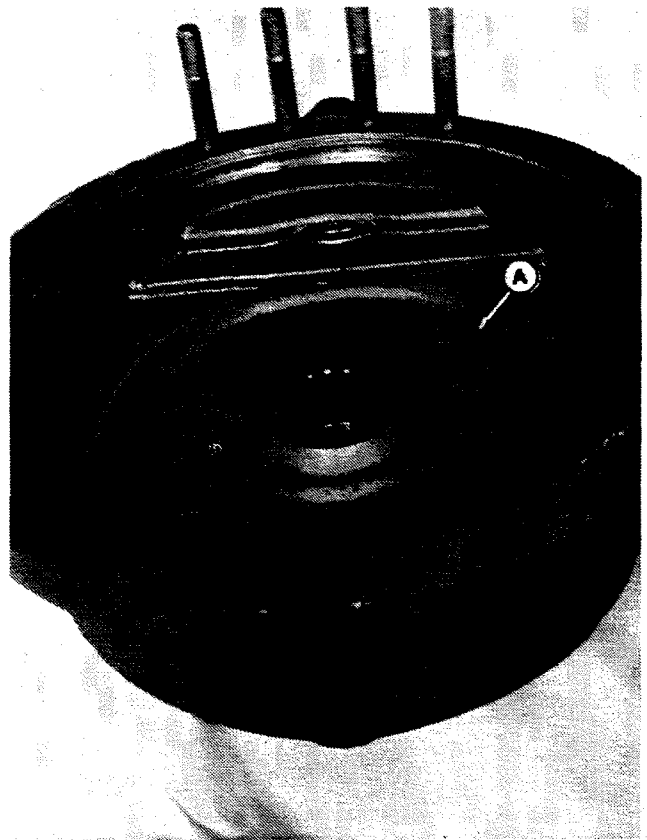

JUN-15SEP89
T708AMI

0250,AD -19-21SEP89

27. Remove bearing (A) from input housing.

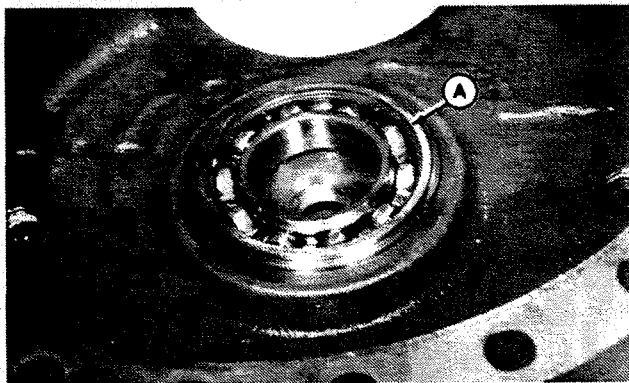

ASSEMBLE PROPEL GEARBOX

1. Install bearing (A) in input housing.

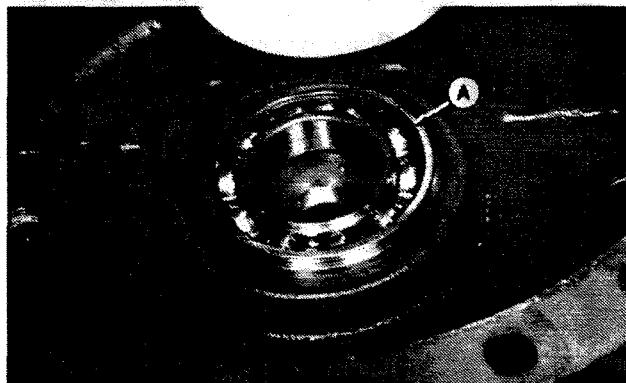

0250,AF -19-21SEP89

T7084M1 -JUN-15SEP88

2. Position large gear (A).

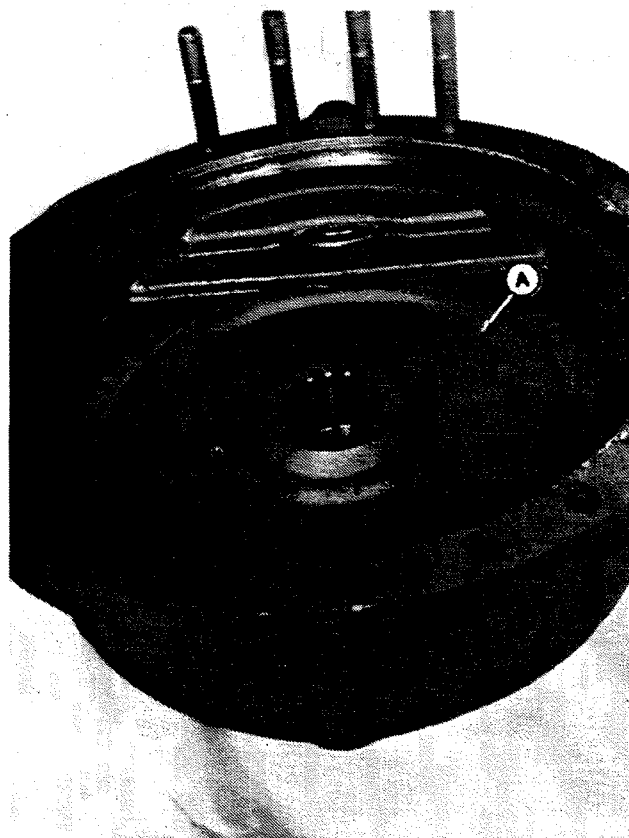

0250,AG -19-21SEP89

T7084M1 -JUN-15SEP88

3. Install large O-ring.

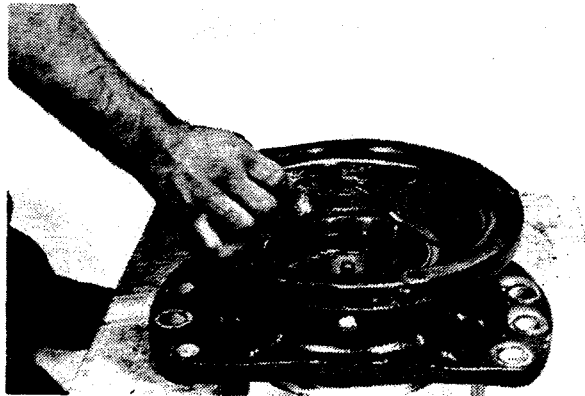

4. Position ring gear on output housing (aligning the reference marks made prior to disassembly).

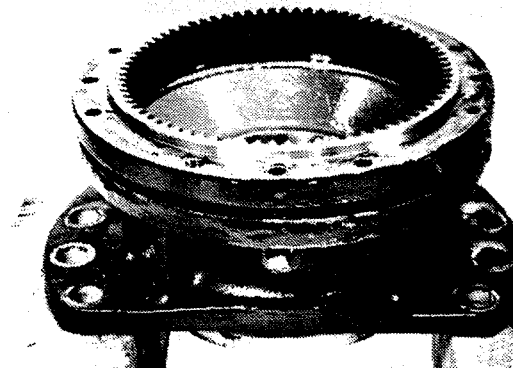

5. Install bearing races (A) in output housing.

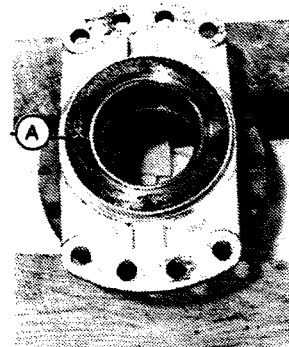
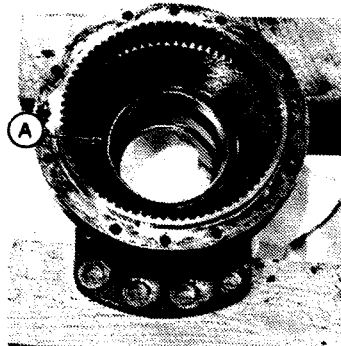

6. Install bearing on output shaft.

7. Install output shaft assembly in output housing.

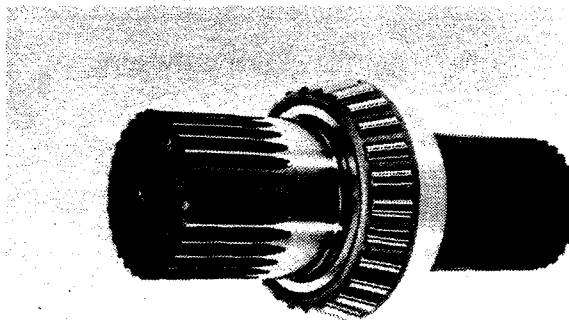

0250,AK -19-21SEP89

8. Install oil seal retainer (A).

9. Apply thread lock and sealer (low strength) to threads of cap screws. Install gasket, retainer (A) and cap screws. Tighten cap screws to 23 N-m (17 lb-ft).

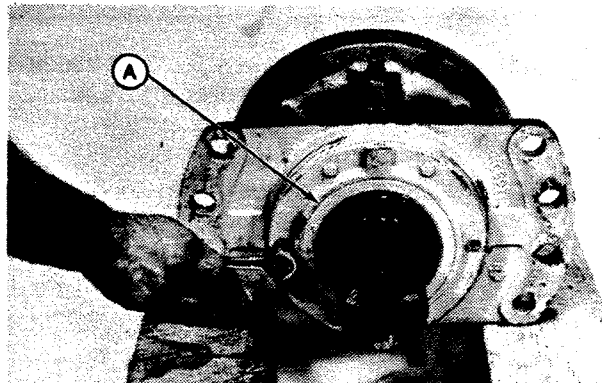

0250,AL -19-21SEP89

10. Install snap rings (A) and bearings (B) in gear (C).

11. Install gear (C), spacer (D), special washer (E), and shaft (F) in planetary gear housing (H). Apply thread lock and sealer (high strength) to threads of cap screw (G). Rotate gear while tightening cap screw to 163 N-m (120 lb-ft).

Measure thickness of planetary retaining plate (I) and install plate in housing before the last gear is installed. Repeat step 11 for remaining gears.

- | | |
|---------------------------|-----------------------------|
| A—Snap Ring (6 used) | F—Shaft (3 used) |
| B—Bearing (6 used) | G—Cap Screw (3 used) |
| C—Gear (3 used) | H—Planetary Gear Housing |
| D—Spacer (3 used) | I—Planetary Retaining Plate |
| E—Special Washer (3 used) | |

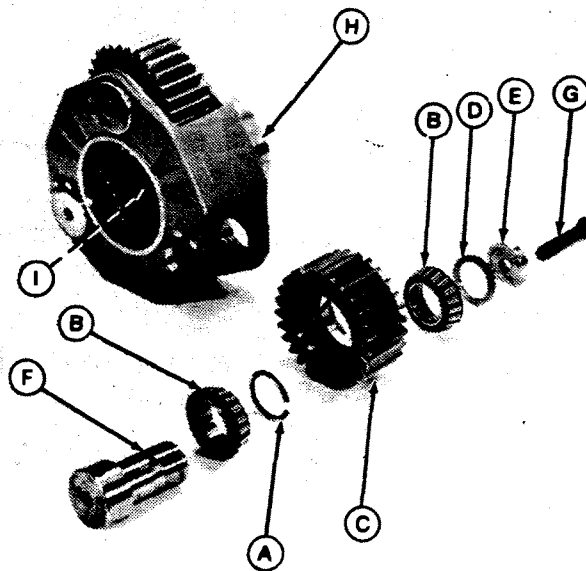

12. Install tapered roller bearing on planetary gear assembly.

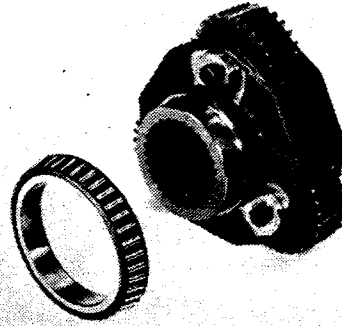

0250,AN -19-21SEP89

13. Install cap screws (A) and planetary gear assembly (B) in output housing. Rotate planetary gear assembly while tightening cap screws to 12 N·m (108 lb-in.).

14. Loosen cap screws and tighten again to 4 N·m (36 lb-in.).

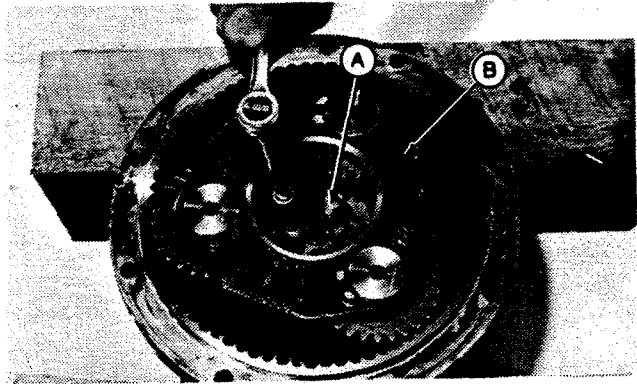

15. Measure depth from top of retaining plate (A) to top of output shaft (B) through holes in plate.

16. Subtract plate thickness from depth measured in Step 15. This is the gap between retaining plate and output shaft.

17. Put together a shim pack that is 0.05 mm (0.002 in.) less than calculated distance in Step 16. This will allow preload of 0.05 mm (0.002 in.) on bearings.

18. Remove planetary gear assembly. Install shim pack, planetary gear assembly, and cap screws. Apply thread lock and sealer (high strength) to threads of cap screws. Rotate planetary gear assembly while tightening cap screws to 108 N·m (80 lb-ft).

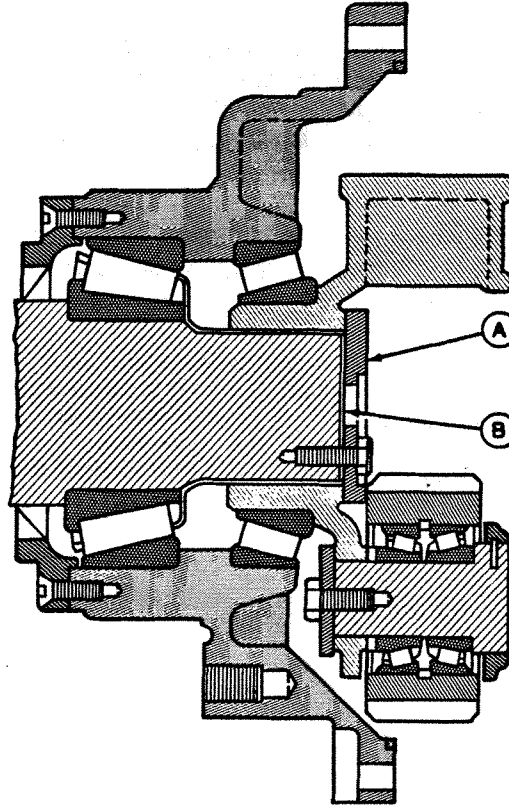

19. Install snap ring (A) on sun gear.

20. Install sun gear (B).

21. Install O-ring on ring gear.

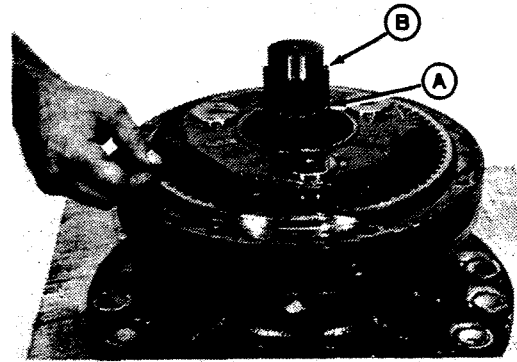

22. Install input housing on ring gear.

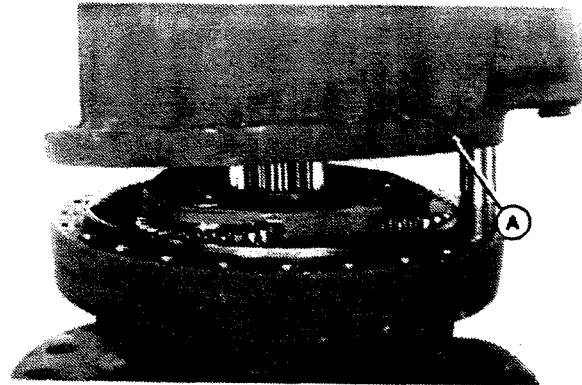

23. Apply thread lock and sealer (medium strength) to threads of cap screws (A) and studs (B).

24. Install cap screws and nuts.

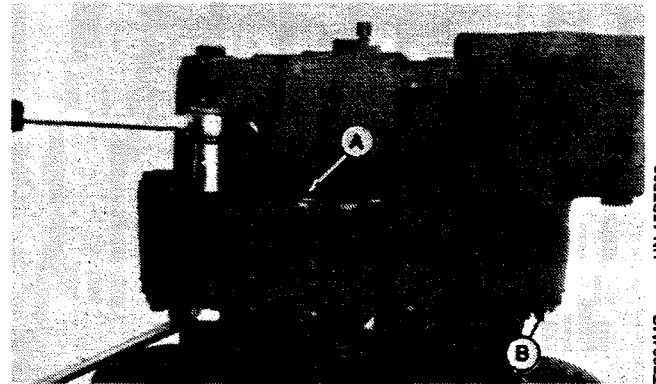

0250,AS -19-21SEP89

T7084MG -UN-15SEP88

25. Install bearings (A) and snap rings (B) in the input shaft spacers (C).





Suggest:

If the above button click is invalid.

Please download this document

first, and then click the above link

to download the complete manual.

Thank you so much for reading

26. Install bearing (B) and snap ring (A).

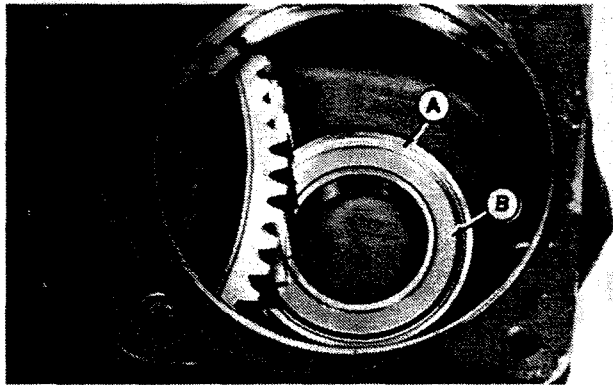

T7084MF -JUN-15SEP89

0250.AU -18-21SEP89

27. Install input shaft in input housing.

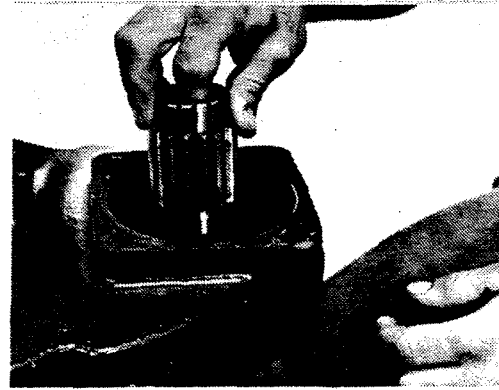

28. Install input bearing assembly.



29. Install snap ring.



<https://www.ebooklibonline.com>

Hello dear friend!

Thank you very much for reading.

Enter the link into your browser.

The full manual is available for immediate download.

<https://www.ebooklibonline.com>