



# Service Repair Manual

## **Models**

385C L Excavator

---

[Previous Screen](#)

Product: EXCAVATOR

Model: 385C L EXCAVATOR T2E

Configuration: 385C L Excavator T2E00001-UP (MACHINE) POWERED BY C-18 Engine

## Disassembly and Assembly

### 385C Excavator and 385C MHPU Mobile Hydraulic Power Unit Machine Systems

Media Number -REN8620-05

Publication Date -01/02/2012

Date Updated -20/02/2012

i02565371

## Final Drive - Disassemble

SMCS - 4050-015

## Disassembly Procedure

Table 1

Required Tools			
Tool	Part Number	Part Description	Qty
A	1P-2420	Transmission Repair Stand	1
B	138-7575	Link Bracket	3
C	138-7576	Link Bracket	2
D	132-8119	Hydraulic Wrench	1
	132-8223	Hydraulic Pump and Motor Gp	1
	9U-7418	Hex Bit Socket	1
E	176-6536	Forcing Bolt	2

### Start By:

- A. Remove the final drive. Refer to Disassembly and Assembly, "Final Drive - Remove".

**Note:** Cleanliness is an important factor. Before you begin the disassembly procedure, the exterior of the components should be thoroughly cleaned. This will help to prevent dirt from entering the internal mechanism. Precision components can be damaged by contaminants or by dirt. Perform disassembly procedures on a clean work surface. Keep components covered and protected at all times.

---

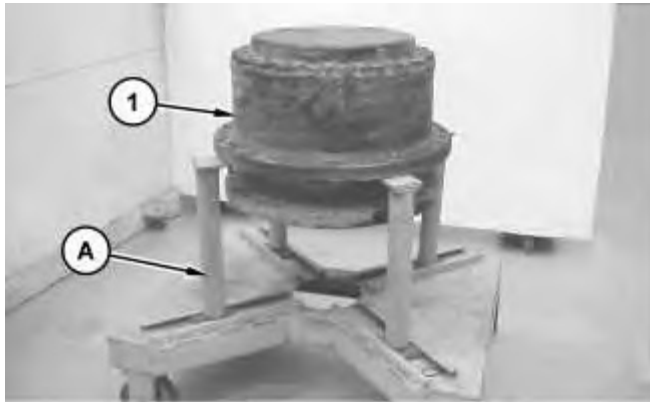

Illustration 1

g01284546

1. Fasten final drive (1) to Tooling (A). Put an alignment mark across the sections of final drive (1) for assembly purposes. All parts must be reinstalled in the original locations. The weight of final drive (1) is approximately 1020 kg (2250 lb).

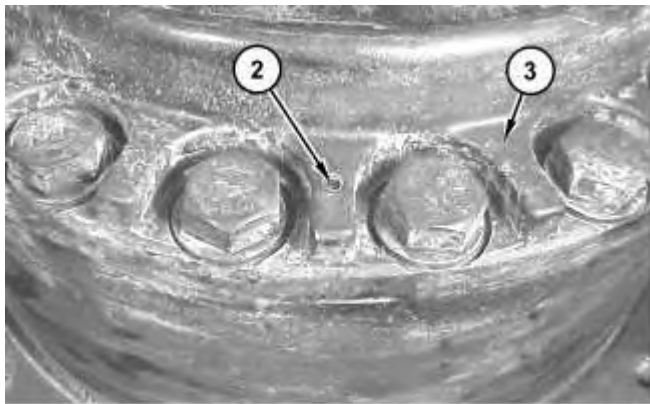

Illustration 2

g01284563

2. Remove socket setscrews (2) from housing cover (3) .



Illustration 3

g01284577

**<https://www.ebooklibonline.com>**

Hello dear friend!

Thank you very much for reading.

Enter the link into your browser.

The full manual is available for immediate download.

**<https://www.ebooklibonline.com>**

3. Fasten Tooling (B) and a suitable lifting device to housing cover (3) .
4. Remove bolts (4) and the washers. Use a soft faced hammer in order to break the seal between housing cover (3) and the ring gear. Remove housing cover (3). The weight of housing cover (3) is approximately 95 kg (210 lb).

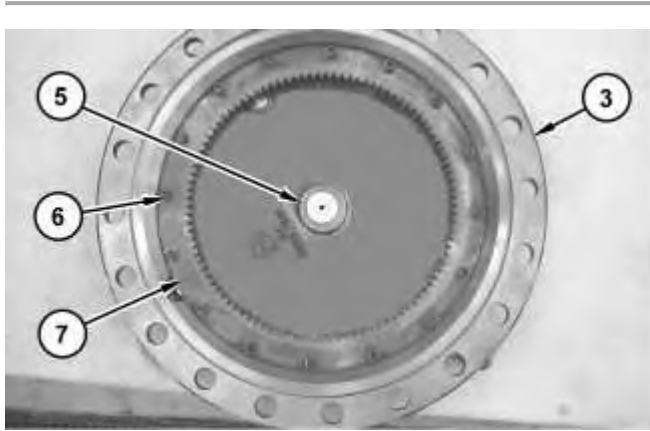

Illustration 4

g01284579

5. Remove spacer (5) and the shims from housing cover (3) .
6. Remove socket head bolts (6) and ring gear (7) from housing cover (3) .

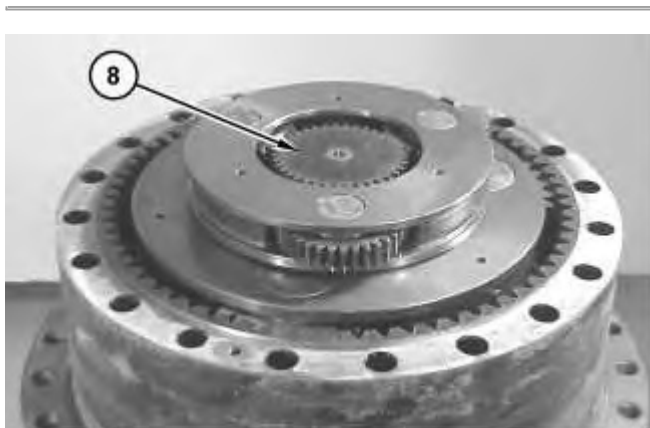

Illustration 5

g01284589

7. Remove sun gear (8) .
-



Illustration 6

g01284593

8. Use Tooling (B) and a suitable lifting device in order to remove carrier assembly (9). The weight of carrier assembly (9) is approximately 43 kg (95 lb).



Illustration 7

g01284596

9. Remove retaining ring (10), spacer (11), and sun gear (12) .

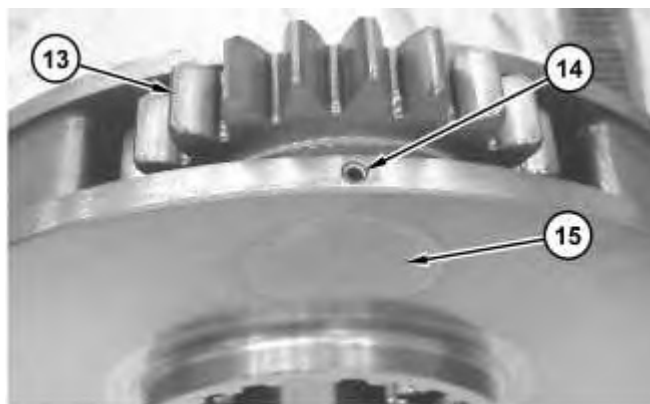

Illustration 8

g01284599

10. Drive spring pin (14) into planetary shaft (15). Remove planetary shaft (15) and planetary gear assembly (13) .

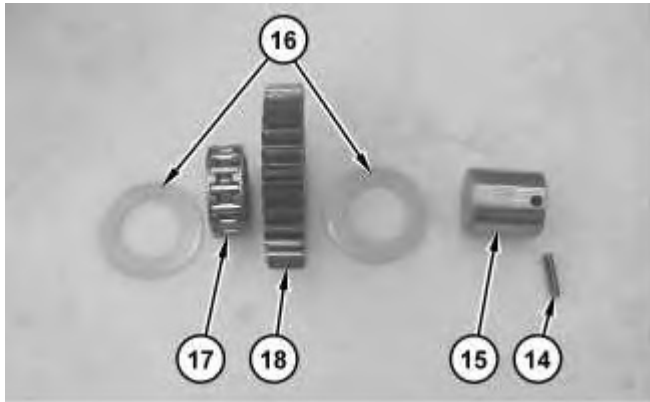

Illustration 9

g01284603

11. Remove washers (16) and bearing (17) from planetary gear (18). Remove spring pin (14) from planetary shaft (15) .
12. Repeat Steps 10 and 11 for the remaining planetary gear assemblies.



Illustration 10

g01284605

13. Use Tooling (B) and a suitable lifting device in order to remove carrier assembly (19). The weight of carrier assembly (19) is approximately 95 kg (210 lb).
-

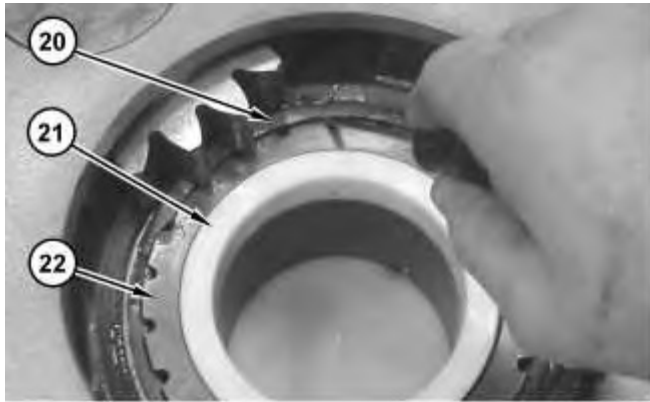

Illustration 11

g01284609

14. Remove retaining ring (20), spacer (21), and sun gear assembly (22) .

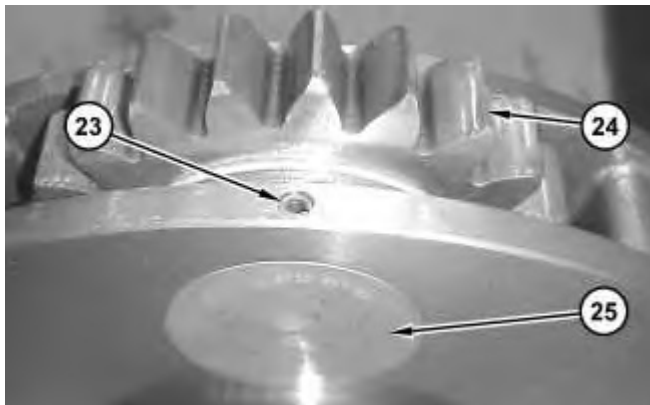

Illustration 12

g01284612

15. Drive spring pin (23) into planetary shaft (25). Remove planetary shaft (25) and planetary gear assembly (24) .

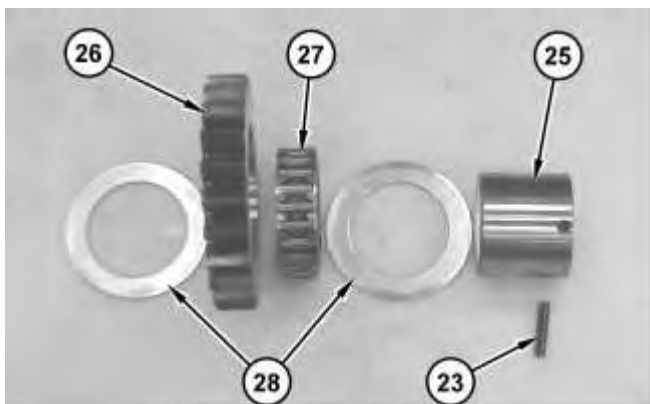

Illustration 13

g01284616

16. Remove washers (28) and bearing (27) from planetary gear (26). Remove spring pin (23) from planetary shaft (25) .
17. Repeat Steps 15 and 16 for the remaining planetary gear assemblies.

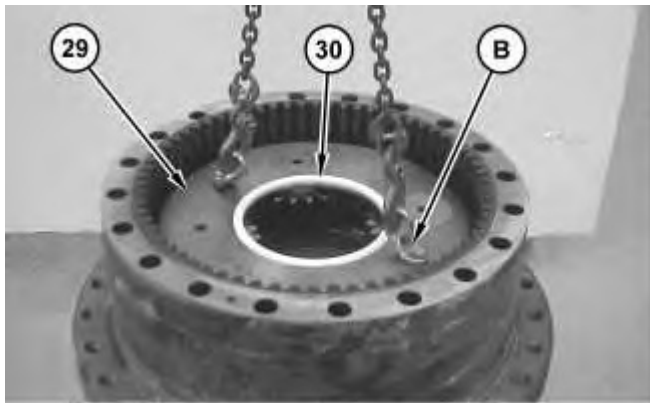

Illustration 14

g01284622

18. Remove spacer (30). Use Tooling (B) and a suitable lifting device in order to remove carrier assembly (29). The weight of carrier assembly (29) is approximately 132 kg (290 lb).



Illustration 15

g01284632

19. Drive spring pin (32) into planetary shaft (33). Remove planetary shaft (33) and planetary gear assembly (31) .
-

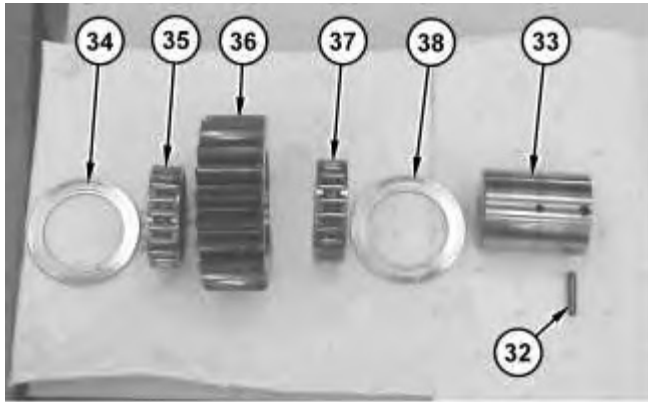

Illustration 16

g01284637

20. Remove washers (34) and (38), and bearings (35) and (37) from planetary gear (36). Remove spring pin (32) from planetary shaft (33) .
21. Repeat Steps 19 and 20 for the remaining planetary gear assemblies.

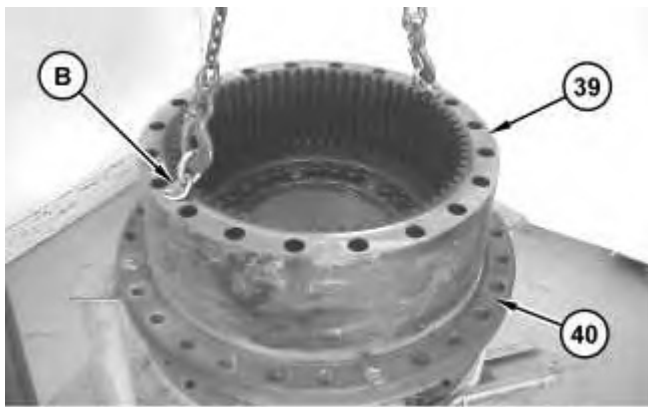
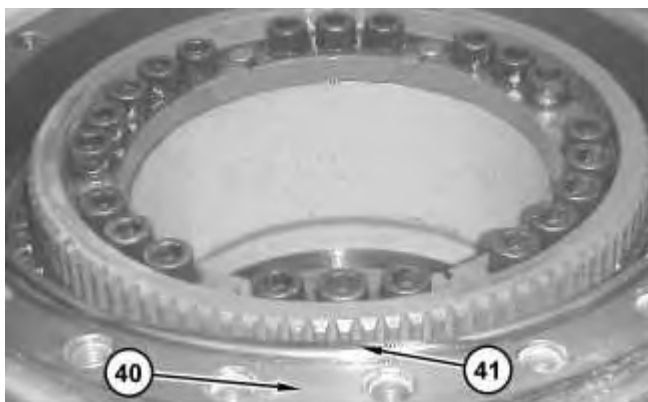

Illustration 17

g01284647

22. Use Tooling (B) and a suitable lifting device in order to remove ring gear (39) from housing (40). The weight of ring gear (39) is approximately 155 kg (340 lb).



23. Remove O-ring seal (41) from housing (40) .



Illustration 19

24. Place suitable cribbing under motor housing (42) in order to support motor housing (42) .

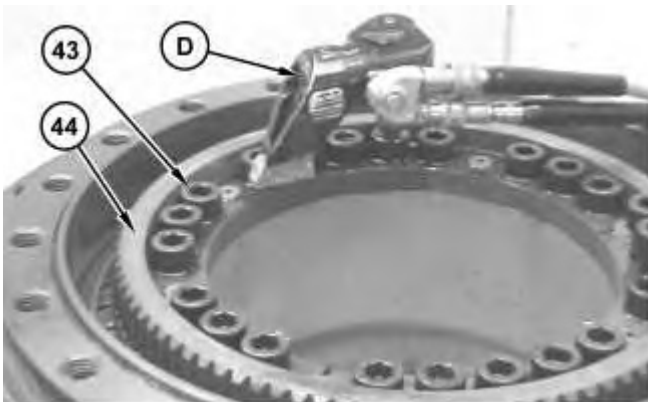
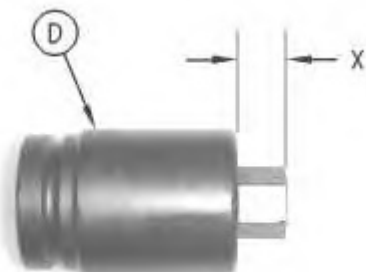
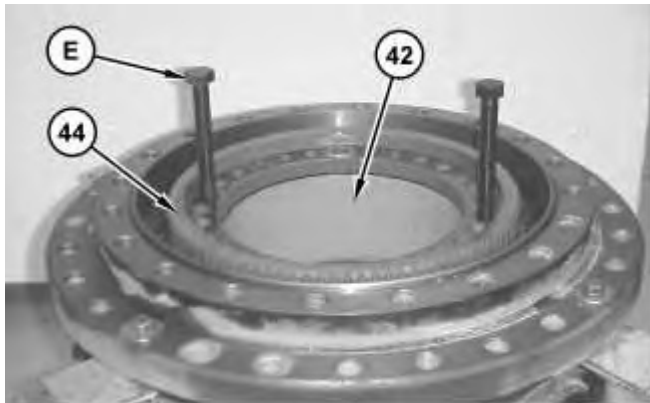

Illustration 20



25. Use Tooling (D) in order to remove bolts (43) from coupling gear (44) .

**Note:** A part of Tooling (D) must be modified. Cut Length (X) on the Hex Bit Socket to a length of 14.0 mm (0.55 inch).



---

Illustration 22

26. Install Tooling (E) in coupling gear (44), as shown. Tighten Tooling (E) evenly in order to loosen coupling gear (44). Remove coupling gear (44) from motor housing (42) .

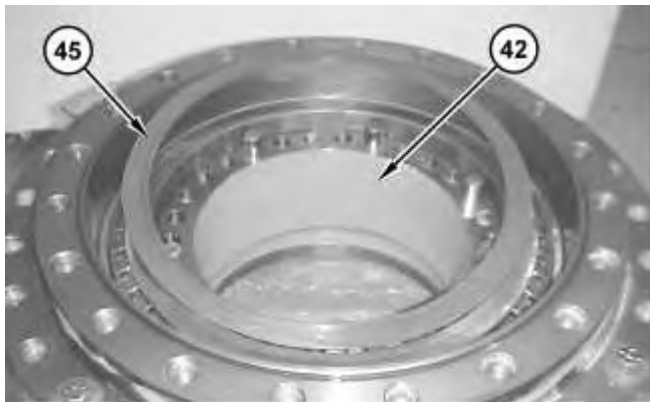

---

Illustration 23

27. Remove shims (45) from motor housing (42) .
-



Illustration 24

g01284723

28. Remove bolts (46). Use Tooling (C) and a suitable lifting device in order to separate housing (40) from motor housing (42). Motor housing (42) will rest on the suitable cribbing. The weight of housing (40) is approximately 250 kg (550 lb).

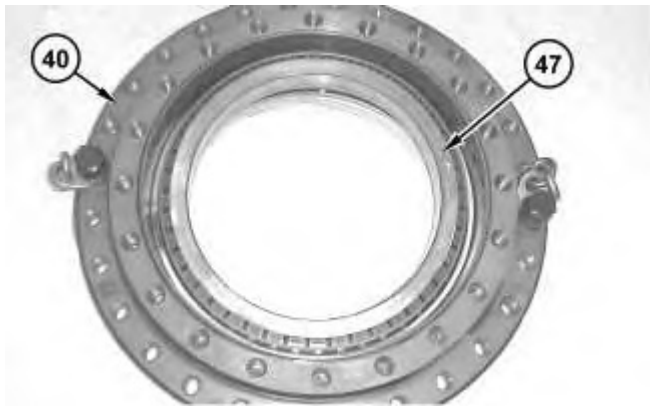

Illustration 25

g01284734

29. Remove bearing cone (47) from housing (40) .

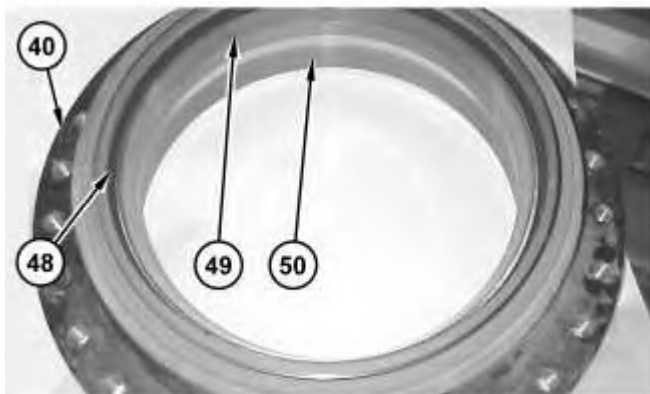

Illustration 26

g01284738

30. Use Tooling (C) and a suitable lifting device in order to flip housing (40) on the other side. The weight of housing (40) is approximately 250 kg (550 lb).
31. Remove Duo-Cone seal (48), and bearing cups (49) and (50) from housing (40) .



Illustration 27

g01284743

32. Remove pins (51) from motor housing (42), if necessary.
33. Remove bearing cone (52) from motor housing (42) .
34. Remove Duo-Cone seal (53) from motor housing (42) .

[Previous Screen](#)

Product: EXCAVATOR

Model: 385C L EXCAVATOR T2E

Configuration: 385C L Excavator T2E00001-UP (MACHINE) POWERED BY C-18 Engine

## Disassembly and Assembly

### 385C Excavator and 385C MHPU Mobile Hydraulic Power Unit Machine Systems

Media Number -REN8620-05

Publication Date -01/02/2012

Date Updated -20/02/2012

i04956682

## Final Drive - Assemble

SMCS - 4050-016

## Assembly Procedure

Table 1

Required Tools			
Tool	Part Number	Part Description	Qty
A	1P-2420	Transmission Repair Stand	1
B	138-7575	Link Bracket	3
C	138-7576	Link Bracket	2
F	205-8241	Installer	1
G	6V-3175	Double Acting Cylinder	1
	3S-6224	Electric Hydraulic Pump Gp	1
	1U-9889	Crossblock	1
	9S-7338	Crossblock	1
	150-1961	Washer	2
	150-1786	Plate	2
	4C-9634	Puller Stud	1
	9U-6832	Nut	1
	2K-7468	Locknut	1
	4K-0684	Locknut	2
	6V-2078	Stud	2

	5P-4807	Cap	2
H	5P-3931	Anti-Seize Compound	1
J	9S-3263	Thread Lock Compound	1
K	1U-8846	Gasket Sealant	1
L	200-5937	Lubricant	1
M	FT-2770	Leak Testing Tool	1

**Note:** Cleanliness is an important factor. Before assembly, thoroughly clean all parts in cleaning fluid. Allow the parts to air dry. Do not use wiping cloths or rags to dry parts. Lint may be deposited on the parts which may cause trouble. Inspect all parts. If any parts are worn or damaged, use new parts for replacement. Dirt and other contaminants can damage the precision component. Perform assembly procedures on a clean work surface. Keep components covered and protected at all times.

**Note:** Check the condition of all the O-ring seals that are used in the final drive. If any of the seals are worn or damaged, use new parts for replacement.

1. Reassemble the final drive on Tooling (A) and suitable cribbing.



Illustration 1

g01284743

**Note:** Refer to Disassembly and Assembly, "Duo-Cone Conventional Seals - Install".

**Note:** The rubber portion of Duo-Cone seal (53) and all surfaces that contact Duo-Cone seal (53) must be clean and dry. After installation of Duo-Cone seal (53), apply Tooling (L) on the contact surfaces of the metal portion of Duo-Cone seal (53).

2. Use Tooling (F) in order to install Duo-Cone seal (53).
3. Apply Tooling (H) to the surfaces on motor housing (42) that will contact bearing cone (52).
4. Raise the temperature of bearing cone (52). Use a suitable press in order to install bearing cone (52) in motor housing (42).

5. Apply Tooling (H) to the surfaces that contact pins (51) . Install pins (51) .

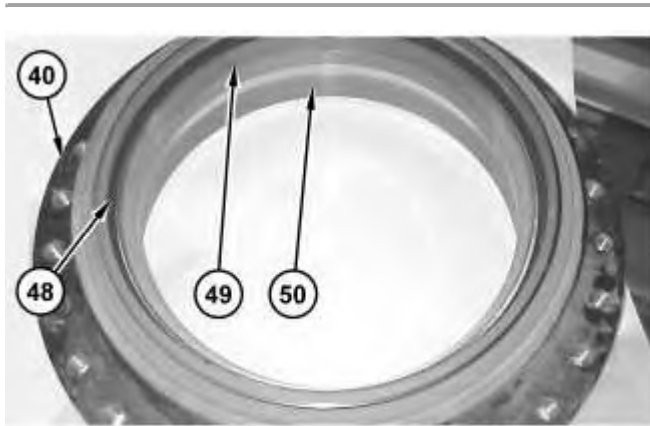

Illustration 2

g01284738

6. Apply Tooling (H) to the surfaces that contact bearing cups (49) and (50) on housing (40) . Install bearing cups (49) and (50) in housing (40) .

**Note:** Refer to Disassembly and Assembly, "Duo-Cone Conventional Seals - Install".

**Note:** The rubber portion of Duo-Cone seal (53) and all surfaces that contact Duo-Cone seal (48) must be clean and dry. After installation of Duo-Cone seal (48) , apply Tooling (L) on the contact surfaces of the metal portion of Duo-Cone seal (48) .

**Note:** Make sure that the Duo-Cone seals (53) and (48) are not scratched or damaged during the assembly of housing (40) or during the assembly of motor housing (42) . After installation of housing (40) on the motor housing (42) , there will be a small gap between the components. The gap is caused by the Duo-Cone seals. The gap will be eliminated during installation of the gear.

7. Use Tooling (F) in order to install Duo-Cone seal (48) .



Illustration 3

g01285518

8. Attach Tooling (C) and a suitable lifting device to housing (40) in order to flip housing (40) on the other side.
9. Use Tooling (C) and a suitable lifting device in order to install housing (40) on motor housing (42) . The weight of the housing (40) is approximately 250 kg (550 lb).



Illustration 4

g01285527

10. Install bearing cone (47) .
11. Use the following procedure to determine the bearing preload and the correct number of shims.

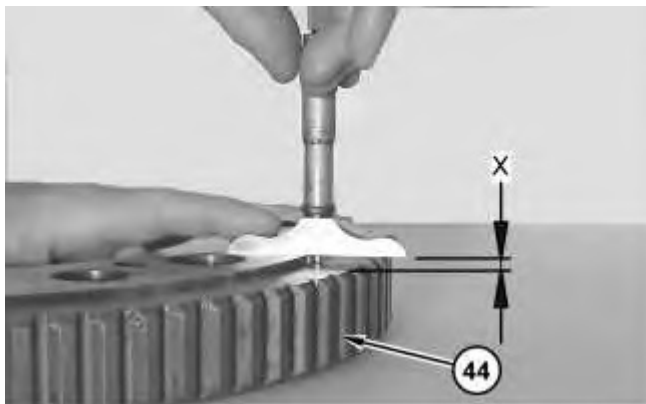

Illustration 5

g01285536

- a. Use a depth micrometer in order to measure the step length of coupling gear (44) . Take measurements at several different locations around gear (44) . Compute the average of the measured dimensions and record the number. Call this Dimension (X) .
-

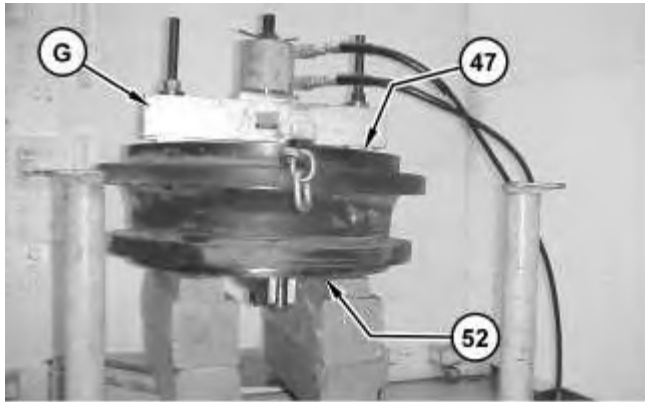

Illustration 6

g01285550

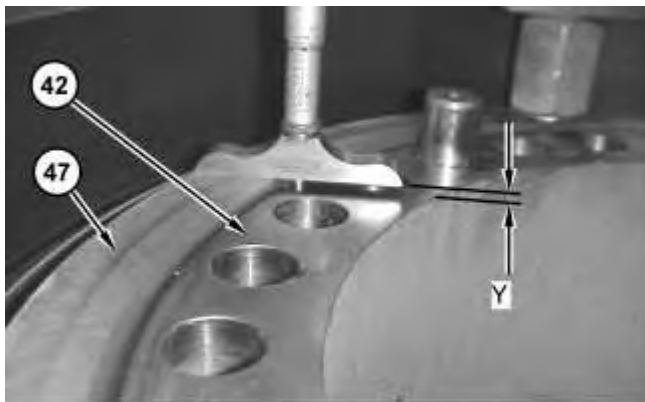

Illustration 7

g01285553

- b. Use Tooling (G) in order to apply a load of 10700 kPa (1550 psi) to bearing cone (47) (not shown) and to bearing cone (52) (not shown). The load will seat bearing cone (47) (not shown) and bearing cone (52) (not shown). A pressure of 10700 kPa (1550 psi) on the electric hydraulic pump of Tooling (G) will result in a pressure of 10000 kg (22050 lb) on bearing cone (47) (not shown) and on bearing cone (52) (not shown). Rotate the housing in order to seat bearing cone (47) (not shown) and bearing cone (52) (not shown). Reduce the load on the electric hydraulic pump of Tooling (G) to 4825 kPa (700 psi).
- c. Rotate Tooling (G) by 90° and repeat Step 11.b.
- d. Maintain the load on bearing cone (47) (not shown) and on bearing cone (52) (not shown). Use a depth micrometer and measure the distance between the top face of housing (42) and bearing cone (47) . Take this measurement in several locations around bearing cone (47) . Compute the average of the measured dimensions and record the number. Call this Dimension (Y) .
- e. Determine the correct thickness of the shim pack that will be installed between bearing cone (47) and coupling gear (44) . The shim pack thickness is equal to Dimension (Y) minus Dimension (X) . Tolerance for the shim pack is 0.10 mm (0.003 inch).



Illustration 8

g01284718

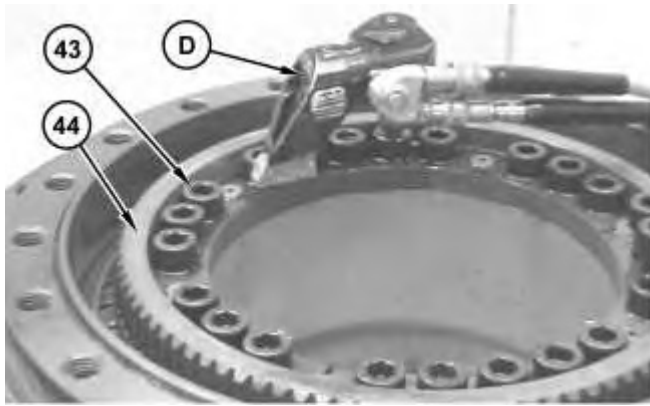

Illustration 9

g01284709

**Note:** If two shims are required, install the thinner shim next to coupling gear (44) when coupling gear (44) is installed.

12. Place shims (45) in the correct position on motor housing (42) . If two shims were required, put the thinner shim in contact with coupling gear (44) . Make sure that all of the holes in the components are in alignment with each other. Put coupling gear (44) in the original position on the motor housing.
  13. Apply Tooling (J) on the threads of bolts (43) . Install bolts (43) in order to secure coupling gear (44) in place. Tighten bolts (43) evenly and tighten bolts (43) in diagonally opposite pairs. Tighten bolts (43) to a torque of  $900 \pm 100 \text{ N}\cdot\text{m}$  ( $665 \pm 75 \text{ lb ft}$ ).
-

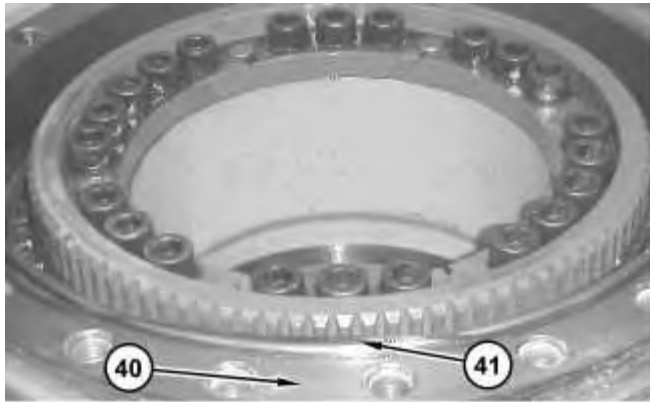

Illustration 10

g01284657

14. Install O-ring seal (41) in main housing (40) .



Illustration 11

g01285592

15. Use Tooling (C) and a suitable lifting device in order to position housing (40) and motor housing (42) on Tooling (A) . Remove the suitable cribbing. The weight of both housings is approximately 430 kg (950 lb).



Illustration 12

g01284647

16. Thoroughly clean the mating surface of housing (40) that contacts ring gear (39) . Apply a bead of Tooling (K) on the mating surface of ring gear (39) . Use Tooling (B) and a suitable lifting device in order to position ring gear (39) on housing (40) . Make sure that the alignment mark on housing (40) and ring gear (39) line up with each other. It may be necessary to use a soft faced hammer to seat ring gear (39) on housing (40) .
17. Assemble planetary gear assembly (31) , as follows:

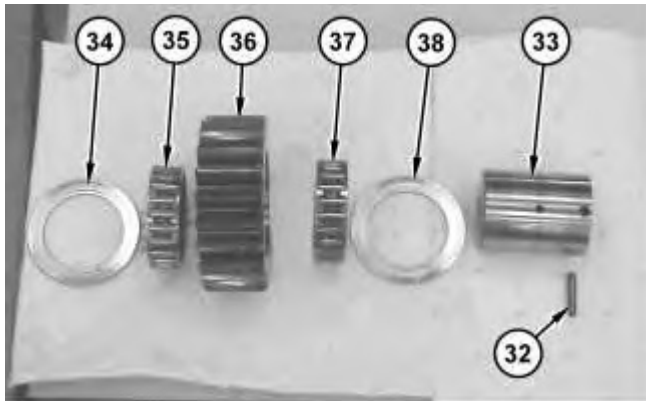

Illustration 13

g01284637



Illustration 14

g01284632

- a. Apply clean SAE 30 oil on bearings (35) and (37) . Install bearings (35) and (37) in planetary gear (36) .
  - b. Install washers (34) and (38) on each side of planetary gear (36) .
  - c. Install planetary gear assembly (31) and washers (34) and (38) in carrier assembly (29) .
  - d. Install planetary shaft (33) in carrier assembly (29) and through planetary gear assembly (31) . Make sure that the spring pin hole in planetary shaft (33) is in alignment with the spring pin hole in the carrier.
-

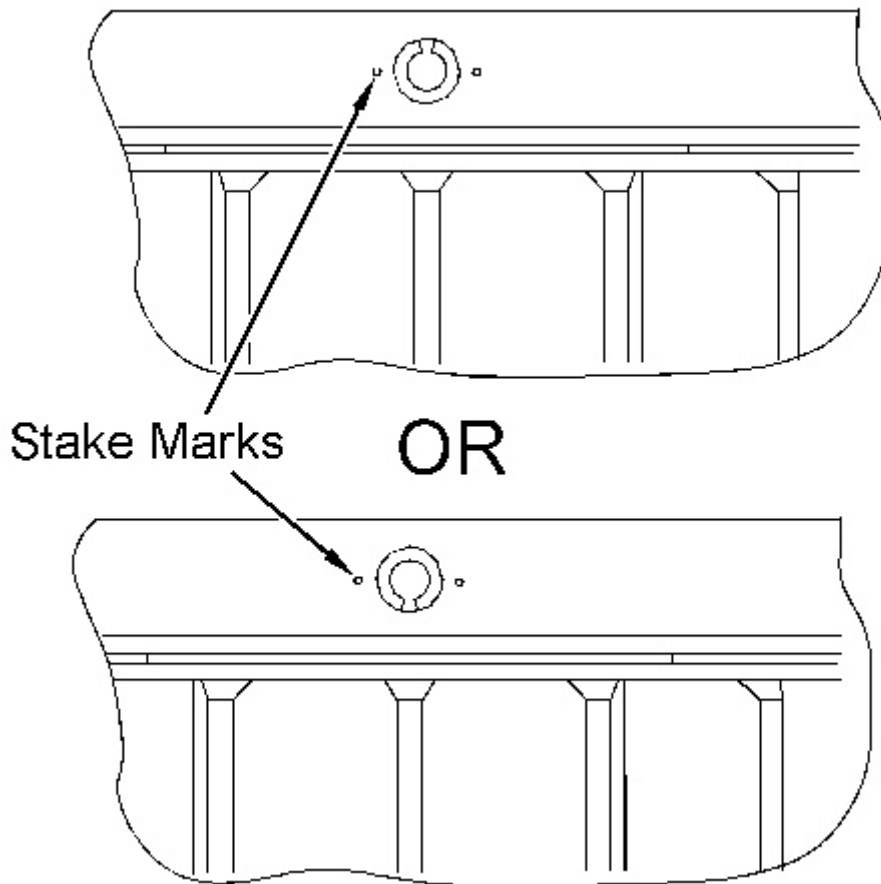

---

Illustration 15

g03142259

- e. Install spring pin (32) in the carrier and into planetary shaft (32) . Make sure that the spring pin hole in planetary shaft (32) is in alignment with the spring pin hole in the carrier.
  - f. Orient the split in spring pin (32) as shown. Make a stake mark on each side of the spring pin hole in the carrier. This will prevent spring pin (32) from falling out of the spring pin hole. Each stake mark should be approximately to  $2.25 \pm 0.75$  mm ( $0.089 \pm 0.030$  inch) from the outside diameter of the spring pin hole.
  - g. Repeat Steps 17.a through 17.f in order to install the other three planetary gear assemblies in carrier assembly (29) .
-

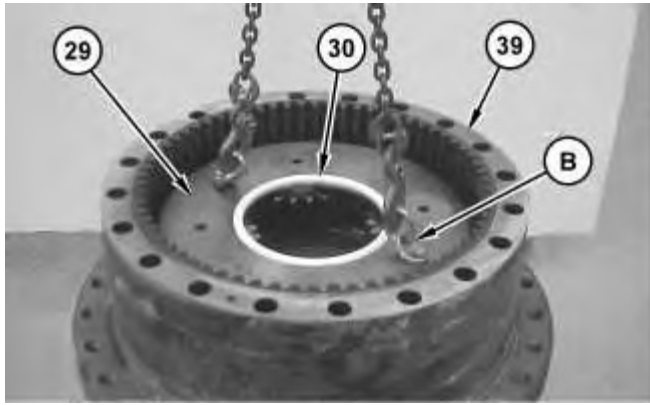

Illustration 16

g01285680

18. Fasten Tooling (B) and a suitable lifting device to carrier assembly (29) . Put carrier assembly (29) in position in ring gear (39) . It may be necessary to move carrier assembly (29) back and forth during installation in order to ensure that all gears engage properly.
19. Install spacer (30) .
20. Assemble planetary gear assembly (24) , as follows:

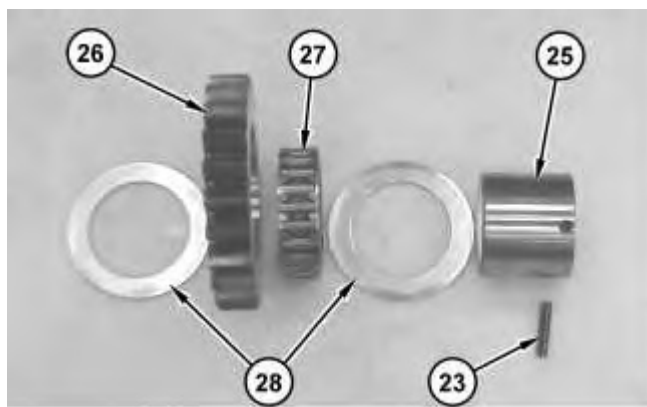

Illustration 17

g01284616

- a. Apply clean SAE 30 oil on bearing (27) . Install bearing (27) in planetary gear (26) .
- b. Install washers (28) on each side of planetary gear assembly (24) .
- c. Install washers (28) and planetary gear assembly (24) in carrier assembly (19) .

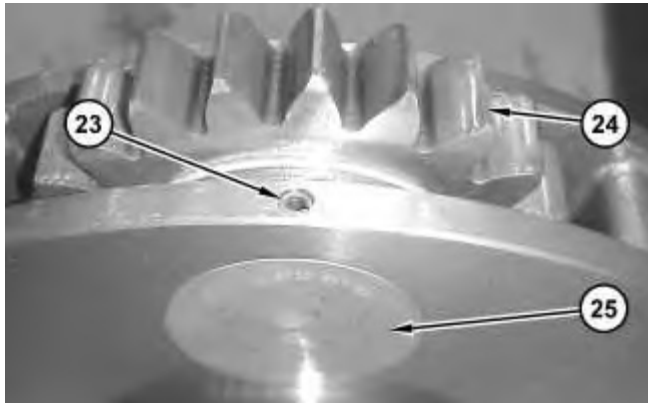

Illustration 18

g01284612

- d. Install planetary shaft (25) in carrier assembly (19) and through planetary gear assembly (24). Make sure that the spring pin hole in planetary shaft (25) is in alignment with the spring pin hole in the carrier.

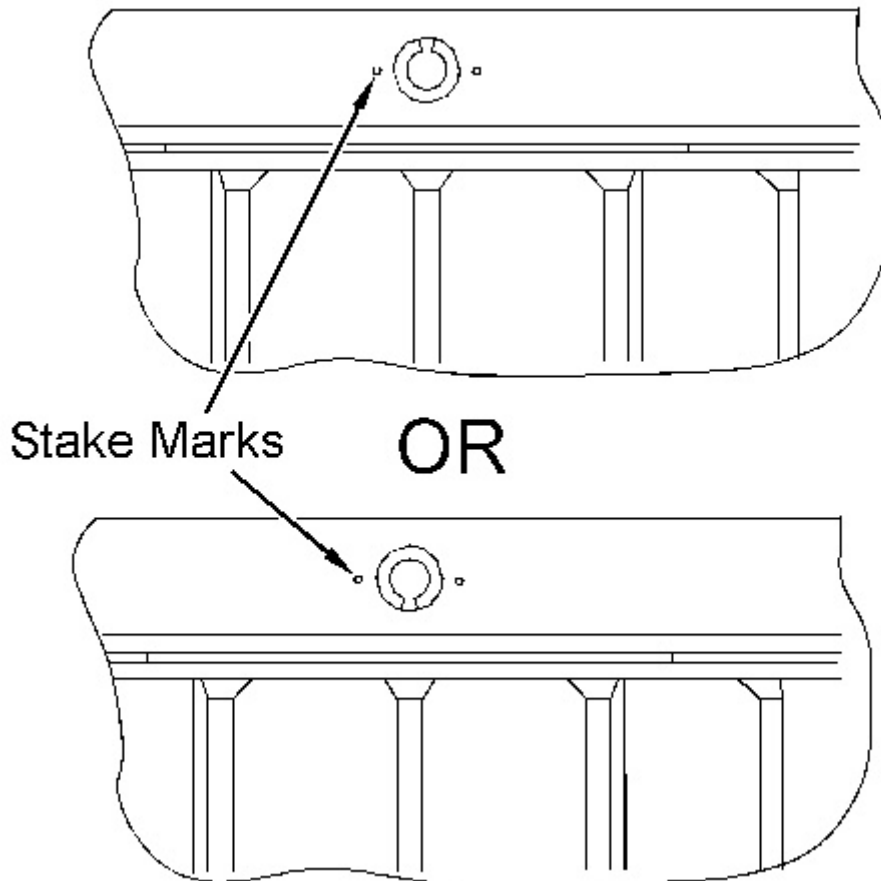

Illustration 19

g03142259

- e. Orient the split in spring pin (23) as shown. Make a stake mark on each side of the spring pin hole in the carrier. This will prevent spring pin (23) from falling out of the spring pin hole. Each stake mark should be approximately to  $2.25 \pm 0.75$  mm ( $0.089 \pm 0.030$  inch) from the outside diameter of the spring pin hole.

- f. Repeat Steps 20.a through 20.e in order to install the other two planetary gear assemblies in carrier assembly (19) .

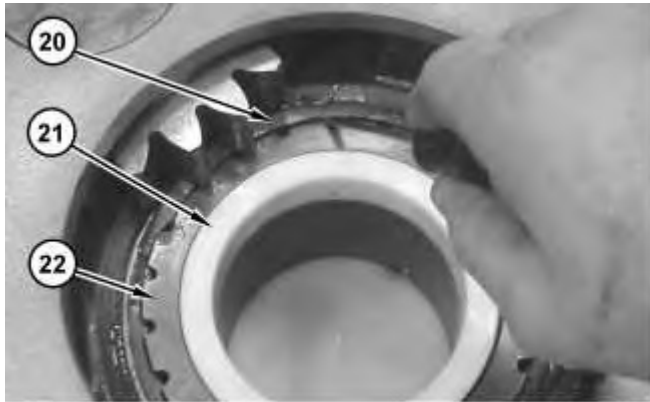

Illustration 20

g01284609

21. Install sun gear assembly (22) , spacer (21) , and retaining ring (20) .



Illustration 21

g01284605

22. Use Tooling (B) and a suitable lifting device in order to install carrier assembly (19) . The weight of carrier assembly (19) is approximately 95 kg (210 lb).
-

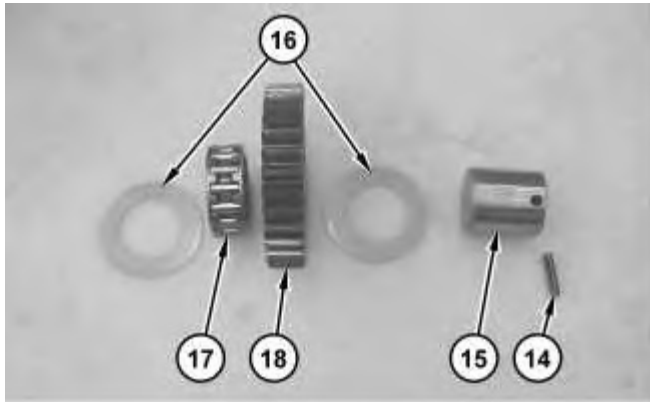

Illustration 22

g01284603

23. Apply clean SAE 30 oil on bearing (17) . Install washers (16) and bearing (17) in planetary gear (18) .

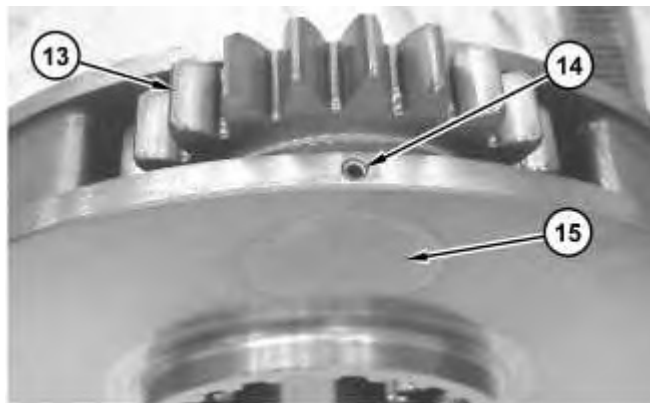

Illustration 23

g01284599

24. Install planetary gear assembly (13) , planetary shaft (15) , and drive spring pin (14) into planetary shaft (15) .
25. Repeat Steps 23 and 24 for the remaining planetary gear assemblies.





**Suggest:**

**If the above button click is invalid.**

**Please download this document first, and then click the above link to download the complete manual.**

**Thank you so much for reading**

26. Install sun gear (12) , spacer (11) , and retaining ring (10) .

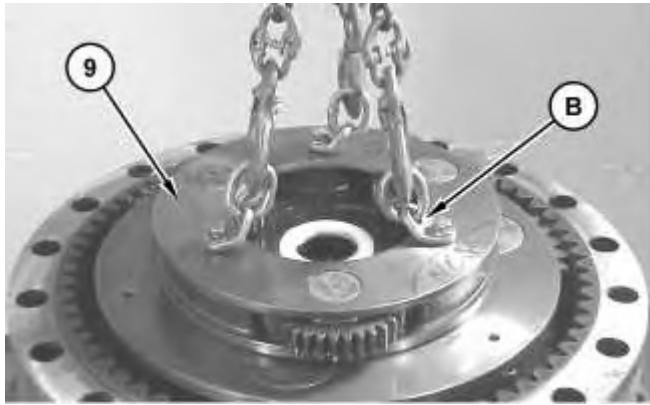

Illustration 25

27. Use Tooling (B) and a suitable lifting device in order to install carrier assembly (9) . The weight of carrier assembly (9) is approximately 43 kg (95 lb).

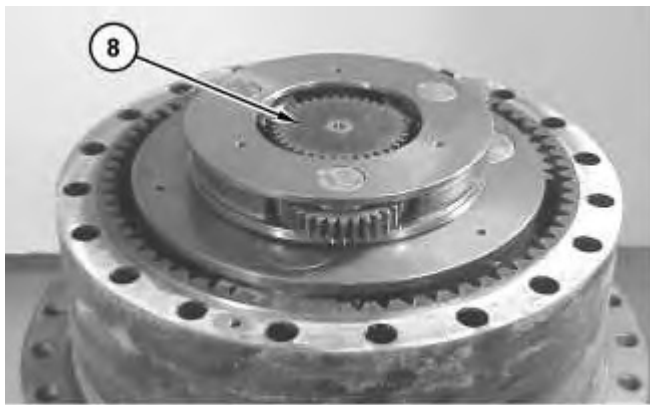

Illustration 26

28. Install sun gear (8) .
-

**<https://www.ebooklibonline.com>**

Hello dear friend!

Thank you very much for reading.

Enter the link into your browser.

The full manual is available for immediate download.

**<https://www.ebooklibonline.com>**