



# Service Repair Manual

## **Models**

345B, 345B L and 345B LC  
Excavator

---

<b>Required Tools</b>			
<b>Tool</b>	<b>Part Number</b>	<b>Part Description</b>	<b>Qty</b>
(A)	1P-2420	Transmission Repair Stand	1
(B)	1P-1859	Pliers	1
(C)	1P-1863	Pliers	1
(D)	138-7575	Link Bracket	2

---

### **NOTICE**

**Care must be taken to ensure that fluids are contained during performance of inspection, maintenance, testing, adjusting and repair of the product. Be prepared to collect the fluid with suitable containers before opening any compartment or disassembling any component containing fluids.**

**Refer to Special Publication, NENG2500, "Caterpillar Tools and Shop Products Guide" for tools and supplies suitable to collect and contain fluids on Caterpillar products.**

**Dispose of all fluids according to local regulations and mandates.**

---



---

### **NOTICE**

**Failure to properly assemble parts or failure to follow established procedures can lead to damage to the parts and assembly.**

**To avoid damage to parts, always identify and mark the parts so that they can be installed into the same location. Never force parts during assembly. Keep parts clean and lubricated.**

---



---

### **NOTICE**

**Keep all parts clean from contaminants.**

**Contamination of the hydraulic system with foreign material will reduce the service life of the hydraulic system components.**

**To prevent contaminants from entering the hydraulic system, always plug or cap the lines, fittings, or hoses as they are disconnected. Cover any disassembled components and clean them properly before assembly.**

**Clean the hydraulic system properly after any major component exchange or especially after a component failure, to remove any contamination.**

---

**Note:** If a failure occurs, an accurate diagnosis of the cause can prevent a recurrence. Information is available to analyze failures for piston pumps and motors. Refer to Special Publication, SEBD0641, "Analyzing Axial Piston Pump and Motor Failures".

**Note:** Inspect all parts. If any parts are worn or damaged use new parts for replacement. The installation of used parts during reconditioning is acceptable. Reuse and salvage information is available on piston pumps. Refer to Guideline for Reusable Parts and Salvage Operations, SEBF8032, "Piston Pumps and Motors". During reconditioning, correct any conditions that might have caused the original failure.

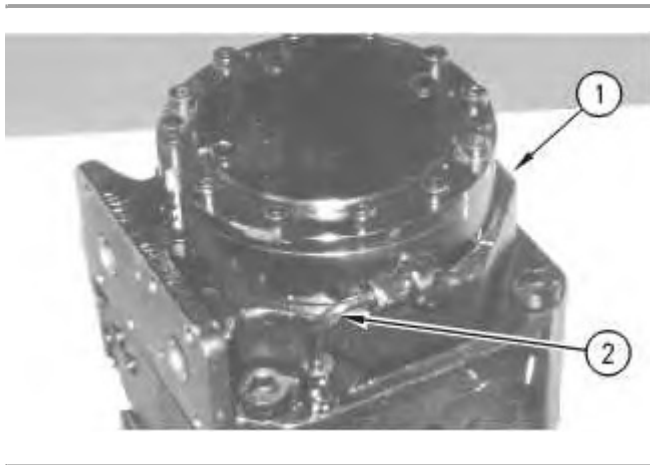

Illustration 1

g00633207

1. Thoroughly clean the outside of the travel motor prior to disassembly. Fasten travel motor (1) to Tool (A). The weight of the travel motor is 125 kg (275 lb).
2. Put an alignment mark across all housings of the travel motor for assembly purposes.
3. Disconnect tube assembly (2) .

** WARNING**

**Personal injury can result from parts and/or covers under spring pressure.**

**Spring force will be released when covers are removed.**

**Be prepared to hold spring loaded covers as the bolts are loosened.**

---

**<https://www.ebooklibonline.com>**

Hello dear friend!

Thank you very much for reading.

Enter the link into your browser.

The full manual is available for immediate download.

**<https://www.ebooklibonline.com>**

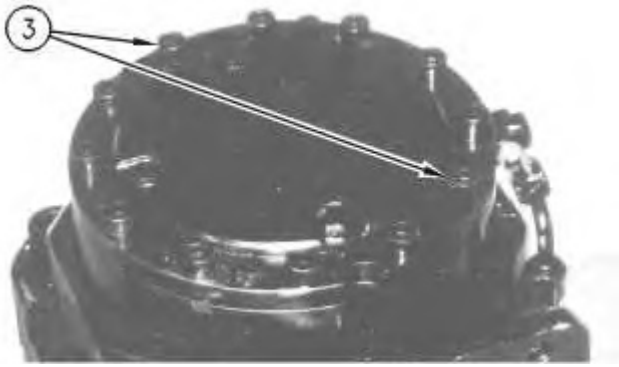

---

Illustration 2

g00633208

---

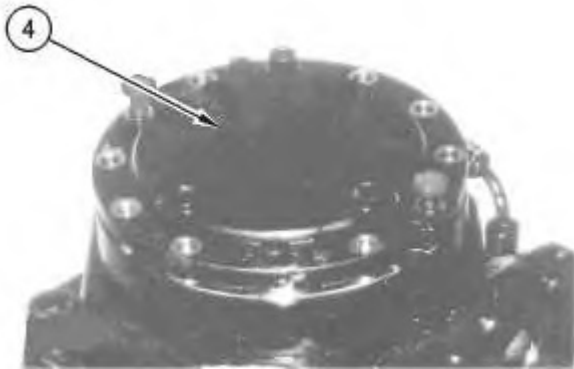

---

Illustration 3

g00633209

---

4. Remove two socket head bolts (3) from the brake cover that are 180 degrees from each other. Replace these two bolts with bolts that are slightly longer in length. The two longer bolts will retain the brake cover when the remaining socket head bolts (3) are removed.
5. Evenly remove the remaining socket head bolts (3) that hold the brake cover in position. Remove the two longer bolts (3). Remove brake cover (4) from the brake assembly.



6. If necessary, remove brake adjusting screws (5) from the brake cover.

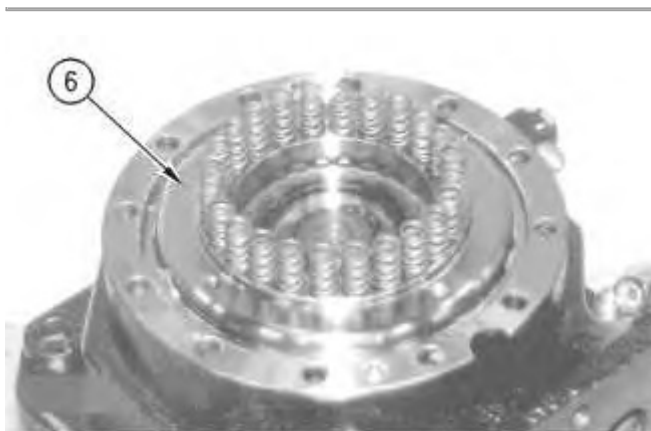

Illustration 5

7. Remove brake assembly (6) from the head assembly.

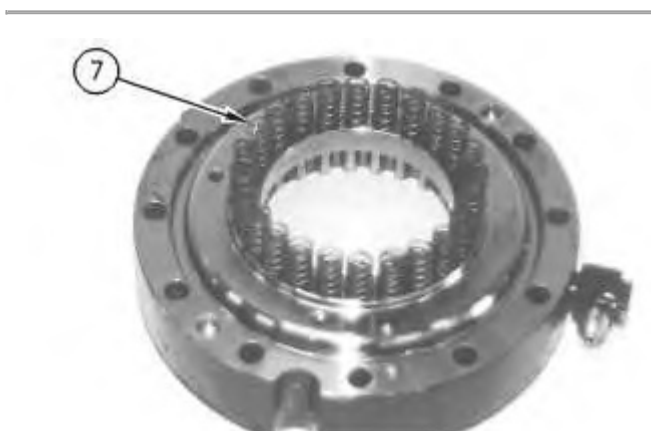

Illustration 6

**Note:** There is an inner spring and an outer spring in each spring set.

8. Remove spring sets (7) from the brake piston.
-



---

Illustration 7

g00633214

9. Turn the brake housing to the other side. Remove O-ring seal (8) .



---

Illustration 8

g00633216

10. Use two suitable forcing screws (9) in order to remove brake piston (10) from the brake housing.



---

Illustration 9

g00633217

11. Remove discs (11) and plates (12) .

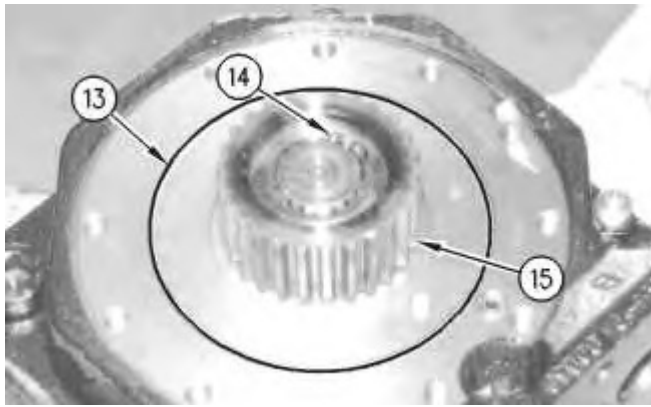

Illustration 10

g00633218

12. Remove O-ring seal (13) .

13. Use Tool (B) in order to remove retaining ring (14). Remove gear (15) .

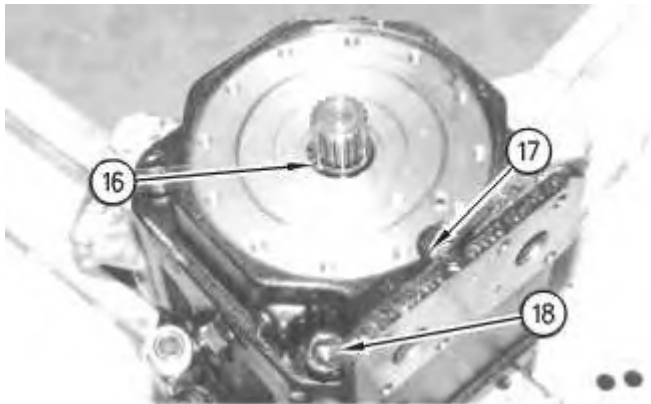

Illustration 11

g00633219

14. Use Tool (C) in order to remove retaining ring (16) .

15. Remove the nut and bushing (17) from the rod assembly.

16. Remove four socket head bolts (18) that hold the head assembly to the motor housing.

---

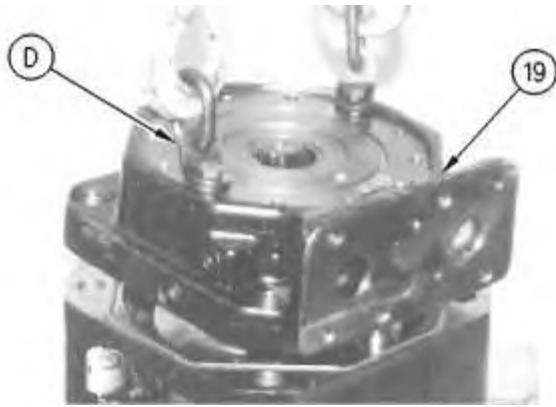

---

Illustration 12

g00633220

17. Fasten Tool (D) and a hoist to head assembly (19), as shown. Carefully remove the head assembly from the motor housing. The weight of the head assembly is 25 kg (55 lb).

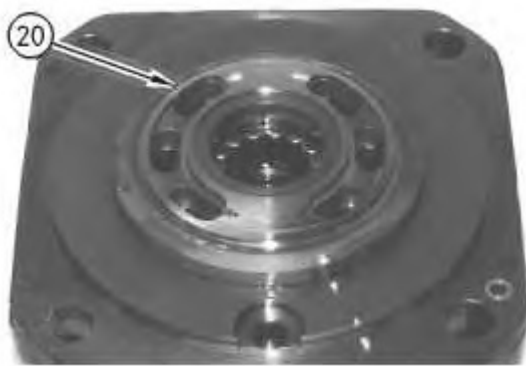

---

Illustration 13

g00633221

18. Remove thrust plate (20) from the head.

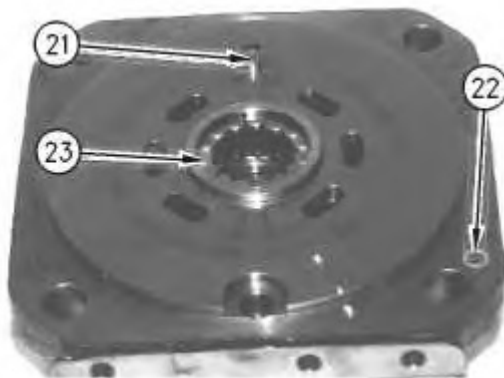

---

Illustration 14

g00633223

19. Remove O-ring seal (22) from the head.
20. Remove bearing (23) from the head.
21. Remove pin (21) from the head.

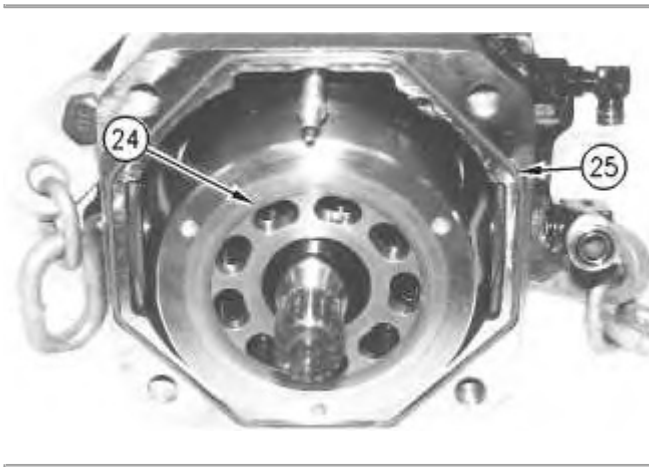

Illustration 15

g00633224

22. Remove O-ring seal (25) from the motor housing.
23. Turn the motor housing on the side, as shown.

**Note:** Keep the components together, while you remove the barrel assembly from the motor housing. All parts in the barrel assembly must be reinstalled in the original locations.

24. Carefully remove barrel assembly (24) from the motor housing so the components do not come apart.
25. Disassemble barrel assembly (24), as follows:



Illustration 16

g00633225

- a. Place identification marks on piston assemblies (27), retainer (26), and barrel (28). Remove piston assemblies (27), and retainer (26) from barrel (28) .

b. Separate piston assemblies (27) from retainer (26) .

---



---

Illustration 17

g00633227

c. Remove guide (29) from the barrel.

---



---

Illustration 18

g00633228

**Note:** Take note of the shims (30) that are positioned on the barrel for installation purposes.

d. Remove shims (30) from the barrel.

---

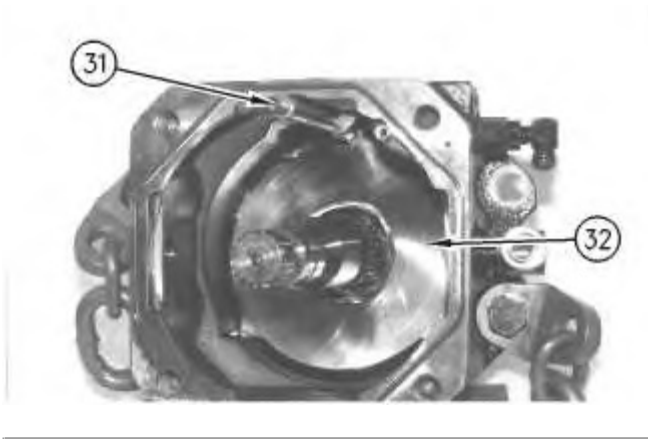

Illustration 19

g00633230

26. Remove adjusting screw (31) from the motor housing. Remove the O-ring seal from the adjusting screw.
27. Remove swashplate assembly (32) from the motor housing.
28. Disassemble the swashplate assembly, as follows:



Illustration 20

g00633231

- a. Remove plate (33) .

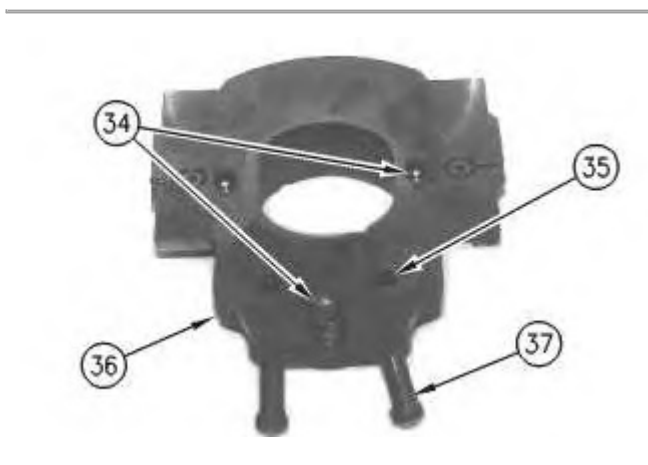

- b. Remove three pins (34) from the plate.
- c. Remove two screws (35) .
- d. Remove plate (36) .
- e. Remove two plungers (37) .



Illustration 22

g00633235

29. Use Tool (B) in order to remove retaining ring (38) that holds shaft assembly (39) in the motor housing.



Illustration 23

g00633238

30. Use a soft faced hammer in order to remove shaft assembly (39) from the motor housing in the direction that is shown.
  31. Disassemble shaft assembly (39), as follows:
-



---

Illustration 24

g00633239

- a. Remove O-ring seal (40) from cover (41) .
- b. Remove cover (41) from the shaft.



---

Illustration 25

g00633241

- c. Remove lip seal (42) from cover (41) .

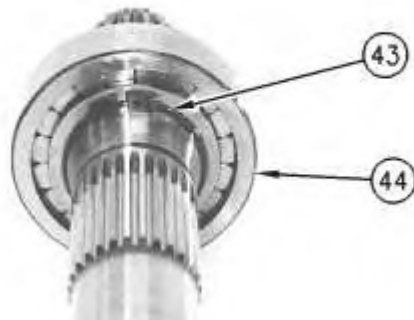

---

Illustration 26

g00633243

- d. Use Tool (C) in order to remove retaining ring (43) that holds bearing (44) in position on the shaft.

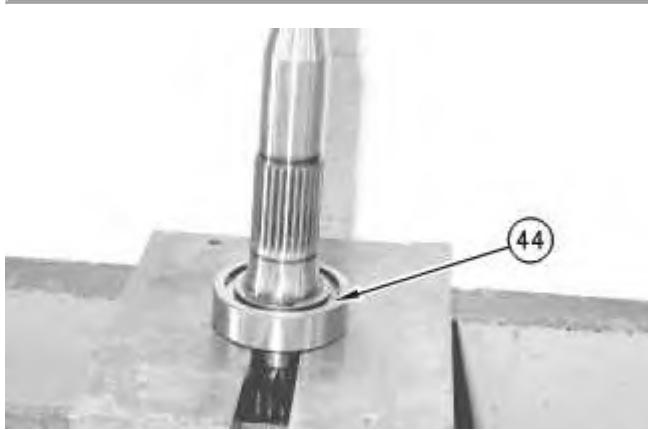

Illustration 27

g00633245

- e. Put the shaft in a press, as shown. Press the shaft out of bearing (44) .

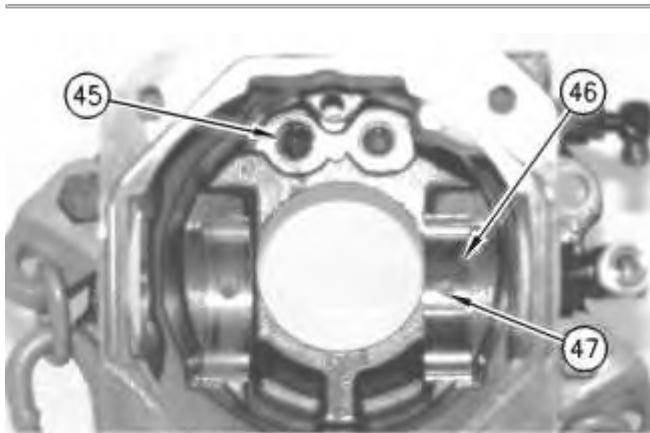

Illustration 28

g00633246

32. Remove two screws (47) and two bearings (46) from the motor housing. Remove two bushings (45) from the motor housing.

[Previous Screen](#)

Product: EXCAVATOR

Model: 345B EXCAVATOR BFG

Configuration: 345B, 345B L &amp; 345B LC Excavator BFG00001-UP (MACHINE) POWERED BY 3176C Engine

## Disassembly and Assembly

### 345B, 345B Series II and W345B Series II Excavators Machine Systems

Media Number -SEN1934-11

Publication Date -01/01/2012

Date Updated -12/01/2012

i03721001

## Travel Motor - Assemble - Series I

SMCS - 4351-016

S/N - 2NW1-UP

S/N - 2SW1-UP

S/N - 2ZW1-UP

S/N - 3MW1-UP

S/N - 4SS1-UP

S/N - 5WS1-UP

S/N - 6MW1-UP

S/N - 6XS1-UP

S/N - 7KS1-UP

S/N - 8KW1-UP

S/N - 8RW1-UP

S/N - 9CW1-UP

S/N - 9GS1-UP

S/N - BFG1-UP

## Installation Procedure

Table 1

--

<b>Required Tools</b>			
<b>Tool</b>	<b>Part Number</b>	<b>Part Description</b>	<b>Qty</b>
(A)	1P-2420	Transmission Repair Stand	1
(B)	1P-1859	Pliers	1
(C)	1P-1863	Pliers	1
(D)	138-7575	Link Bracket	2
(E)	1P-0520	Driver Group	1

---

## **NOTICE**

**Keep all parts clean from contaminants.**

**Contamination of the hydraulic system with foreign material will reduce the service life of the hydraulic system components.**

**To prevent contaminants from entering the hydraulic system, always plug or cap the lines, fittings, or hoses as they are disconnected. Cover any disassembled components and clean them properly before assembly.**

**Clean the hydraulic system properly after any major component exchange or especially after a component failure, to remove any contamination.**

---

**Note:** If a failure occurs, an accurate diagnosis of the cause can prevent a recurrence. Information is available to analyze failures for piston pumps and motors. Refer to Special Publication, SEBD0641, "Analyzing Axial Piston Pump and Motor Failures".

**Note:** Inspect all parts. If any parts are worn or damaged use new parts for replacement. The installation of used parts during reconditioning is acceptable. Reuse and salvage information is available on piston pumps. Refer to Guideline For Reusable Parts and Salvage Operations, SEBF8032, "Piston Pumps and Motors". During reconditioning, correct any conditions that might have caused the original failure.

**Note:** O-rings, gaskets, and seals should always be replaced. A used O-ring may not have the same sealing properties as a new O-ring. Use **1U-6396** O-Ring Assembly Compound during the assembly procedure.

**Note:** Apply a light film of "10W" oil to all components before assembly.

---

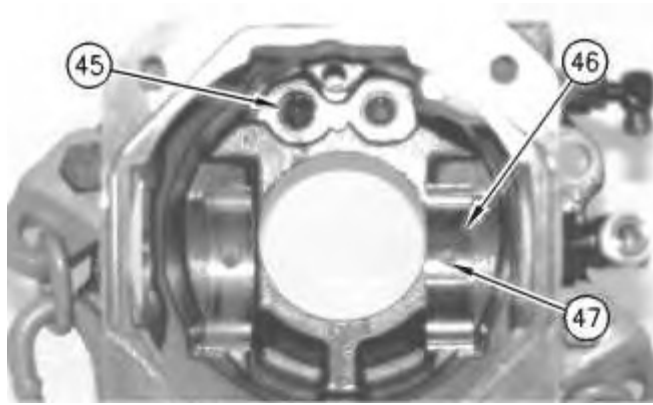

Illustration 1

g00633246

1. Use Tool (E) in order to install two bushings (45) in the motor housing. Install the bushings until the bushings are seated in the motor housing.
2. Put two bearings (46) in position in the motor housing, as shown.
3. Put **9S-3263** Thread Lock Compound on the threads of two screws (47) .
4. Install the two screws, and tighten the screws to a torque of 5 N·m (44 lb in).
5. Assemble shaft assembly (39) , as follows:

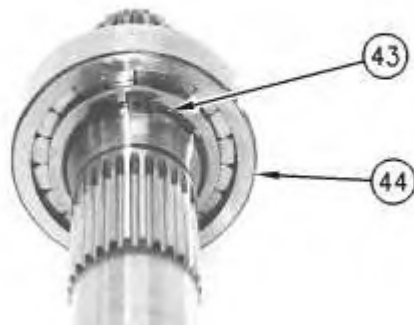

Illustration 2

g00633243

- a. Heat bearing (44) . Install the bearing until the bearing makes contact with the shoulder on the shaft.
- b. Use Tool (C) in order to install retaining ring (43) .



---

Illustration 3

g00633241

- c. Use Tool (E) in order to install lip seal (42) in cover (41) .
- d. Install the seal until the seal makes contact with the counterbore in the cover and with the sealing lip facing toward the inside. Lubricate the lip of the seal with clean hydraulic oil.



---

Illustration 4

g00633239

- e. Install cover (41) on the shaft, as shown.
  - f. Install O-ring seal (40) on the cover. Lubricate the O-ring seal with clean hydraulic oil.
-



---

Illustration 5

g00633235

6. Use a soft faced hammer in order to install shaft assembly (39) in the motor housing. Make sure that the shaft assembly is seated in the motor housing.
7. Use Tool (B) in order to install retaining ring (38) in the motor housing.
8. Assemble the swashplate assembly, as follows:

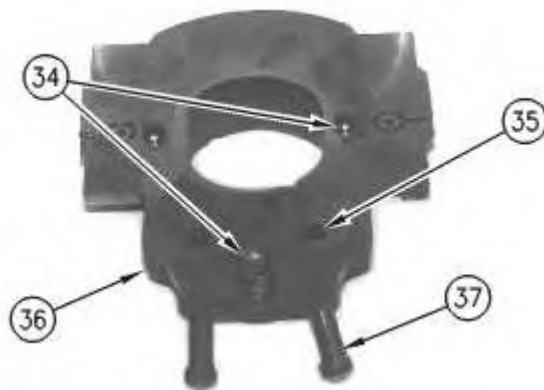

---

Illustration 6

g00633232

- a. Install two plungers (37) .
  - b. Install plate (36) .
  - c. Install two screws (35) .
  - d. Install three pins (34) in the plate.
-



---

Illustration 7

g00633231

e. Install plate (33) .

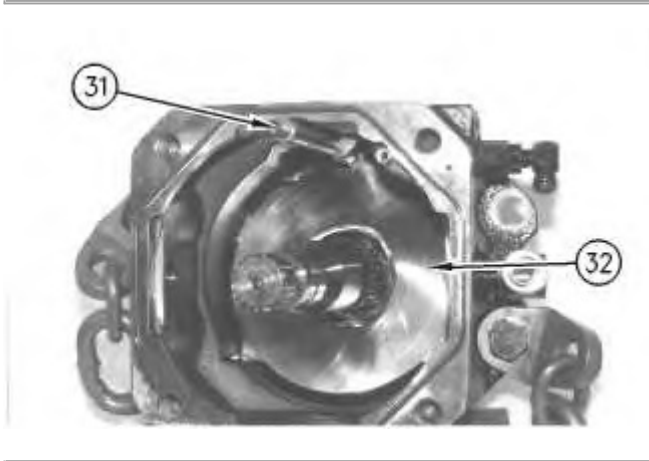

---

Illustration 8

g00633230

9. Install swashplate assembly (32) in the motor housing, as shown.
10. Install the O-ring seal on adjusting screw (31) . Install the screw for adjusting in the motor housing.
11. Assemble barrel assembly (24) , as follows:



---

Illustration 9

g00633228

- a. Install the original amount of shims (30) on the barrel. Make sure that the shims are installed in the original positions.
- 



Illustration 10

g00633227

- b. Install guide (29) on the barrel, as shown. Make sure that the guide is seated squarely.
- 



Illustration 11

g00633225

- c. Install nine piston assemblies (27) in the original location in retainer (26) .
- d. Install the piston assemblies with the retainer in the original location in the barrel.
-



Illustration 12

g00633227

**Note:** Make sure that the barrel assembly (24) does not fall apart during installation in the motor housing.

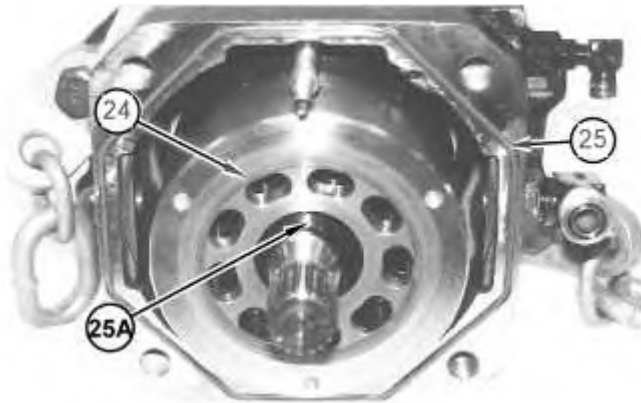
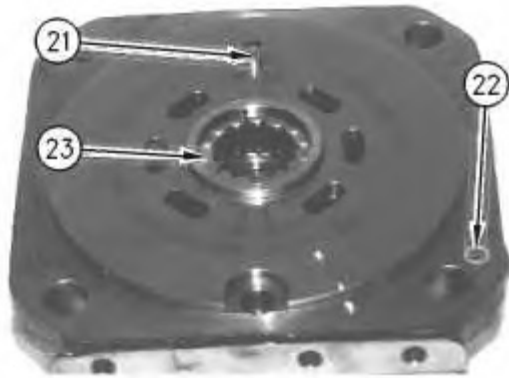

Illustration 13

g02005414

12. Carefully install barrel assembly (24) over the shaft in the motor housing. Make sure that the components of the barrel assembly do not fall apart during installation. Install lip type seal (25A) .
  13. Install O-ring seal (25) in the motor housing.
-



---

Illustration 14

g00633223

14. Install pin (21) in the head.
15. Install bearing (23) in the head. Make sure that the bearing makes contact with the counterbore in the head during installation.
16. Install O-ring seal (22) in the head.

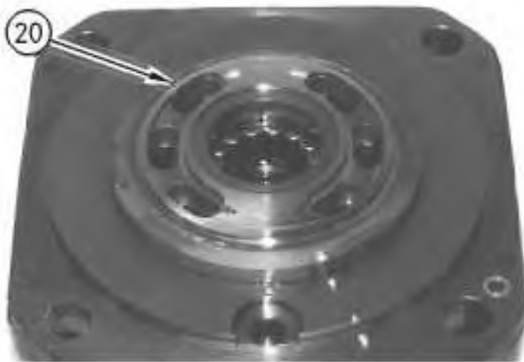

---

Illustration 15

g00633221

17. Install thrust plate (20) on the head, as shown.
-

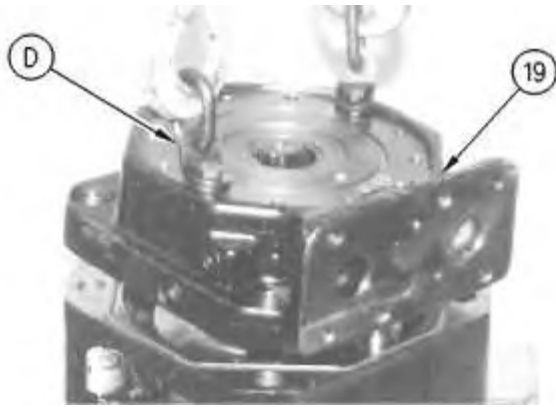

Illustration 16

g00633220

18. Fasten Tool (D) and a hoist to head assembly (19) , as shown. Carefully put the head assembly in the original position on the motor housing.

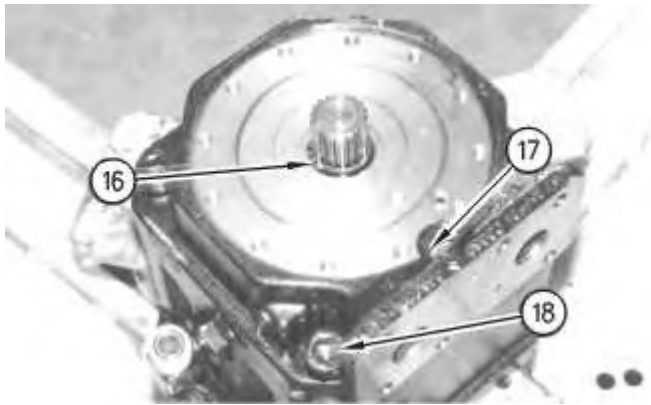

Illustration 17

g00633219

19. Put **9S-3263** Thread Lock Compound on the threads of four socket head bolts (18) .
20. Install four socket head bolts (18) that hold the head assembly to the motor housing.
21. Put **9S-3263** Thread Lock Compound on the threads of bushing (17) .
22. Install the bushing and the nut on the rod assembly in the motor housing.
23. Use Tool (C) in order to install retaining ring (16) on the shaft.

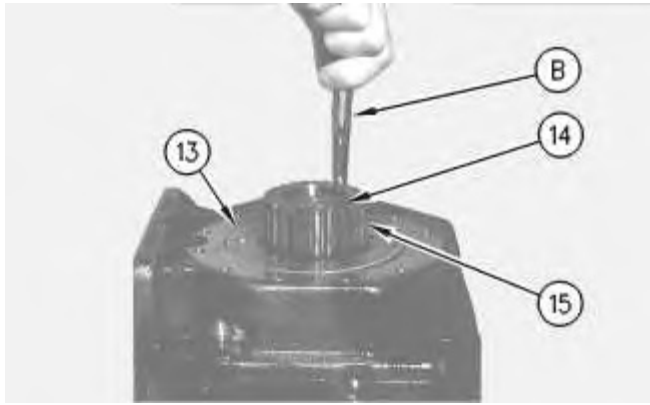

Illustration 18

g00633416

24. Put gear (15) in position on the shaft. Use Tool (B) in order to install retaining ring (14) . This will hold the gear in position.
25. Install O-ring seal (13) in the head assembly.



Illustration 19

g00633421

26. Install discs (11) and plates (12) in alternating order. Start with a disc and end with a disc.





**Suggest:**

**If the above button click is invalid.**

**Please download this document**

**first, and then click the above link**

**to download the complete manual.**

**Thank you so much for reading**

27. Install brake piston (10) in the brake housing.



Illustration 21

28. Turn the brake housing on the other side. Install O-ring seal (8) in the brake housing.



Illustration 22

**Note:** There is an inner spring and an outer spring in each spring set.

29. Install spring sets (7) in the brake piston.

---

**<https://www.ebooklibonline.com>**

Hello dear friend!

Thank you very much for reading.

Enter the link into your browser.

The full manual is available for immediate download.

**<https://www.ebooklibonline.com>**