



# Service Repair Manual

## **Models**

**330B L and 330B LN Excavator**

---

[Previous Screen](#)

Product: EXCAVATOR

Model: 330B L EXCAVATOR 3YR

Configuration: 330B L, 330B LN Excavators 3YR00001-UP (MACHINE) POWERED BY 3306 Engine

## Disassembly and Assembly 3304B and 3306B Engines for Caterpillar Built Machines

Media Number -SEN5598-09

Publication Date -01/01/2013

Date Updated -25/01/2013

i00921612

# Compression Brake - Install

SMCS - 1119-012

## Installation Procedure

---

### NOTICE

**Keep all parts clean from contaminants.**

**Contaminants may cause rapid wear and shortened component life.**

---

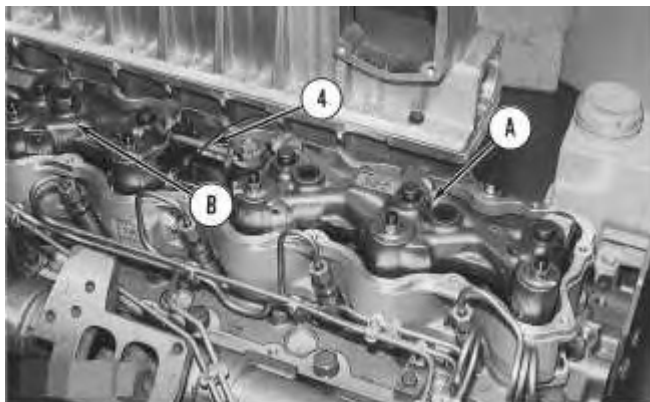
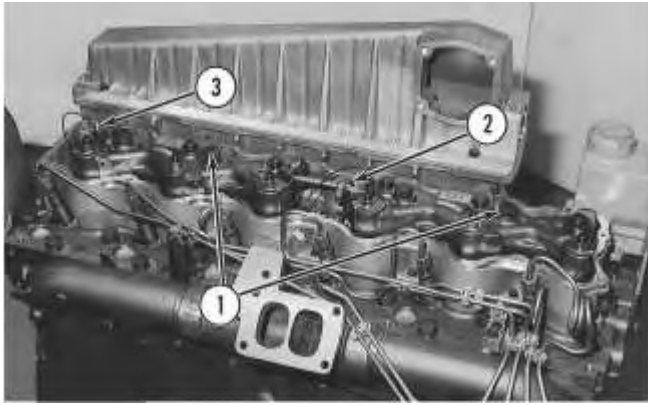

Illustration 1

g00471010

1. Install Compression Brake (B) and oil tube (4) .
2. Install Compression Brake (A) .



---

Illustration 2

g00471009

3. Connect wires (3) and (2). Install four bolts (1) .

**End By:** Install the valve mechanism cover. Refer to Disassembly and Assembly, "Valve Mechanism Cover - Remove and Install".

**<https://www.ebooklibonline.com>**

Hello dear friend!

Thank you very much for reading.

Enter the link into your browser.

The full manual is available for immediate download.

**<https://www.ebooklibonline.com>**

[Previous Screen](#)

Product: EXCAVATOR

Model: 330B L EXCAVATOR 3YR

Configuration: 330B L, 330B LN Excavators 3YR00001-UP (MACHINE) POWERED BY 3306 Engine

## Disassembly and Assembly 3304B and 3306B Engines for Caterpillar Built Machines

Media Number -SEN5598-09

Publication Date -01/01/2013

Date Updated -25/01/2013

i00999978

# Rocker Shaft and Pushrod - Remove

SMCS - 1102-011; 1208-011

## Removal Procedure

### Start By:

- A. Remove the valve mechanism cover. Refer to Disassembly and Assembly, "Valve Mechanism Cover - Remove and Install".

---

### NOTICE

**Keep all parts clean from contaminants.**

**Contaminants may cause rapid wear and shortened component life.**

---

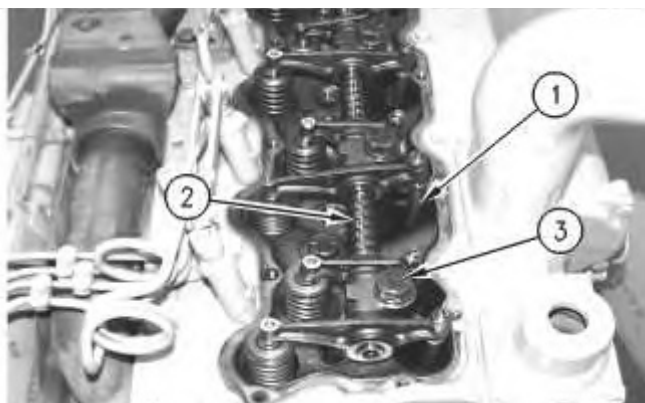

Illustration 1

g00539802

1. Remove six bolts (3) and rocker shaft assembly (2). Remove the O-ring seal from the rear rocker shaft support.
2. Put identification marks on pushrods (1) in order to identify the location of the pushrods in the engine. Remove pushrods (1) from the engine. Repeat this process for each pushrod.

[Previous Screen](#)

Product: EXCAVATOR

Model: 330B L EXCAVATOR 3YR

Configuration: 330B L, 330B LN Excavators 3YR00001-UP (MACHINE) POWERED BY 3306 Engine

## Disassembly and Assembly 3304B and 3306B Engines for Caterpillar Built Machines

Media Number -SEN5598-09

Publication Date -01/01/2013

Date Updated -25/01/2013

i01001004

## Rocker Shaft - Disassemble

SMCS - 1102-015

## Disassembly Procedure

### Start By:

- A. Remove the rocker shaft and pushrods. Refer to Disassembly and Assembly, "Rocker Shaft and Pushrods - Remove".

---

### NOTICE

**Keep all parts clean from contaminants.**

**Contaminants may cause rapid wear and shortened component life.**

---



Illustration 1

g00490026

1. Remove O-ring seal (1) from the rear support bracket.

**Note:** Replace the O-ring seal when the head bolt is removed from the rear rocker shaft support.

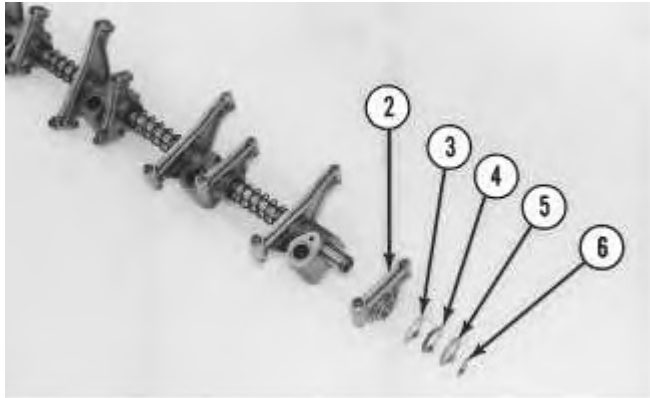

Illustration 2

g00490027

2. Remove retainer ring (6), washer (5), spring (4), washer (3) and rocker arm (2). Note the number of washers (3) that are used at both ends of the shaft. Remove rocker arms (2) from each end of the rocker shaft.



Illustration 3

g00449687

3. Remove the pin from the rear rocker shaft support (7) with a hammer and a suitable punch. Remove rear rocker shaft support (7).
4. Remove the remaining rocker arms, springs, washers and rocker shaft supports.
5. Remove the plugs from each end of the shaft, if necessary.

[Previous Screen](#)

Product: EXCAVATOR

Model: 330B L EXCAVATOR 3YR

Configuration: 330B L, 330B LN Excavators 3YR00001-UP (MACHINE) POWERED BY 3306 Engine

## Disassembly and Assembly 3304B and 3306B Engines for Caterpillar Built Machines

Media Number -SEN5598-09

Publication Date -01/01/2013

Date Updated -25/01/2013

i01138110

# Rocker Shaft - Assemble

SMCS - 1102-016

## Assembly Procedure

---

### NOTICE

**Keep all parts clean from contaminants.**

**Contaminants may cause rapid wear and shortened component life.**

---

---

### NOTICE

**Care must be taken to ensure that fluids are contained during performance of inspection, maintenance, testing, adjusting and repair of the product. Be prepared to collect the fluid with suitable containers before opening any compartment or disassembling any component containing fluids.**

**Refer to Special Publication, NENG2500, "Caterpillar Tools and Shop Products Guide" for tools and supplies suitable to collect and contain fluids on Caterpillar products.**

**Dispose of all fluids according to local regulations and mandates.**

---

---

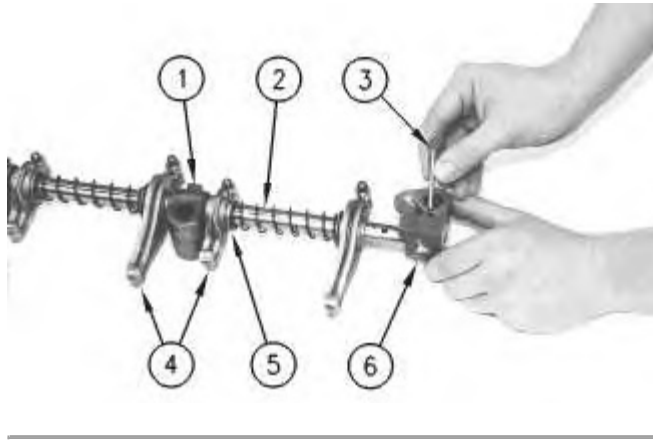

Illustration 1

g00449863

1. Install rocker arms (4), supports (1), washer (5) and springs (2) on the rocker shaft.
2. Install rear rocker shaft support (6) on the rocker shaft. Ensure that the hole in the rear rocker shaft support is aligned with the hole in the rocker shaft.
3. Install pin (3) through the rocker shaft support and the rocker shaft with a hammer.
4. Pin (3) must extend 9.60 mm (.378 inch) above the rocker shaft support.

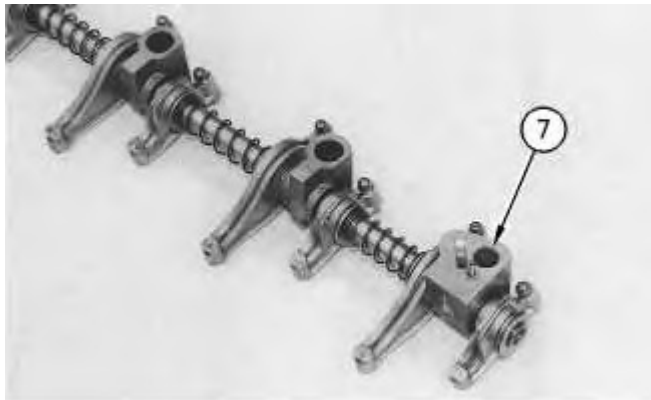
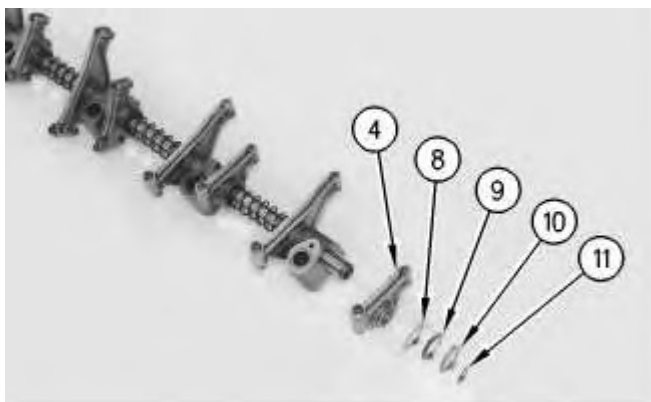

Illustration 2

g00449625



5. Install O-ring seal (7). Install rocker arm (4), washer (8), springs (9), washer (10) and retainer ring (11) .

**Note:** Make sure that the correct number of washers (8) are installed on the shaft.

6. Install the plugs in each end of the rocker shaft if the plugs were removed.

**End By:** Install the rocker shaft and pushrods. Refer to Disassembly and Assembly, "Rocker Shaft and Pushrods - Install".

[Previous Screen](#)

Product: EXCAVATOR

Model: 330B L EXCAVATOR 3YR

Configuration: 330B L, 330B LN Excavators 3YR00001-UP (MACHINE) POWERED BY 3306 Engine

## Disassembly and Assembly 3304B and 3306B Engines for Caterpillar Built Machines

Media Number -SEN5598-09

Publication Date -01/01/2013

Date Updated -25/01/2013

i07085956

## Rocker Shaft and Pushrod - Install

SMCS - 1102-012; 1208-012

### Installation Procedure

---

#### NOTICE

**Keep all parts clean from contaminants.**

**Contaminants may cause rapid wear and shortened component life.**

---

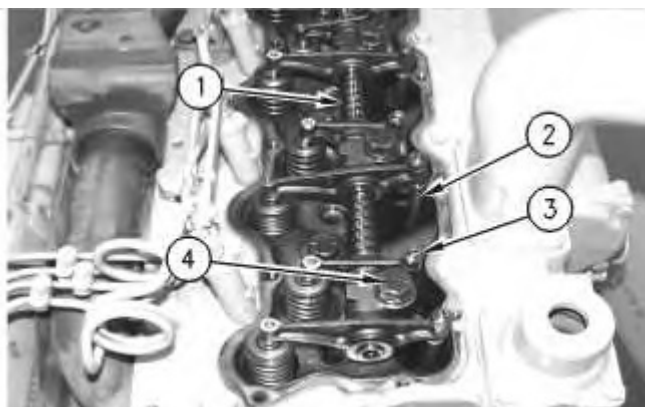

Illustration 1

g00539829

1. Loosen adjusting screws (3). This will prevent a bent valve or a bent pushrod during the installation of the rocker shaft assembly. Install pushrods (2) and ensure that the pushrods are seated in the valve lifters.

2. Install rocker shaft assembly (1) in position on the cylinder head.

---

### NOTICE

**Ensure that the dowels on each end of the rocker shaft assembly are in alignment with the holes in the cylinder head.**

---

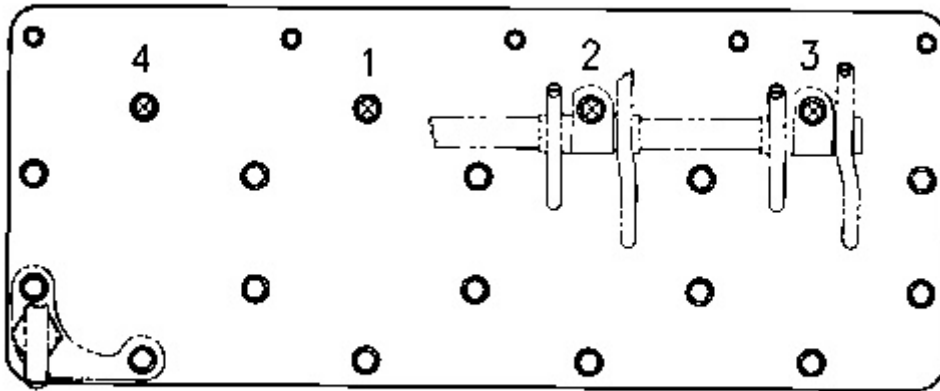

---

Illustration 2  
3304B torque sequence

g00591852

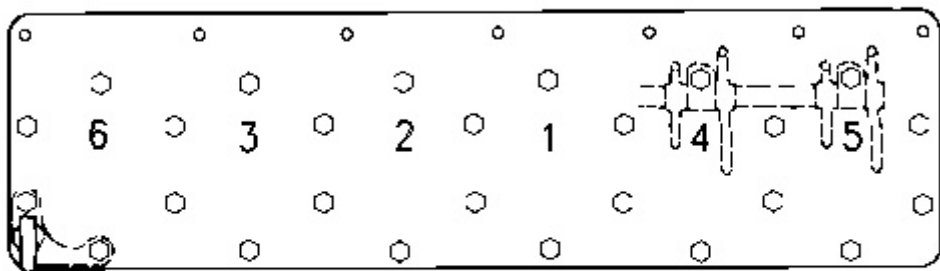

---

Illustration 3  
3306B torque sequence

g00544706

**Note:** Replace the O-ring seal when the bolt toward the rear of the engine is installed in the rocker shaft support.

3. Apply **6V-4876** Lubricant on the threads of six bolts (4) except for the bolt that passes through the rear rocker shaft support (bolt (6) in Illustration 3). Install six bolts (4) in the rocker shaft assembly.
4. Refer to Illustration 3. Tighten six bolts (4) for the rocker shaft, as follows:
  - a. Tighten all the bolts in the numerical sequence to a torque of 155 N·m (115 lb ft).
  - b. Tighten all the bolts in the numerical sequence to a torque of  $250 \pm 17$  N·m ( $185 \pm 13$  lb ft).
  - c. Tighten all the bolts again in the numerical sequence to a final torque of  $250 \pm 17$  N·m ( $185 \pm 13$  lb ft).
5. The assembled length of the springs at both ends of the rocker shaft must be  $1.50 \pm 0.25$  mm ( $.059 \pm .010$  inch). Remove the washers or install the washers behind the springs to change the assembled length of the springs.
6. Adjust the inlet valve lash to  $0.38 \pm 0.08$  mm ( $.015 \pm .003$  inch) and adjust the exhaust valve lash to  $0.64 \pm 0.08$  mm ( $.025 \pm .003$  inch). Refer to Testing and Adjusting, "Air Inlet and Exhaust System" for more information on setting the valve lash. Tighten the locknuts for the adjusting screws (3) to a torque of  $29 \pm 7$  N·m ( $21 \pm 5$  lb ft). Refer to Specifications, "Valve Rocker Arms and Lifters".

**End By:**

- a. Install the valve mechanism cover. Refer to Disassembly and Assembly, "Valve Mechanism Cover - Remove and Install".

[Previous Screen](#)

Product: EXCAVATOR

Model: 330B L EXCAVATOR 3YR

Configuration: 330B L, 330B LN Excavators 3YR00001-UP (MACHINE) POWERED BY 3306 Engine

## Disassembly and Assembly 3304B and 3306B Engines for Caterpillar Built Machines

Media Number -SEN5598-09

Publication Date -01/01/2013

Date Updated -25/01/2013

i00991114

# Cylinder Head - Remove

SMCS - 1100-011

## Removal Procedure

### Start By:

- A. Remove the fuel injection lines. Refer to Disassembly and Assembly, "Fuel Injection Lines - Remove and Install".
- B. Remove the exhaust manifold. Refer to Disassembly and Assembly, "Exhaust Manifold - Remove and Install".
- C. Remove the rocker shaft and pushrods. Refer to Disassembly and Assembly, "Rocker Shaft and Pushrods - Remove".

---

### NOTICE

**Keep all parts clean from contaminants.**

**Contaminants may cause rapid wear and shortened component life.**

---

---

### NOTICE

**Care must be taken to ensure that fluids are contained during performance of inspection, maintenance, testing, adjusting and repair of the machine. Be prepared to collect the fluid with suitable containers before opening any compartment or disassembling any component containing fluids.**

**Refer to Special Publication, NENG2500, "Caterpillar Tools and Shop Products Guide", for tools and supplies suitable to collect and contain fluids in Caterpillar machines.**

**Dispose of all fluids according to local regulations and mandates.**

---

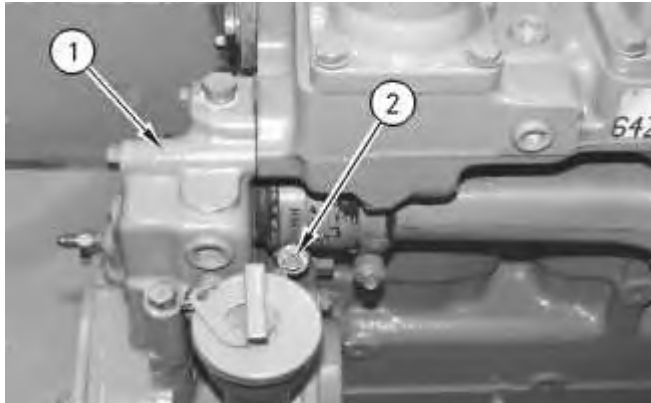

Illustration 1

g00505124

1. Loosen hose clamp (2) on the hose that connects the oil cooler to water pump elbow (1) .

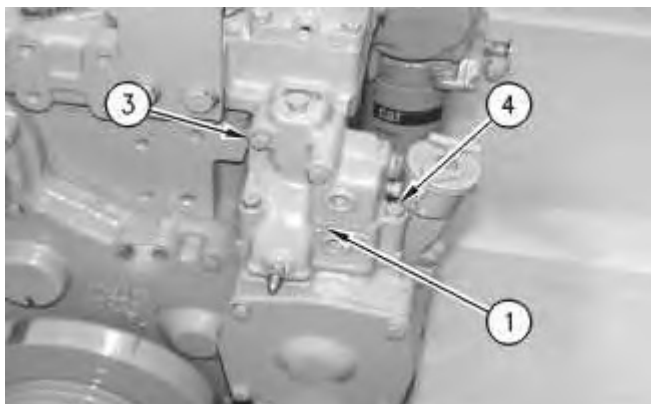

Illustration 2

g00505164

2. Remove two bolts (3) that fasten water pump elbow (1) to the cylinder head. Remove two bolts (4) that fasten water pump elbow (1) to the water pump.
  3. Carefully remove water pump elbow (1) and the gaskets from the engine.
-

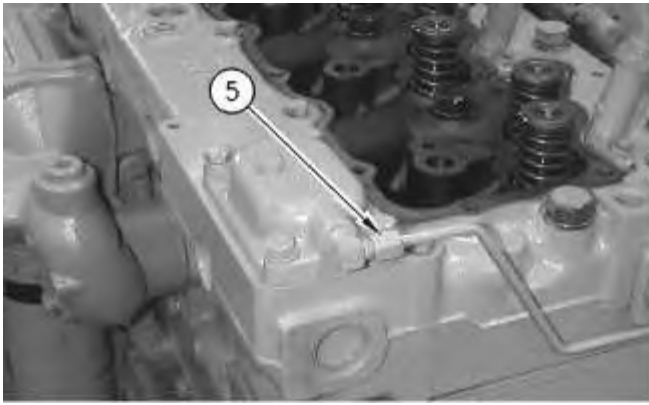

Illustration 3

g00538842

4. Disconnect tube (5) from the inlet manifold.

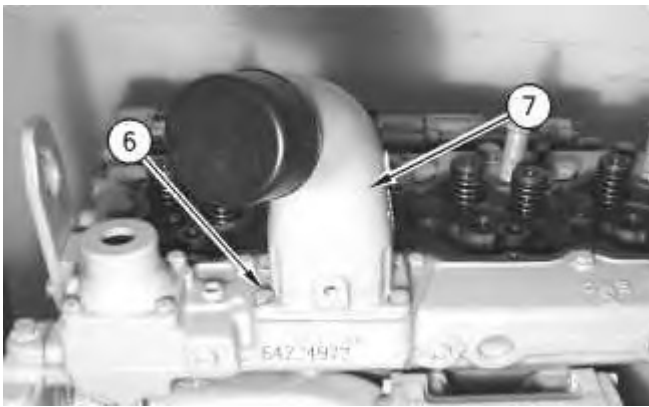

Illustration 4

g00538845

5. Remove four bolts (6) and remove air inlet pipe (7) .

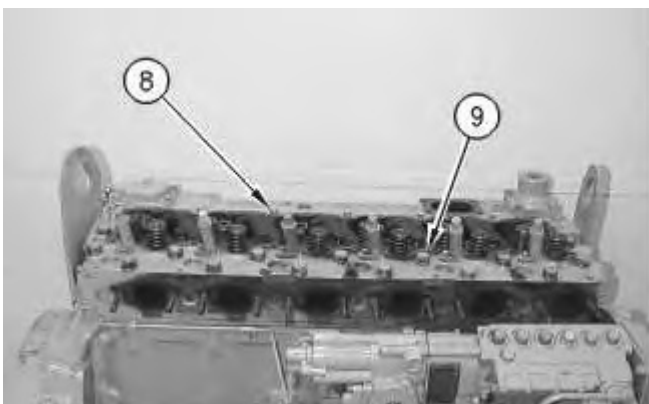

Illustration 5

g00541454

## NOTICE

**Do not set the cylinder head on a hard, flat surface. Damage may occur to the fuel injection nozzle tips.**

---

6. Remove all bolts (8) and (9) that hold the cylinder head to the cylinder block.

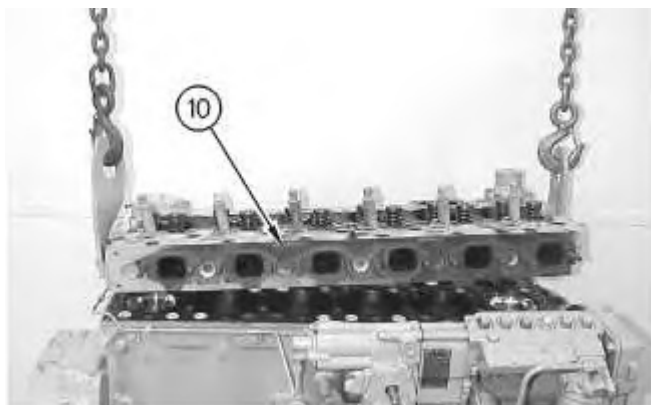

Illustration 6

g00505311

7. Attach the proper lifting device in order to remove cylinder head (10) from the engine. Remove cylinder head (10) from the engine. The weight of cylinder head (10) is approximately 95 kg (210 lb).

[Previous Screen](#)

Product: EXCAVATOR

Model: 330B L EXCAVATOR 3YR

Configuration: 330B L, 330B LN Excavators 3YR00001-UP (MACHINE) POWERED BY 3306 Engine

## Disassembly and Assembly 3304B and 3306B Engines for Caterpillar Built Machines

Media Number -SEN5598-09

Publication Date -01/01/2013

Date Updated -25/01/2013

i07489822

# Cylinder Head - Install

SMCS - 1100-012

## Installation Procedure

---

### NOTICE

**Keep all parts clean from contaminants.**

**Contaminants may cause rapid wear and shortened component life.**

---

**Note:** When the cylinder head is removed, a new spacer plate gasket must be installed. Refer to Disassembly and Assembly, "Spacer Plate - Remove and Install".

1. Ensure that the surface of the cylinder head is clean and dry. Install a new dry cylinder head gasket onto the cylinder block.

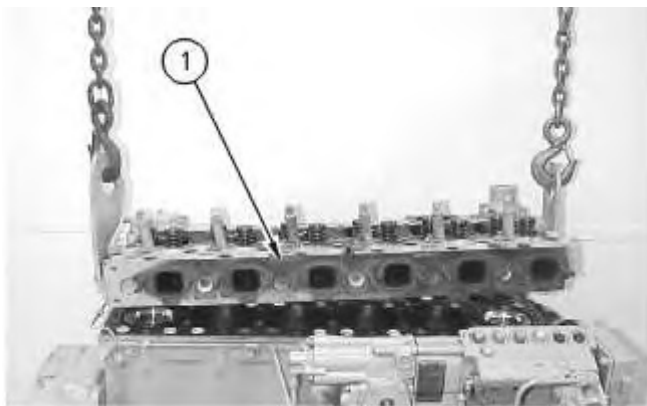

Illustration 1

g00541495

2. Fasten the proper lifting device to cylinder head (1). Put cylinder head (1) in position on the cylinder block. Remove the lifting device after cylinder head (1) is positioned.

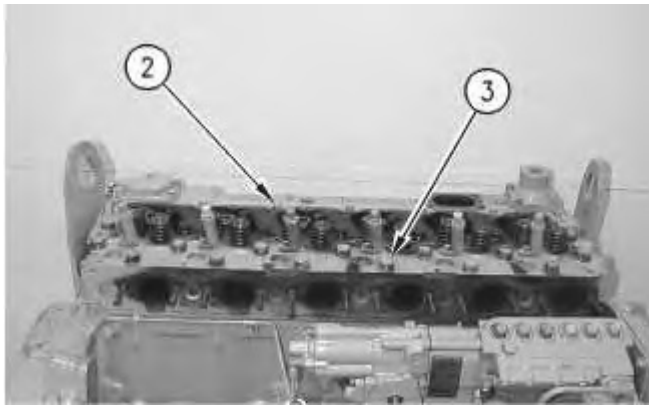

Illustration 2

g00541497

3. Apply clean engine oil to the threads and the washer faces of cylinder head bolts (2) and (3). Install cylinder head bolts (2) and (3). Tighten the cylinder head bolts finger tight.

**Note:** Do not tighten the cylinder head bolts at this time.



Illustration 3

g00511493

4. Install pushrods (4). Make sure that the pushrods are installed in the original location and that the pushrods are seated correctly in the valve lifters.
5. Loosen the adjusting screws on rocker arms (5) for valve clearance. This will prevent a bent valve or a broken pushrod during installation.
6. Install a new O-ring seal in the rear rocker arm support.
7. Apply clean engine oil to all the rocker shaft bolts except bolt (25). Refer to illustration 5.
8. Put rocker shaft assembly (5) in position on the cylinder head. Make sure that the dowels in the rocker shaft supports are aligned with the dowel holes in the cylinder head.
9. Ensure that the rocker arms are aligned with the pushrods and install the rocker shaft mounting bolts. Tighten the rocker shaft mounting bolts finger tight.

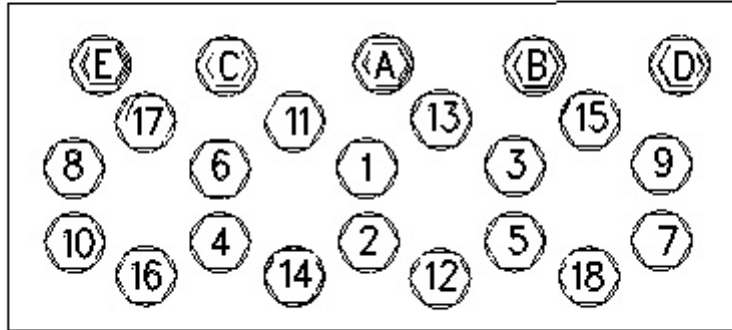

---

Illustration 4  
3304B torque sequence

g00602759

10. Tighten the cylinder head bolts by hand, as follows:
    - a. Tighten all the bolts (1 through 18) in the numerical sequence to a torque of  $150 \pm 15 \text{ N}\cdot\text{m}$  ( $115 \pm 12 \text{ lb ft}$ ).
    - b. Tighten all the bolts (1 through 18) again in the numerical sequence to a torque of  $250 \pm 17 \text{ N}\cdot\text{m}$  ( $185 \pm 13 \text{ lb ft}$ ).
    - c. Tighten all the bolts (1 through 18) again in the numerical sequence to a final torque of  $250 \pm 17 \text{ N}\cdot\text{m}$  ( $185 \pm 13 \text{ lb ft}$ ).
    - d. Tighten all the remaining bolts (A through E) to a torque of  $43 \pm 7 \text{ N}\cdot\text{m}$  ( $32 \pm 5 \text{ lb ft}$ ).
- 

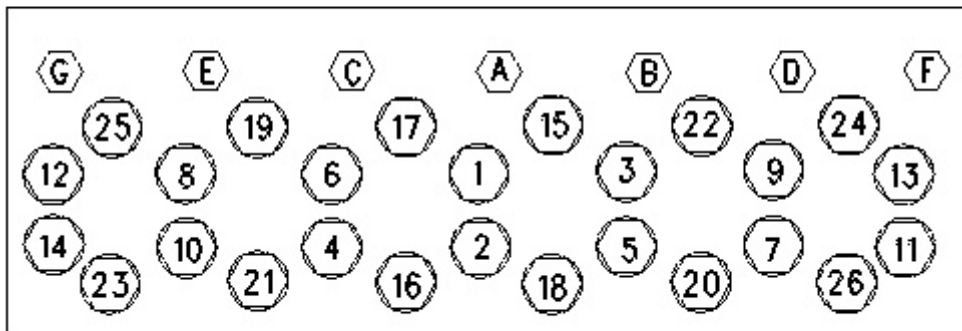

11. Tighten the cylinder head bolts by hand, as follows:
  - a. Tighten all the bolts (1 through 26) in the numerical sequence to a torque of  $150 \pm 15 \text{ N}\cdot\text{m}$  ( $115 \pm 12 \text{ lb ft}$ ).
  - b. Tighten all the bolts (1 through 26) in the numerical sequence to a torque of  $250 \pm 17 \text{ N}\cdot\text{m}$  ( $185 \pm 13 \text{ lb ft}$ ).
  - c. Tighten all the bolts (1 through 26) again in the numerical sequence to a final torque of  $250 \pm 17 \text{ N}\cdot\text{m}$  ( $185 \pm 13 \text{ lb ft}$ ).
  - d. Tighten all the remaining bolts (A through G) to a torque of  $43 \pm 7 \text{ N}\cdot\text{m}$  ( $32 \pm 5 \text{ lb ft}$ ).
12. Adjust the inlet valve lash to 0.38 mm (.015 inch) and the exhaust valve lash to 0.64 mm (.025 inch). Tighten the locknuts for the adjusting screws to a torque of  $29 \pm 7 \text{ N}\cdot\text{m}$  ( $22 \pm 5 \text{ lb ft}$ ). Refer to the Testing and Adjusting, "Air Inlet and Exhaust System" topic for additional information on valve lash adjustments.

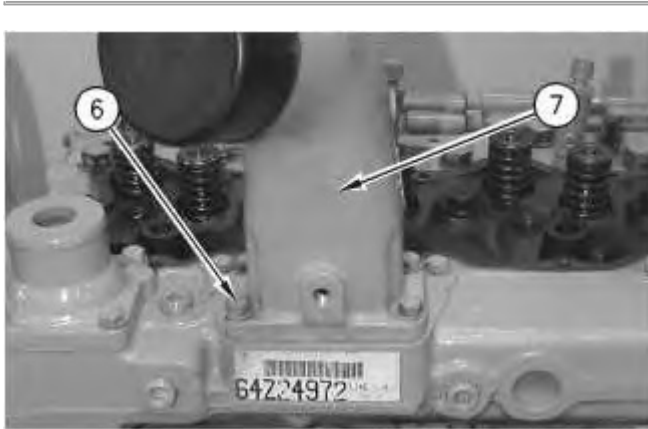

Illustration 6

g00511911

13. Put the gasket and air inlet pipe (7) in position on the cylinder head. Install four bolts (6) to fasten air inlet pipe (7) to the cylinder head.

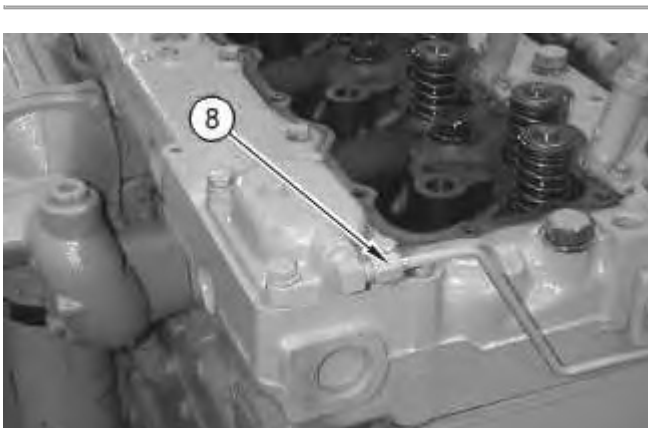

Illustration 7

g00541522

14. Connect tube (8) to the inlet manifold.

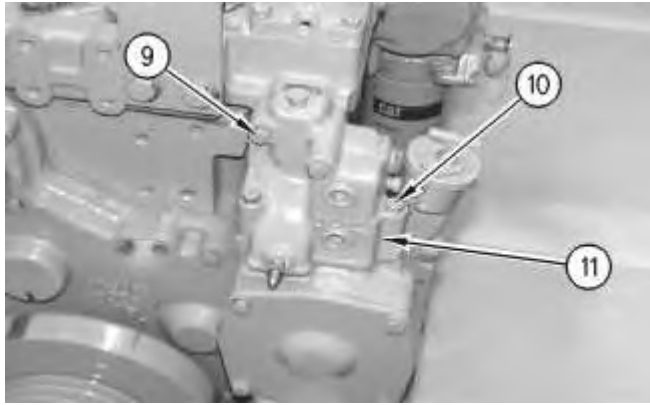

Illustration 8

g00541524

15. Put the gaskets and water pump elbow (11) in position on the engine. Install two bolts (9) that fasten water pump elbow (11) to the cylinder head. Install two bolts (10) that fasten water pump elbow (11) to the water pump.

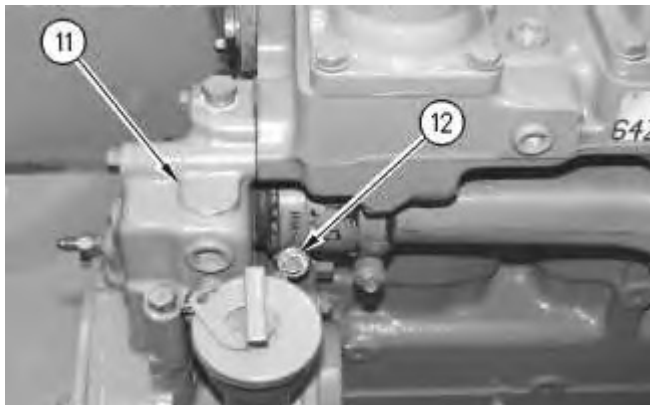

Illustration 9

g00541527

16. Tighten hose clamp (12).

**End By:**

- a. Install the valve mechanism cover. Refer to Disassembly and Assembly, "Valve Mechanism Cover - Remove and Install".
- b. Install the exhaust manifold. Refer to Disassembly and Assembly, "Exhaust Manifold - Remove and Install".
- c. Install the fuel injection lines. Refer to Disassembly and Assembly, "Fuel Injection Lines - Remove and Install".

[Previous Screen](#)

Product: EXCAVATOR

Model: 330B L EXCAVATOR 3YR

Configuration: 330B L, 330B LN Excavators 3YR00001-UP (MACHINE) POWERED BY 3306 Engine

## Disassembly and Assembly 3304B and 3306B Engines for Caterpillar Built Machines

Media Number -SEN5598-09

Publication Date -01/01/2013

Date Updated -25/01/2013

i01045029

# Spacer Plate - Remove and Install

SMCS - 1221-010

## Removal Procedure

### Start By:

- A. Remove the cylinder head. Refer to Disassembly and Assembly, "Cylinder Head - Remove".

---

### NOTICE

**Keep all parts clean from contaminants.**

**Contaminants may cause rapid wear and shortened component life.**

---

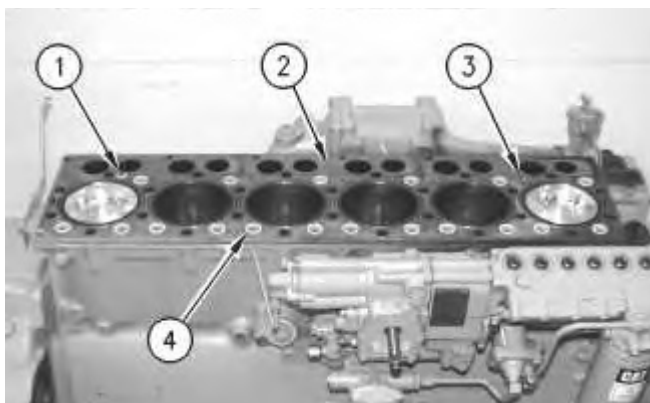

Illustration 1

g00540847

1. Remove O-ring seal (1), water seals (3) and water directors (4) from spacer plate (2) .

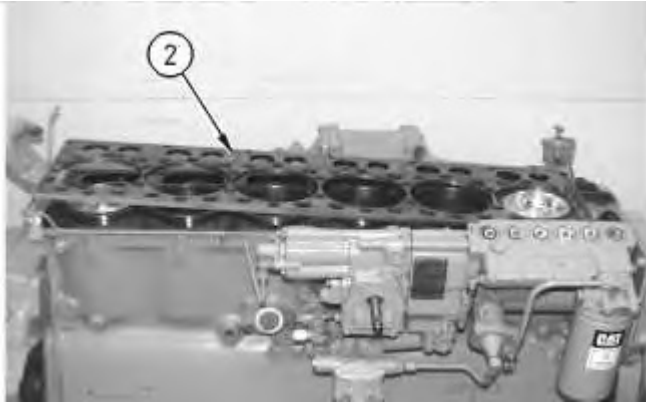

Illustration 2

g00540857

---

## NOTICE

**Do not damage the dowels as the spacer plate is removed.**

---

2. Remove spacer plate (2) from the cylinder head.

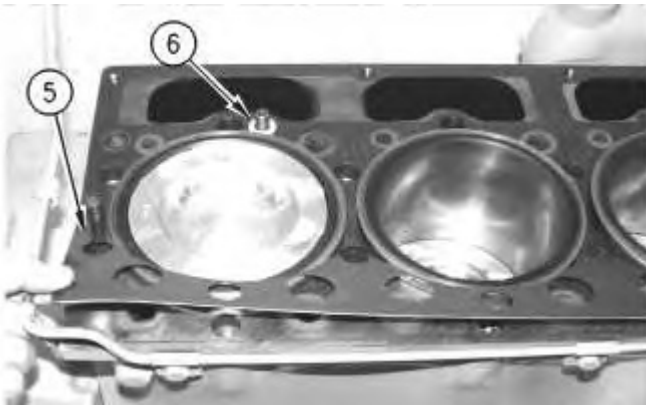

Illustration 3

g00540895

3. Remove O-ring seal (6) and spacer plate gasket (5) from the cylinder head.

## Installation Procedure

---



**Suggest:**

**If the above button click is invalid.**

**Please download this document first, and then click the above link to download the complete manual.**

**Thank you so much for reading**

## NOTICE

**Keep all parts clean from contaminants.**

**Contaminants may cause rapid wear and shortened component life.**

---

1. Thoroughly clean the mating surfaces between the spacer plate and the cylinder block.

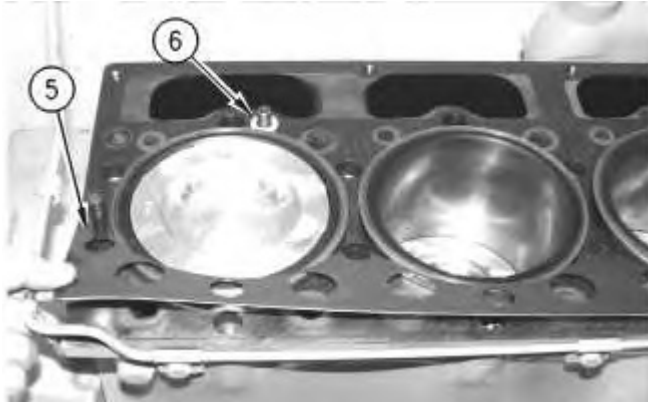

Illustration 4

g00540895

2. Install new spacer plate gasket (5) and new O-ring seal (6) .

**Note:** If the dowels in the cylinder block have been removed for any reason, the overall height of the installation is  $16.0 \pm 5.0$  mm ( $.63 \pm .20$  inch).

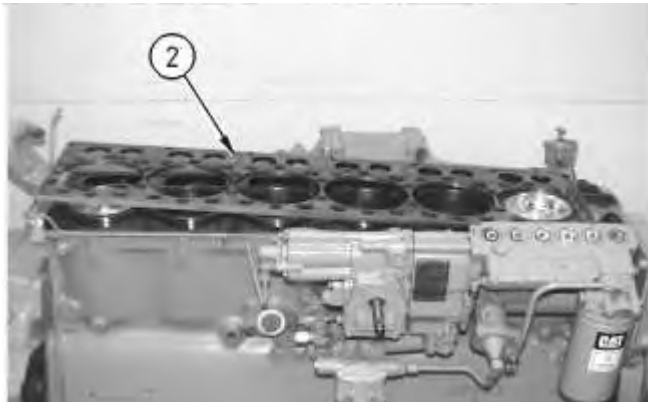

Illustration 5

g00540857

**Note:** Both surfaces of the spacer plate, spacer plate gasket and the top of the cylinder block must be clean and dry. Do not use any gasket adhesive or other substances on these surfaces.

**<https://www.ebooklibonline.com>**

Hello dear friend!

Thank you very much for reading.

Enter the link into your browser.

The full manual is available for immediate download.

**<https://www.ebooklibonline.com>**