

5730 and 5830 Self Propelled Forage Harvesters



JOHN DEERE

TECHNICAL MANUAL 5730 and 5830 Self Propelled Forage Harvesters

TM1352 (03DEC93) English

John Deere Ottumwa Works
TM1352 (03DEC93)

LITHO IN U.S.A.
ENGLISH



Contents

SECTION 10—GENERAL

- Group 05—Safety
- Group 10—Specifications, Torques, and Special Tools
- Group 15—Tune-Up
- Group 20—Engine Removal

SECTION 20—ENGINE REPAIR (6466A)

SECTION 25—ENGINE REPAIR (6619A)

- Group 00—Specifications and Special Tools
- Group 05—Cylinder Head, Valves and Camshaft
- Group 10—Cylinder Block, Liners Pistons, and Rod
- Group 15—Crankshaft, Main Bearings, and Flywheel
- Group 20—Lubrication System
- Group 25—Cooling System

SECTION 30—FUEL AND AIR REPAIR

- Group 05—Air Intake System
- Group 10—Diesel Fuel System

SECTION 40—ELECTRICAL REPAIR

- Group 05—Battery Repair
- Group 10—Charging Circuit Repair
- Group 15—Starting Circuit Repair
- Group 20—Electrical Component Repair
- Group 25—Harness Repair
- Group 30—Metal Detector Repair
- Group 35—Rotary Screen Motor Repair
- Group 40—SPOUT-TRAK™ Repair

SECTION 50—POWER TRAIN

- Group 05—Hydrostatic Fitting Torques
- Group 10—Flushing Hydrostatic System
- Group 15—Hydrostatic Drive Repair
- Group 20—Transmission Repair
- Group 25—Differential Repair
- Group 30—Final Drive Repair
- Group 35—Cam Lobe Motor Repair
- Group 40—Power Rear Wheel Control Valve

SECTION 60—STEERING AND BRAKES REPAIR

- Group 05—Steering Unit Repair
- Group 10—Steering Cylinder and Tie Rod Repair
- Group 15—Brake Repair
- Group 20—Master Cylinder Repair
- Group 25—Slave Cylinder Repair

SECTION 70—HYDRAULIC REPAIR

- Group 05—Torque Hydraulic Fittings
- Group 10—Flushing the Hydraulic System
- Group 15—Hydraulic Reservoir
- Group 20—Knife Sharpener Motor Repair
- Group 25—Knife Sharpener Selector Valve Repair
- Group 30—Gear Case Cooling Pump Repair
- Group 35—Main Hydraulic Pump Repair
- Group 40—Priority and Relief Valves
- Group 45—Hydraulic Outlet
- Group 50—Harvesting Unit Lift Cylinder
- Group 55—Belt Tightener Cylinder
- Group 60—Spout Control Motor Repair
- Group 65—Electrohydraulic Valves

SECTION 80—MACHINE FUNCTIONS

- Group 05—Diagnosing malfunctions
- Group 10—Feed Roll Repair
- Group 15—Stationary Knife Adjuster Repair
- Group 20—Remove Roll Arm Repair
- Group 25—Cutterhead Knife Bracket
- Group 30—Cutterhead Repair
- Group 35—Knife Sharpener Repair
- Group 40—Feed Roll Gear Case Repair
- Group 45—Auger Repair
- Group 50—Fan and Spout Repair
- Group 55—Main Clutch Repair
- Group 60—Main Gear Case Repair

SECTION 90—OPERATOR'S STATION REPAIR

- Group 05—Pressurizer System
- Group 10—Air Conditioning System
- Group 15—Cab Removal
- Group 20—Heating System
- Group 25—Personal Posture™ Seat

Continued on next page

All information, illustrations and specifications in this manual are based on the latest information available at the time of publication. The right is reserved to make changes at any time without notice.

TM1352-19-03DEC93

COPYRIGHT® 1993
DEERE & COMPANY
Moline, Illinois
All rights reserved
A John Deere ILLUSTRATION® Manual
Previous Editions
Copyright® 1986 Deere & Company

10

Group 30—Miscellaneous Component

**SECTION 290—OPERATOR'S STATION
OPERATION AND TESTS**

Group 05—Diagnosing Malfunctions
Group 10—Pressurizer System
Group 15—Air Conditioning System Operation
Group 20—Air Conditioning System Tests and
Diagnosis

SECTION 100—KERNEL PROCESSOR REPAIR

Group 05—Kernel Processor

20

**SECTION 220—ENGINE OPERATION AND TESTS
(6466A)**

Group 05—System Operation
Group 10—System Operation and Tests

25

**SECTION 225—ENGINE OPERATION AND TESTS
(6619A)**

Group 05—System Operation
Group 10—System Tests And Diagnosis

30

**SECTION 230—FUEL/AIR OPERATION AND
TESTS**

Group 05—Air Intake System
Group 10—Diesel Fuel System

40

**SECTION 240—ELECTRICAL OPERATION AND
TESTS**

Group 05—Battery Testing
Group 10—Charging Circuit Diagnosis
Group 15—Starting Circuit Diagnosis
Group 20—Electrical Testing
Group 25—General Wiring Diagrams
Group 30—Iron Gard™ Metal Detector Diagnosis
Group 35—Rotary Air Screen Diagnosis
Group 40—Spout-Trak™ Diagnosis
Group 45—Electric Clutch Diagnosis

50

60

**SECTION 250—POWER TRAIN OPERATION AND
TESTS**

Group 05—Diagnosing Power Train Malfunctions
Group 10—Power Train Operation and Tests
Group 15—Power Rear Wheel Drive Operation
and Tests

70

80

SECTION 260—STEERING/BRAKES OPERATION

Group 05—Steering
Group 10—Brakes

90

**SECTION 270—HYDRAULIC OPERATION AND
TESTS**

Group 05—Diagnosing Malfunctions
Group 10—Hydraulic System Operation
Group 15—Electrohydraulic Valve Operation
Group 20—Hydraulic Diagrams
Group 25—Hydraulic System Tests

<https://www.ebooklibonline.com>

Hello dear friend!

Thank you very much for reading.

Enter the link into your browser.

The full manual is available for immediate download.

<https://www.ebooklibonline.com>

Section 10 GENERAL

CONTENTS

	Page	Page
GROUP 05—SAFETY		
GROUP 10—SPECIFICATIONS, TORQUES, AND SPECIAL TOOLS		
Engine	10-10-1	
Hydrostatic System (Ground Drive)	10-10-2	
Lubrication System	10-10-2	
Fuel System	10-10-2	
Cooling System	10-10-2	
Electrical System	10-10-2	
Main Clutch (Blower Fan and Cutterhead Drive)	10-10-3	
Transmission	10-10-3	
Final Drive	10-10-3	
Weight (Less Harvesting Unit)	10-10-3	
Cutterhead	10-10-4	
Cutterhead Reverse Grinder	10-10-4	
Blower	10-10-4	
Augers (All Countries Except Europe)	10-10-4	
Augers (Europe)	10-10-4	
Power Rear Wheel Drive (Optional)	10-10-4	
Hydraulic System (Machine Functions)	10-10-5	
Brakes	10-10-5	
Operator's Cab	10-10-5	
Tire Options	10-10-5	
Maximum Ground Speed	10-10-6	
Capacities	10-10-7	
Dimensions	10-10-8	
English Torque Specifications	10-10-9	
Metric Torque Specifications	10-10-9	
GROUP 15—TUNE-UP		
Special Tools	10-15-1	
Other Materials	10-15-1	
General	10-15-2	
Preliminary Engine Testing	10-15-2	
Remove and Inspect Air Cleaner Elements	10-15-2	
Cleaning Primary Element	10-15-3	
Washing Primary Element	10-15-3	
Inspecting Primary Element	10-15-4	
Tighten Air Intake Connection	10-15-4	
Check Air Intake Restriction	10-15-5	
Clean Crankcase Vent Tube (5830)	10-15-5	
Cleaning the Radiator Condenser, Oil Cooler, and Vacuum Ducts	10-15-6	
Clean Rotary Screen	10-15-6	
Yearly Cooling System Flush	10-15-7	
Engine Coolant-Conditioner Filter	10-15-9	
Test Radiator and Cap.	10-15-9	
Adjust Alternator Belt	10-15-11	
Adjust Compressor Belt	10-15-12	
Check Fuel Filters	10-15-12	
Bleed Fuel System	10-15-12	
Check and Adjust Injection Pump Timing	10-15-13	
Check and Adjust Slow and Fast Idle Speeds	10-15-14	
Service Battery	10-15-14	
Make Final Engine Test	10-15-15	
Miscellaneous Checks	10-15-16	
GROUP 20—ENGINE REMOVAL		
Fabricated Tools	10-20-1	
Remove Engine	10-20-1	
Repair Engine	10-20-7	
Install Engine	10-20-7	
Remove Rotary Air Screen	10-20-8	

SAFETY AND YOU

This is the safety-alert symbol. When you see this symbol on the machine or in this manual, be alert to the potential for personal injury .



AB6;T81389 053;TMSAFE 071085

IMPORTANT

The **IMPORTANT** message identifies potential problems which may cause consequential damage to machine. Following recommended procedure will instruct technician how to avoid problem.

E03;;1005 V 190686

NOTES

The word *NOTE* is followed by a statement that identifies a qualification or exception to a previous statement. A "NOTE" may also identify nice-to-know information pertinent to, but not directly related to previous statement.

U10;010INT E 101281

KEEP RIDERS OFF MACHINE

Only allow the operator on the machine. Keep riders off.

Riders on machine are subject to injury such as being struck by foreign objects and being thrown off of the machine. Riders also obstruct the operator's view resulting in the machine being operated in an unsafe manner.



AB6;TS173 053;RIDER 261184

OBSERVE SAFETY RULES



This safety alert symbol identifies important safety messages in this manual and on the machine. When you see this symbol, be alert to the possibility of personal injury and carefully read the message that follows.

Avoid loose clothing that can catch in moving parts and put you out of work.

Wear your safety glasses while on the job.

Avoid working on equipment with the engine running. If it is necessary to make checks with the engine running, ALWAYS USE TWO PEOPLE—with the operator, at the controls, able to see the person doing the checking. Also, place the transmission in neutral and set the brake. KEEP HANDS AWAY FROM MOVING PARTS.

Keep transmission and brake control units properly adjusted at all times. Before making adjustments, stop engine.

Before removing any housing covers, stop engine. Take all objects from your pockets which could fall into the opened housings. Don't let adjusting wrenches fall into opened housings.

Don't attempt to check belt tension while the engine is running.

Don't adjust the fuel system while the machine is in motion.

Before repairing the electrical system, or performing a major overhaul, make sure the batteries are disconnected.



T27999H

0A9;T27999 E03;0000 J 210383

WEAR PROTECTIVE CLOTHING

Wear fairly tight clothing. and safety equipment.



AB6;TS184 053;WEAR2 080785

GENERAL

Before tuning up a harvester, determine whether a tune-up will restore operating efficiency. When there is doubt, the following preliminary tests will help determine if the engine can be tuned up. If the condition is satisfactory, proceed with the tune-up. Choose from the following procedures only those necessary to restore the unit.

0A9; E03;1015 A 260282

PRELIMINARY ENGINE TESTING

Operation	Specification	Section-Group Reference
Dynamometer Test—2100 engine rpm or 1020 rpm at cutterhead drive sheave	Compare with previous recorded output record and compare with output after tune-up	220-225
Compression Test	2275 to 2551 kPa (22.7 to 25.5 bar) (330 to 370 psi) at 200 to 250 rpm (5730) 2275 to 2620 kPa (22.7 to 26.2 bar) (330 to 380 psi) at 200 to 250 rpm (5830)	220-225

E03;;1015 AA 140187

REMOVE AND INSPECT AIR CLEANER ELEMENTS

1. Remove primary element (A) by removing wing nut (B). Wipe inside of canister with a clean cloth.
2. Remove secondary element (C) ONLY if it is to be replaced. Do not attempt to clean secondary element.

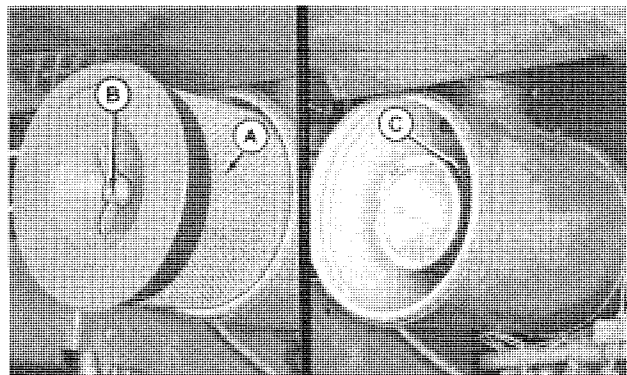

0A9;E28033 E03;;1015 AB 200686

CLEANING PRIMARY ELEMENT

1. Pat sides of element gently to loosen dirt. Do not tap element against a hard surface.



CAUTION: Wear proper eye protection.

2. Using a John Deere AR62377 Dry Element Cleaner Gun, clean element with compressed air. Hold nozzle next to inner surface, and move up and down pleats directing air blast away from self and others.

IMPORTANT: Do not exceed 30 psi (200 kPa) (2.1 bar) air pressure. Do not direct air against outside of element, as it might force dirt through to inside.

3. Repeat steps 1 and 2 to remove additional dirt. Inspect element before reinstalling.

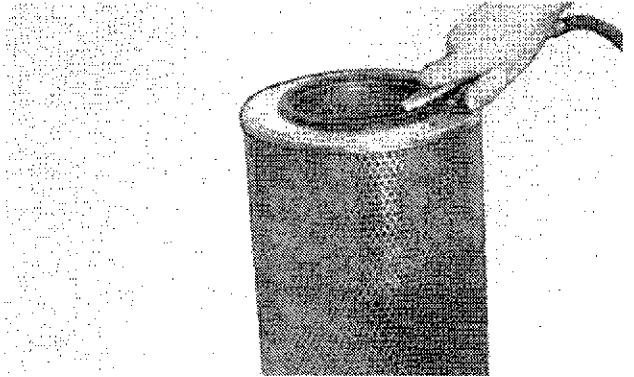
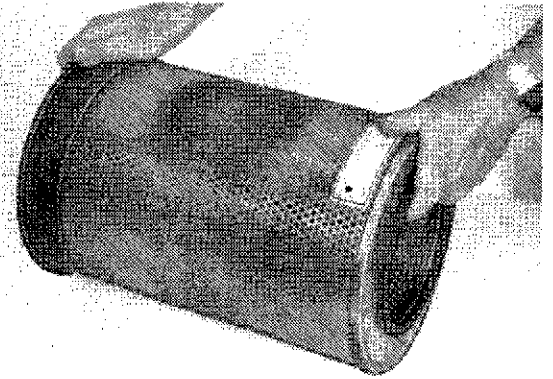

AA8;E21929 E21930 E03;;583EG AB 130585

WASHING PRIMARY ELEMENT

IMPORTANT: Never wash element in gasoline or any solvent. Never use compressed air on a wet element. Do not oil element.

1. If element is coated with oil or soot, wash in a solution of warm water and John Deere R36751 Filter Element Cleaner or its equivalent. Let element soak at least 15 minutes, then agitate gently to flush out dirt.

2. Rinse element thoroughly from inside with clean water. Use element cleaning gun or a free-running hose. Keep pressure low to avoid damaging element.

3. Allow element to dry completely before using. This usually takes from one to three days. Do not oven dry or use drying agents. Protect element from freezing until dry. Inspect element before reinstalling.

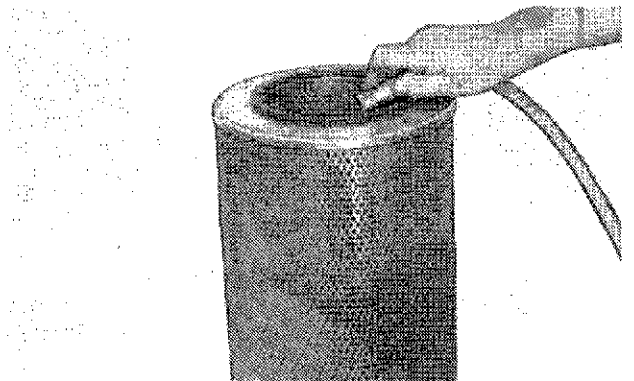

AA8;E21931 E03;;583EG AC 130585

INSPECTING PRIMARY ELEMENT

1. Hold a bright light inside element and check carefully for holes. Discard any element which shows the slightest hole.

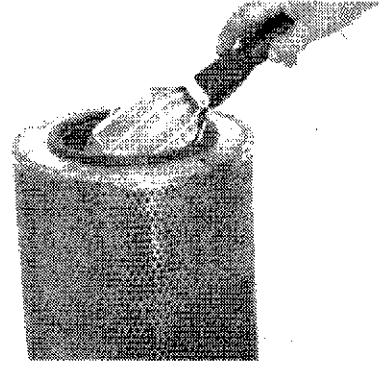

AA8;E21932 E03;;583EG AD 130585

2. Be sure outer screen (arrowed) is not dented. Vibration would quickly wear a hole in filter.
3. Be sure filter gasket (arrowed) is in good condition. If gasket is damaged or missing, replace element.
4. Seal element in a plastic bag and store in shipping container to protect against dust and damage.
5. Replace element when service interval becomes short. Replace both primary and secondary elements at least once a year.

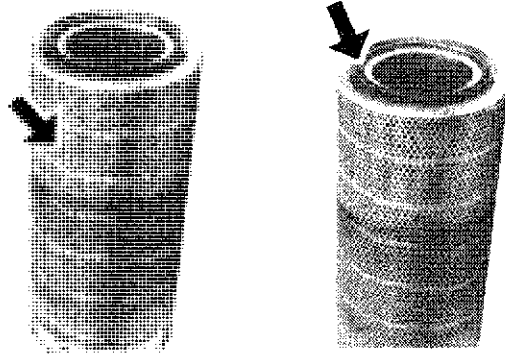

AA8;R29647 R29648 E03;;583EG AE 130585

TIGHTEN AIR INTAKE CONNECTIONS

1. Tighten air intake connections at air cleaner (A) to 8.5 N·m (6 lb-ft) torque.
2. Inspect exhaust system for leaks or restrictions.

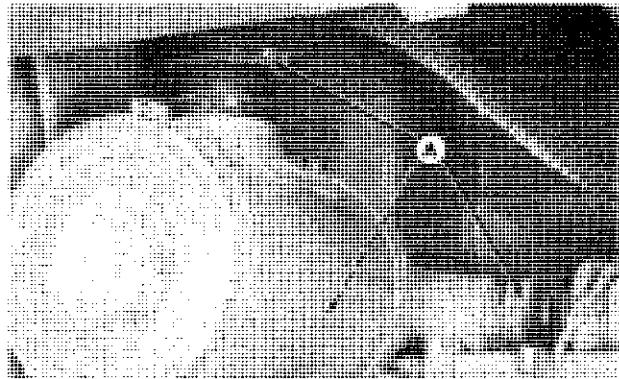

0A9;E28009 E03;;1015 AC 200686

CHECK AIR INTAKE RESTRICTION

1. Remove air restriction switch (A).
2. Install a restriction indicator tee fitting into opening. Install restriction indicator on one end of tee and add D-05022ST water vacuum gauge on other end.
3. Start engine and slowly cover air intake pipe.
4. Observe reading on water vacuum gauge. Restriction indicator must show red when water vacuum gauge reads 5.6 to 6.8 kPa (56 to 68 mbar) (22.5 to 27.5 in.) of water.
5. Remove water vacuum gauge, restriction switch, and tee fitting. Install switch.
6. Torque sending unit to 10 N·m (8 lb-ft).

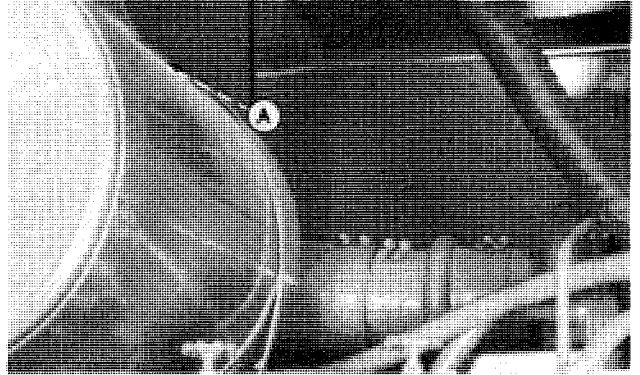

0A9;E27180 E03;;1015 AD 200686

CLEAN CRANKCASE VENT TUBE (5830)

1. Remove and clean crankcase vent tube (A).

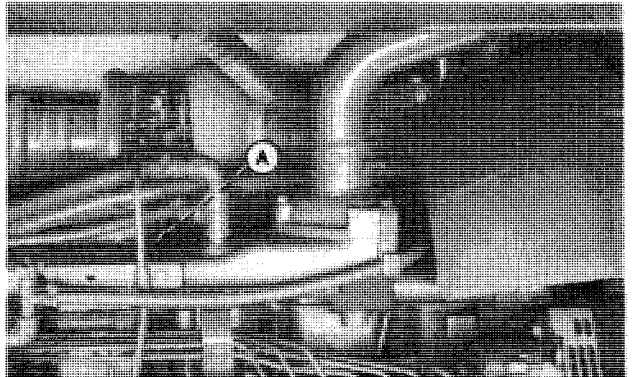

0A9;E28010 E03;;1015 AE 200686

CLEANING THE RADIATOR CONDENSER, OIL COOLERS, AND VACUUM DUCTS

CAUTION: Always shut off engine and ignition switch before servicing rotary air screen. Avoid bodily injury from rotary knife. Keep hands out of door duct when screen is turning.

IMPORTANT: Alarm will sound and indicators will glow when the radiator, hydrostatic cooler, and/or main gear case cooler become clogged with dirt and fluid overheats. Stop harvester, shut off engine, and clean screens, radiator, and coolers.

1. Open rotary air screen door or remove stationary screen (by removing two bolts).
2. Remove chaff and dirt from condenser (A), coolers (B) and (C), and vacuum ducts (D) and (G).
3. Unfasten condenser latch (E), condenser will swing open.
4. Unfasten two latches (F) on hydrostatic oil cooler and pull out hydrostatic cooler and main gear case cooler.
5. Clean coolers and radiator core.
6. Straighten bent fins.

A—Condenser
B—Cooler
C—Cooler
D—Vacuum Duct
E—Latch
F—Latches
G—Vacuum Duct

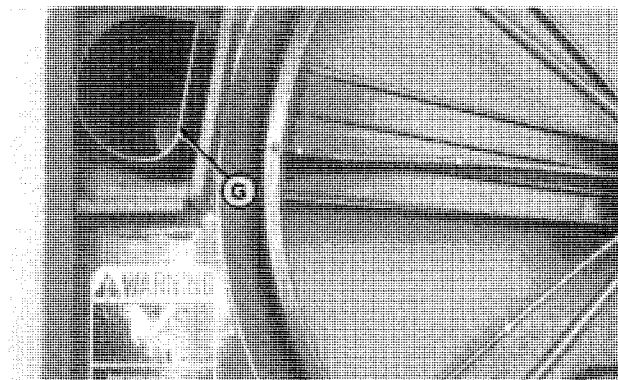
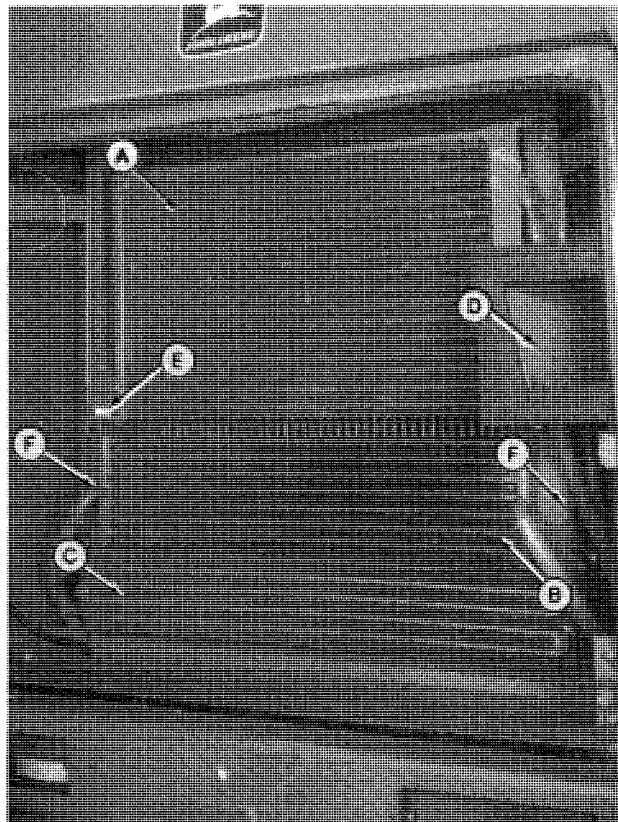

AA8;E26398 E26399 E03;;583EG U 130585

CLEAN ROTARY SCREEN

1. Clean the rotary screen with a brush or compressed air when dirt and chaff accumulate on or behind the screen.
2. To clean with compressed air, open door and blow from the inside of screen out.

E03;;1015 AF 200686

YEARLY COOLING SYSTEM FLUSH

Drain, flush, and refill system annually. Replace thermostats every two years.

1. Remove radiator cap.
2. Open the drains on the engine block (A) and radiator. Be sure to drain coolant from engine oil cooler (B) on 5830 Forage Harvester only.
3. Disconnect upper water hose from the thermostat cover (C) and remove screws from cover.
4. Lift cover off and remove both thermostats.
5. Install cover and connect the upper water hose.
6. Close the radiator and engine block drains. Fill the system with water. Install radiator cap.
7. Turn on the cab heater and run engine until it reaches operating temperature.
8. Stop engine and drain coolant before rust or sediment settles. Be sure to drain coolant from the engine oil cooler on 5830 Harvester only.
9. Close drains. Fill system with a solution of clean water and John Deere Cooling System Cleaner or its equivalent. Follow instructions provided with cleaner.
10. Flush system with water. Install filler cap and run the engine until it reaches operating temperature. Drain flushing water.
11. Remove thermostat cover and install thermostats. Install cover and connect upper water hose.

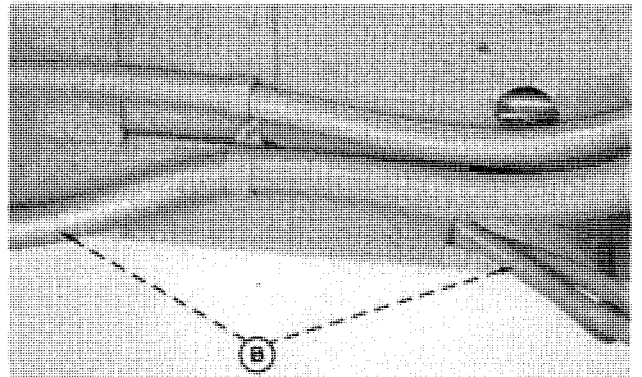
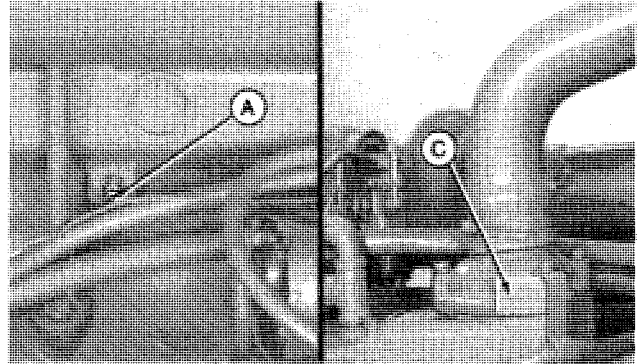

0A9;E21927 E26633 E03;;1015 AG 200686

IMPORTANT: Do not use methoxyl propanol antifreeze in the coolant solution. It may damage cylinder sleeves and seals. This antifreeze is also not compatible with either precharge or service filters.

12. Close drains and fill system. Use clean, soft water for a mixture of half water, half ethylene glycol-type antifreeze. (Some water contains impurities which may damage the cooling system.)

NOTE: 5830—Install a coolant filter (A) after cleaning system to charge the system with coolant conditioner. Change filter at 500 to 600 hour intervals. It is convenient to change coolant filter during every third oil filter change.

5730—The use of RE12842 Liquid Coolant Conditioner is recommended to protect against engine and cooling system wear. Add 2 L (2 qt) to radiator.

13. Recheck coolant level after starting the engine, being sure level is within 19 mm (3/4-in.) of bottom of filler neck. Add coolant if necessary to maintain this level.

14. After adding antifreeze, turn cab heater on and run engine until it reaches operating temperature. This opens the thermostats and mixes solution uniformly and circulates it through the entire system.

15. Cooling system capacity is 42 L (11 gal) for 5730 and 57 L (15 gal) for 5830.

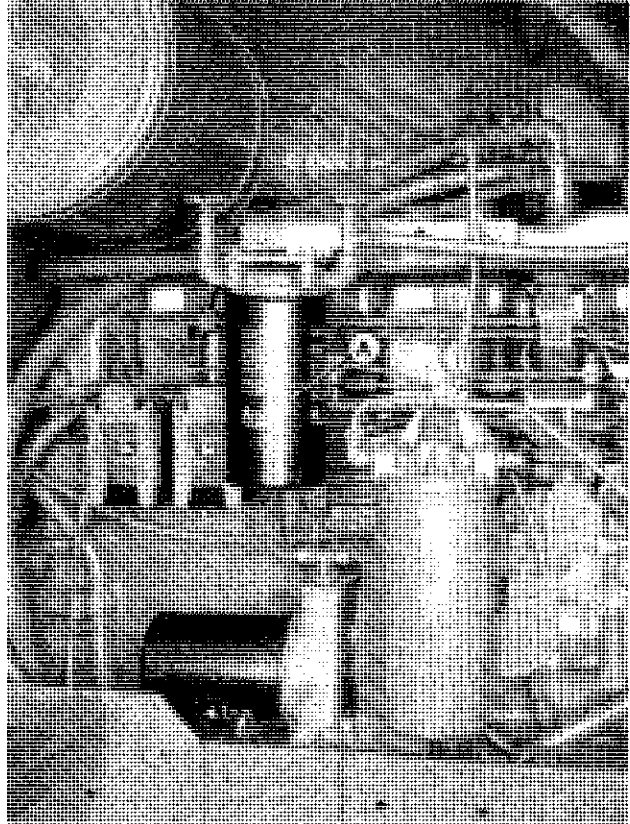

0A9;E26634 E03;;1015 AH 200686

ENGINE COOLANT-CONDITIONER FILTER

⚠ CAUTION: Do not loosen filter element (5830) when engine is hot.

1. Close shutoff valves (A).
2. Remove and discard filter element (B).
3. Lubricate filter gasket on new element with oil. Tighten element until it contacts base, then another 1/2 to 3/4 turn. Do not overtighten.
4. Open shutoff valves.
5. Check for leaks after starting engine.

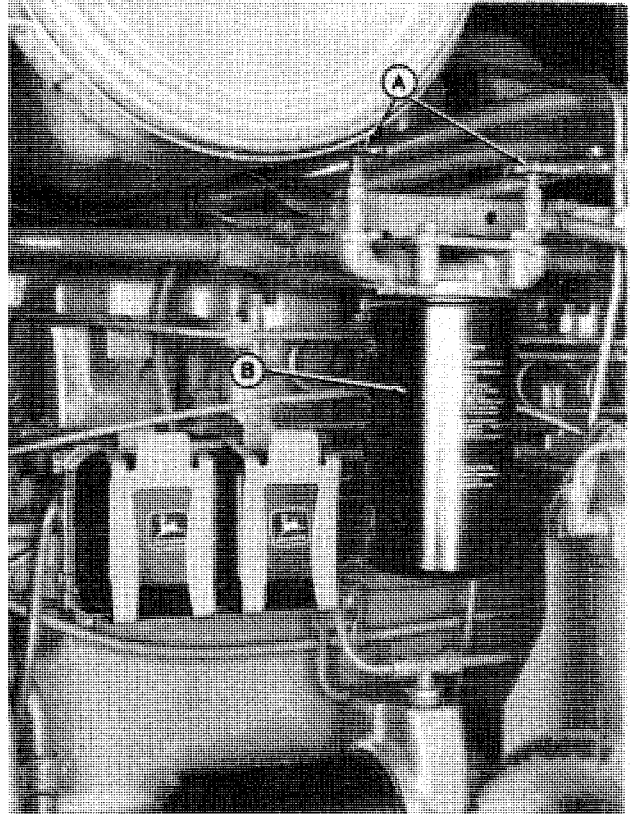

0A9;E28011 E03;;1015 AI 240986

TEST RADIATOR AND CAP

1. Remove radiator cap.
2. Visually check radiator for leaks or damage.
3. Disconnect overflow hose.
4. Plug hose using a cap screw and hose clamp.
5. Attach D-05104ST radiator tester to filler neck. Pressurize to 120 kPa (1.2 bar) (18 psi).
6. Repair system as necessary if pressure does not hold.

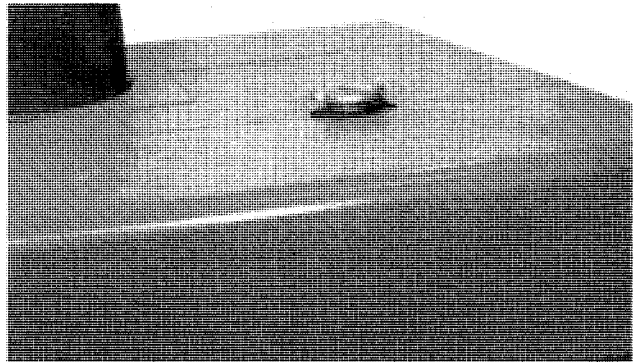

0A9;E21926 E03;;1015 AJ 200686

Tune-Up

7. Install radiator cap onto D-05104ST tester as shown.
8. Pressurize to 100-120 kPa (1.0-1.2 bar) (14-17 psi).
Replace cap if it does not hold pressure.

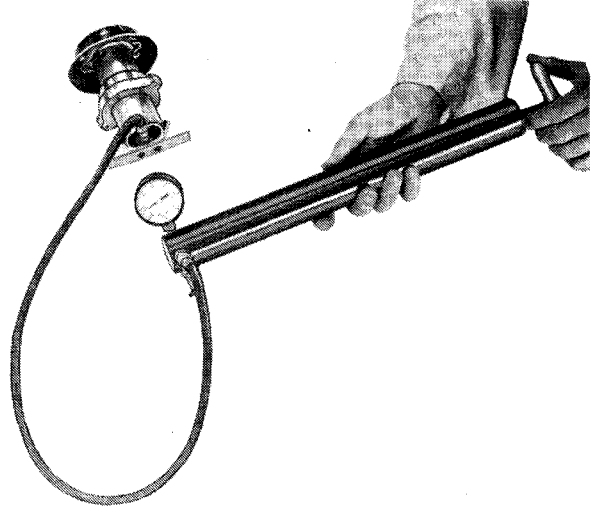

0A9;R26406 N E03;;1015 AW 240986

ADJUST ALTERNATOR BELT

IMPORTANT: Belts must be cool when tension is adjusted.

1. Be sure belt is in good condition.
2. Install JDG-138-1 Adapter (A) of JDG-138 Belt Tension Tool (B) over spacer. Install torque wrench (C) on adapter.
3. With alternator rotated inward toward cylinder block, slowly rotate alternator outward while reading torque wrench. Reading should be smooth and less than 27 N·m (20 lb-ft).

NOTE: If reading is erratic and more than 27 N·m (20 lb-ft) pivot points should be lubricated or cleaned.

4. Slowly increase the torque to specification and tighten adjusting cap screw (D). Torque specification tolerance is ± 4 N·m (3 lb-ft).

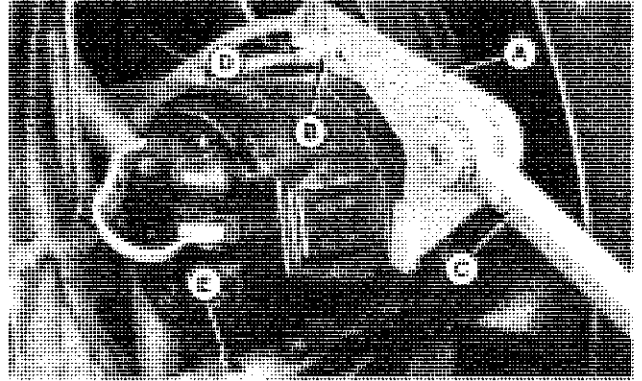

Alternator Belt	Torque
Used Belt	Initial torque reading +41 N·m (30 lb-ft)
New Belt	Initial torque reading +54 N·m (40 lb-ft)

IMPORTANT: Do not over-torque, then relax to correct specification. Friction will cause belt to be over-torqued.

5. Tighten mounting bolt (E).

- A—JDG-138-1 Adapter
- B—JDG-138 Belt Tension Tool
- C—Torque Wrench
- D—Cap Screw
- E—Mounting Bolt

ADJUST COMPRESSOR BELT

IMPORTANT: Belt must be cool when tension is adjusted.

1. Loosen adjusting cap screw.
2. Rotate compressor toward engine, install JDG-138-1 Adapter (A) and torque wrench.
3. Slowly rotate compressor outward while reading torque wrench. If reading is erratic and more than 27 N·m (20 lb-ft), lubricate or clean compressor pivot points. If reading is smooth and less than 27 N·m (20 lb-ft), torque belt to the following specification:

Used belt	20 N·m (15 lb-ft)
New belt	35 N·m (25 lb-ft)

IMPORTANT: Slowly increase to necessary torque. Do not over-torque then relax to correct tension. Friction will cause belt to be overtensioned. Tolerance is ± 4 N·m (± 3 lb-ft).

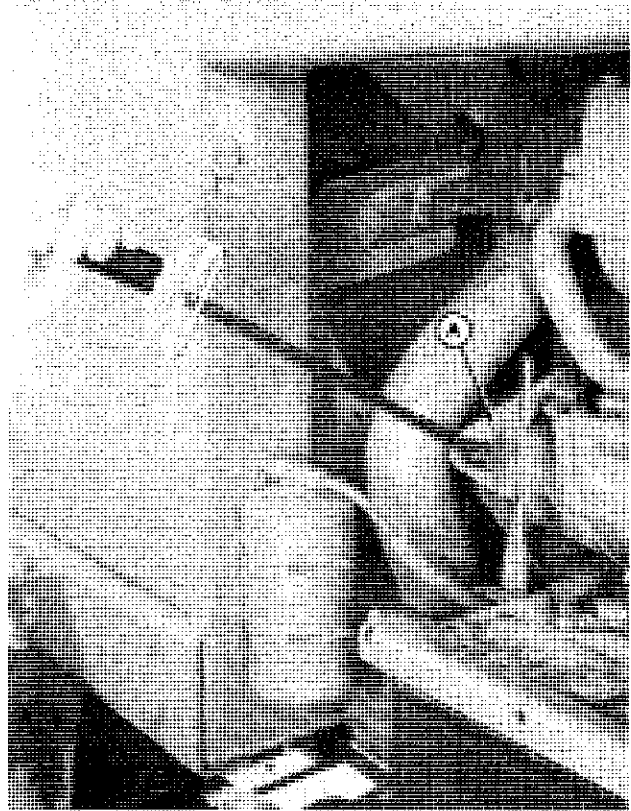

0A9;E28012 E03;;1015 AL 200686

CHECK FUEL FILTERS

1. Drain fuel from filters.
2. Push top of each retainer (A) inward enough to release tab.
3. Remove filters and replace as needed.
4. Bleed fuel system.



0A9;E28013 E03;;1015 AM 200686

BLEED FUEL SYSTEM

1. Loosen bleed plug (A).
2. Loosen manual fuel pump plunger (B) and pump until air bubbles disappear at bleed plug.
3. Retighten bleed plug and fuel pump plunger.

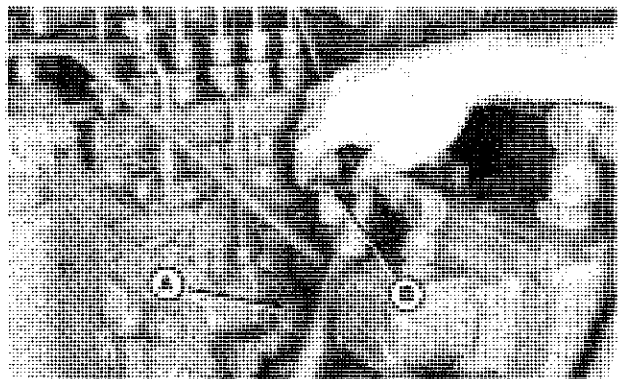

0A9;E28014 E03;;1015 AN 200686

CHECK AND ADJUST INJECTION PUMP TIMING

1. Disconnect crankcase vent tube (A) and remove two plastic plugs (B) from flywheel housing.
2. Install JDG 81-1 Engine Rotation Tool and JDE 81-4 Timing Pin.

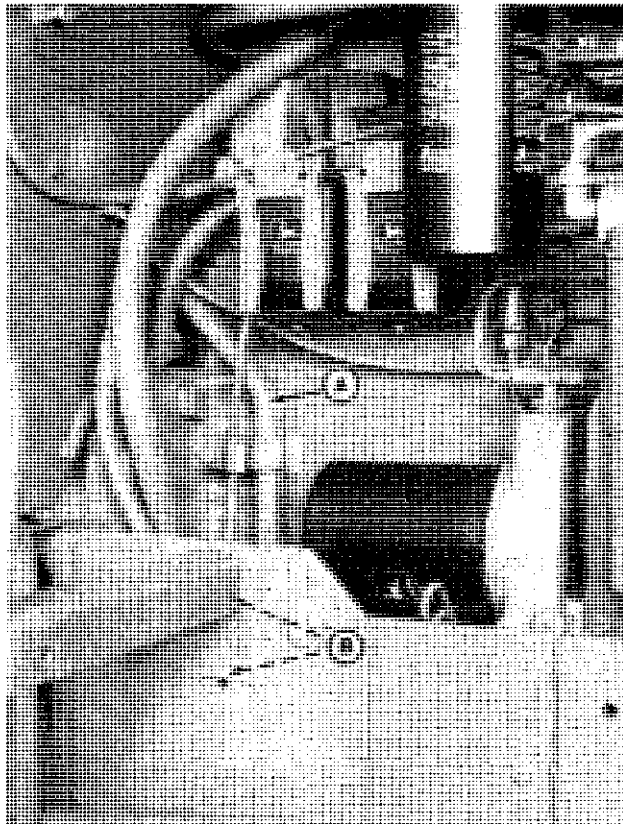

0A9;E28015 E03;;1015 AO 200686

3. Remove timing hole plug and look into hole (A). Rotate flywheel and observe when injection pump drive hub timing mark (B) aligns with pointer mark (C). JDE 81-4 Timing Pin should now enter hole in flywheel.
4. If timing pin will not enter hole in flywheel, injection pump timing must be adjusted.
5. Rotate engine in running direction until timing pin enters flywheel hole at TDC of No. 1 cylinder compression stroke.
6. Remove timing gear cover plate and loosen injection pump gear to hub cap screws.

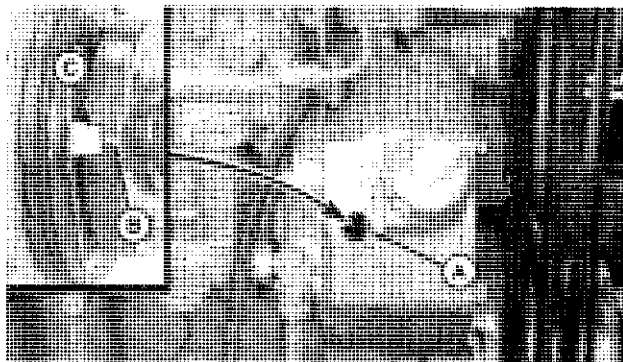

0A9;RG3599 E03;;1015 AP 240986

Tune-Up

7. Rotate pump hub until pump timing mark aligns with pointer mark.

8. Torque pump hub cap screws to 55 N·m (40 lb-ft).

IMPORTANT: Normal gear backlash is enough to throw pump timing off several degrees. Avoid possible inaccurate timing by rotating flywheel an additional two revolutions in running direction until timing pin again engages flywheel at TDC of No. 1 cylinder compression stroke.

9. Recheck timing and repeat adjustment procedure if necessary until timing is correct.

10. Reinstall timing gear cover, all plugs, and crankcase vent tube.

E03;;1015 AQ 200686

CHECK AND ADJUST SLOW AND FAST IDLE SPEEDS.

1. Use tachometer on steering column (A) for checking slow and fast idle speeds.
2. Slow idle speed should be 800 rpm and fast idle speed at no load should be 2300 rpm.
3. Refer to Section 230, Diesel Fuel System, for adjustments on slow and fast idle speeds.

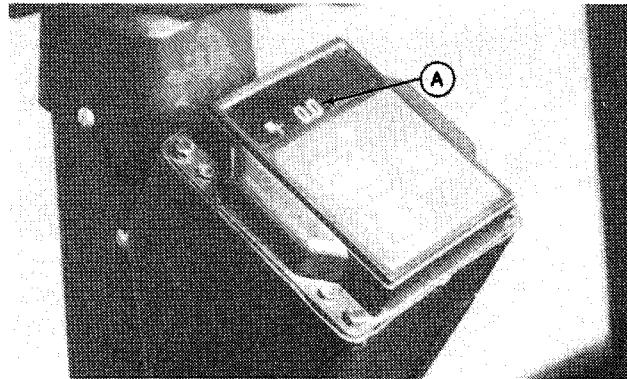

0A9;E28016 E03;;1015 AR 200686

SERVICE BATTERY

1. Clean batteries by wiping them with a damp cloth. Clean and tighten all connections. Remove any corrosion, and wash terminals with a solution of 1 part baking soda and 4 parts water.
2. Check level of electrolyte in each cell (A). If low, fill to bottom of filler necks with CLEAN, SOFT water.

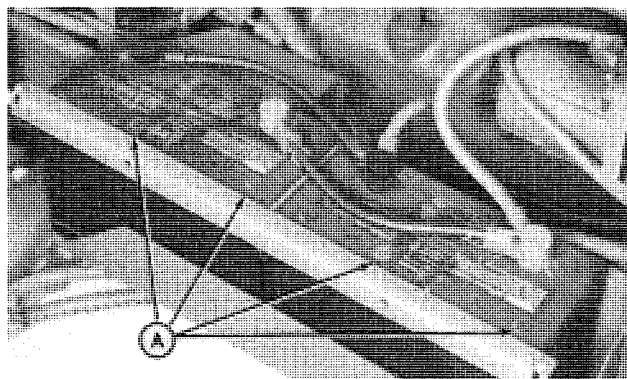

0A9;E28017 E03;;1015 AS 200686



CAUTION: Gas given off by batteries is explosive. Keep sparks and flames away from batteries. Make last connection and first disconnection at a point away from batteries.

3. Fully charge battery by attaching positive battery lead to positive terminal on starter solenoid (A). Attach negative battery charger lead to a good ground on harvester frame (B).

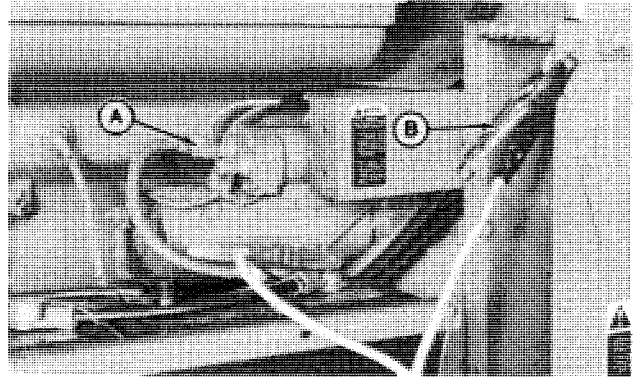

0A9;E28018 E03;;1015 AT 200686

MAKE FINAL ENGINE TEST

1. Repeat dynamometer test as instructed in Sections 220 and 225, System Tests and Diagnosis. Compare performance with previous test, and record for future reference.
2. Engine output should be 145 kW (195 hp) for 5730 and 194 kW (260 hp) for 5830 at full load.

E03;;1015 AU 200686

FABRICATED TOOLS

These tools can be made in the dealers shop for ease in removing the hood.

- A—5 x 76 mm
(3/16 x 3 in.)
- B—70 mm (2-3/4 in.)
- C—152 mm (6 in.)
- D—14 mm (9/16 in.)
- E—51 mm (2 in.) or large
enough for holst
- F—6 x 102 x 254 mm
(1/4 x 4 x 10-in.)
- G—13 x 51 mm (1/2 x 2-in.)
Cap Screw and Nut

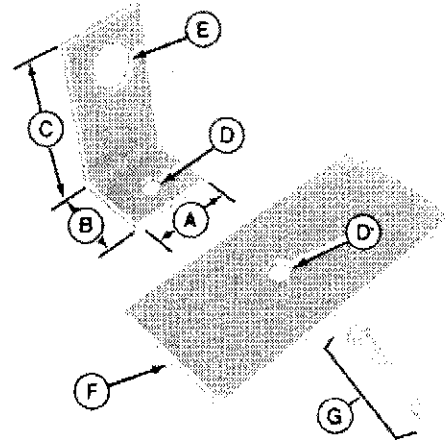

0A9;E20591 E03;;1020 Q 200686

REMOVE ENGINE

1. Remove precleaner (A), muffler (B), radiator screen (C), and engine hood.

NOTE: See Remove Rotary Air Screen, this group, if harvester is equipped with rotary screen.

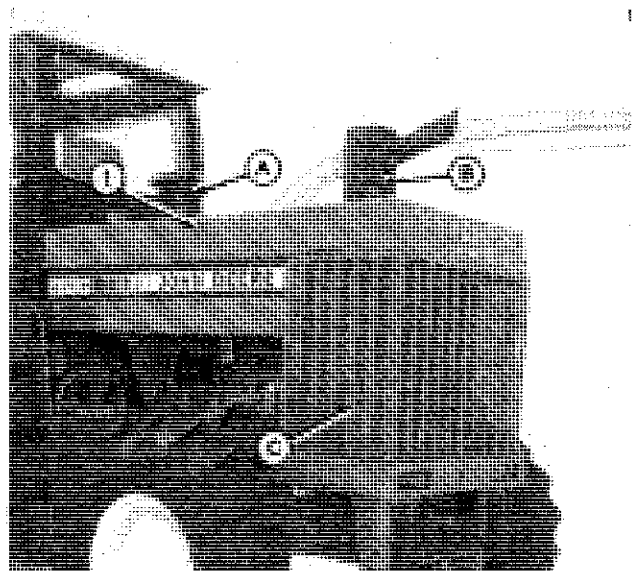

0A9;E28019 E03;;1020 R 200686

Engine Removal

NOTE: See Fabricated Tools for instructions to make a hood removal tool.

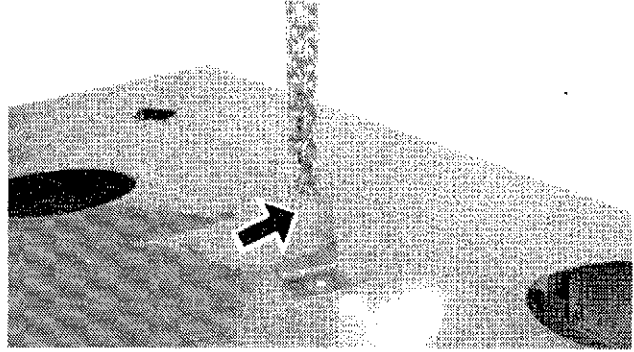

0A9;E20593 E03;1020 S 200686

2. Drain cooling system.
3. Disconnect upper and lower radiator hoses.

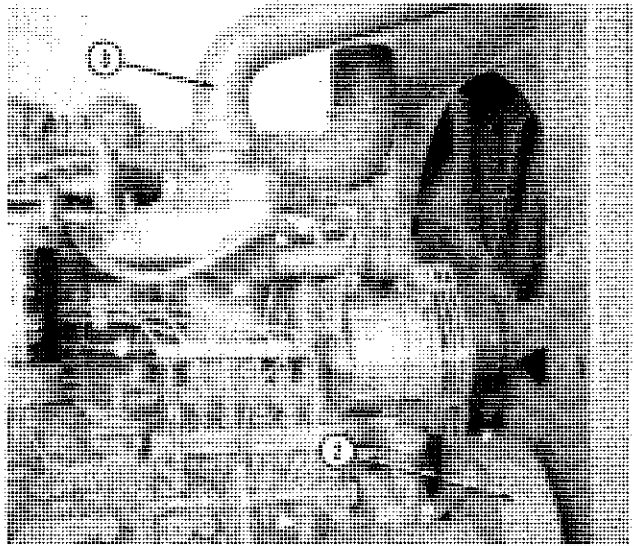

0A9;E20594 E03;1025 C1 270282

Engine Removal

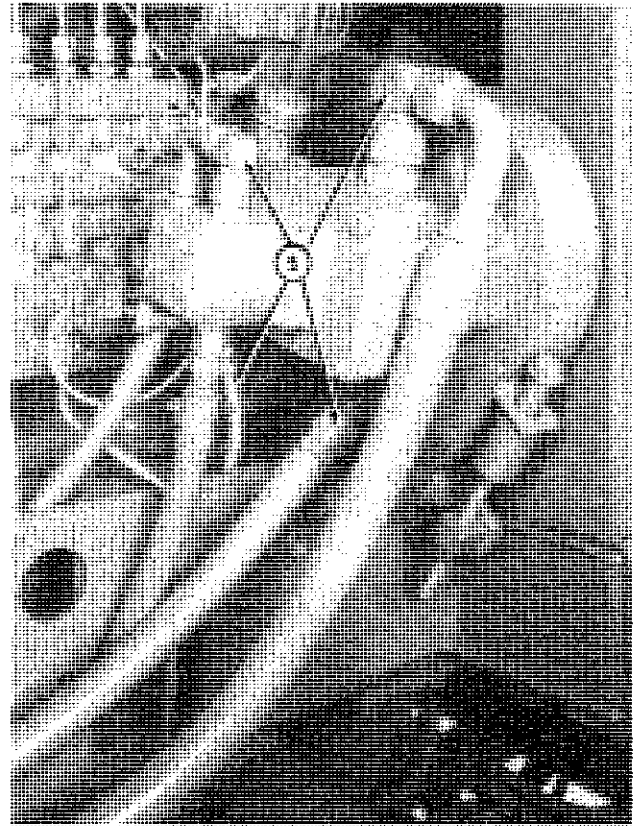
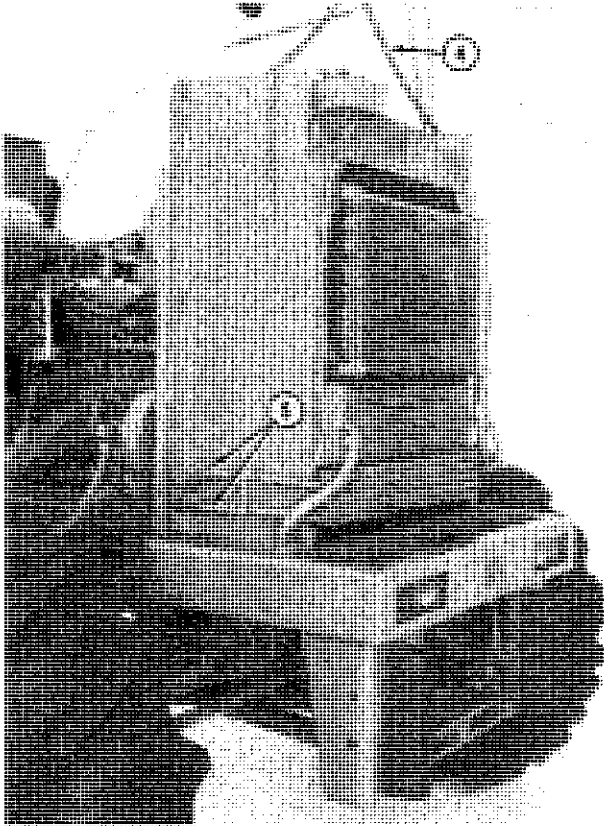

4. Attach a chain with hoist to each side of radiator.

IMPORTANT: Avoid contamination by capping all hoses and openings.

5. Disconnect gear case, hydrostatic cooler hoses, and sending unit.

0A9;E28020 E28021 E03;;1020 T 240986



CAUTION: When disconnecting the refrigerant hoses in step 6, first discharge the compressor or complete system as explained in Section 90. Follow all safety precautions to avoid personal injury.

6. Disconnect condenser core upper hose and push through hole in frame. Disconnect hose at receiver-drier.
7. Remove two cap screws on each side of radiator. Move radiator rearward to clean fan and remove.

IMPORTANT: Protect the radiator from damage after removal.

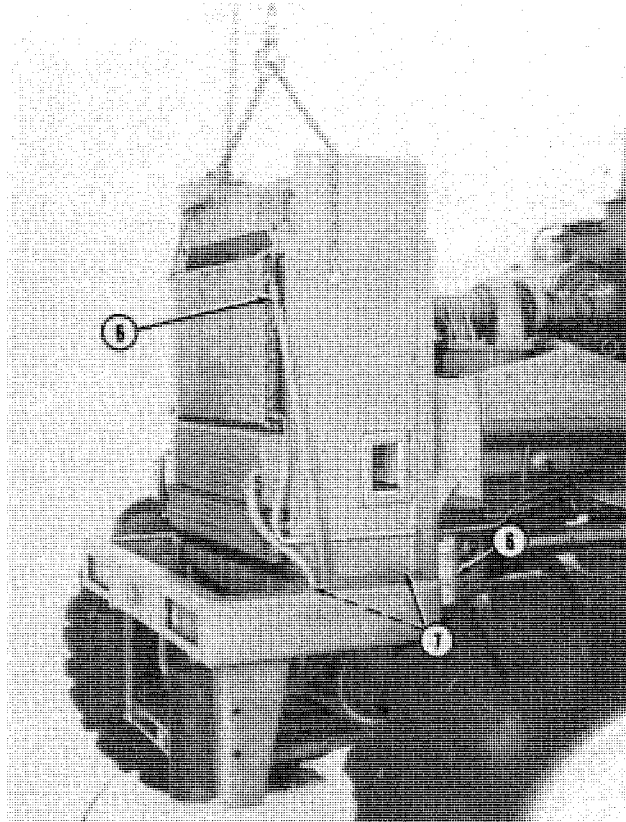

0A9;E28022 E03;;1020 U 240986

8. Remove air tube to turbocharger. Stuff a cloth rag in the intake and exhaust of turbocharger to protect it from foreign materials which could damage it.

9. Disconnect and remove batteries.

10. If harvester is equipped with air-conditioning, remove shields and compressor and secure to the outside of main frame member. Do not disconnect the refrigerant hoses.

11. Cut the plastic wiring harness ties. Disconnect wiring harnesses from connectors.

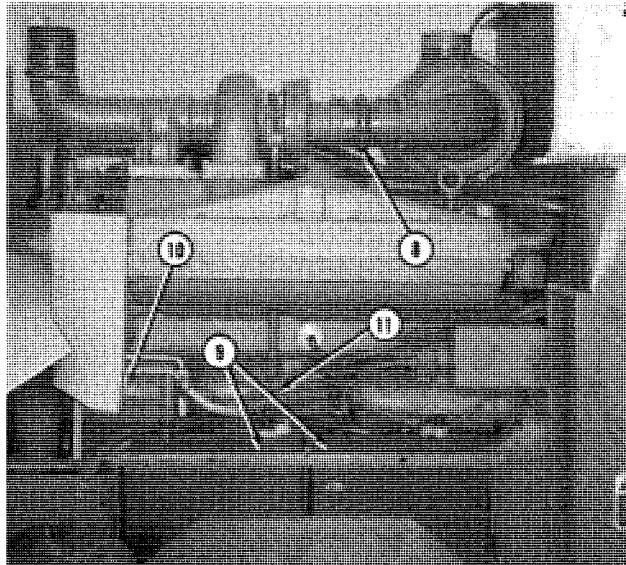

0A9;E28023 E03;;1020 V 200686



Suggest:

If the above button click is invalid.

Please download this document

first, and then click the above link

to download the complete manual.

Thank you so much for reading

Engine Removal

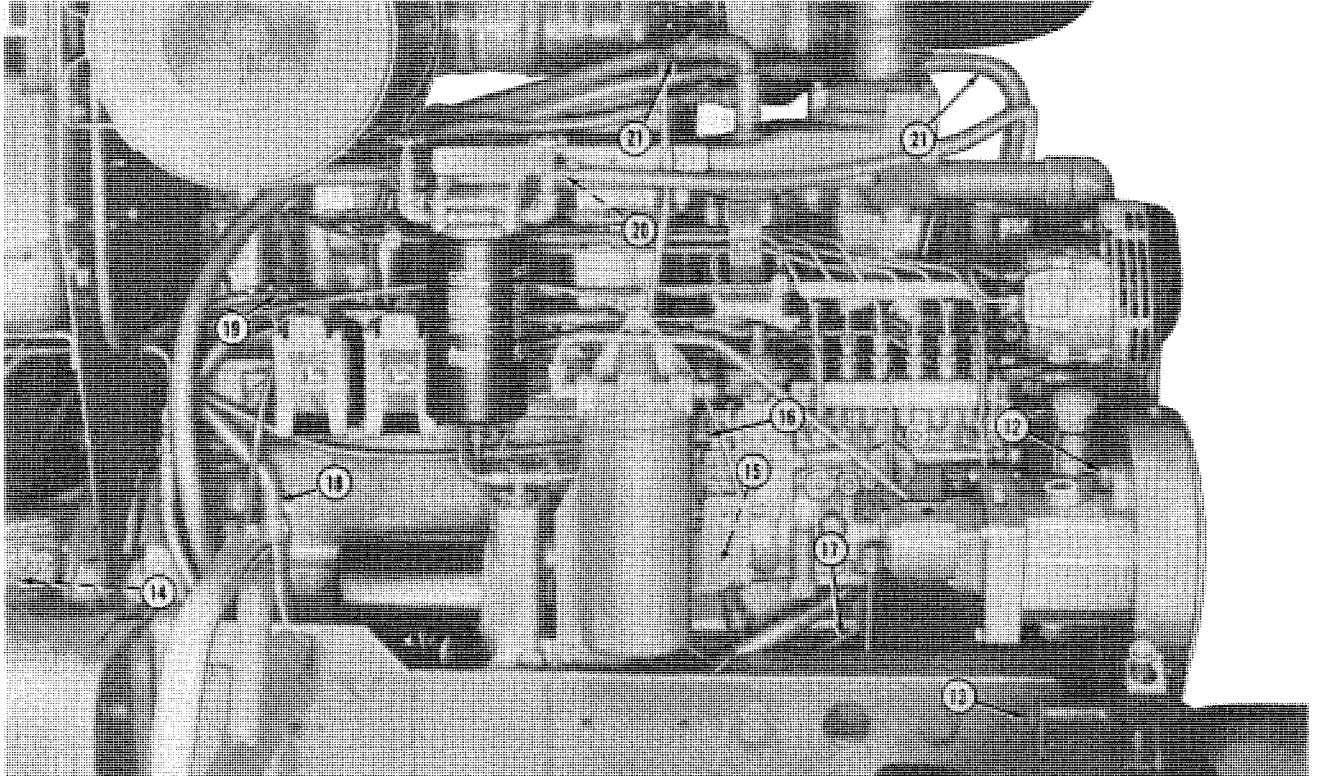

12. Remove cap screw and shield.

13. Loosen lower hydraulic pump mounting cap screws. Move pump inward and remove U-belt. Pull pump outward and down to be out of the way of engine when it is removed.

14. Shut off fuel at fuel tank.

15. Disconnect oil pressure sending unit wire.

16. Disconnect engine shut-off cable and throttle cable at injection pump.

17. Disconnect fuel inlet line at injection pump.

18. Remove vent pipe.

19. Disconnect fuel leak off line after number 6 injector.

20. Cut wiring harness ties. Disconnect water temperature sending unit wire and wire harness.

21. Disconnect heater hoses.

<https://www.ebooklibonline.com>

Hello dear friend!

Thank you very much for reading.

Enter the link into your browser.

The full manual is available for immediate download.

<https://www.ebooklibonline.com>