

255 260 265 270 275 280 285 290 295 300 305 310 315 320 325 330 335 340 345 350 355 360 365 370 375 380 385 390 395 400 405 410 415 420 425 430 435 440 445 450 455 460 465 470 475 480 485 490 495 500 505 510 515 520 525 530 535 540 545 550 555 560 565 570 575 580 585 590 595 600 605 610 615 620 625 630 635 640 645 650 655 660 665 670 675 680 685 690 695 700 705 710 715 720 725 730 735 740 745 750 755 760 765 770 775 780 785 790 795 800 805 810 815 820 825 830 835 840 845 850 855 860 865 870 875 880 885 890 895 900 905 910 915 920 925 930 935 940 945 950 955 960 965 970 975 980 985 990 995

255 260 265 270 275 280 285 290 295 300 305 310 315 320 325 330 335 340 345 350 355 360 365 370 375 380 385 390 395 400 405 410 415 420 425 430 435 440 445 450 455 460 465 470 475 480 485 490 495 500 505 510 515 520 525 530 535 540 545 550 555 560 565 570 575 580 585 590 595 600 605 610 615 620 625 630 635 640 645 650 655 660 665 670 675 680 685 690 695 700 705 710 715 720 725 730 735 740 745 750 755 760 765 770 775 780 785 790 795 800 805 810 815 820 825 830 835 840 845 850 855 860 865 870 875 880 885 890 895 900 905 910 915 920 925 930 935 940 945 950 955 960 965 970 975 980 985 995

Operator's Manual



TECHNICAL MANUAL

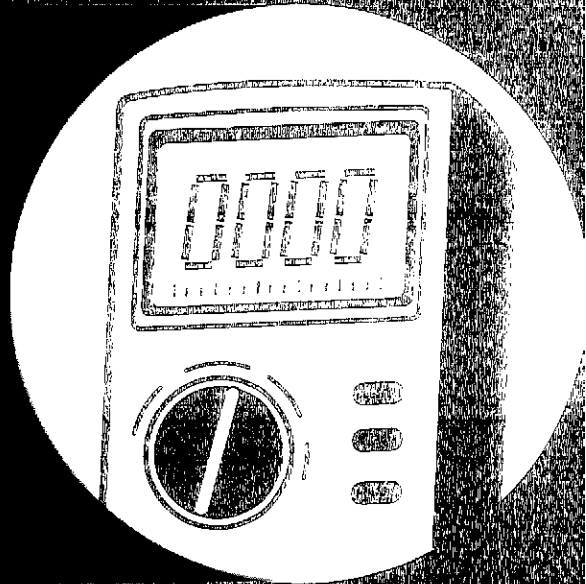



2155, 2355N, 2355, 2555, 2755, 2855N, 2955 AND 3155 TRACTORS TECHNICAL MANUAL TM4436 (MAY-90)

SECTION CONTENTS IN GROUPS – OPERATION AND TESTS

210 – Safety

220 – Engine

- 05 – Radiator and viscous fan drive
- 10 – Tests

230 – Fuel and Air Intake System

- 05 – Fuel tank, auxiliary fuel tank and water trap
- 10 – Cold weather starting aids
- 15 – Speed control linkage
- 20 – Air cleaner

240 – Electrical System

- 05 – General
- 10 – Electrical diagrams (without SGB or ROPS)
- 15 – Circuit diagnosis (without SGB or ROPS)
- 16 – Electrical diagrams (GP tractors without SGB, from Serial No. 618 700L)
- 17 – Circuit diagnosis (GP tractors without SGB, from Serial No. 618 700L)
- 20 – Electrical diagrams (with SGB or ROPS)
- 25 – Circuit diagnosis (with SGB or ROPS)
- 30 – Testing components
- 35 – Starting motor
- 40 – Alternator

250 – Power Train

- 05 – Clutch operating linkages
- 10 – Engine single-stage clutch (without reverser)
- 15 – Engine single-stage clutch (with reverser)
- 20 – Engine dual-stage clutch
- 25 – Hi-Lo shift unit
- 30 – Reverser
- 35 – Creeper transmission
- 40 – Transmission shift linkages
- 45 – Synchronized transmission and transmission oil pump
- 50 – Coliar shift transmission and transmission oil pumps
- 55 – Differential
- 60 – Final drives
- 65 – Independent PTO
- 70 – Continuous-running PTO
- 75 – Front PTO
- 80 – Front wheel drive u.j. drive shaft and disk clutch

COPYRIGHT © 1990 DEERE & Co.
European Office Mannheim
All rights reserved
A John Deere ILLUSTRATION™ Manual
PREVIOUS EDITIONS
COPYRIGHT © 1988

INHALT-LB901AE-010789

SECTION CONTENTS IN GROUPS – OPERATION AND TESTS (CONTD.)

- Steering System and Brakes

Hydrostatic steering
Power steering
Hydraulic brakes
Handbrake

- Hydraulic System

Operation and tests
Valves, filters, oil cooler and oil reservoir
Hydraulic pumps
Rockshaft
Selective control valves (spool type)
Selective control valves (poppet valve type)
ISO breakaway couplers
ISO quick couplers
Remote cylinder

290 – Operator's Station

05 – Air conditioning system
10 – Cab ventilation and heating system

<https://www.ebooklibonline.com>







Hello dear friend!

Thank you very much for reading.

Enter the link into your browser.

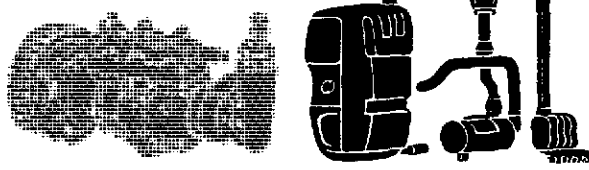
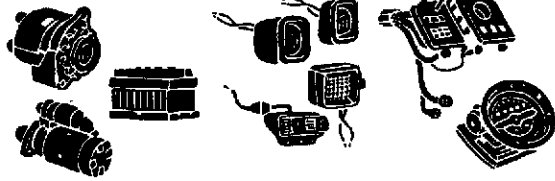
The full manual is available for immediate download.

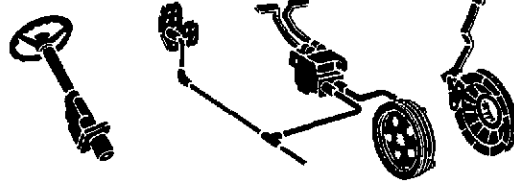
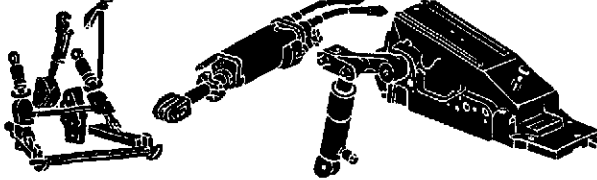
<https://www.ebooklibonline.com>

<p>SAFETY</p>		<p>210</p>
<p>ENGINE</p>		<p>220</p>
<p>FUEL AND AIR INTAKE SYSTEM</p>		<p>230</p>
<p>ELECTRICAL SYSTEM</p>		<p>240</p>
<p>POWER TRAIN</p>		<p>250</p>
<p>STEERING SYSTEM AND BRAKES</p>		<p>260</p>
<p>HYDRAULIC SYSTEM</p>		<p>270</p>
<p>OPERATOR'S STATION</p>		<p>290</p>

SAFETY AND YOU

This is the safety-alert symbol. When you see this symbol on the machine or in this manual, be alert to the potential for personal injury.



T 81389

T81389;053;TMSAFE 19 07OCT85

IMPORTANT

The **IMPORTANT** message identifies potential problems which may cause consequential damage to machine. Following recommended procedure will instruct technician how to avoid problem.

A68;N01;0000 19 U 05NOV82

NOTES

The word **NOTE** is followed by a statement that identifies a qualification or exception to a previous statement. A "NOTE" may also identify nice-to-know information pertinent to, but not directly related to previous statement.

A68; N01;0000 19 V 05NOV82



OBSERVE SAFETY RULES

Avoid loose clothing that can catch in moving parts and put you out of work.

Wear your safety glasses while on the job.

Avoid working on equipment with the engine running. If it is necessary to make checks with the engine running, **ALWAYS USE TWO PEOPLE** – with the operator, at the controls, able to see the person doing the checking. Also, put the transmission in neutral, set the brake, and apply safety locks provided. **KEEP HANDS AWAY FROM MOVING PARTS.**

Keep transmission and brake control units properly adjusted at all times. Before making adjustments, stop engine.

Before removing any housing covers, stop engine. Take all objects from your pockets which could fall into the opened housings. Don't let adjusting wrenches fall into opened housings.

Don't attempt to check belt tension while the engine is running.

Don't adjust the fuel system while the machine is in motion.

Before repairing the electrical system, or performing a major overhaul, make sure the batteries are disconnected.

A69; N01.0000 19 S 05NOV82

PREPARE FOR EMERGENCIES

Be prepared if a fire starts.

Keep a first aid kit and fire extinguisher handy.

Keep emergency numbers for doctors, ambulance service, hospital and fire department near your telephone.

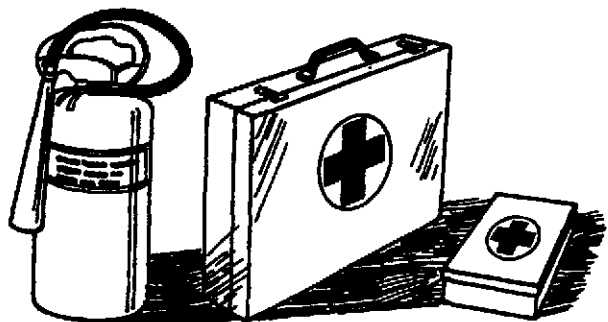

L 114 052

L114052:053;FIR2 19 15MAR89



HANDLE FLUIDS SAFELY – AVOID FIRES

When you work around fuel, do not smoke or work near heaters or other fire hazards.

Store flammable fluids away from fire hazards. Do not incinerate or puncture pressurized containers.

Make sure machine is clean of trash, grease and debris.

Do not store oily rags; they can ignite and burn spontaneously.



TS 227

TS227;053;FLAME 19 05JAN88

PREVENT BATTERY EXPLOSIONS

Keep sparks, lighted matches, and open flame away from the top of battery. Battery gas can explode.

Never check battery charge by placing a metal object across the posts. Use a volt-meter or hydrometer.

Do not charge a frozen battery; it may explode. Warm battery to 16°C (60°F).

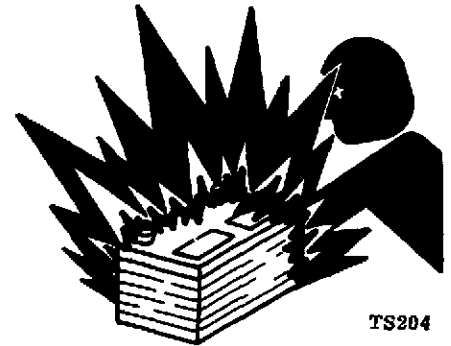

TS204

TS204;053;SPARKS 19 26JUN88

PREVENT ACID BURNS

Sulfuric acid in battery electrolyte is poisonous. It is strong enough to burn skin, eat holes in clothing and cause blindness if splashed into eyes.

Avoid the hazard by:

1. Filling the batteries in a well-ventilated area.
2. Wearing eye protection and rubber gloves.
3. Avoiding breathing fumes when electrolyte is added.
4. Avoiding spilling or dripping electrolyte.
5. Use proper jump start procedure.

If you spill acid on yourself:

1. Flush your skin with water.
 2. Apply baking soda or lime to help neutralize the acid.
 3. Flush your eyes with water for 10 – 15 minutes.
- Get medical attention immediately.

If acid is swallowed:

1. Drink large amounts of water or milk.
2. Then drink milk of magnesia, beaten eggs or vegetable oil.
3. Get medical attention immediately.



TS203

TS203;053;POISON 19 21DEC87



AVOID HIGH-PRESSURE FLUIDS

Escaping fluid (fuel or hydraulic oil) under pressure can penetrate the skin causing serious injury. Relieve pressure before disconnecting hydraulic or other lines. Tighten all connections before applying pressure. Keep hands and body away from pinholes and nozzles which eject fluids under high pressure. Use a piece of cardboard to search for leaks.

If ANY fluid is injected into the skin, it must be surgically removed within a few hours by a doctor familiar with this type of injury, or gangrene may result.

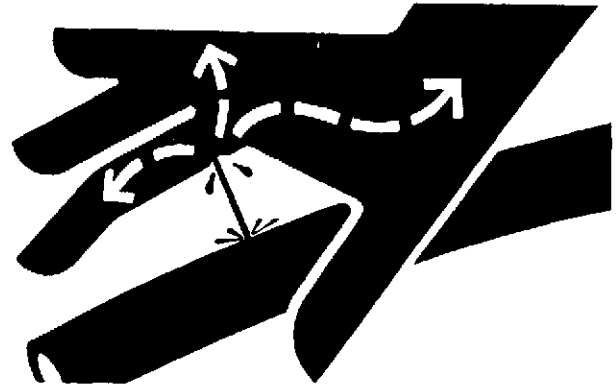

X9811

X9811;053;FLUID 19 18SEP87

AVOID HARMFUL ASBESTOS DUST

Avoid breathing dust that may be generated when handling components containing asbestos fibers. Inhaled asbestos fibers may cause lung cancer.

Components in John Deere products that may contain asbestos fibers are brake pads, brake band and lining assemblies, clutch plates and some gaskets. The asbestos used in these components is usually found in a resin or sealed in some way. Normal handling is not hazardous as long as airborne dust containing asbestos is not generated.

Avoid creating dust. Never use compressed air for cleaning. Avoid brushing or grinding of asbestos-containing materials. When servicing, wear an approved respirator. A special vacuum cleaner is recommended to clean asbestos. If not available, wet the asbestos-containing materials with a mist of oil or water.

Keep bystanders away from the area.

Please note designations on spare parts.

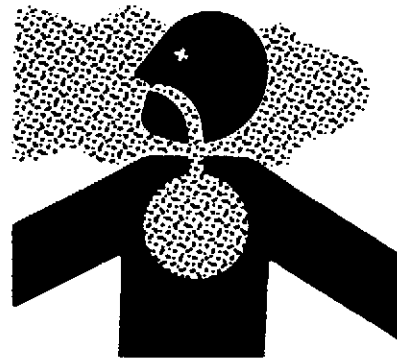

TS 220



L 114 051

TS220.L114051;053;DUST 19 14APR88



WORK IN VENTILATED AREA

Engine exhaust fumes can cause sickness or death. If it is necessary to run an engine in an enclosed area, remove the exhaust fumes from the area with an exhaust pipe extension.

If you do not have an exhaust pipe extension, open the doors and get outside air into the area.

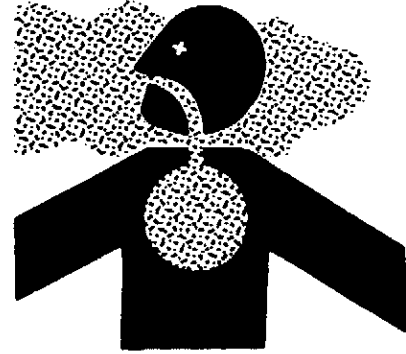

TS 220

TS220;053;AIR 19 05JAN88

WORK IN CLEAN AREA

Before starting a job:

- Clean work area and machine.
- Make sure you have all necessary tools to do your job.
- Have the right parts on hand.
- Read all instructions thoroughly; do not attempt shortcuts.

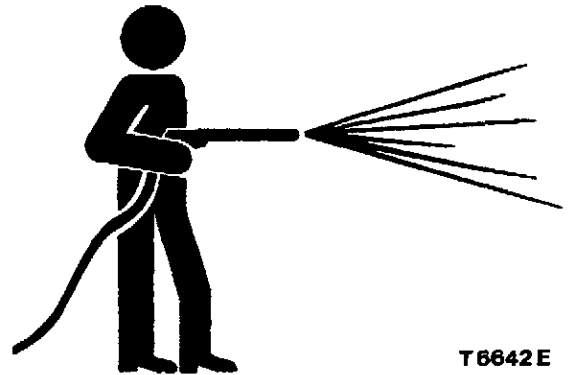

T 6642 E

T6642E;053;CLEAN 19 19JAN88

PARK MACHINE SAFELY

Before working on the machine:

- Lower all equipment to the ground.
- Stop the engine and remove the key.
- Disconnect the battery ground strap.
- Hang a "DO NOT OPERATE" tag in operator station.

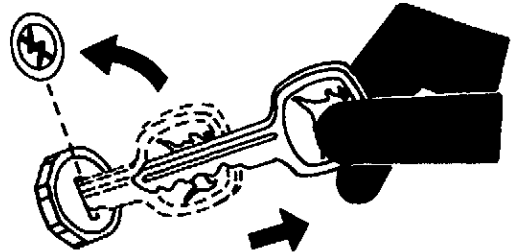

TS 230

TS230;053;PARK 19 05JAN88

PREVENT MACHINE RUNAWAY

Avoid possible injury or death from a machine runaway.

Do not start the engine by shorting across starter terminals. Machine will start in gear if normal circuitry is bypassed.

NEVER start engine while standing on ground. Start engine only from operator's seat, with the transmission in neutral or "Park".

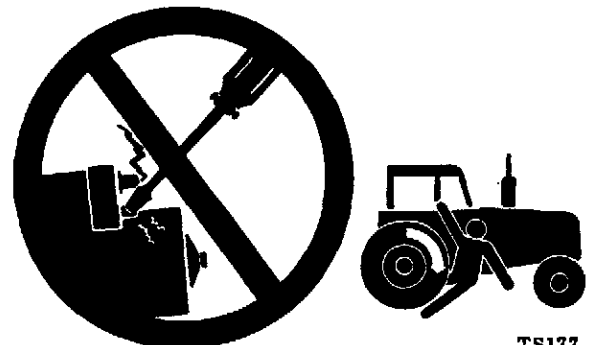

TS177

TS177;053;BYPAS1 19 21MAY85



SERVICE FRONT-WHEEL DRIVE TRACTOR SAFELY

When servicing front-wheel drive tractor with the rear wheels supported off the ground and rotating wheels by engine power, always support front wheels in a similar manner. Loss of electrical power or transmission/hydraulic system pressure will engage the front driving wheels, pulling the rear wheels off the support if front wheels are not raised. Under these conditions, front drive wheels can engage even with switch in disengaged position.

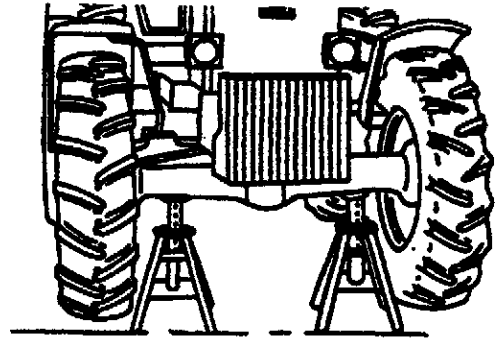

L114050

L114050-ESPDAE-140388

SERVICE MACHINE SAFELY

Tie long hair behind your head. Do not wear a necktie, scarf, loose clothing or necklace when you work near machine tools or moving parts. If these items were to get caught, severe injury could result.

Remove rings and other jewelry to prevent electrical shorts and entanglement in moving parts.

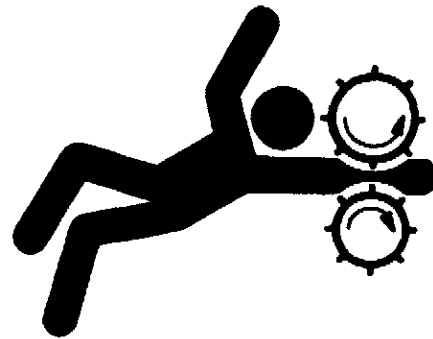

TS228

TS228;053;LOOSE 18 21DEC87

UNDERSTAND CORRECT SERVICE

Illuminate your work area adequately but safely. Use a portable safety light for working inside or under the machine. Make sure the bulb is enclosed by a wire cage. The hot filament of an accidentally broken bulb can ignite spilled fuel or oil.

Catch draining fuel, oil, or other fluids into suitable containers. Do not use food or beverage containers that may mislead someone into drinking from them. Wipe up spills at once.

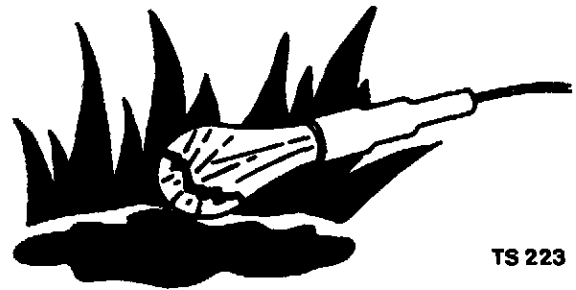

TS 223

TS223;053;LIGHT 19 23FEB88

USE TOOLS PROPERLY

Use tools appropriate to the work. Makeshift tools, parts, and procedures will not make good repairs.

Use pneumatic and electric tools only to loosen threaded parts and fasteners. Never use such tools to tighten fasteners, especially on light alloy parts.

Use only replacement parts meeting John Deere specifications.

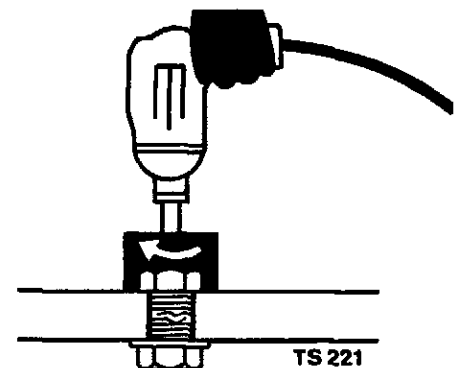

TS 221

TS221;053;REPAIR 19 21DEC87



SUPPORT MACHINE PROPERLY

Always lower the attachment or implement to the ground before you work on the machine. If you must work on a lifted machine or attachment, securely support the machine or attachment.

Do not support the machine on cinder blocks, hollow tiles or props that may crumble under continuous load. Do not work under a machine that is supported solely by a jack. Follow recommended procedures in this manual.

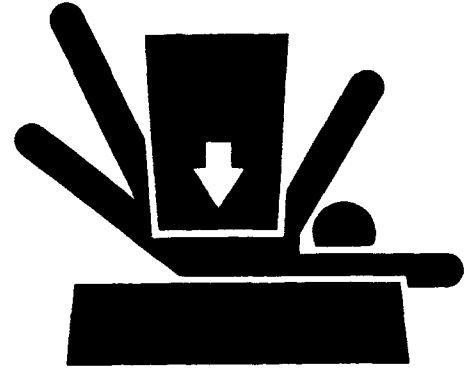

TS 229

TS229;053;LOWER 19 21DEC87

USE PROPER LIFTING EQUIPMENT

Lifting heavy components incorrectly can cause severe injury or machine damage.

Follow recommended procedure for removal and installation of components in the manual.

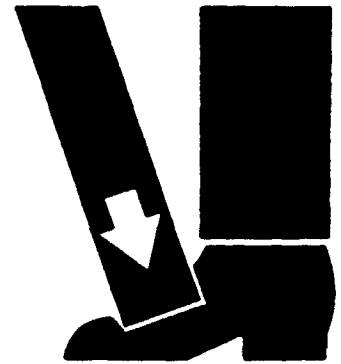

TS 226

TS226;053;LIFT 19 05JAN88

SERVICE TIRES SAFELY

Explosive separation of a tire and rim parts can cause serious injury or death.

Only attempt to mount a tire if you have the proper equipment and experience to perform the job.

Always maintain the correct tire pressure. Do not inflate tires above the recommended pressure.

When inflating tires, use a clip-on chuck and extension hose long enough to allow you to stand to one side and NOT in front of or over the tire assembly. Use a safety cage if available.

Check wheels for low pressure, cuts, bubbles, damaged rims or missing lug bolts and nuts.

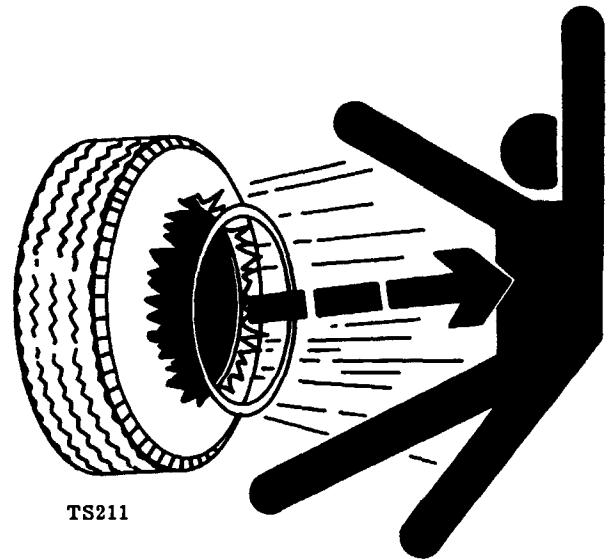

TS211

TS211;053;RIM 19 21DEC87



KEEP CAB/ROPS INSTALLED PROPERLY

Make certain all parts are reinstalled correctly if the cab or roll-over protective structure (ROPS) is loosened or removed for any reason. Tighten mounting bolts to specified torque.

Protection offered by cab or ROPS is impaired if subjected to structural damage, is involved in an overturn incident or is altered in any way by welding, bending, drilling or cutting. A damaged cab or ROPS should be replaced, not reused.

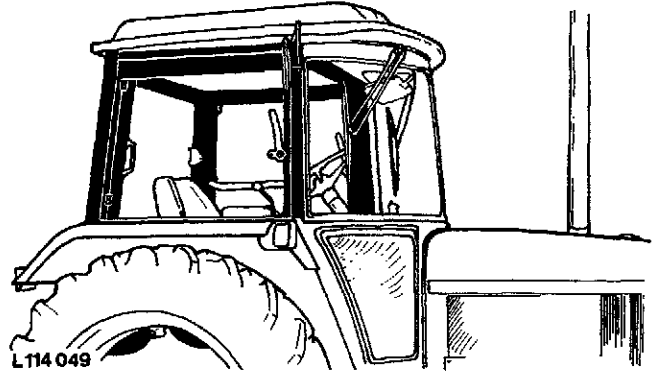

L114049;053;ROPS 19 15MAR89

REPLACE SAFETY SIGNS

Replace missing or damaged safety signs. See the machine operator's manual for correct safety sign placement.

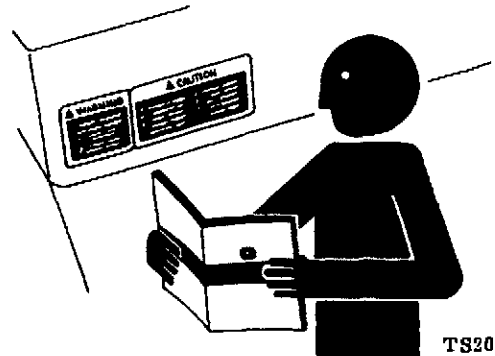

TS201;053;SIGNS1 19 22DEC87

OBSERVE ENVIRONMENTAL PROTECTION REGULATIONS

Be mindful of the environment and ecology.

Before draining any fluids, find out the correct way of disposing of them.

Observe the relevant environmental protection regulations when disposing of oil, fuel, coolant, brake fluid, filters and batteries.

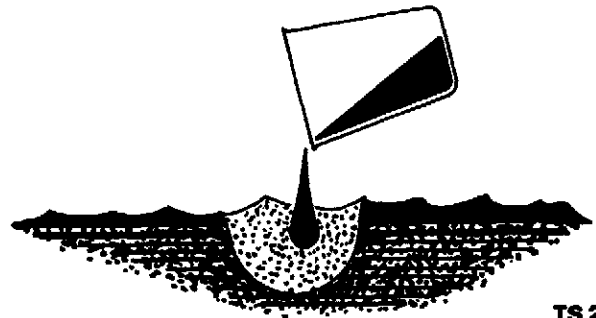

TS222-ESPDAE-140388

LIVE WITH SAFETY

Before returning machine to customer, make sure machine is functioning properly, especially the safety systems. Install all guards and shields.



TS231

TS231;053;LIVE 19 05JAN88

Section 220 ENGINE

NOTE: For engine information, refer to engine component technical manual CTM-4, 3179, 4239 and 6359 engines.

05 – RADIATOR AND VISCOUS FAN DRIVE

Specifications	05-1
Description of radiator	05-1
Function of radiator cap:	
– Tractors with expansion tank	05-2
– Tractors without expansion tank	05-2
Diagnosing malfunctions	05-3
Testing radiator cap on tractors without expansion tank	05-4
Checking cooling system for leaks	05-5
Function of viscous fan drive	05-6

	2155	2355 N	2355	2555	2755	2855 N	2955	3155
Specifications	x	x	x	x	x	x	x	x
Description of radiator	x	x	x	x	x	x	x	x
Function of radiator cap:								
– Tractors with expansion tank	x	x	x	x	x	x	x	x
– Tractors without expansion tank	x	x	x	x	x	x	x	x
Diagnosing malfunctions	x	x	x	x	x	x	x	x
Testing radiator cap on tractors without expansion tank	x	x	x	x	x	x	x	x
Checking cooling system for leaks	x	x	x	x	x	x	x	x
Function of viscous fan drive	x	x	x	x	x	x	x	x

10 – TESTS

Preliminary engine testing	10-1
Dynamometer test	10-1

ENGINE-LB922001AE-010789

Engine

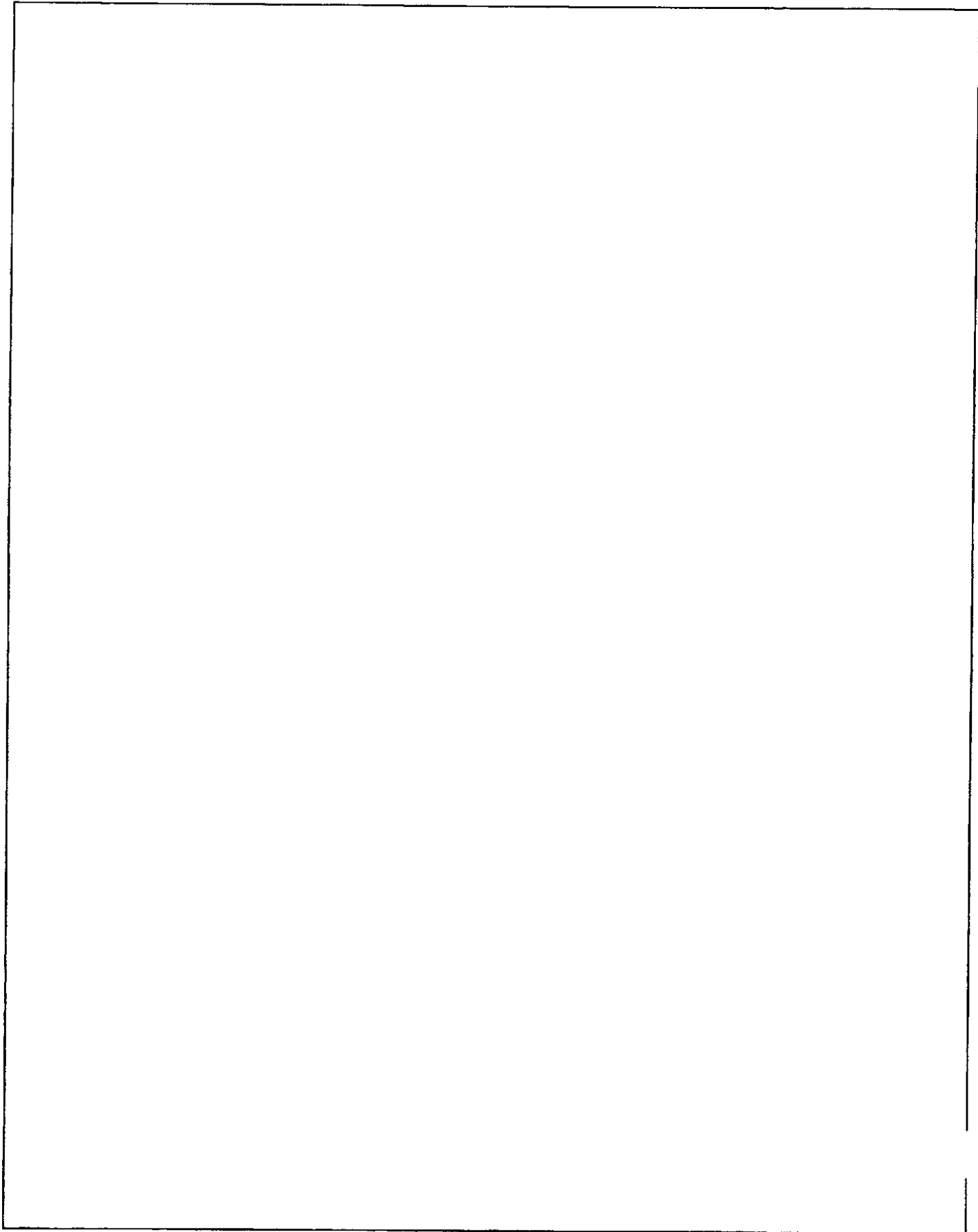

RADIATOR AND VISCOUS FAN DRIVE

SPECIFICATIONS

Tractors Without Expansion Tank

Radiator cap pressure relief valve opens at a pressure of:

- 3-cylinder tractors 40 to 50 kPa (0.4 to 0.5 bar; 6 to 7 psi)
- 4 and 6-cylinder engines 60 to 70 kPa (0.6 to 0.7 bar; 9 to 10 psi)

Tractors With Expansion Tank

Radiator cap pressure relief valve opens at a pressure of:

- 1st stage, normal operation 60 kPa (0.6 bar; 9 psi)
- 2nd stage, should a malfunction occur 120 kPa (1.2 bar; 17 psi)

On All Tractors

- Cooling system test pressure 50 to 70 kPa (0.5 to 0.7 bar; 7 to 10 psi)

KUEHLER-LB522005AE-011087

DESCRIPTION OF RADIATOR

The engine radiator is of the conventional design with cooling tubes through which the coolant passes and soldered exterior fins.

The coolant in the cooling tubes is cooled by air (B) forced through the radiator core by the fan blades. Cooling surface of tubes is greatly increased by means of fins (C).

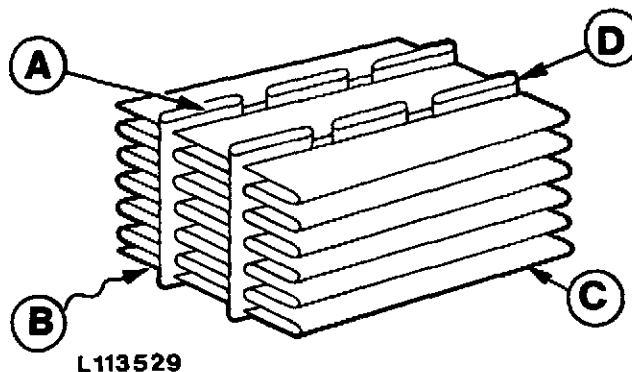

A-Coolant passage
B-Air

C-Fin
D-Tube

L113529-LA722005AE-020186

**FUNCTION OF RADIATOR CAP
(Tractors With Expansion Tank)**

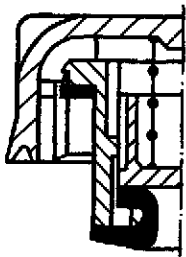
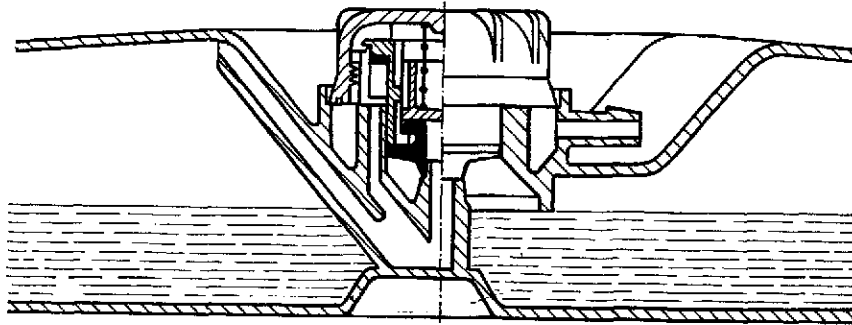

(A)

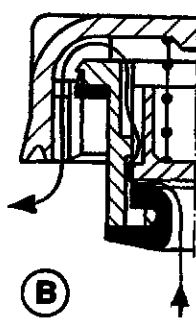

(B)

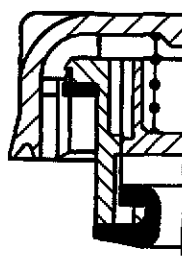

(C)

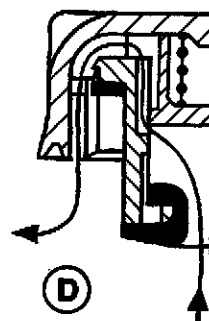

(D)

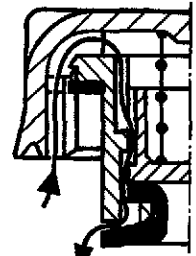

(E)

L 118 404A

A—Pressure below 60 kPa (0.6 bar; 9 psi); pressure relief valve closed
B—Pressure between 60 kPa (0.6 bar; 9 psi) and 80 kPa (0.8 bar; 12 psi); pressure relief valve open

C—Pressure between 80 kPa (0.8 bar; 12 psi) and 120 kPa (1.2 bar; 17 psi); pressure relief valve closed

D—Pressure above 120 kPa (1.2 bar; 17 psi); pressure relief valve open
E—Pressure below 2 kPa (0.2 bar; 0.3 psi); vacuum valve open

Under normal operating conditions, there should be a build-up of pressure in the cooling system (see "A").

To prevent pressure becoming too high, pressure relief valve opens at a specified pressure (see "B").

This pressurized cooling system permits the engine to be operated at high temperatures without coolant boiling or loss of coolant due to evaporation. Higher operating temperatures are desirable for efficient combustion and for evaporating contaminants from the crankcase.

Should the engine become particularly warm, for example if the engine is shut off after operating under heavy load, the pressure relief valve closes and allows a higher pressure build-up and no loss of coolant (see "C").

Should pressure build-up continue (malfunction in system), pressure relief valve will open at a specified pressure in order to prevent damage due to excess pressure (see "D").

To prevent build-up of a vacuum which could occur in the system when the coolant cools, the vacuum valve opens (see "E").

FUNCTION OF RADIATOR CAP (Tractors Without Expansion Tank)

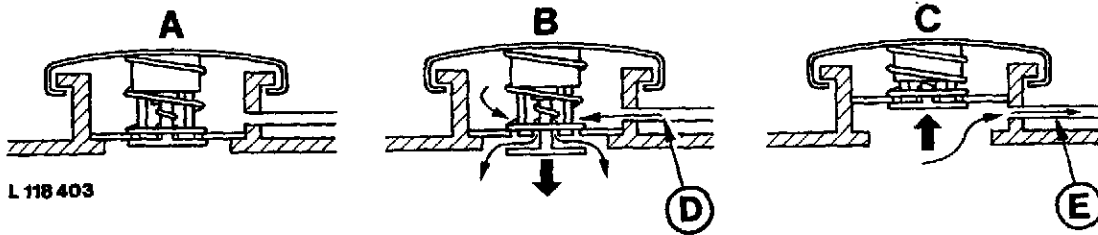

L 118 403

A-Valve closed
B-Vacuum valve open

C-Pressure relief valve open

D-Air
E-Overflow tube

The radiator filler neck has a bayonet-fitting cap which has a pressure relief valve and a vacuum valve. The pressure relief valve (C) in the cap permits the escape of coolant or steam when the pressure reaches a certain level. Vacuum valve (B) in the cap opens at a certain underpressure, thus preventing the build-up of a vacuum in the cooling system.

The pressure cooling system permits the engine to be operated at high temperatures without boiling the coolant or losing it by evaporation. Higher operating temperatures are desirable for efficient combustion and for evaporating contaminants from the crankcase.

L118403-LB522005AE-011087

DIAGNOSING MALFUNCTIONS

ENGINE OVERHEATS

- Slack fan belt
- Dirty radiator or grille screens
- Low coolant level
- Low engine oil level
- Improper operation
- Defective cylinder head gasket
- Fuel injection pump incorrectly timed
- Defective thermostat(s)
- Defective radiator cap
- Defective water pump
- Corrode coolant passages

LOW COOLANT LEVEL

- Improper maintenance
- Improper operation
- Damaged radiator
- Water pump seal leakage
- Leakage
- Defective radiator cap

KUEHLER-LA722005AE-000186

**TESTING RADIATOR CAP
(Tractors Without Expansion Tank)**

Remove radiator cap and test using a commercial radiator and pressure cap tester.

Pressure relief valve in radiator cap should open at the following pressures:

- 3-cylinder engines 40 to 50 kPa
(0.4 to 0.5 bar; 6 to 7 psi)
- 4 and 6-cylinder engines 60 to 70 kPa
(0.6 to 0.7 bar; 9 to 10 psi)

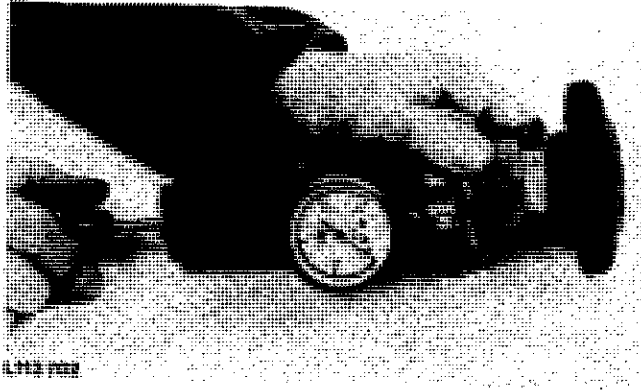

Check radiator cap rubber sealing ring for cracks and brittleness. The bevelled sealing ring must be soft and seated securely.

Check spring.

L113702-LB522005AE-001087

CHECKING COOLING SYSTEM FOR LEAKS

Check radiator, hoses, water pump and engine for leaks, and repair when necessary.

Check exterior of radiator for damage or bent fins.

NOTE: Radiator repairs should be carried out only by experienced mechanics or in specialist repair workshops.

Carefully clean radiator exterior and straighten any bent fins.

Connect commercial radiator tester to filler neck (tractors without expansion tank) or engine block drain tap (tractors with expansion tank).

Apply a pressure of 50 to 70 kPa (0.5 to 0.7 bar; 7 to 10 psi) to the cooling system.

If radiator leaks and source of leak cannot be determined visually, then proceed as follows:

Remove radiator (see relevant T.M. "Repair").

Install radiator cap and plug top hose connection.

Attach compressed air hose to bottom radiator inlet.

Immerse radiator in tank filled with clear water.

By means of attached air hose, carefully place radiator under a test pressure of 50 to 70 kPa (0.5 to 0.7 bar; 7 to 10 psi).

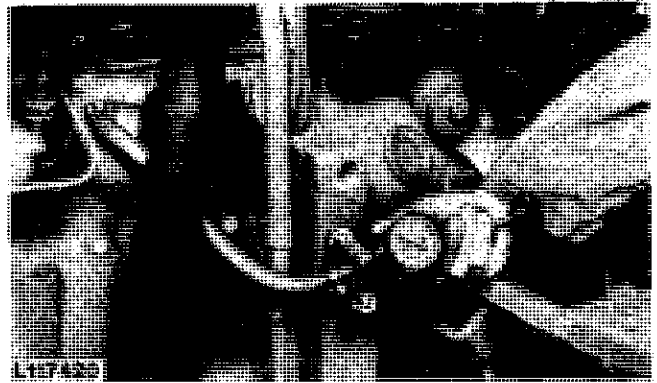
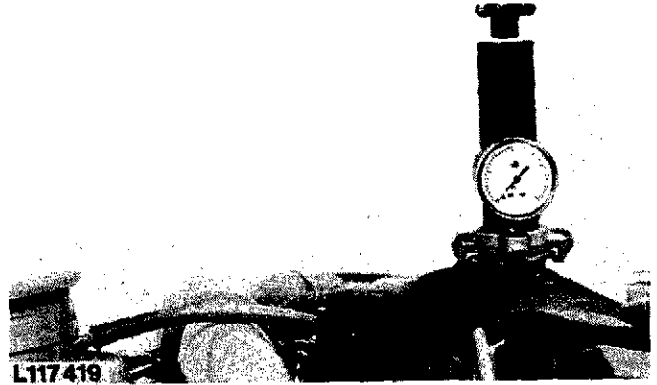

FUNCTION OF VISCOUS FAN DRIVE

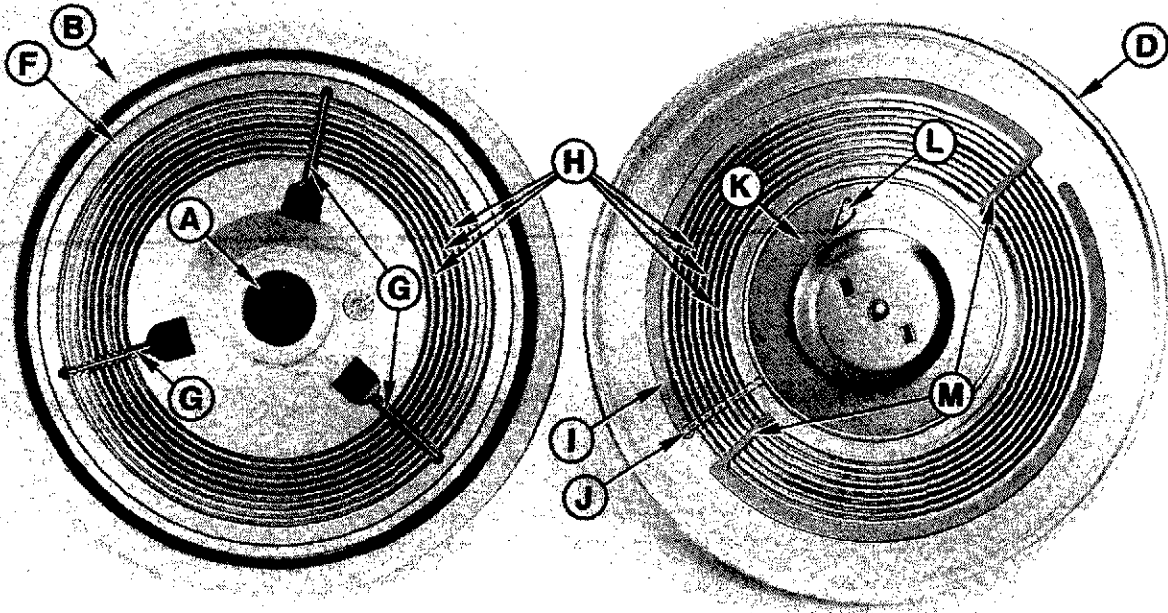
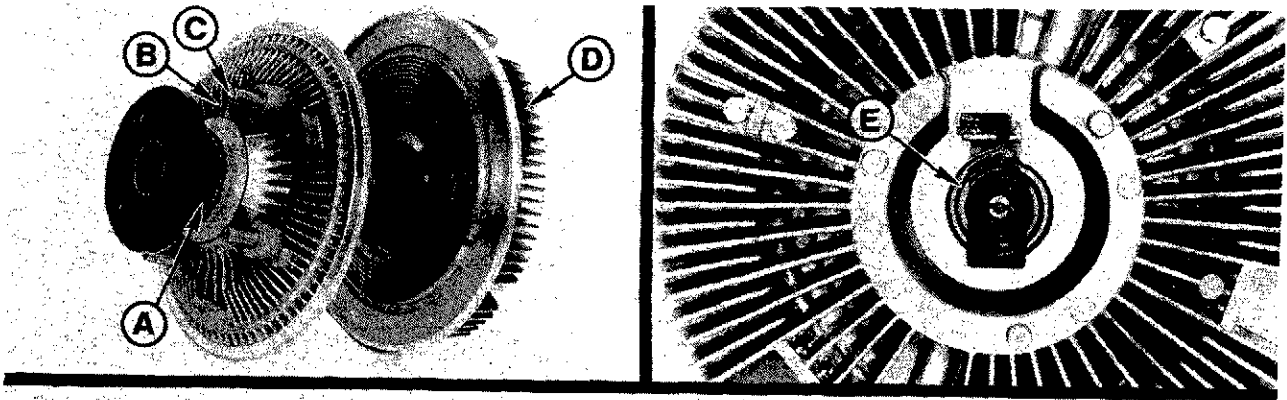

L119 072

A-Drive shaft
 B-Fan carrier
 C-Studs for attaching fan (4 used)
 D-Driven clutch half

E-Bimetallic coiled spring
 F-Driving clutch half
 G-Grooves
 H-Channels (operating chamber)

I-Groove
 J-Return channel
 K-Reservoir
 L-Reservoir cap
 M-Grooves

L119072-LB522005AE-001087



Suggest:

If the above button click is invalid.

Please download this document

first, and then click the above link

to download the complete manual.

Thank you so much for reading

Radiator and Viscous Fan Drive

The viscous fan drive consists of driving clutch half (F) with drive shaft (A), driven clutch half (D) with reservoir (K) and fan carrier (B). The fan carrier is seated with bearings on drive shaft. The channels (H) of both clutch halves form the operating chamber. The system is filled with a silicone fluid.

Torque is transmitted by means of the inner friction between the fluid and the surface of the operating chamber. The operating chamber surface is enlarged by means of grooves.

The amount of silicone fluid in viscous fan drive exceeds capacity of the reservoir so that there is always some fluid in the operating chamber. Consequently, driven clutch half (D) turns even when the radiator is cold, but at a slower speed than the driving clutch half.

As the radiator gets warm, bimetallic spring (E) expands and opens reservoir cap (L). Centrifugal force causes fluid to flow from the reservoir into the operating chamber. The high friction of the fluid in the operating chamber causes the speed of the driven clutch half to increase until both halves are travelling at the same speed.

Centrifugal force causes oil to be forced outwards through groove (I) and, due to rotational speed, to be carried via return channel (J) to the reservoir. A cycle takes place, fluid being constantly forced back into the reservoir and at the same time flowing into the operating chamber.

Because of the high fan speed, radiator temperature sinks. The bimetallic spring coil contracts, closing the reservoir cap and preventing further silicone fluid from flowing to the operating chamber. Fluid continues to flow into reservoir through groove (I). The amount of fluid in the operating chamber decreases, reducing friction and fan speed slows.

Grooves (G and M) enable fluid to flow quicker into the operating chamber, enabling the viscous fan drive to react more quickly to changes in the radiator temperature.

KUEHLER-LBS22005AE-001087

<https://www.ebooklibonline.com>

Hello dear friend!

Thank you very much for reading.

Enter the link into your browser.

The full manual is available for immediate download.

<https://www.ebooklibonline.com>