

**1350, 1360, 1460  
and 1470  
Mower-Conditioners**

**John Deere Arc-lès-Gray  
TM3268 (08AUG03)**

Printed in Germany  
**ANGLAIS**

# Introduction

## FOREWORD

This manual is written for an experienced technician. Essential tools required in performing certain service work are identified in this manual and are recommended for use.

Live with safety: Read the safety messages in the introduction of this manual and the cautions presented throughout the text of the manual.



This is the safety-alert symbol. When you see this symbol on the machine or in this manual, be alert to the potential for personal injury.

Technical manuals are divided in two parts: repair and operation and tests. Repair sections tell how to repair the components. Operation and tests sections help you identify the majority of routine failures quickly.

Information is organized in groups for the various components requiring service instruction. At the beginning of each group are summary listings of all applicable essential tools, service equipment and tools, other materials needed to do the job, service parts kits, specifications, wear tolerances, and torque values.

Technical Manuals are concise guides for specific machines. They are on-the-job guides containing only the vital information needed for diagnosis, analysis, testing, and repair.

Fundamental service information is available from other sources covering basic theory of operation, fundamentals of troubleshooting, general maintenance, and basic type of failures and their causes.

# Contents

## **SECTION 10—General Information**

- Group 05—Safety
- Group 10—General Specifications

## **SECTION 50—Power Train**

- Group 05—Powerline Specifications
- Group 10—Front and Rear Powerlines
- Group 20—Rear Powerline (North America)
- Group 30—Slip Clutch
- Group 40—Main Gear Case
- Group 50—Swivel Gear Case

## **SECTION 70—Hydraulic System**

- Group 05—Lift Cylinder

## **SECTION 100—Cutting Components**

- Group 05—Disks
- Group 10—Cutterbar
- Group 20—Knives

## **SECTION 110—Rotor**

- Group 05—Impeller (1350, 1360)
- Group 10—Roll Drive Gear Case (1460, 1470)
- Group 20—Roll Drive Shafts (1460, 1470)
- Group 30—Rolls (1460, 1470)

## **SECTION 120—Rotor Housing**

- Group 05—Torsion Bar (1460, 1470)

## **Index**

*All information, illustrations and specifications in this manual are based on the latest information available at the time of publication. The right is reserved to make changes at any time without notice.*

TM3268-19-08AUG03

COPYRIGHT© 1993  
DEERE & COMPANY  
European Office Mannheim  
All rights reserved  
A John Deere ILLUSTRATION® Manual  
Previous Editions  
Copyright 1988 Deere & Company

**<https://www.ebooklibonline.com>**

Hello dear friend!

Thank you very much for reading.

Enter the link into your browser.

The full manual is available for immediate download.

**<https://www.ebooklibonline.com>**

# Section 10 General Information

## Contents

Page

**Group 05—Safety** . . . . . 10-05-1

**Group 10—General Specifications**

Machine Specifications . . . . . 10-10-1

Locking Collars for Shaft Bearings . . . . . 10-10-7

Lubrication . . . . . 10-10-7

## PREPARE FOR EMERGENCIES

Be prepared if a fire starts.

Keep a first aid kit and fire extinguisher handy.

Keep emergency numbers for doctors, ambulance service, hospital, and fire department near your telephone.

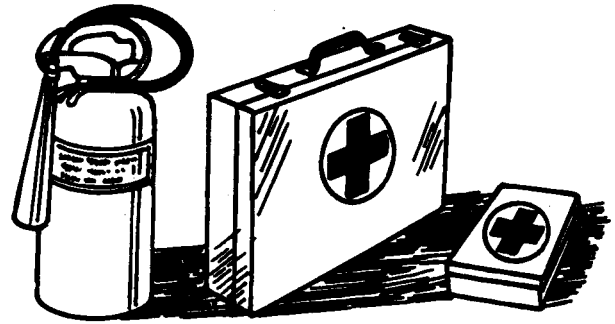

DX,FIRE2 -19-03MAR93

TS291 -JUN-23AUG88

## AVOID HIGH-PRESSURE FLUIDS

Escaping fluid under pressure can penetrate the skin causing serious injury.

Avoid the hazard by relieving pressure before disconnecting hydraulic or other lines. Tighten all connections before applying pressure.

Search for leaks with a piece of cardboard. Protect hands and body from high pressure fluids.

If an accident occurs, see a doctor immediately. Any fluid injected into the skin must be surgically removed within a few hours or gangrene may result. Doctors unfamiliar with this type of injury should reference a knowledgeable medical source. Such information is available from Deere & Company Medical Department in Moline, Illinois, U.S.A.

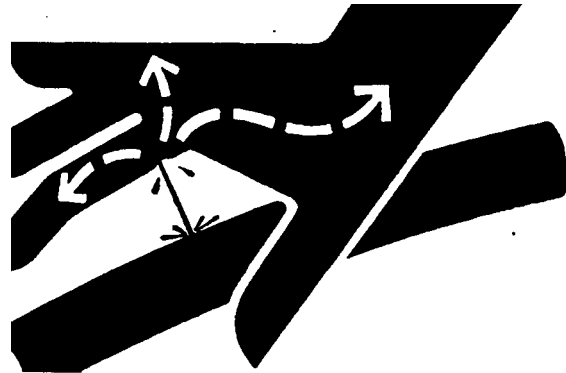

DX,FLUID -19-03MAR93

X9811 -JUN-23AUG88

## PARK MACHINE SAFELY

Before working on the machine:

- Lower all equipment to the ground.
- Stop the engine and remove the key.
- Disconnect the battery ground strap.
- Hang a "DO NOT OPERATE" tag in operator station.

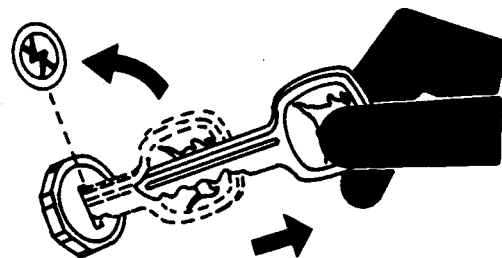

DX,PARK -19-04JUN90

TS230 -JUN-24MAY89

## SUPPORT MACHINE PROPERLY

Always lower the attachment or implement to the ground before you work on the machine. If you must work on a lifted machine or attachment, securely support the machine or attachment.

Do not support the machine on cinder blocks, hollow tiles, or props that may crumble under continuous load. Do not work under a machine that is supported solely by a jack. Follow recommended procedures in this manual.

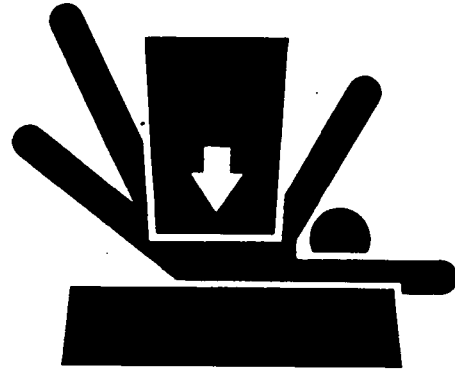

DX,LOWER -19-04JUN90

TS229 -JUN-23AUG88

## WEAR PROTECTIVE CLOTHING

Wear close fitting clothing and safety equipment appropriate to the job.

Prolonged exposure to loud noise can cause impairment or loss of hearing.

Wear a suitable hearing protective device such as earmuffs or earplugs to protect against objectionable or uncomfortable loud noises.

Operating equipment safely requires the full attention of the operator. Do not wear radio or music headphones while operating machine.

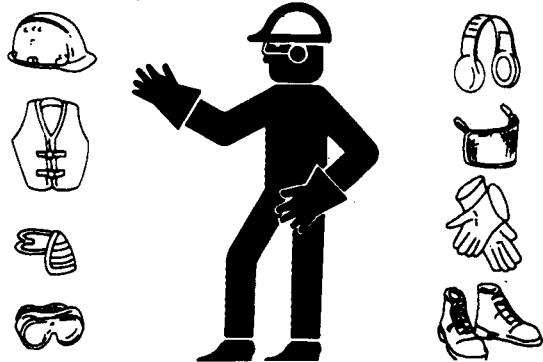

DX,WEAR -19-10SEP90

TS206 -JUN-23AUG88

## WORK IN CLEAN AREA

Before starting a job:

- Clean work area and machine.
- Make sure you have all necessary tools to do your job.
- Have the right parts on hand.
- Read all instructions thoroughly; do not attempt shortcuts.

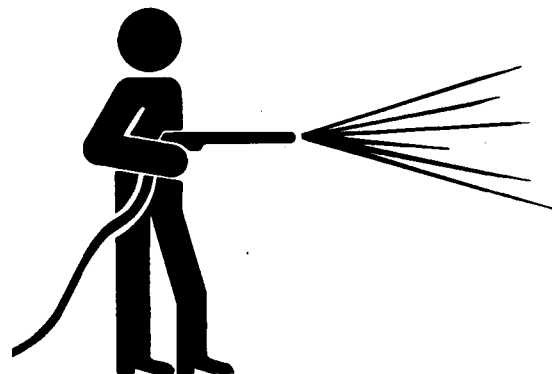

DX,CLEAN -19-04JUN90

T6642EJ -JUN-18OCT88

### SERVICE MACHINES SAFELY

Tie long hair behind your head. Do not wear a necktie, scarf, loose clothing, or necklace when you work near machine tools or moving parts. If these items were to get caught, severe injury could result.

Remove rings and other jewelry to prevent electrical shorts and entanglement in moving parts.

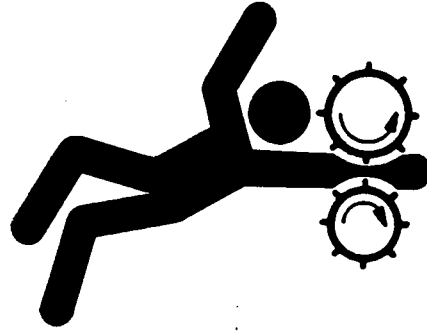

DX, LOOSE -19-04JUN90

TS228 -JUN-23AUG88

### ILLUMINATE WORK AREA SAFELY

Illuminate your work area adequately but safely. Use a portable safety light for working inside or under the machine. Make sure the bulb is enclosed by a wire cage. The hot filament of an accidentally broken bulb can ignite spilled fuel or oil.

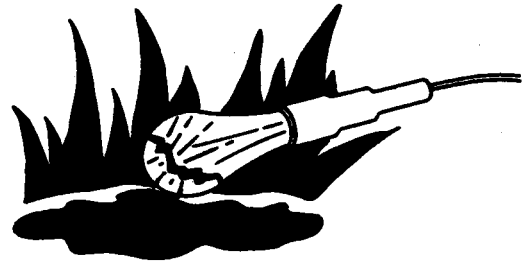

DX, LIGHT -19-04JUN90

TS223 -JUN-23AUG88

### REPLACE SAFETY SIGNS

Replace missing or damaged safety signs. See the machine operator's manual for correct safety sign placement.



DX, SIGNS1 -19-04JUN90

TS201 -JUN-23AUG88

### USE PROPER LIFTING EQUIPMENT

Lifting heavy components incorrectly can cause severe injury or machine damage.

Follow recommended procedure for removal and installation of components in the manual.

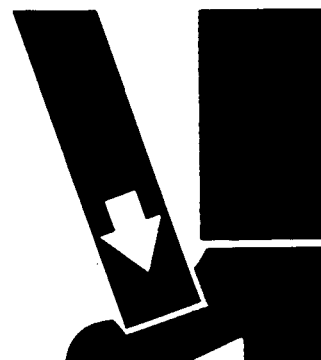

DX, LIFT -19-04JUN90

TS226 -JUN-23AUG88

## REMOVE PAINT BEFORE WELDING OR HEATING

Avoid potentially toxic fumes and dust.

Hazardous fumes can be generated when paint is heated by welding, soldering, or using a torch.

Do all work outside or in a well ventilated area. Dispose of paint and solvent properly.

Remove paint before welding or heating:

- If you sand or grind paint, avoid breathing the dust. Wear an approved respirator.
- If you use solvent or paint stripper, remove stripper with soap and water before welding. Remove solvent or paint stripper containers and other flammable material from area. Allow fumes to disperse at least 15 minutes before welding or heating.

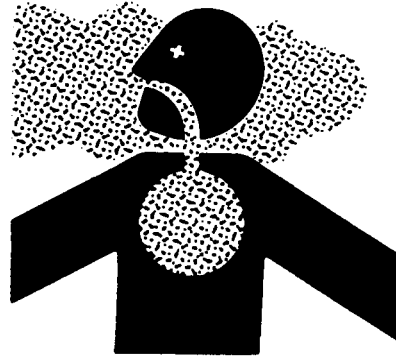

TS220 -JUN-23AUG88

DX,PAINT -19-03MAR93

## AVOID HEATING NEAR PRESSURIZED FLUID LINES

Flammable spray can be generated by heating near pressurized fluid lines, resulting in severe burns to yourself and bystanders. Do not heat by welding, soldering, or using a torch near pressurized fluid lines or other flammable materials. Pressurized lines can be accidentally cut when heat goes beyond the immediate flame area.



TSS63 -JUN-15MAY90

DX,TORCH -19-03MAR93

## SERVICE TIRES SAFELY

Explosive separation of a tire and rim parts can cause serious injury or death.

Do not attempt to mount a tire unless you have the proper equipment and experience to perform the job.

Always maintain the correct tire pressure. Do not inflate the tires above the recommended pressure. Never weld or heat a wheel and tire assembly. The heat can cause an increase in air pressure resulting in a tire explosion. Welding can structurally weaken or deform the wheel.

When inflating tires, use a clip-on chuck and extension hose long enough to allow you to stand to one side and NOT in front of or over the tire assembly. Use a safety cage if available.

Check wheels for low pressure, cuts, bubbles, damaged rims or missing lug bolts and nuts.

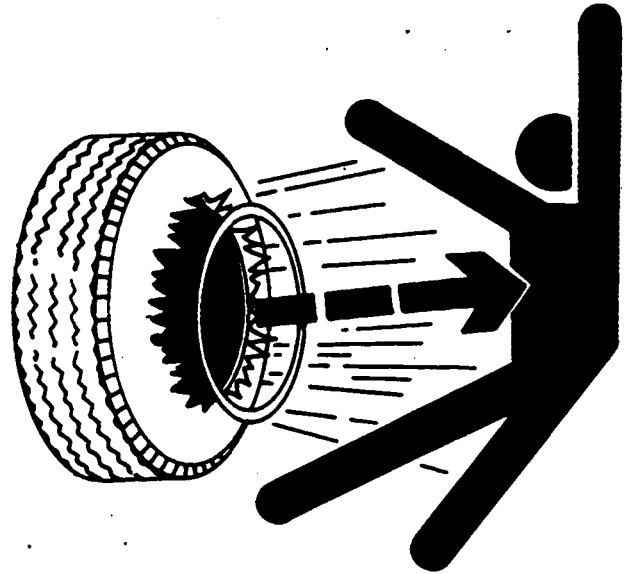

-JUN-23AUG88

TS211

DX,RIM -19-24AUG90

## PRACTICE SAFE MAINTENANCE

Understand service procedure before doing work. Keep area clean and dry.

Never lubricate, service, or adjust machine while it is moving. Keep hands, feet, and clothing from power-driven parts. Disengage all power and operate controls to relieve pressure. Lower equipment to the ground. Stop the engine. Remove the key. Allow machine to cool.

Securely support any machine elements that must be raised for service work.

Keep all parts in good condition and properly installed. Fix damage immediately. Replace worn or broken parts. Remove any buildup of grease, oil, or debris.

Disconnect battery ground cable (-) before making adjustments on electrical systems or welding on machine.



-JUN-23AUG88

TS218

DX,SERV -19-03MAR93

## USE PROPER TOOLS

Use tools appropriate to the work. Makeshift tools and procedures can create safety hazards.

Use power tools only to loosen threaded parts and fasteners.

For loosening and tightening hardware, use the correct size tools. DO NOT use U.S. measurement tools on metric fasteners. Avoid bodily injury caused by slipping wrenches.

Use only service parts meeting John Deere specifications.



TS779 -JUN-08NOV89

DX,REPAIR -19-04JUN90

## DISPOSE OF WASTE PROPERLY

Improperly disposing of waste can threaten the environment and ecology. Potentially harmful waste used with John Deere equipment include such items as oil, fuel, coolant, brake fluid, filters, and batteries.

Use leakproof containers when draining fluids. Do not use food or beverage containers that may mislead someone into drinking from them.

Do not pour waste onto the ground, down a drain, or into any water source.

Air conditioning refrigerants escaping into the air can damage the Earth's atmosphere. Government regulations may require a certified air conditioning service center to recover and recycle used air conditioning refrigerants.

Inquire on the proper way to recycle or dispose of waste from your local environmental or recycling center, or from your John Deere dealer.

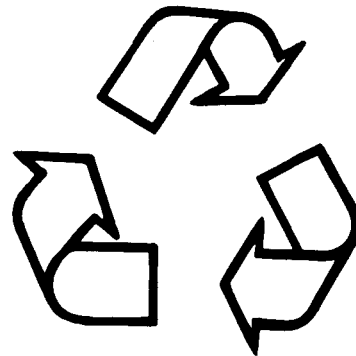

TS1133 -JUN-26NOV90

DX,DRAIN -19-03MAR93

**REMOVE FRONT POWERLINE**

Disconnect powerline from tractor PTO.

Remove cap screw (A) and disconnect powerline (B) from mower-conditioner.

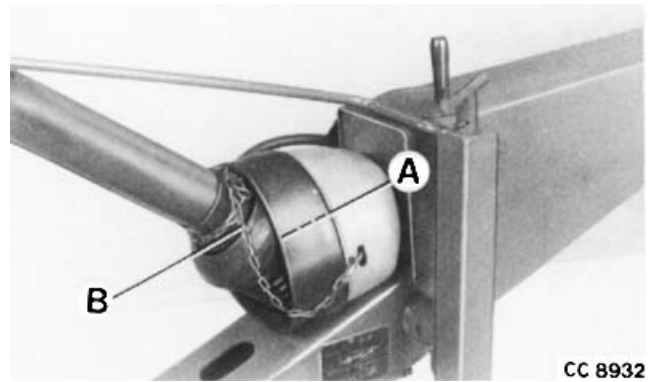

CC,TMMOCO000615-19-05APR93

**FRONT POWERLINE — EXPLODED VIEW (NORTH AMERICA)**

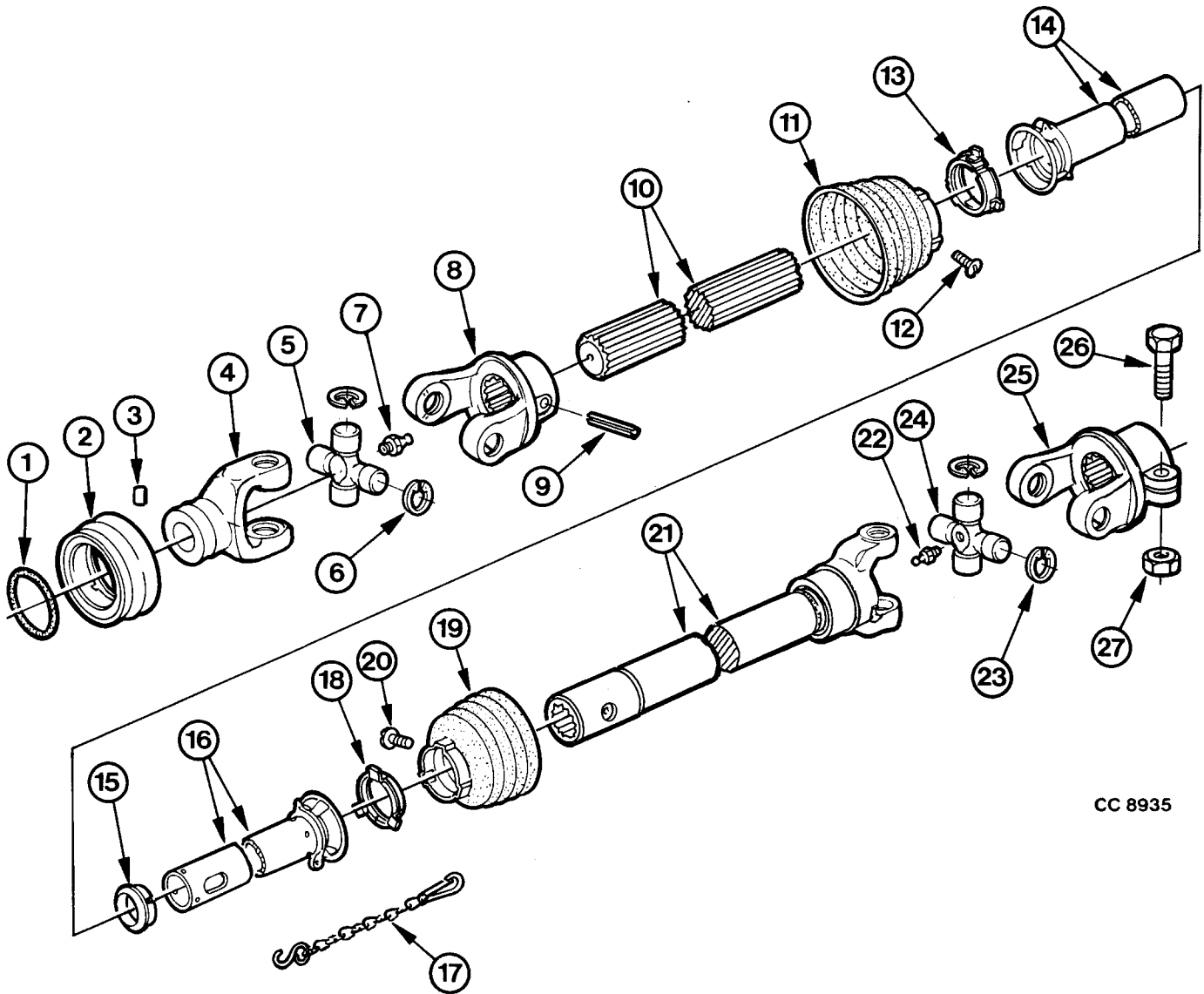

CC 8935

- 1—Snap ring
- 2—Coupler
- 3—Ball
- 4—Universal joint yoke
- 5—Cross and bearing assembly
- 6—Snap ring
- 7—Grease fitting

- 8—Universal joint yoke
- 9—Spring pin
- 10—Externally splined shaft
- 11—Cone
- 12—Locking screw
- 13—Bearing ring
- 14—Half guard
- 15—Guide

- 16—Half guard
- 17—Chain
- 18—Bearing ring
- 19—Cone
- 20—Locking screw
- 21—Yoke with internally splined shaft

- 22—Grease fitting
- 23—Snap ring
- 24—Cross and bearing assembly
- 25—Universal joint yoke
- 26—Cap screw
- 27—Nut

-JUN-24-MAR03  
CC8935

**FRONT POWERLINE — EXPLODED VIEW (EXCEPT NORTH AMERICA)**

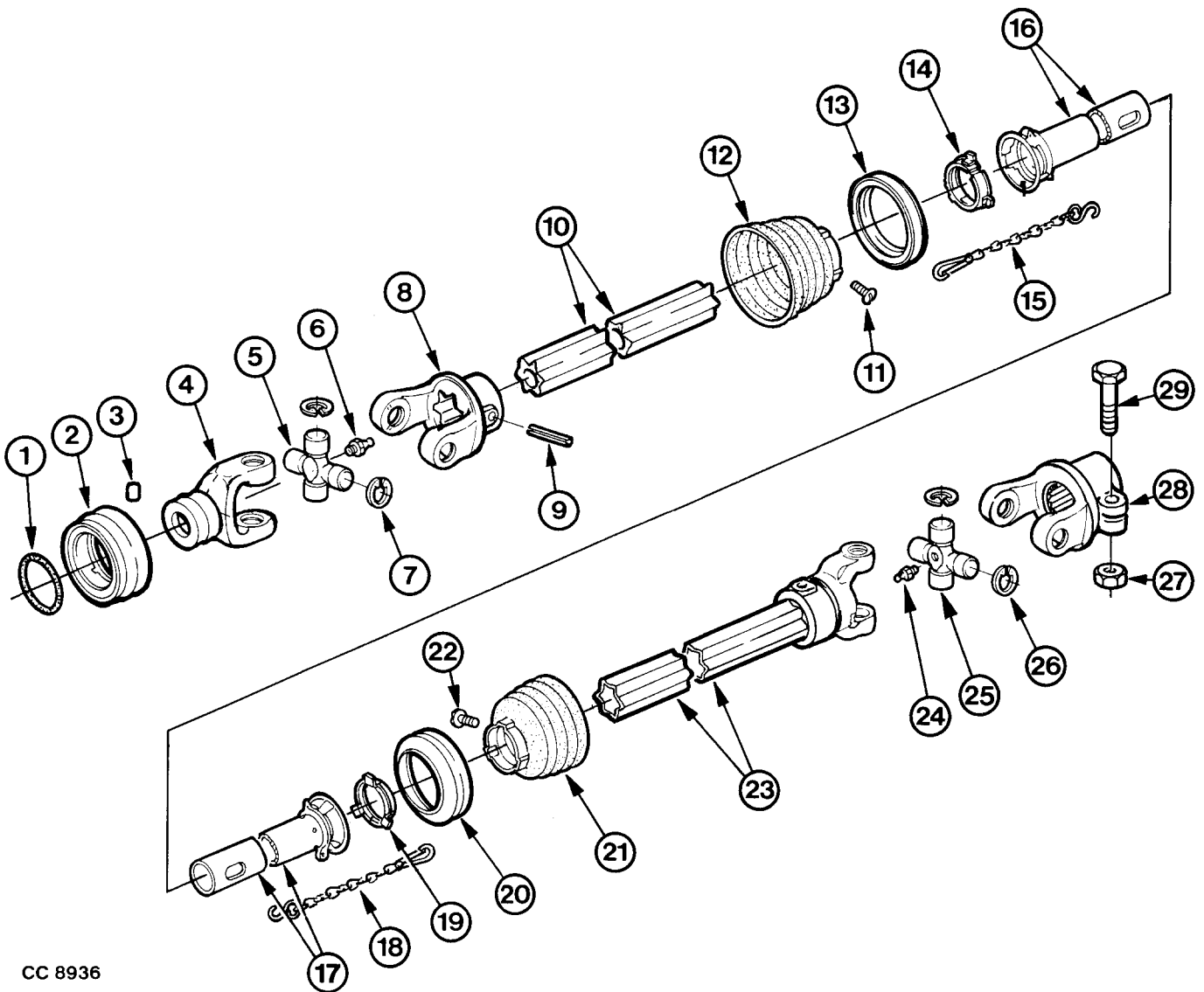

CC 8936

- 1—Snap ring
- 2—Coupler
- 3—Ball
- 4—Universal joint yoke
- 5—Cross and bearing assembly
- 6—Grease fitting
- 7—Snap ring

- 8—Universal joint yoke
- 9—Spring pin
- 10—Externally splined shaft
- 11—Locking screw
- 12—Cone
- 13—Cone stiffener
- 14—Bearing ring
- 15—Chain

- 16—Half guard
- 17—Half guard
- 18—Chain
- 19—Bearing ring
- 20—Cone stiffener
- 21—Cone
- 22—Locking screw
- 23—Externally splined shaft with yoke

- 24—Grease fitting
- 25—Cross and bearing assembly
- 26—Snap ring
- 27—Nut
- 28—Universal joint yoke
- 29—Cap screw

-JUN-24-MAR03  
CC8936

CC,TMMOCO000652-19-05APR93

### INSTALL FRONT POWERLINE

Reinstall front powerline (B) on shaft and insert cap screw (A).

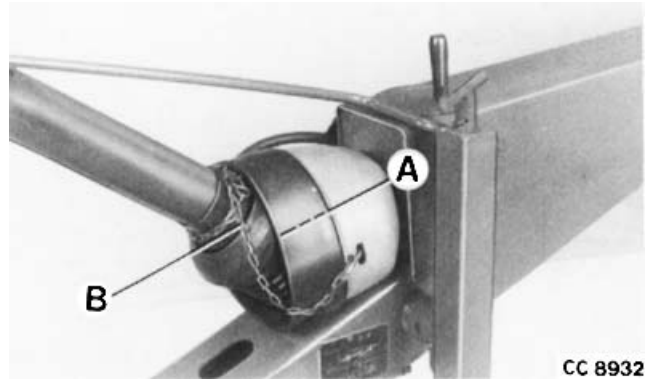

CC 8932

CC,TMMOCO000616-19-05APR93

-JUN-10APR03

CC8932

### REMOVE REAR POWERLINE

#### From Slip Clutch

Remove slip clutch shield, then pull back powerline shield (A).

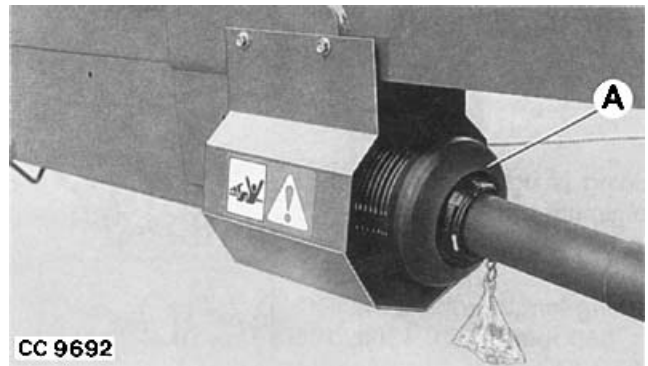

CC 9692

CC,TMMOCO000617-19-05APR93

-JUN-10APR03

CC9692

Remove the eight cap screws (A) from plate (B) and disconnect powerline.

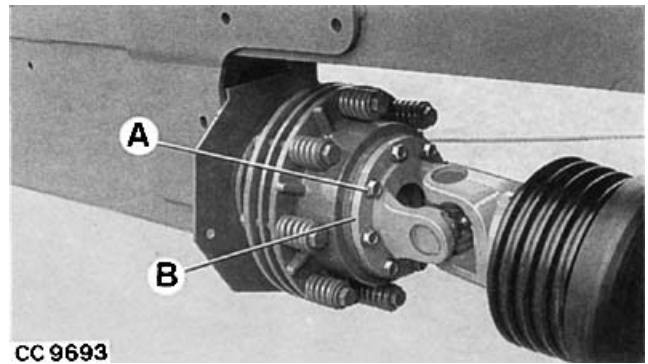

CC 9693

CC,TMMOCO000618-19-05APR93

-JUN-10APR03

CC9693

#### From Gear Case

Pull back cone (A).

Remove cap screw (B) and disconnect powerline (C).

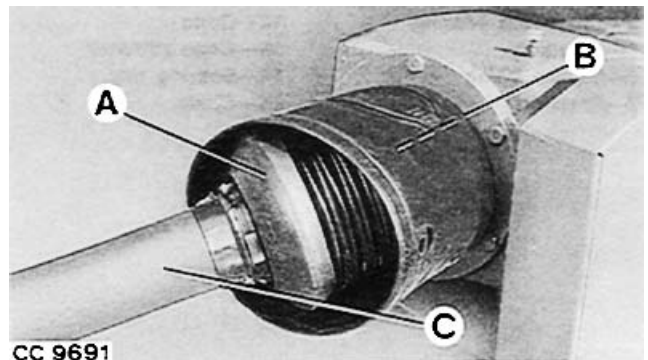

CC 9691

CC,TMMOCO000619-19-05APR93

-JUN-10APR03

CC9691

**REAR POWERLINE — EXPLODED VIEW (EXCEPT NORTH AMERICA)**

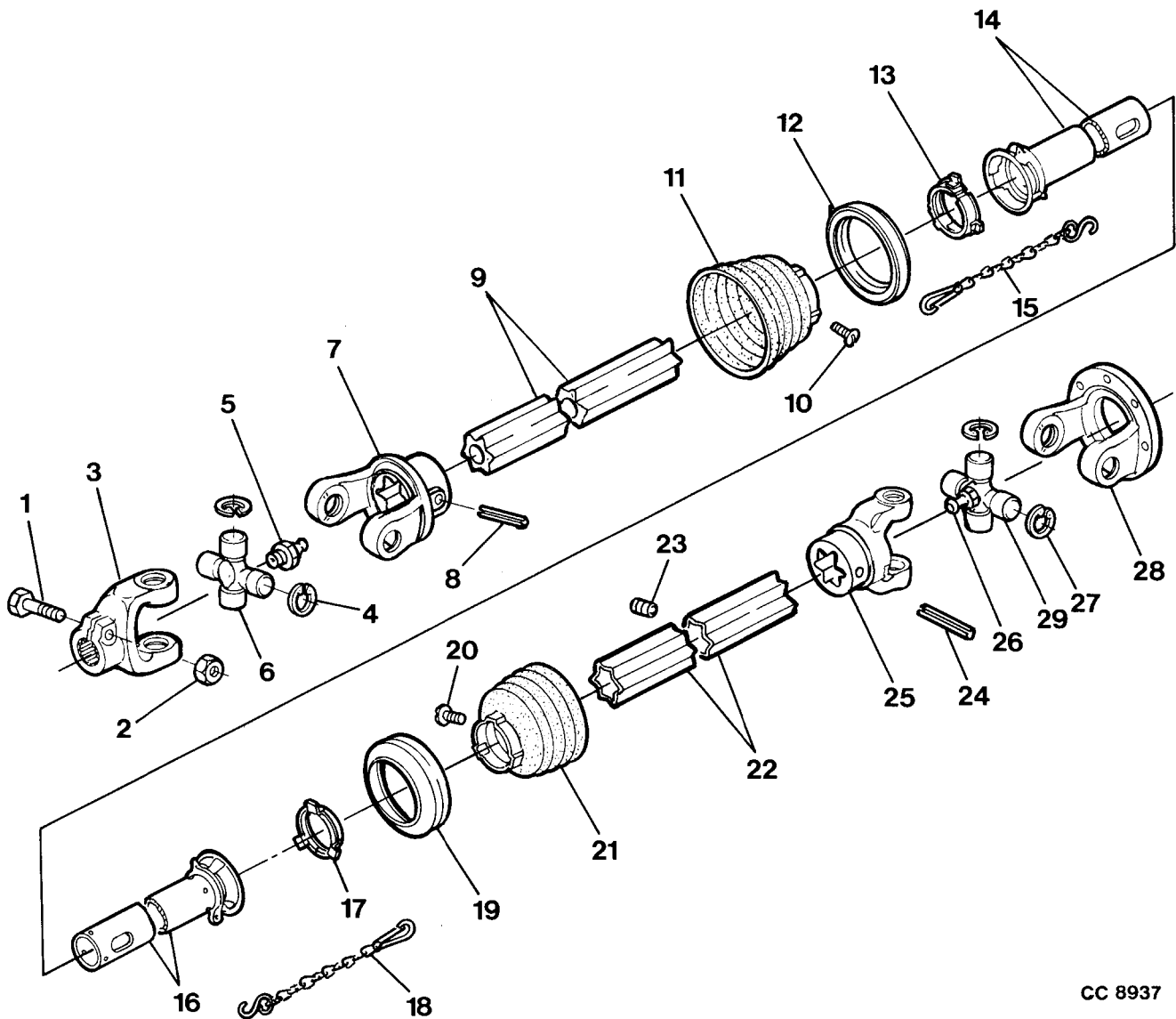

- 1—Cap screw
- 2—Nut
- 3—Universal joint yoke
- 4—Snap ring
- 5—Grease fitting
- 6—Cross and bearing assembly
- 7—Universal joint yoke

- 8—Spring pin
- 9—Externally splined shaft
- 10—Locking screw
- 11—Cone
- 12—Cone stiffener
- 13—Bearing ring
- 14—Half guard
- 15—Chain

- 16—Half guard
- 17—Bearing ring
- 18—Chain
- 19—Cone stiffener
- 20—Locking screw
- 21—Cone
- 22—Externally splined shaft
- 23—Grease fitting

- 24—Spring pin
- 25—Universal joint yoke
- 26—Grease fitting
- 27—Snap ring
- 28—Universal joint yoke
- 29—Cross and bearing assembly

CC 8937

CC8937  
-JUN-24/MAR03

CC.TMMOCO000653-19-05APR93

### INSTALL REAR POWERLINE

Reverse removal procedure.

Tighten the eight cap screws (A) on plate (B) to 70 Nm (50 lb-ft).

Reinstall slip clutch shield.

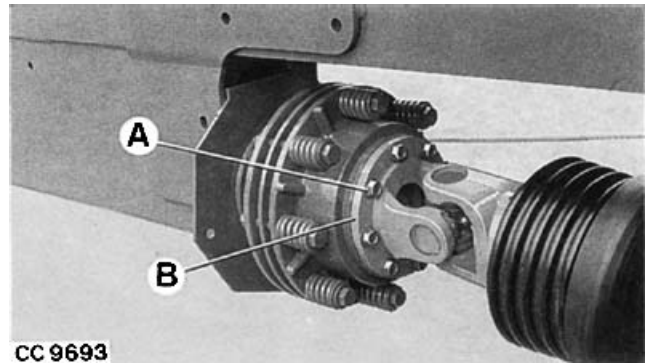

CC,TMMOCO000620-19-05APR93

### REMOVE HALF GUARD

Remove front and rear powerlines.

Remove locking screw (A).



CC,TMMOCO000621-19-05APR93

### Remove Half Guard

Turn cone (A) to position shown.



CC,TMMOCO000622-19-05APR93

Pull off half guard (A).

Remove bearing ring (B).

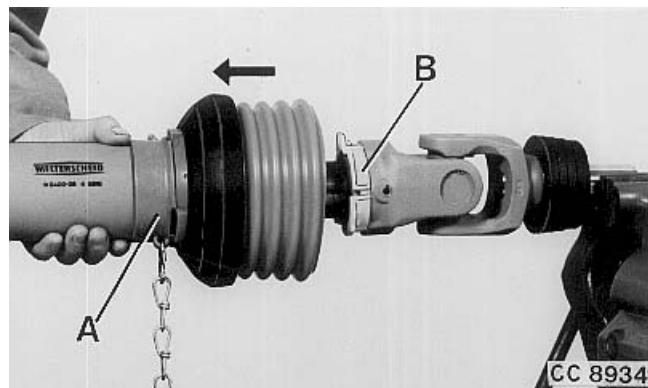

CC,TMMOCO000623-19-05APR93

## INSTALL HALF GUARD

### Grease Externally Splined Shaft

Grease bearing groove in yoke (A) and externally splined shaft (B).

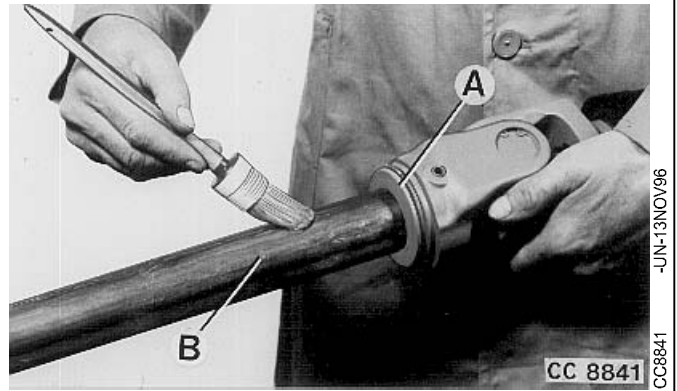

CC,TMMOCO000624-19-05APR93

### Install Bearing Ring

Place bearing ring (A) in groove (B) with tabs on side nearest to externally splined shaft.

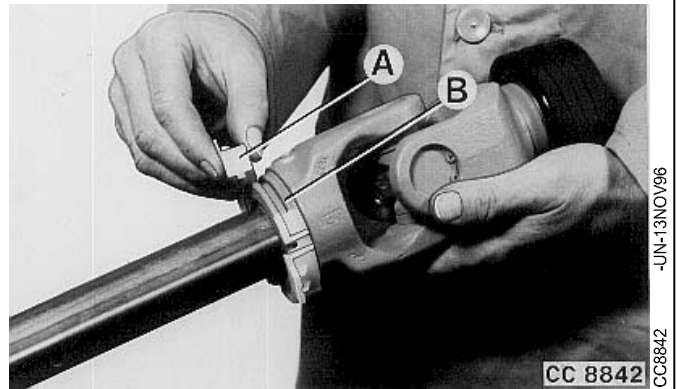

CC,TMMOCO000625-19-05APR93

### Install Half Guard

Push half guard over externally splined shaft.

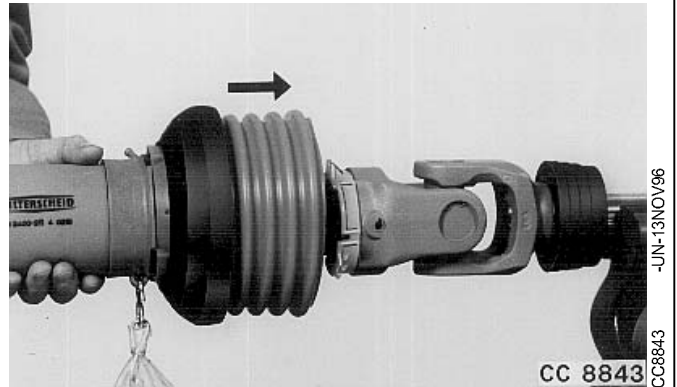

CC,TMMOCO000626-19-05APR93

### Lock Cone

Turn cone (A) to locking position.

Insert locking screw (B).

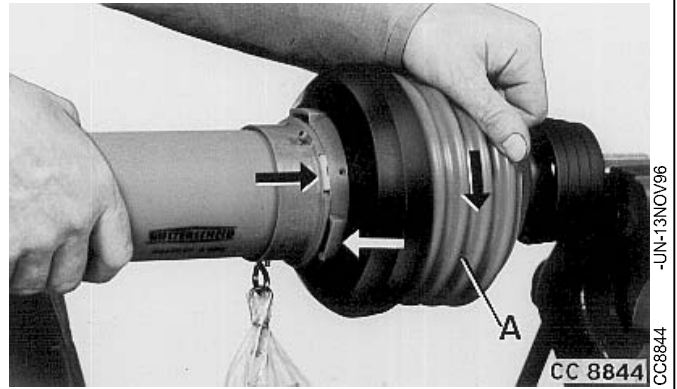

CC,TMMOCO000627-19-05APR93

### DISASSEMBLE HOOK-UP

Remove hook-up from machine.

Remove powerline guards.

Relieve strain on snap ring by tapping down end of universal joint cross with a hammer and drift punch.



CC,TMMOCO000628-19-05APR93

Remove snap ring (A) using snap ring pliers.

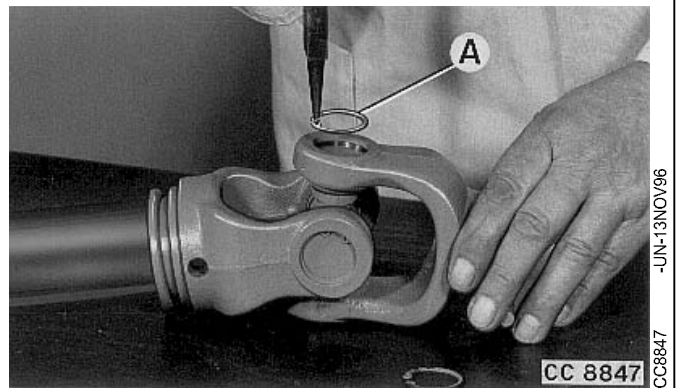

CC,TMMOCO000629-19-05APR93

Position universal joint (A) in vice as shown.

Tap lightly with a hammer on yoke of joint to drive up bearing bushing (B).

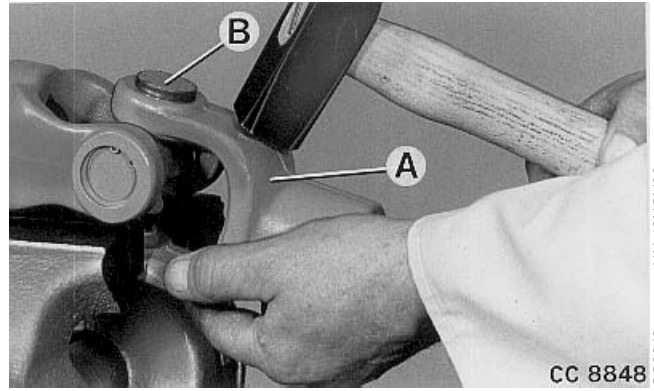

CC 8848  
CC,TMMOCO000630-19-05APR93

-JUN-13NOV96  
CC8848

Hold bearing bushing in special tool KJD10153 (A). Remove bearing bushing by tapping lightly on yoke (B) or by rotating yoke.

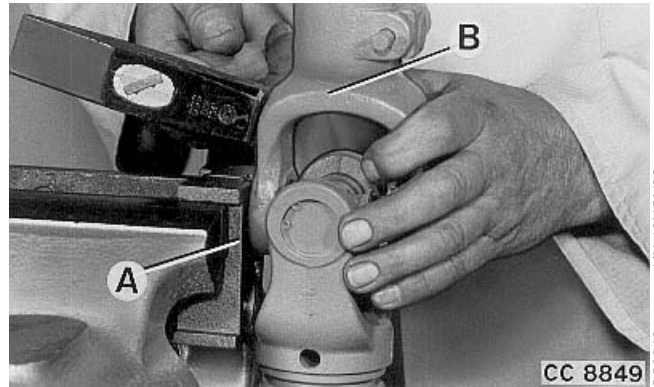

CC 8849  
CC,TMMOCO000631-19-05APR93

-JUN-13NOV96  
CC8849

Repeat process for each bearing bushing (A) to remove cross (B).

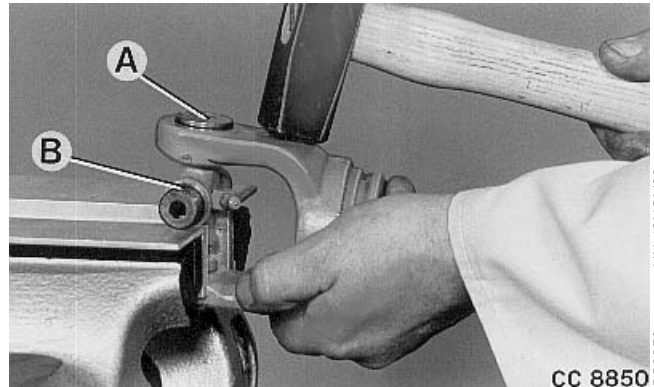

CC 8850  
CC,TMMOCO000632-19-05APR93

-JUN-13NOV96  
CC8850

## ASSEMBLE HOOK-UP

Insert cross (A) into yoke (B). Use cross journals to guide bearing needles when inserting bushings.

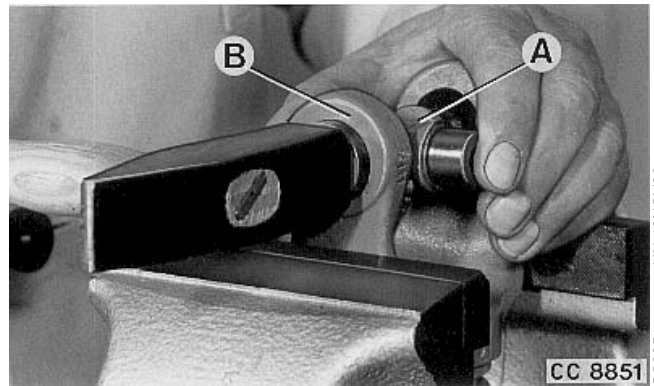

CC 8851  
CC,TMMOCO000633-19-05APR93

-JUN-13NOV96  
CC8851

Drive in bearing bushing until snap ring groove is visible.

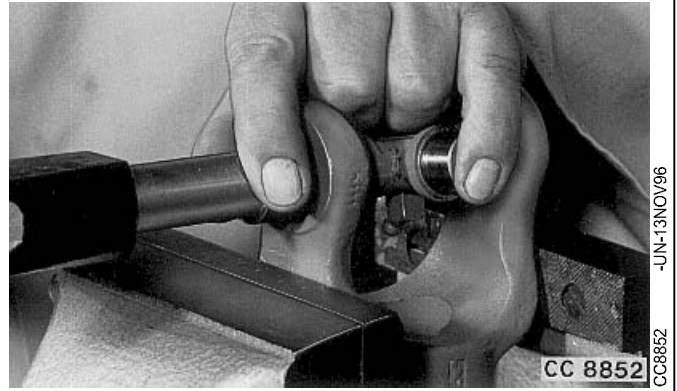

CC,TMMOCO000634-19-05APR93

-JUN-13NOV96  
CC8852

Fit snap ring (A).

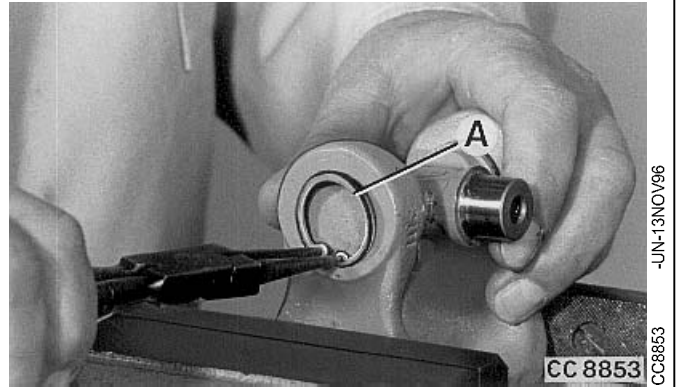

CC,TMMOCO000635-19-05APR93

-JUN-13NOV96  
CC8853

When installing second yoke (A), ensure that grease fitting (B) is easily accessible.

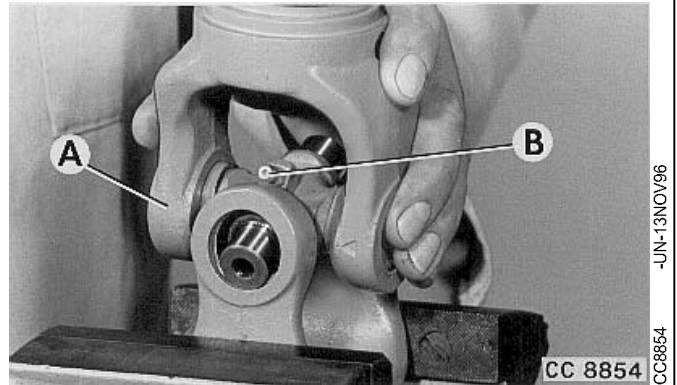

CC,TMMOCO000636-19-05APR93

-JUN-13NOV96  
CC8854

Relieve stress in joint by tapping lightly on yoke ear (A) with a hammer.

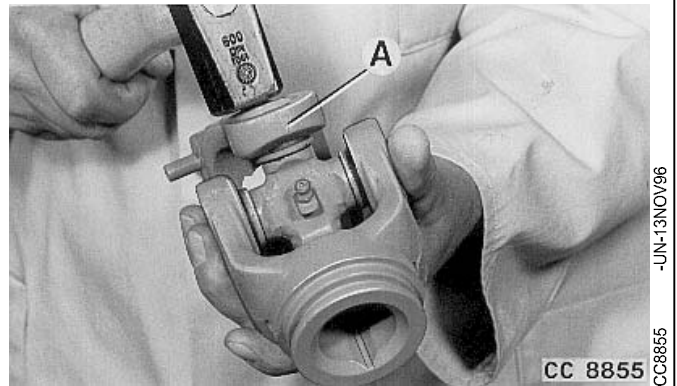

CC,TMMOCO000637-19-05APR93

-JUN-13NOV96  
CC8855



**Suggest:**

**If the above button click is invalid.**

**Please download this document**

**first, and then click the above link**

**to download the complete manual.**

**Thank you so much for reading**

Grease joint (A) with specified grease.

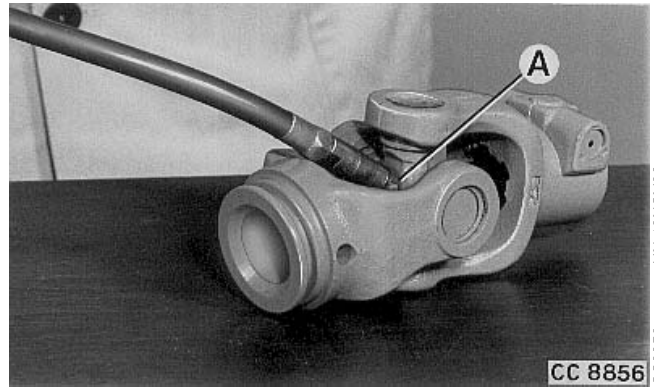

CC,TMMOCO000638-19-05APR93

## DISASSEMBLE COUPLER (NORTH AMERICA)

Remove front powerline.

Remove powerline guard.

CC,TMMOCO000639-19-05APR93

## Remove Snap Ring

Clamp powerline in a vice, holding it at yoke.

**IMPORTANT: Powerline should never be clamped at coupler.**

Remove snap ring (A).

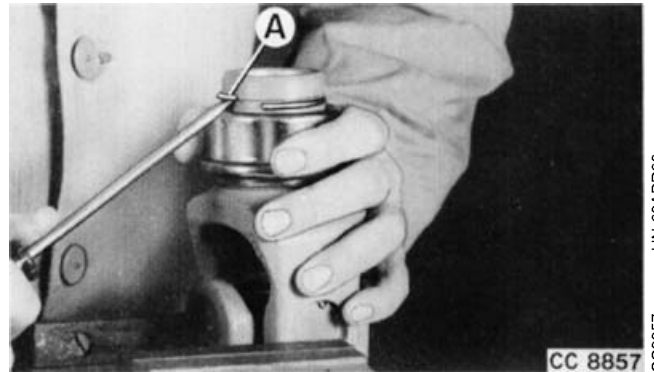

CC,TMMOCO000640-19-05APR93

## Remove Coupler

Remove coupler (A) and take out balls (B).

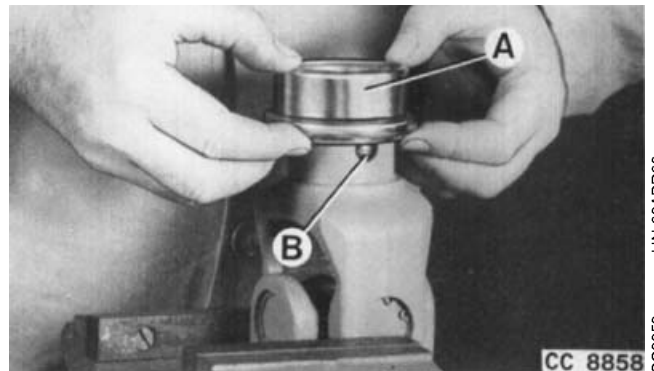

CC,TMMOCO000641-19-05APR93

**<https://www.ebooklibonline.com>**

Hello dear friend!

Thank you very much for reading.

Enter the link into your browser.

The full manual is available for immediate download.

**<https://www.ebooklibonline.com>**