

Impeller Mower-Conditioners 1326 and 1327



JOHN DEERE

TECHNICAL MANUAL Impeller Mower-Conditioners 1326 and 1327

TM3260 (01Jun86) English

John Deere Arc-lès-Gray
TM3260 (01Jun86)

LITHO IN U.S.A.
ENGLISH



**1326 – 1327 MOWER CONDITIONERS
TECHNICAL MANUAL
TM 3260 (JUNE-86)**

CONTENTS OF THIS MANUAL IN SECTIONS AND GROUPS

10 – GENERAL

05 – Introduction
10 – Specifications

50 – POWER TRAIN – REPAIR

05 – Powerline
10 – Slip clutch
20 – Gear case

100 – CUTTING COMPONENTS – REPAIR

05 – Disks
10 – Cutterbar

110 – HYDRAULIC SYSTEM – REPAIR

05 – Lift cylinders

© by Deere & Co.; European Office
D-6800 Mannheim

All information, illustrations and specifications contained in this technical manual are based on the latest information available at the time of publication. The right is reserved to make changes at any time without notice.

TABLEMAT-CCL101AE-200885

Section 10 GENERAL

CONTENTS OF THIS SECTION IN GROUPS

05 – INTRODUCTION

Service literature	10-05-1
Safety	10-05-2
General recommendations for disassembly and inspection	10-05-2

10 – SPECIFICATIONS

General specifications	10-10-1
General torques for hardware	10-10-1
Locking collars for shaft bearings	10-10-2
Lubrication	10-10-2

GENERAL-CCL11001AE-200885

<https://www.ebooklibonline.com>

Hello dear friend!

Thank you very much for reading.

Enter the link into your browser.

The full manual is available for immediate download.

<https://www.ebooklibonline.com>

SERVICE LITERATURE

This technical manual is part of a twin concept of service.

FOS Manuals – for reference

Technical Manuals – for actual service

The two kinds of manuals work as a team to give you both the general background and technical details of shop service.

Fundamentals of Service (FOS) Manuals cover basic theory of operation, fundamentals of trouble shooting, general maintenance, and basic types of failures and their causes. FOS manuals are for training new people and for reference to experienced technicians.

Some features of this technical manual:

Table of contents at front of manual

Exploded views showing parts relationship

Photos showing service techniques

This technical manual was planned and written for you – an experienced technician. Keep it in a permanent binder in the shop where it is handy. Refer to it whenever in doubt about correct service procedures or specifications.

Using the technical manual as a guide will reduce error and costly delay. It will also assure you the best in finished service work.

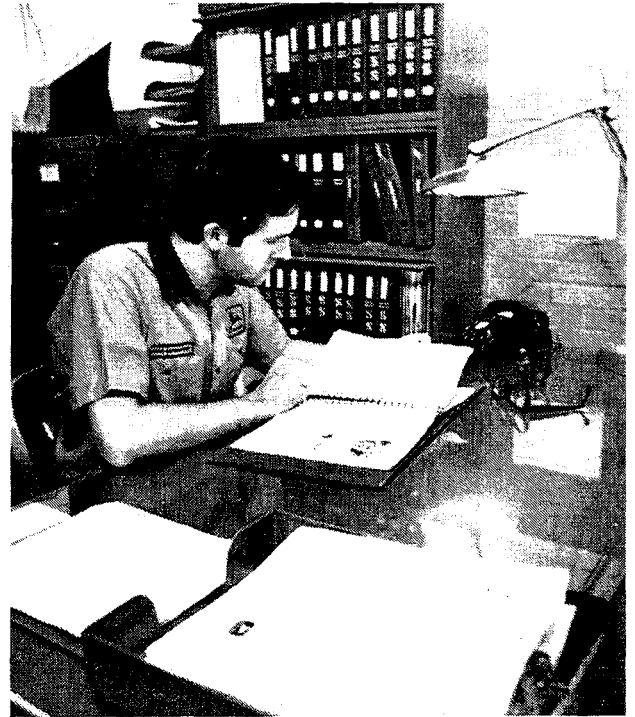

X2252N,X2253N-CCL11005AE-200885

SAFETY

Operator's Manuals of the relevant machines contain SAFETY rules for operation and service. Practice them to avoid ACCIDENTS.

RECOMGENE-CCL11005AE-200885

GENERAL RECOMMENDATIONS FOR DISASSEMBLY AND INSPECTION

A good working organization as well as clean tools and work bench are a must for proper repair and service.

Use adequate tools, check all parts for serviceability and replace them if necessary.

Refer to relevant FOS Manuals for diagnosing component problems.

Follow given specifications and refer to Operator's Manual for safety procedures.

Use exploded views to identify parts.

Before commencing reassembly, make sure all parts (including replacements) are available on your work bench.

RECOMGENE-CCL11005BE-200885

GENERAL SPECIFICATIONS

Refer to the operator's manual of the relevant machine.

SPECGENE-CCL11010AE-200885

GENERAL TORQUES

METRIC MEASUREMENT

Bolt Diameter (A)	Bolt Torque in Nm (ft-lb)	
	8.8	10.9
5 mm	7 (5)	9 (6.5)
6 mm	10 (8.5)	15 (10)
8 mm	30 (20)	40 (30)
10 mm	50 (35)	80 (60)
12 mm	100 (75)	140 (100)
14 mm	160 (120)	210 (155)
16 mm	240 (175)	350 (260)
20 mm	480 (355)	650 (480)
24 mm	820 (605)	1150 (850)
30 mm	1640 (1210)	2250 (1660)

NOTE: Bolts having lock nuts should be torqued to approximately 65% of amounts shown in above chart.

This chart gives the recommended torques for hardware. Refer to this chart when no specified torque is mentioned in assembly procedures.

SPECGENE-CCL11005BE-200885

LOCKING COLLARS FOR SHAFT BEARINGS

Locking collars (A) on bearings (B) must be kept tight at all times.

On rotating shafts (C), locking collars (A) will have to be secured in the direction of shaft rotation.

On stationary shafts (D), locking collars (A) will have to be secured in the opposite direction of bearing (B) rotation.

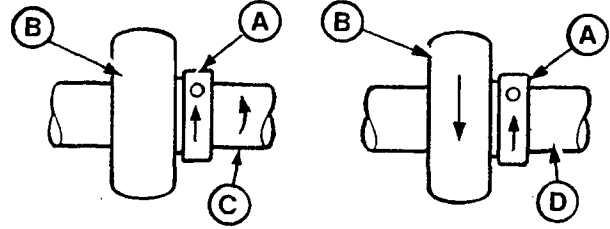

CC 2636

A—Locking collar

C—Rotating shaft

B—Bearing

D—Stationary shaft

CC2636-CCL11010AE-200885

LUBRICATION

Quality of lubricant to be used and lubrication periods depend upon operating conditions.

IMPORTANT: Refer to lubrication section of the Operator's Manual for procedure, proper oil specifications and recommended grease.

SPECGENE-CCL11020CE-200885

Section 50 POWER TRAIN – REPAIR

CONTENTS OF THIS SECTION IN GROUPS

05 – POWERLINE

POWR-Gard PTO disassembly	50-05-1
POWR-Gard PTO reassembly	50-05-5
BONDIOLI PTO disassembly	50-05-8
BONDIOLI PTO shield disassembly	50-05-8
BONDIOLI PTO shield reassembly	50-05-9
BONDIOLI PTO hookup disassembly	50-05-10
BONDIOLI PTO hookup reassembly	50-05-11

10 – SLIP CLUTCH

Specifications	50-10-1
Description	50-10-1
Slip clutch removal and disassembly	50-10-2
Slip clutch inspection	50-10-4
Slip clutch reassembly and reinstallation	50-10-4
Adjusting slip clutch	50-10-5

20 – GEAR CASE

Special tools	50-20-1
Self-manufactured tools	50-20-2
Specifications	50-20-3
Assembly accessories	50-20-4
Torques for hardware	50-20-5

1326 Gear case	
Gear case removal	50-20-10
Gear case reinstallation	50-20-11
Primary drive removal	50-20-14
Primary drive reinstallation	50-20-15
Primary drive disassembly	50-20-15
Primary drive reassembly	50-20-16
Cutterbar drive removal	50-20-18
Cutterbar drive reinstallation	50-20-18
Cutterbar drive disassembly	50-20-19
Cutterbar drive reassembly	50-20-20
Impeller drive removal	50-20-21
Impeller drive reinstallation	50-20-22
Impeller drive disassembly	50-20-24
Impeller drive reassembly	50-20-24
Spiral bevel gear adjustment	50-20-25
Impeller bevel gear adjustment	50-20-26

1327 Gear case	
Gear case removal	50-20-27
Gear case reinstallation	50-20-28
Cutterbar drive removal	50-20-29
Cutterbar drive reinstallation	50-20-30
Cutterbar drive disassembly	50-20-30
Cutterbar drive reassembly	50-20-30
Primary drive removal	50-20-30
Primary drive reinstallation	50-20-33
Primary drive disassembly	50-20-33
Primary drive reassembly	50-20-34
Impeller drive removal	50-20-35
Impeller drive reinstallation	50-20-35
Impeller drive disassembly	50-20-35
Impeller drive reassembly	50-20-35
Spiral gear adjustment	50-20-36
Bevel gear adjustment	50-20-36

POWR-GARD PTO DISASSEMBLY

The 1326-1327 mower conditioners are equipped with a front and a rear power line. Disassembly and re-assembly processes are identical for both parts.

 **CAUTION:** Never connect a 540 rpm mower-conditioner to a 1000 rpm tractor.

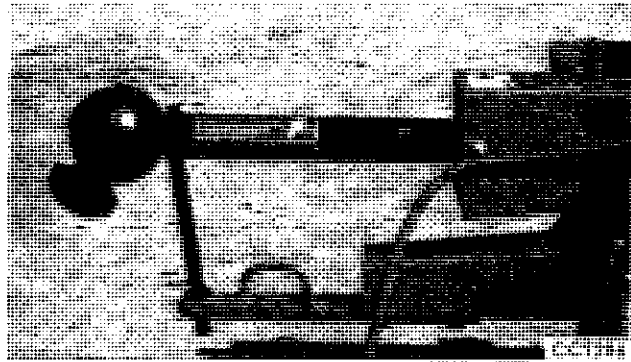

CC7296-CCL15005AE-200885

Remove PTO Shield

Remove hose clamp (A).

Remove the four cap screws (B).

Remove PTO shield (C).

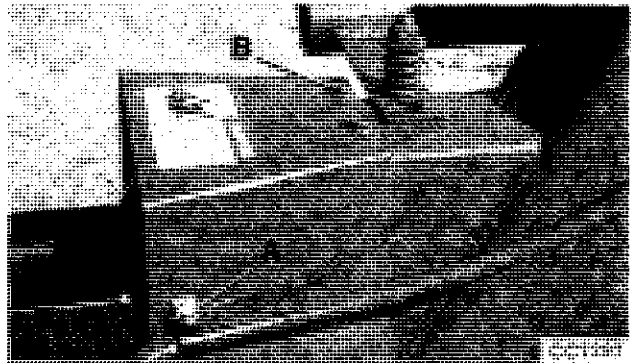

CC7297-CCL15005AE-200885

Remove PTO Hookup

Remove cap screw (A) and PTO hookup.

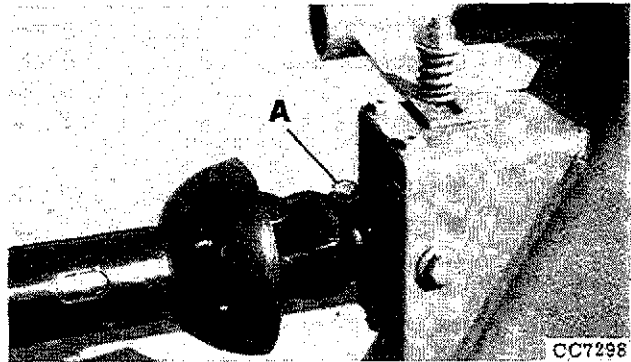

CC7298-CCL15005AE-200885

Disassemble POWR-GARD PTO

Support push collar assembly (B) and remove snap ring (A).

Remove push collar and pushbutton latch.

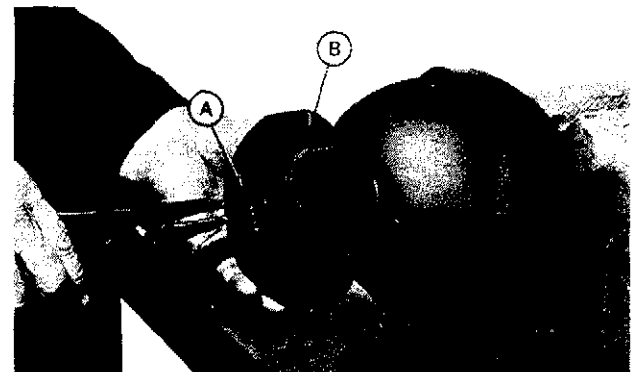

E12122-CCL15005AE-200885

Push back on retainer collar, remove three steel balls (A) from yoke, remove retainer collar (B) and spring (C).

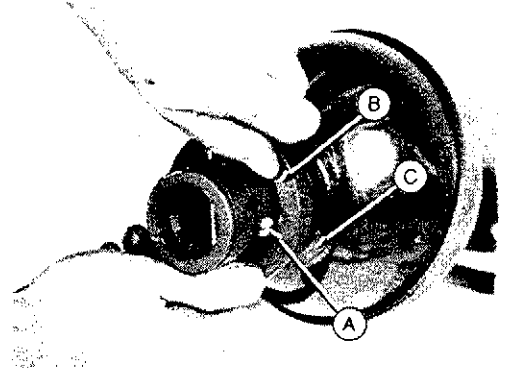

E18306-CCL15005AE-200885

Lift locking bearings (A) up and out of assembly. Remove closure shield from yoke.

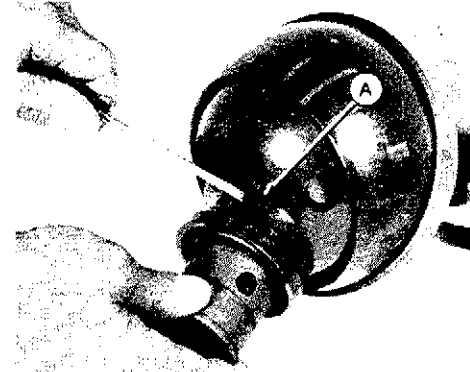

E18307-CCL15005AE-200885

Hold in vise, positioned so shaft can't slip out.
Remove locking bearings (A) from shield.
Remove yoke and shaft assembly (B) from shield.



E18308-CCL15005AE-200885

Note position of grease fitting (A) prior to disassembly so it can be properly positioned during reassembly.

Remove snap rings (B) from outside.

If snap rings stick, loosen by tapping lightly on ends of bearings with a soft brass hammer or soft brass rod.

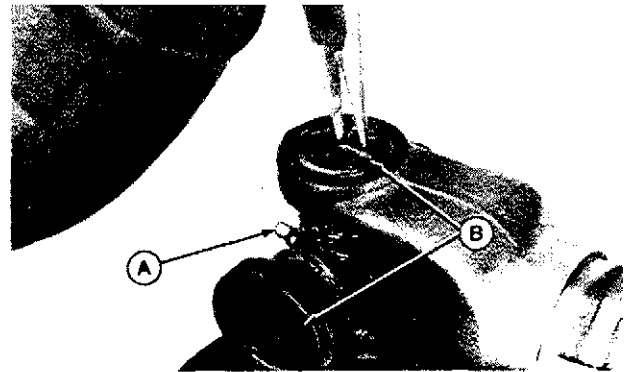

E18525-CCL15005AE-200885

Position joint in an open vise with each ear of one yoke supported by a vise jaw.

With a soft hammer or mallet, strike the top ear of the unsupported yoke. This will drive the top bushing outward approximately 9.5 mm (3/8 in.).

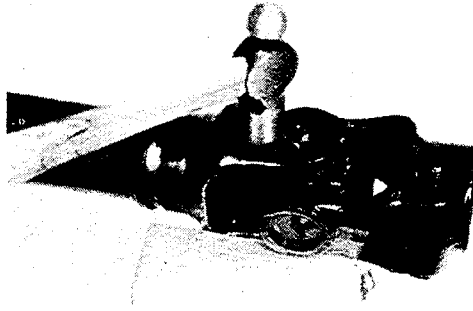

E19272-CCL15005AE-200885

Clamp loosened bearing in vise and drive yoke off.

Repeat this procedure for removing bearing directly opposite the one just removed, after which the yoke itself may be removed.

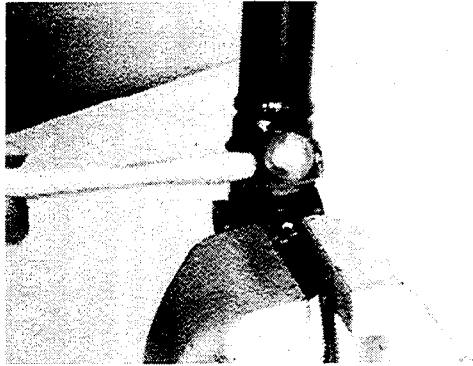

E19273-CCL15005AE-200885

To remove remaining two bushings, support cross as shown making certain that vise jaws are covered with brass protectors. By striking yoke ear, the remaining bushings can be removed as described above.

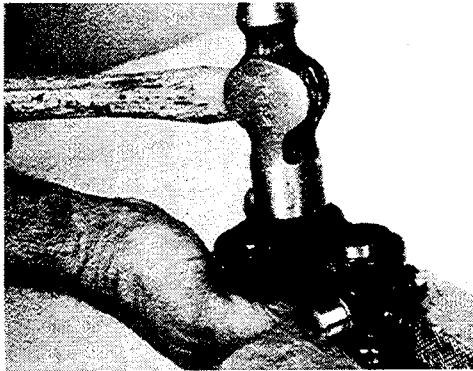

E19274-CCL15005AE-200885

Disassemble rear section of powershaft in same manner as front section.

Remove nylon bearing (A) from yoke and tube (B).

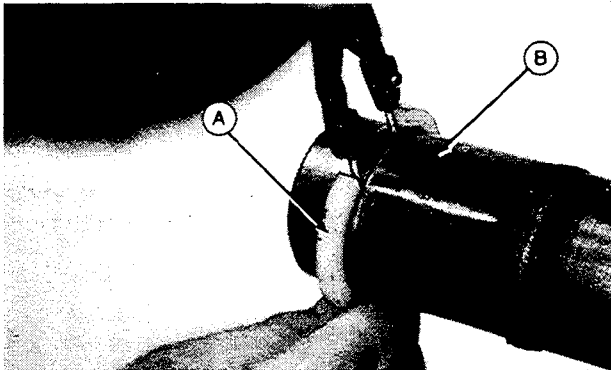

E18297-CCL15005AE-200885

POWR-GARD PTO INSPECTION

1. Clean rust, dirt and paint from cap holders.
2. Replace spider and bearing assembly, if worn.



CAUTION: Do not start tractor while inspecting shaft for straightness.

3. Check yoke and tube, yoke and shaft for straightness using dial indicator (A). Max. run-out should be 0.90 mm (0.35 in.) in middle of hookup. If hookup is out of tolerance, straighten or replace.

4. Check shaft for roughness, nicks or pitting of surface.
5. Replace compression springs if cracked or rusted.
6. Replace nylon locking bearings if worn.

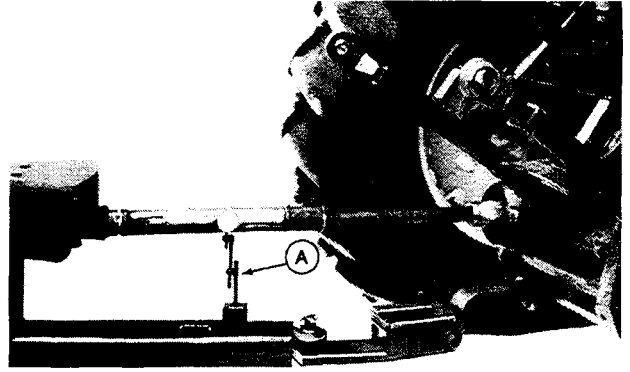

E21509-2015ZAH-260885

POWR-GARD PTO – EXPLODED VIEW

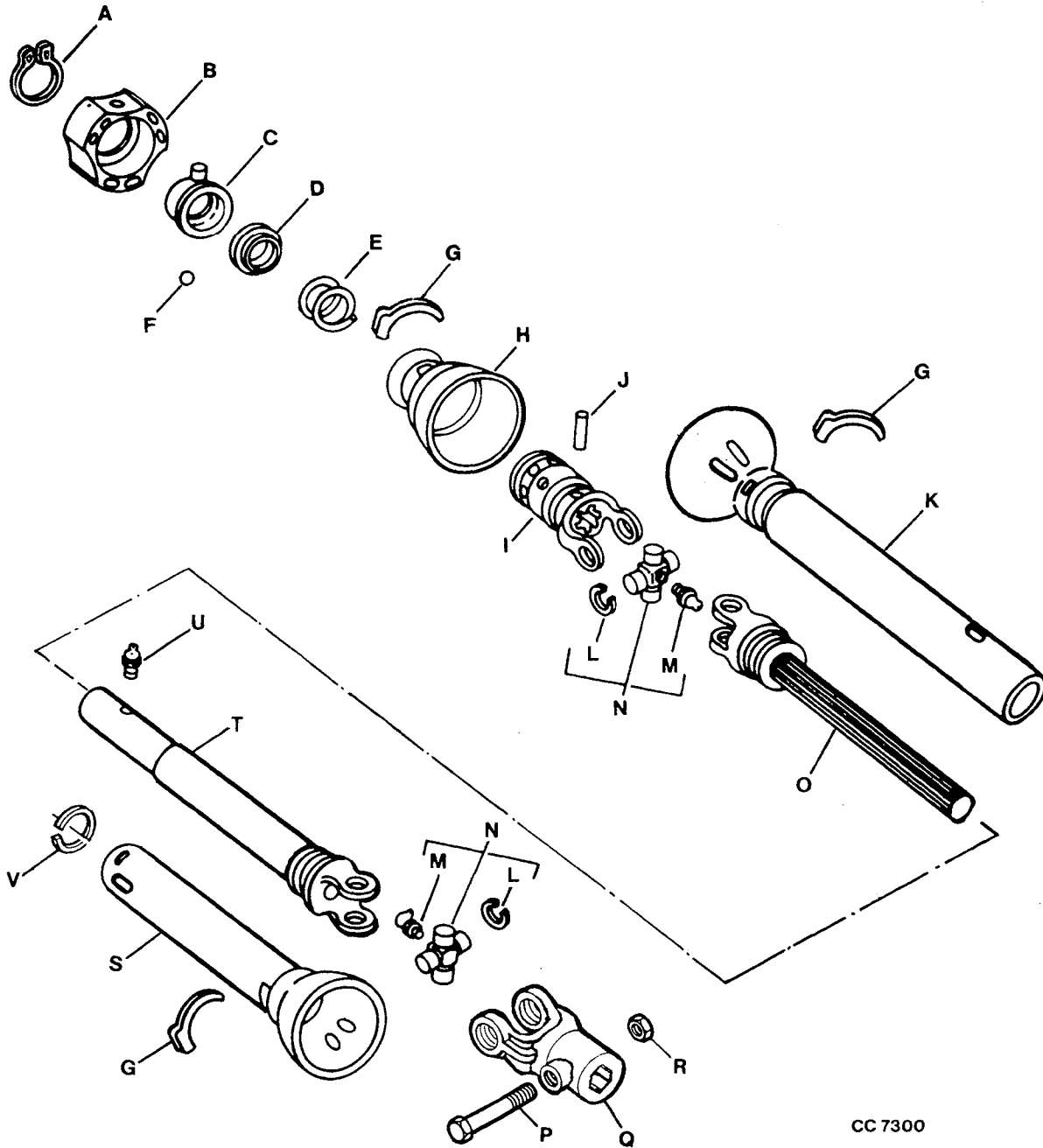

CC 7300

A-Snap ring
 B-PTO shield
 C-Latch
 D-Retainer
 E-Spring
 F-Ball

G-Universal joint bearing
 H-PTO shield
 I-Universal joint yoke
 J-Spring pin
 K-Powershaft shield
 L-Snap ring

M-Lubrication fitting
 N-Cross and bearing assembly
 O-Yoke with shaft
 P-Cap screw
 Q-Universal joint yoke
 R-Nut

S-Powershaft shield
 T-Yoke with shaft
 U-Lubrication fitting
 V-Guide

CC7300-CCL15005AE-20085

POWR-GARD PTO REASSEMBLY

Reassemble joints. Start one bearing in yoke.
Position center spider (A) through yoke.

Press bearing into yoke until flush with surface.

Clamp yoke in vise. Use a punch or socket with slightly smaller diameter than that of bearing and press bearing past snap ring groove.

Install snap ring (B).

Position cross and install bearing on opposite side.

Properly position grease fitting to allow greasing before installing third and fourth bearing.

Assemble remaining bearings and lubricate.

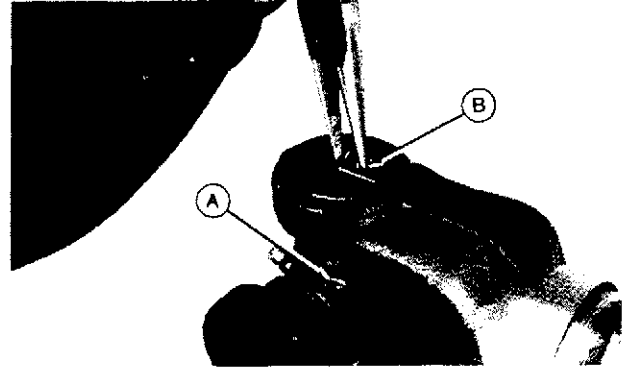

E18289-CCL15005AE-200885

If joint is stiff and does not flex freely after assembling, strike each ear of yoke on radius (A) to relieve pressure.

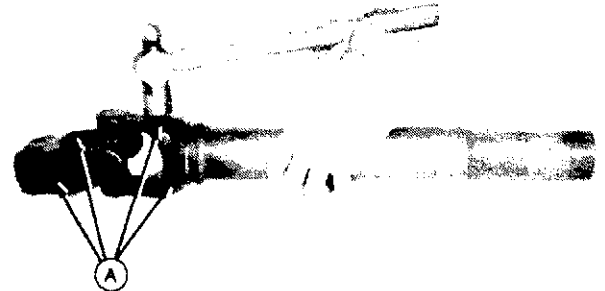

E18749-CCL15005AE-200885

Install closure shield assembly (A), shield (B) and shield bearings.

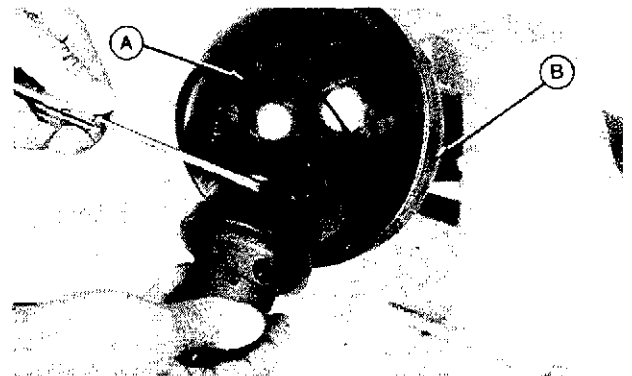

E18300-CCL15005AE-200885

NOTE: Apply grease to bearing grooves.

Install bearings (A) to retain shield as shown.

A—Locking bearings
B—Direction of shaft rotation

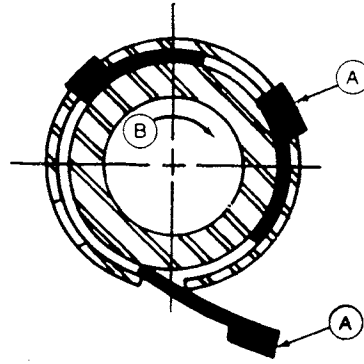

E18303-CCL15005AE-200885

Install spring (A), retainer collar (B), and steel balls on yoke.

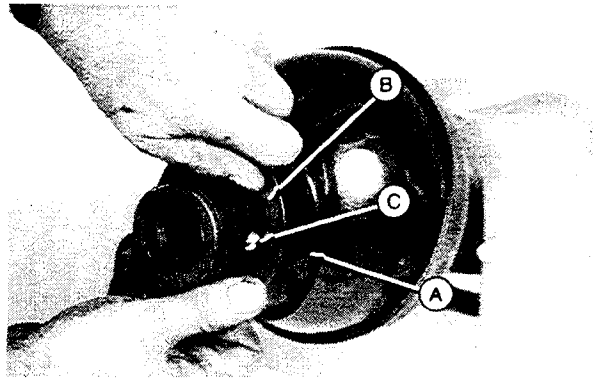

E18301-CCL15005AE-200885

Slide push button collar assembly (B) on yoke and secure with snap ring (A).

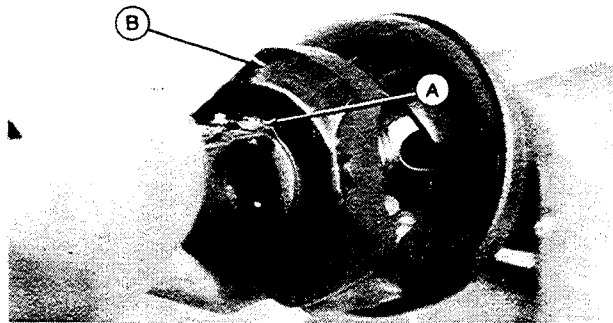

E18302-CCL15005AE-200885

POWR-GARD PTO REINSTALLATION

Reverse POWR-GARD PTO removal and disassembly steps for reinstallation.

ARBRES-CCL15005AE-200885

BONDIOLI PTO DISASSEMBLY

1326 and 1327 mower-conditioners are equipped with a front and a rear power line. Disassembly and re-assembly processes are identical for both parts.



CAUTION: Never connect a 540 rpm mower-conditioner to a 1000 rpm tractor.

APBRES-CCL15005BE-200885

Remove PTO Shield

Remove hose clamp (A).

Remove the two upper and lower cap screws (B).

Remove drive shield (C).

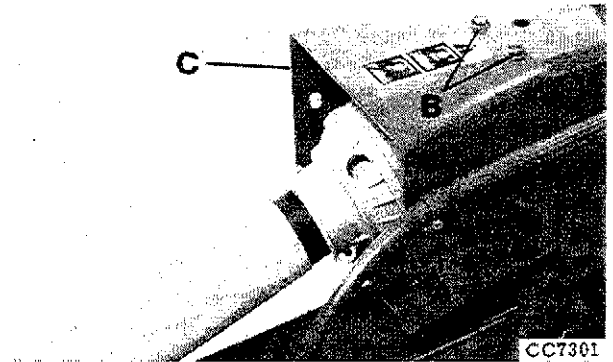

CC7301

CC7301-CCL15005AE-200885

Remove PTO Hookup

Remove cap screw (A) and PTO hookup.

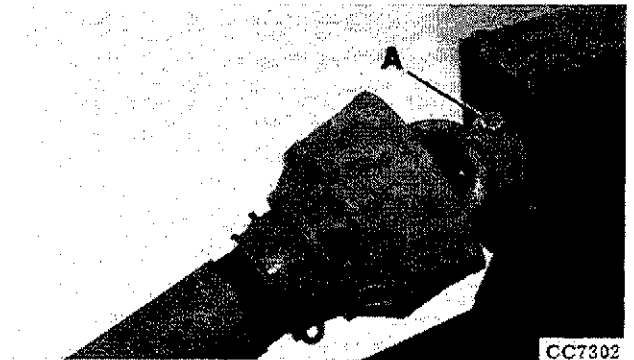

CC7302

CC7302-CCL15005AE-200885

PTO SHIELD DISASSEMBLY

Keep cone pressed downward and release catches by pushing with a screwdriver.



CC7303

CC7303-CCL15005AE-200885

Remove Half Tube

Open bearing ring to remove half tube.



CC7304-CCL15005AE-200885

PTO SHIELD REASSEMBLY

Grease bearing ring groove.

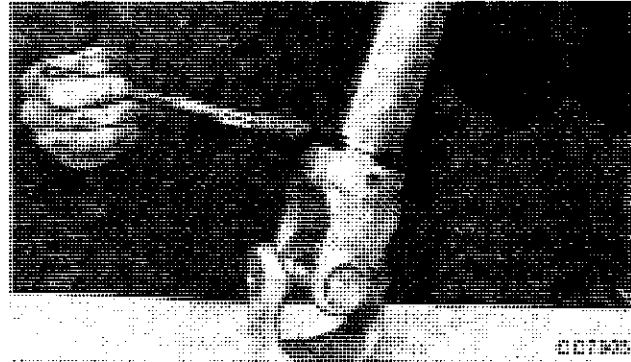

CC7305-CCL15005AE-200885

Reinstall Shield Tube

Fit shield tube onto bearing ring by centering the holes over the catches.



CC7306-CCL15005AE-200885

Reinstall Cone Shield

Fit cone centering grease fitting to grease filling hole on bearing ring. Press to connect.

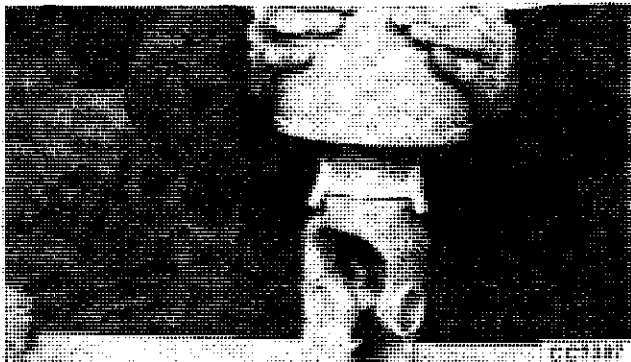

CC7307-CCL15005AE-200885

Check Assembly

Make sure that catches are properly engaged by tapping on cone.



CC7308

CC7308-CCL15005AE-200885

PTO HOOKUP DISASSEMBLY

Remove PTO shield.

Press on snap ring.

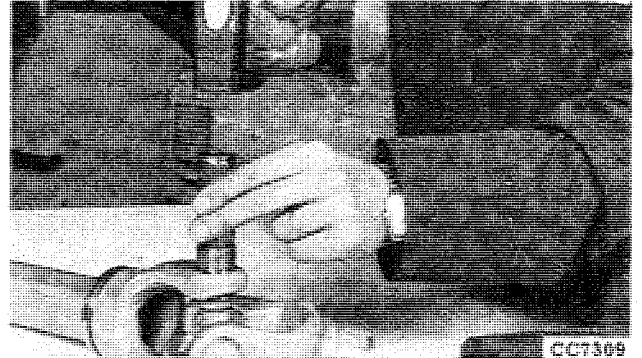

CC7309

CC7309-CCL15005AE-200885

Remove Snap Ring

Remove snap ring with snap ring pliers.

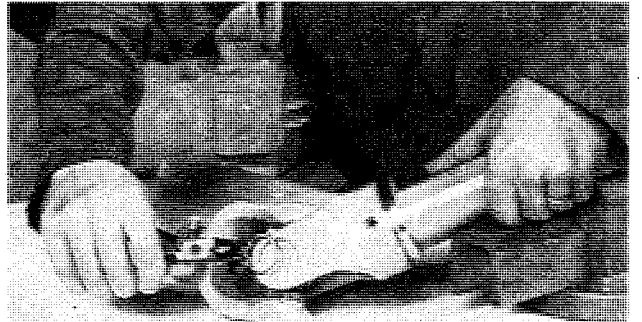

CC7310

CC7310-CCL15005AE-200885

Remove Bearing

Remove the first bearing from the ear.



CC7311

CC7311-CCL15005AE-200885

Remove First Bearing

Complete removal of first bearing.



CC7312-CCL15005AE-200885

Remove Snap Ring

After removing snap ring, remove the second bearing.

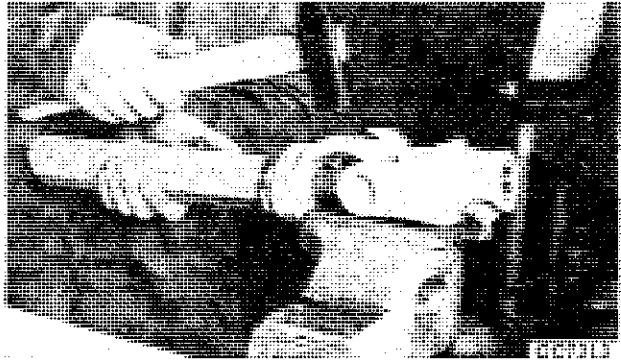

CC7313-CCL15005AE-200885

Remove Second Bearing

Remove bearings of outer yoke.



CC7314-CCL15005AE-200885

PTO HOOKUP REASSEMBLY

Grease the inside of the bearings to hold the needles in place.



CC7315

CC7315-CCL15005AE-200885



Suggest:

If the above button click is invalid.

Please download this document

first, and then click the above link

to download the complete manual.

Thank you so much for reading

Install First Bearing

Push first bearing in the ear. Hold the needles in place using the journal arm.

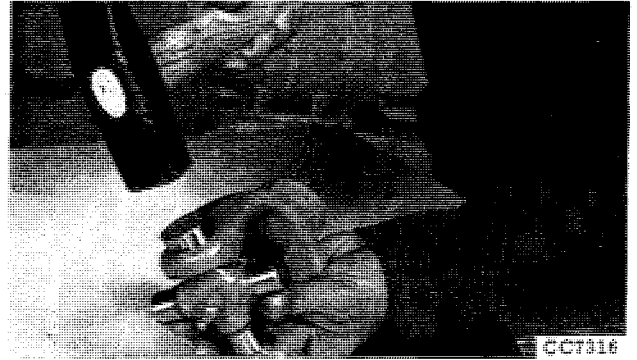

CC7316-CCL15005AE-200885

Install Second Bearing

Repeat the whole process for the second bearing. Adjust bearing position and insert both snap rings.

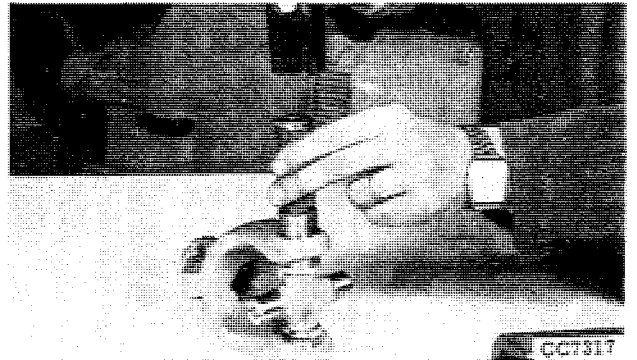

CC7317-CCL15005AE-200885

Install Inner Yoke Bearing

Install inner yoke bearings. Make sure that the grease fitting faces the inner yoke.

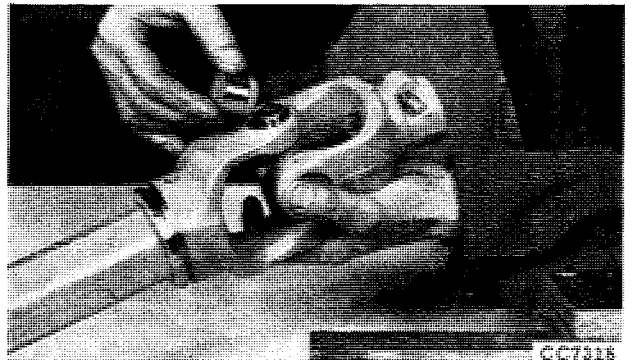

CC7318-CCL15005AE-200885

Adjust Bearing Position

Adjust the position of the bearings and insert both snap rings. Tap the ear base lightly to fully seat the snap rings and loosen the joint.



CC7319-CCL15005AE-200885

<https://www.ebooklibonline.com>

Hello dear friend!

Thank you very much for reading.

Enter the link into your browser.

The full manual is available for immediate download.

<https://www.ebooklibonline.com>