

# **820**

# **Mower-Conditioner**

**John Deere Ottumwa Works**  
**TM1547 (19FEB01)**

LITHO IN U.S.A.  
ENGLISH

# Introduction

## FOREWORD

This manual is written for an experienced technician. Essential tools required in performing certain service work are identified in this manual and are recommended for use.

Live with safety: Read the safety messages in the introduction of this manual and the cautions presented throughout the text of the manual.



This is the safety-alert symbol. When you see this symbol on the machine or in this manual, be alert to the potential for personal injury.

The technical manual contains two types of information: diagnostics and repair. Diagnostic groups help you identify the majority of routine failures quickly. Repair groups tell how to repair the components.

Information is organized in groups for the various components requiring service instruction. At the beginning of each group are summary listings of all applicable essential tools, service equipment and tools, other materials needed to do the job, service parts kits, specifications, wear tolerances, and torque values.

Binders, binder labels, and tab sets can be ordered by John Deere dealers direct from the John Deere Distribution Service Center.

This manual is part of a total product support program.

## FOS MANUALS—REFERENCE

### TECHNICAL MANUALS—MACHINE SERVICE

### COMPONENT MANUALS—COMPONENT SERVICE

Fundamentals of Service (FOS) Manuals cover basic theory of operation, fundamentals of troubleshooting, general maintenance, and basic type of failures and their causes. FOS Manuals are for training new personnel and for reference by experienced technicians.

Technical Manuals are concise guides for specific machines. Technical manuals are on-the-job guides containing only the vital information needed for diagnosis, analysis, testing, and repair.

Component Technical Manuals are concise service guides for specific components. Component technical manuals are written as stand-alone manuals covering multiple machine applications.

# Dealer Presentation Sheet

## JOHN DEERE DEALERS

**IMPORTANT: Please remove this page and route through your service department.**

This is a complete revision for TM1547, 820 Mower-Conditioners.

Listed below is a brief explanation of “WHAT” was changed and “WHY” it was changed.

This manual was revised to correct and update:

**Section 20** —For miscellaneous art and text changes throughout this section with the following major changes:

- Group 20:
  - Procedure for replacing Power-Cushion drive shaft has been expanded to include additional information for installing rear bearing jam nut.
- Group 25:
  - Procedures to remove and install slip clutch has been revised to include changes for machines (Serial No. 986001— ).

**Section 30** —For miscellaneous art and text changes throughout this section with the following major changes:

- Group 15:
  - New procedures to install guards and adjust hold-downs for machines (Serial No. 986001— ) have been added.

**Section 50** —For miscellaneous art and text changes throughout this section with the following major changes:

- Group 15:
  - New procedure to remove and install left roll arm for machines (Serial No. 986001— ) has been added.
  - New procedure to replace idler gear bearings and seals for machines (Serial No. 986001— ) has been added.
- Group 20:
  - New procedures to remove and install upper and lower rolls for machines (Serial No. 986001— ).
  - New procedure to adjust roll alignment for machines (Serial No. 986001— ) has been added.
  - To revise procedure for adjusting roll pressure.

**Section 60** —For miscellaneous art and text changes throughout this section with the following major changes:

- Group 15:
  - New procedure to adjust windrow width for machines (Serial No. 986001— ) has been added.

**Section 70** —For miscellaneous art and text changes throughout this section with the following major changes:

- Group 20 (new):
  - Procedures to repair the optional hydraulic center link used on machines (Serial No. 986001— ) have been added.

**<https://www.ebooklibonline.com>**

Hello dear friend!

Thank you very much for reading.

Enter the link into your browser.

The full manual is available for immediate download.

**<https://www.ebooklibonline.com>**

# Contents

## SECTION 10—GENERAL

- Group 05—Safety
- Group 10—Specifications
- Group 15—General Information
- Group 20—Lubrication

- Group 10—Diagnosing Malfunctions
- Group 15—Hydraulic Lift Cylinders
- Group 20—Hydraulic Center Link

## SECTION 20—POWER TRAIN

- Group 05—General Information
- Group 10—Diagnosing Malfunctions
- Group 15—PTO Hookup
- Group 20—Driveline
- Group 25—Slip Clutch
- Group 30—Main Drive Gear Case
- Group 35—Cutterbar Drive Gear Case
- Group 40—Miscellaneous Drive Components

## SECTION 80—TOOLS

- Group 05—Special Tools
- Group 10—Fabricated Tools

## Index

## SECTION 30—CUTTING COMPONENTS

- Group 05—General Information
- Group 10—Diagnosing Malfunctions
- Group 15—Cutterbar

## SECTION 40—PLATFORM

- Group 05—General Information
- Group 10—Diagnosing Malfunctions
- Group 15—Platform
- Group 20—Reel

## SECTION 50—CONDITIONER

- Group 05—General Information
- Group 10—Diagnosing Malfunctions
- Group 15—Roll Arms and Bearings
- Group 20—Rolls

## SECTION 60—CARRIER FRAME

- Group 05—General Information
- Group 10—Diagnosing Malfunctions
- Group 15—Carrier Frame and Components
- Group 20—Tongue
- Group 25—Wheel Hub and Support
- Group 30—Electrical

## SECTION 70—HYDRAULICS

- Group 05—General Information

*All information, illustrations and specifications in this manual are based on the latest information available at the time of publication. The right is reserved to make changes at any time without notice.*

TM1547-19-19FEB01

COPYRIGHT© 1995  
DEERE & COMPANY  
Moline, Illinois  
All rights reserved  
A John Deere ILLUSTRATION® Manual  
Previous Editions  
Copyright 1994 Deere & Company

# Section 10 GENERAL

10

## Contents

### Page

**Group 05—Safety** . . . . . 10-05-1

**Group 10—Specifications**

Machine Specifications . . . . . 10-10-1

Cap Screw Torque Values . . . . . 10-10-3

**Group 15—General Information**

Machine Description . . . . . 10-15-1

**Group 20—Lubrication**

Main Drive Gear Case Oil . . . . . 10-20-1

Cutterbar Drive Gear Case Oil . . . . . 10-20-1

Grease . . . . . 10-20-2

## HANDLE FLUIDS SAFELY—AVOID FIRES

When you work around fuel, do not smoke or work near heaters or other fire hazards.

Store flammable fluids away from fire hazards. Do not incinerate or puncture pressurized containers.

Make sure machine is clean of trash, grease, and debris.

Do not store oily rags; they can ignite and burn spontaneously.



DX,FLAME -19-04JUN90

10  
05  
-JUN-23AUG88  
TS227

## PREPARE FOR EMERGENCIES

Be prepared if a fire starts.

Keep a first aid kit and fire extinguisher handy.

Keep emergency numbers for doctors, ambulance service, hospital, and fire department near your telephone.

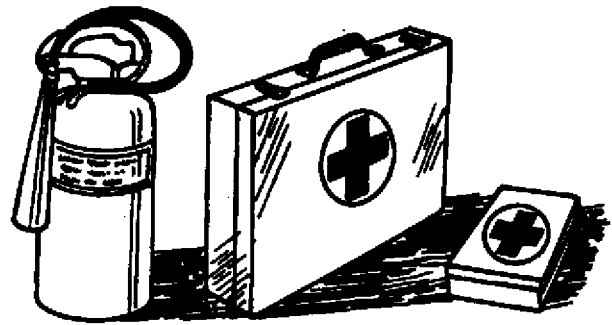

DX,FIRE2 -19-03MAR93

-JUN-23AUG88  
TS291

## HANDLE CHEMICAL PRODUCTS SAFELY

Direct exposure to hazardous chemicals can cause serious injury. Potentially hazardous chemicals used with John Deere equipment include such items as lubricants, coolants, paints, and adhesives.

A Material Safety Data Sheet (MSDS) provides specific details on chemical products: physical and health hazards, safety procedures, and emergency response techniques.

Check the MSDS before you start any job using a hazardous chemical. That way you will know exactly what the risks are and how to do the job safely. Then follow procedures and recommended equipment.

(See your John Deere dealer for MSDS's on chemical products used with John Deere equipment.)

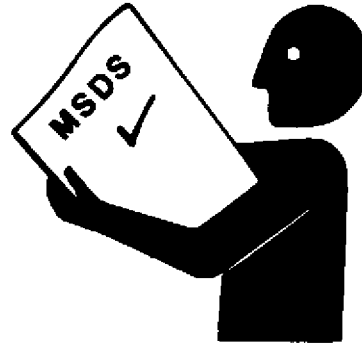

DX.MSDS,NA -19-03MAR93

TS1132 -JUN-26NOV90

## AVOID HIGH-PRESSURE FLUIDS

Escaping fluid under pressure can penetrate the skin causing serious injury.

Avoid the hazard by relieving pressure before disconnecting hydraulic or other lines. Tighten all connections before applying pressure.

Search for leaks with a piece of cardboard. Protect hands and body from high pressure fluids.

If an accident occurs, see a doctor immediately. Any fluid injected into the skin must be surgically removed within a few hours or gangrene may result. Doctors unfamiliar with this type of injury should reference a knowledgeable medical source. Such information is available from Deere & Company Medical Department in Moline, Illinois, U.S.A.

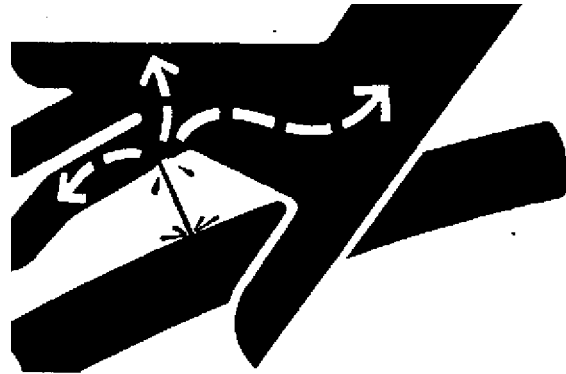

DX,FLUID -19-03MAR93

X9811 -JUN-23AUG88

## SUPPORT MACHINE PROPERLY

Always lower the attachment or implement to the ground before you work on the machine. If you must work on a lifted machine or attachment, securely support the machine or attachment.

Do not support the machine on cinder blocks, hollow tiles, or props that may crumble under continuous load. Do not work under a machine that is supported solely by a jack. Follow recommended procedures in this manual.

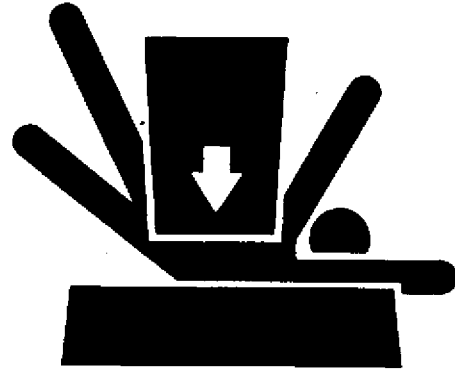

DX,LOWER -19-04JUN90

10  
3  
5  
-JUN-23AUG88  
TS229

## WEAR PROTECTIVE CLOTHING

Wear close fitting clothing and safety equipment appropriate to the job.

Prolonged exposure to loud noise can cause impairment or loss of hearing.

Wear a suitable hearing protective device such as earmuffs or earplugs to protect against objectionable or uncomfortable loud noises.

Operating equipment safely requires the full attention of the operator. Do not wear radio or music headphones while operating machine.

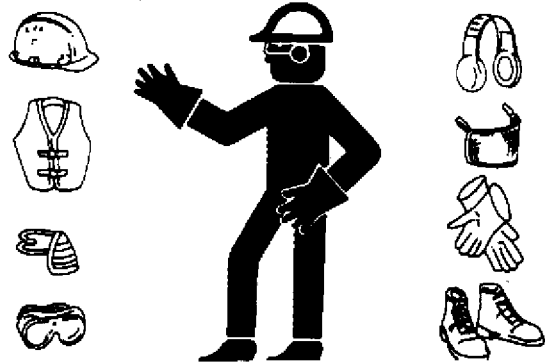

DX,WEAR -19-10SEP90

-JUN-23AUG88  
TS206

## STAY CLEAR OF ROTATING DRIVELINES

Entanglement in rotating driveline can cause serious injury or death.

Keep tractor master shield and driveline shields in place at all times. Make sure rotating shields turn freely.

Wear close fitting clothing. Stop the engine and be sure PTO driveline is stopped before making adjustments, connections, or cleaning out PTO driven equipment.



DX,PTO -19-12SEP95

-JUN-22AUG95  
TS1644

10  
05  
4

### WORK IN CLEAN AREA

Before starting a job:

- Clean work area and machine.
- Make sure you have all necessary tools to do your job.
- Have the right parts on hand.
- Read all instructions thoroughly; do not attempt shortcuts.

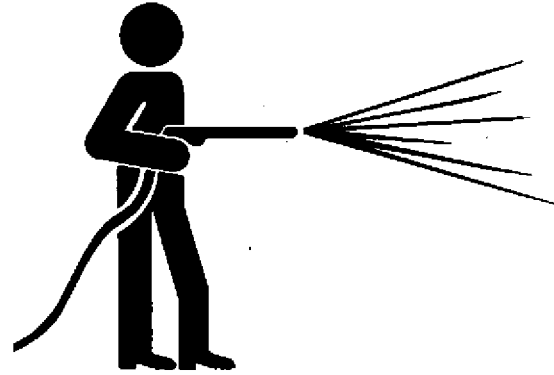

DX,CLEAN -19-04JUN90

T6642EJ -JUN-18OCT88

### SERVICE MACHINES SAFELY

Tie long hair behind your head. Do not wear a necktie, scarf, loose clothing, or necklace when you work near machine tools or moving parts. If these items were to get caught, severe injury could result.

Remove rings and other jewelry to prevent electrical shorts and entanglement in moving parts.

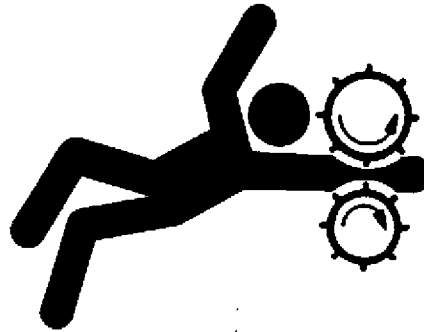

DX,LOOSE -19-04JUN90

TS228 -JUN-23AUG88

### WORK IN VENTILATED AREA

Engine exhaust fumes can cause sickness or death. If it is necessary to run an engine in an enclosed area, remove the exhaust fumes from the area with an exhaust pipe extension.

If you do not have an exhaust pipe extension, open the doors and get outside air into the area.

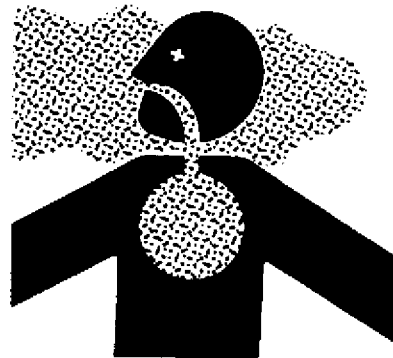

DX,AIR -19-04JUN90

TS220 -JUN-23AUG88

### ILLUMINATE WORK AREA SAFELY

Illuminate your work area adequately but safely. Use a portable safety light for working inside or under the machine. Make sure the bulb is enclosed by a wire cage. The hot filament of an accidentally broken bulb can ignite spilled fuel or oil.



DX,LIGHT -19-04JUN90

TS223 -JUN-23AUG88

## REPLACE SAFETY SIGNS

Replace missing or damaged safety signs. See the machine operator's manual for correct safety sign placement.

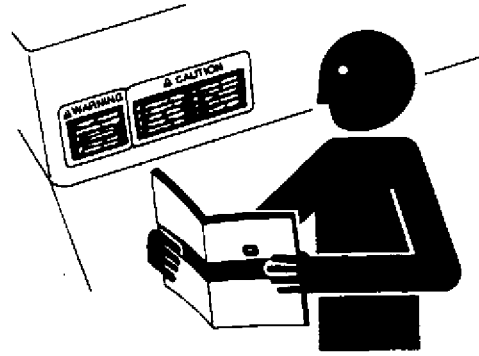

DX,SIGNS1 -19-04JUN90

TS201 -JUN-23AUG88

51510

## USE PROPER LIFTING EQUIPMENT

Lifting heavy components incorrectly can cause severe injury or machine damage.

Follow recommended procedure for removal and installation of components in the manual.

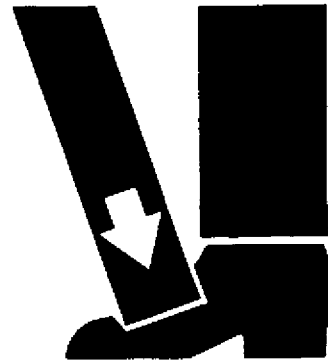

DX,LIFT -19-04JUN90

TS226 -JUN-23AUG88

## REMOVE PAINT BEFORE WELDING OR HEATING

Avoid potentially toxic fumes and dust.

Hazardous fumes can be generated when paint is heated by welding, soldering, or using a torch.

Do all work outside or in a well ventilated area. Dispose of paint and solvent properly.

Remove paint before welding or heating:

- If you sand or grind paint, avoid breathing the dust. Wear an approved respirator.
- If you use solvent or paint stripper, remove stripper with soap and water before welding. Remove solvent or paint stripper containers and other flammable material from area. Allow fumes to disperse at least 15 minutes before welding or heating.

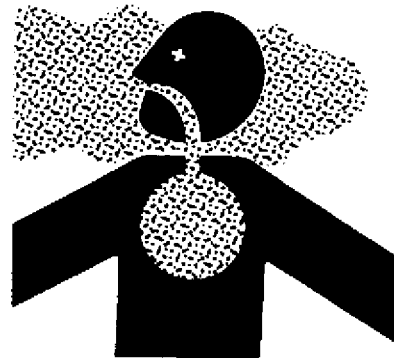

DX,PAINT -19-03MAR93

TS220 -JUN-23AUG88

10-05-6

### AVOID HEATING NEAR PRESSURIZED FLUID LINES

Flammable spray can be generated by heating near pressurized fluid lines, resulting in severe burns to yourself and bystanders. Do not heat by welding, soldering, or using a torch near pressurized fluid lines or other flammable materials. Pressurized lines can be accidentally cut when heat goes beyond the immediate flame area.



DX,TORCH -19-03MAR93

TS953 -JUN-15MAY90

### SERVICE TIRES SAFELY

Explosive separation of a tire and rim parts can cause serious injury or death.

Do not attempt to mount a tire unless you have the proper equipment and experience to perform the job.

Always maintain the correct tire pressure. Do not inflate the tires above the recommended pressure. Never weld or heat a wheel and tire assembly. The heat can cause an increase in air pressure resulting in a tire explosion. Welding can structurally weaken or deform the wheel.

When inflating tires, use a clip-on chuck and extension hose long enough to allow you to stand to one side and NOT in front of or over the tire assembly. Use a safety cage if available.

Check wheels for low pressure, cuts, bubbles, damaged rims or missing lug bolts and nuts.

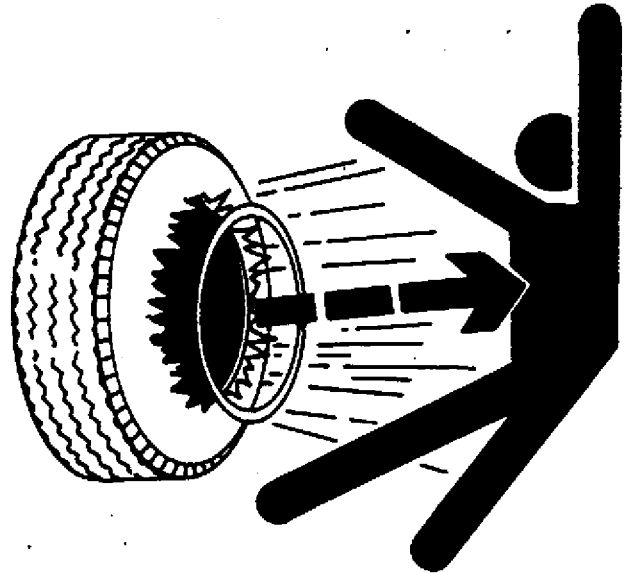

DX,RIM -19-24AUG90

-JUN-23AUG88

TS211

## PRACTICE SAFE MAINTENANCE

Understand service procedure before doing work. Keep area clean and dry.

Never lubricate, service, or adjust machine while it is moving. Keep hands, feet, and clothing from power-driven parts. Disengage all power and operate controls to relieve pressure. Lower equipment to the ground. Stop the engine. Remove the key. Allow machine to cool.

Securely support any machine elements that must be raised for service work.

Keep all parts in good condition and properly installed. Fix damage immediately. Replace worn or broken parts. Remove any buildup of grease, oil, or debris.

Disconnect battery ground cable (-) before making adjustments on electrical systems or welding on machine.



-JUN-23AUG88

TS218

DX,SERV -19-03MAR93

## USE PROPER TOOLS

Use tools appropriate to the work. Makeshift tools and procedures can create safety hazards.

Use power tools only to loosen threaded parts and fasteners.

For loosening and tightening hardware, use the correct size tools. DO NOT use U.S. measurement tools on metric fasteners. Avoid bodily injury caused by slipping wrenches.

Use only service parts meeting John Deere specifications.



-JUN-08NOV89

TS779

DX,REPAIR -19-04JUN90

10  
05  
8

### DISPOSE OF WASTE PROPERLY

Improperly disposing of waste can threaten the environment and ecology. Potentially harmful waste used with John Deere equipment include such items as oil, fuel, coolant, brake fluid, filters, and batteries.

Use leakproof containers when draining fluids. Do not use food or beverage containers that may mislead someone into drinking from them.

Do not pour waste onto the ground, down a drain, or into any water source.

Air conditioning refrigerants escaping into the air can damage the Earth's atmosphere. Government regulations may require a certified air conditioning service center to recover and recycle used air conditioning refrigerants.

Inquire on the proper way to recycle or dispose of waste from your local environmental or recycling center, or from your John Deere dealer.

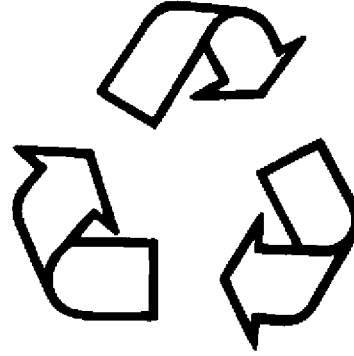

TS1133 -JUN-26NOV90

DX,DRAIN -19-03MAR93

### LIVE WITH SAFETY

Before returning machine to customer, make sure machine is functioning properly, especially the safety systems. Install all guards and shields.



TS231 -19-07OCT88

DX,LIVE -19-25SEP92





**METRIC BOLT AND CAP SCREW TORQUE VALUES**

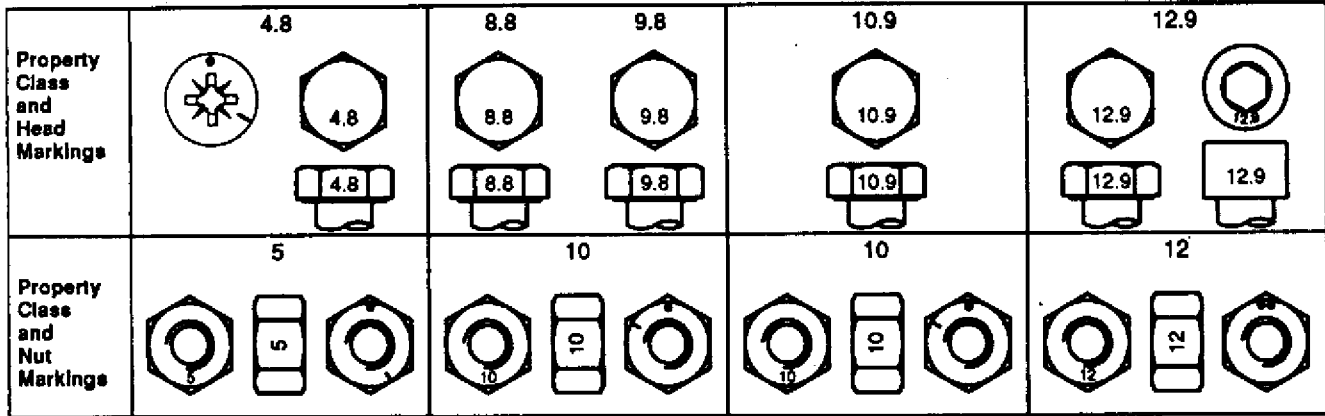

Size	Class 4.8				Class 8.8 or 9.8				Class 10.9				Class 12.9			
	Lubricated <sup>a</sup>		Dry <sup>a</sup>		Lubricated <sup>a</sup>		Dry <sup>a</sup>		Lubricated <sup>a</sup>		Dry <sup>a</sup>		Lubricated <sup>a</sup>		Dry <sup>a</sup>	
	N·m	lb-ft	N·m	lb-ft	N·m	lb-ft	N·m	lb-ft	N·m	lb-ft	N·m	lb-ft	N·m	lb-ft	N·m	lb-ft
M6	4.8	3.5	6	4.5	9	6.5	11	8.5	13	9.5	17	12	15	11.5	19	14.5
M8	12	8.5	15	11	22	16	28	20	32	24	40	30	37	28	47	35
M10	23	17	29	21	43	32	55	40	63	47	80	60	75	55	95	70
M12	40	29	50	37	75	55	95	70	110	80	140	105	130	95	165	120
M14	63	47	80	60	120	88	150	110	175	130	225	165	205	150	260	190
M16	100	73	125	92	190	140	240	175	275	200	350	255	320	240	400	300
M18	135	100	175	125	260	195	330	250	375	275	475	350	440	325	560	410
M20	190	140	240	180	375	275	475	350	530	400	675	500	625	460	800	580
M22	260	190	330	250	510	375	650	475	725	540	925	675	850	625	1075	800
M24	330	250	425	310	650	475	825	600	925	675	1150	850	1075	800	1350	1000
M27	490	360	625	450	950	700	1200	875	1350	1000	1700	1250	1600	1150	2000	1500
M30	675	490	850	625	1300	950	1650	1200	1850	1350	2300	1700	2150	1600	2700	2000
M33	900	675	1150	850	1750	1300	2200	1650	2500	1850	3150	2350	2900	2150	3700	2750
M36	1150	850	1450	1075	2250	1650	2850	2100	3200	2350	4050	3000	3750	2750	4750	3500

DO NOT use these values if a different torque value or tightening procedure is given for a specific application. Torque values listed are for general use only. Check tightness of fasteners periodically.

Shear bolts are designed to fail under predetermined loads. Always replace shear bolts with identical property class.

Fasteners should be replaced with the same or higher property class. If higher property class fasteners are used, these should only be tightened to the strength of the original.

<sup>a</sup> "Lubricated" means coated with a lubricant such as engine oil, or fasteners with phosphate and oil coatings. "Dry" means plain or zinc plated without any lubrication.

Make sure fasteners threads are clean and that you properly start thread engagement. This will prevent them from failing when tightening.

Tighten plastic insert or crimped steel-type lock nuts to approximately 50 percent of the dry torque shown in the chart, applied to the nut, not to the bolt head. Tighten toothed or serrated-type lock nuts to the full torque value.

10  
10  
3  
TS1163 -19-04VARR91

UNIFIED INCH BOLT AND CAP SCREW TORQUE VALUES

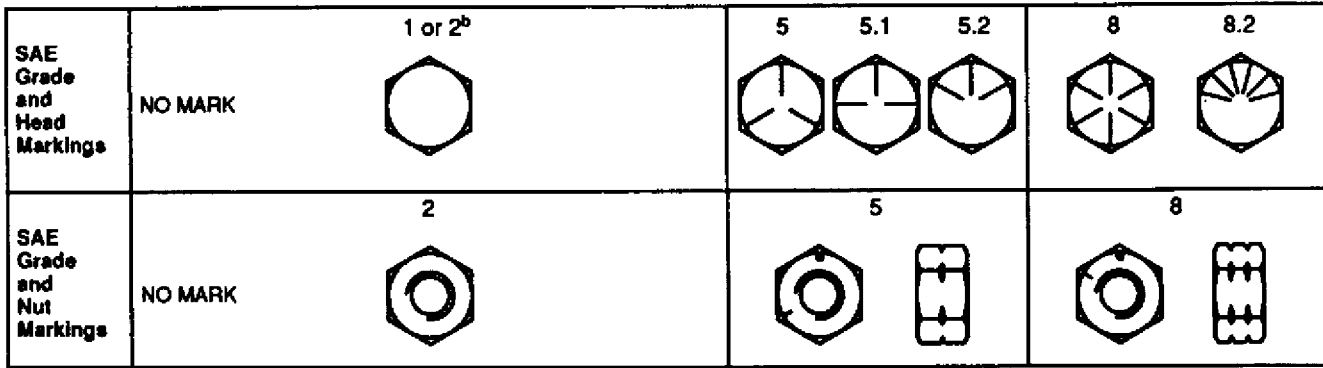

Size	Grade 1				Grade 2 <sup>b</sup>				Grade 5, 5.1, or 5.2				Grade 8 or 8.2			
	Lubricated <sup>a</sup>		Dry <sup>a</sup>		Lubricated <sup>a</sup>		Dry <sup>a</sup>		Lubricated <sup>a</sup>		Dry <sup>a</sup>		Lubricated <sup>a</sup>		Dry <sup>a</sup>	
	N·m	lb-ft	N·m	lb-ft	N·m	lb-ft	N·m	lb-ft	N·m	lb-ft	N·m	lb-ft	N·m	lb-ft	N·m	lb-ft
1/4	3.7	2.8	4.7	3.5	6	4.5	7.5	5.5	9.5	7	12	9	13.5	10	17	12.5
5/16	7.7	5.5	10	7	12	9	15	11	20	15	25	18	28	21	35	26
3/8	14	10	17	13	22	16	27	20	35	26	44	33	50	36	63	46
7/16	22	16	28	20	35	26	44	32	55	41	70	52	80	58	100	75
1/2	33	25	42	31	53	39	67	50	85	63	110	80	120	90	150	115
9/16	48	36	60	45	75	56	95	70	125	90	155	115	175	130	225	160
5/8	67	50	85	62	105	78	135	100	170	125	215	160	240	175	300	225
3/4	120	87	150	110	190	140	240	175	300	225	375	280	425	310	550	400
7/8	190	140	240	175	190	140	240	175	490	360	625	450	700	500	875	650
1	290	210	360	270	290	210	360	270	725	540	925	675	1050	750	1300	975
1-1/8	400	300	510	375	400	300	510	375	900	675	1150	850	1450	1075	1850	1350
1-1/4	570	425	725	530	570	425	725	530	1300	950	1650	1200	2050	1500	2600	1950
1-3/8	750	550	950	700	750	550	950	700	1700	1250	2150	1550	2700	2000	3400	2550
1-1/2	1000	725	1250	925	990	725	1250	930	2250	1650	2850	2100	3600	2650	4550	3350

DO NOT use these values if a different torque value or tightening procedure is given for a specific application. Torque values listed are for general use only. Check tightness of fasteners periodically.

Shear bolts are designed to fail under predetermined loads. Always replace shear bolts with identical grade.

<sup>a</sup> "Lubricated" means coated with a lubricant such as engine oil, or fasteners with phosphate and oil coatings. "Dry" means plain or zinc plated without any lubrication.

<sup>b</sup> Grade 2 applies for hex cap screws (not hex bolts) up to 152 mm (6-in.) long. Grade 1 applies for hex cap screws over 152 mm (6-in.) long, and for all other types of bolts and screws of any length.

Fasteners should be replaced with the same or higher grade. If higher grade fasteners are used, these should only be tightened to the strength of the original.

Make sure fasteners threads are clean and that you properly start thread engagement. This will prevent them from failing when tightening.

Tighten plastic insert or crimped steel-type lock nuts to approximately 50 percent of the dry torque shown in the chart, applied to the nut, not to the bolt head. Tighten toothed or serrated-type lock nuts to the full torque value.

## MACHINE DESCRIPTION

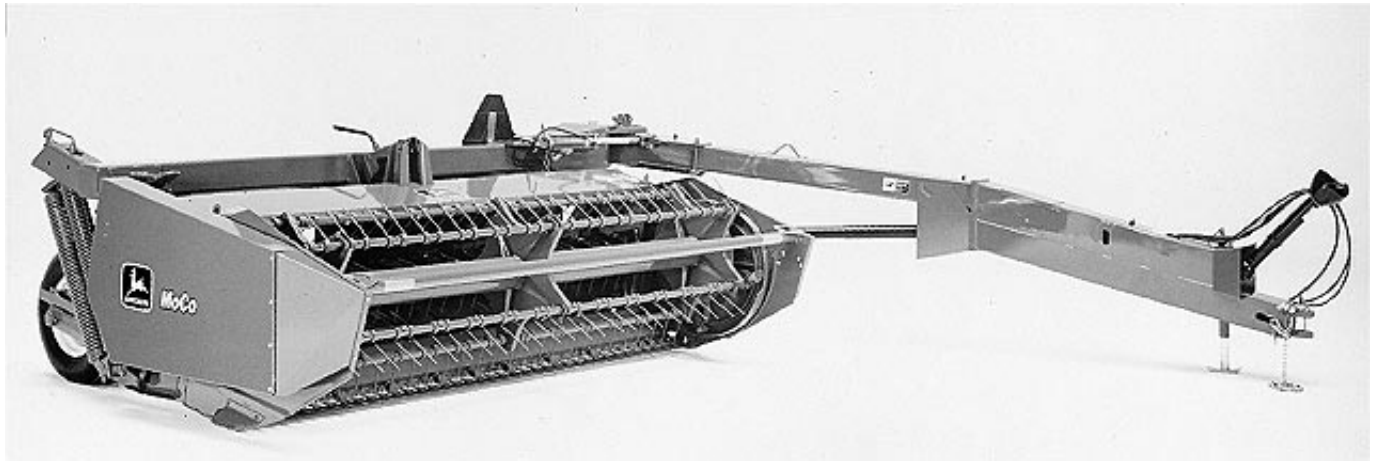

10  
15  
1  
-JUN-01JAN94  
E37360

The John Deere 820 mower-conditioner is a side pull design utilizing a mechanical PTO driveline. The machine comes equipped with a reciprocating (sickle) type cutterbar, a reel consisting of five tooth bars, and a roll type conditioner.

The machine consists of the following major assemblies:

- Carrier Frame
- Platform
- Tongue Assembly
- Wheel Assemblies
- Windrow Forming Shields

The carrier frame consists of a heavy steel tube that runs the full width of the machine. The carrier frame supports all the other major assemblies.

The platform contains the cutterbar, reel, conditioner, and related drive components. The platform connects to the carrier frame through a three-point suspension system.

The platform is raised and lowered using two hydraulic lift cylinders which are controlled by tractor hydraulics.

The tongue is made up of two sections, each constructed of heavy steel tubing. The tongue houses the PTO driveline and attaches to the left side of the carrier frame. The tongue can pivot relative to the carrier frame to allow the machine to be transported more easily.

The wheel support assemblies utilize hydraulic lift cylinders, controlled by tractor hydraulics, to raise and lower the platform and machine. The wheel supports pivot off the carrier frame and attach indirectly to the platform via the lift arms.

The windrow forming shields consist of separate panels bolted together to funnel the freshly cut and conditioned crop into a windrow. The forming shields connect directly to the carrier frame and use an adjustable panel for controlling windrow width.

EX,1547,1015,A -19-14DEC95

# Section 20 POWER TRAIN

## Contents

	Page	Page
<b>Group 05—General Information</b>		
Power Train Operation . . . . .	20-05-1	
Specifications . . . . .	20-05-2	
Torque Values . . . . .	20-05-3	
<b>Group 10—Diagnosing Malfunctions . . .</b>		
	20-10-1	
<b>Group 15—PTO Hookup</b>		
General Information . . . . .	20-15-1	
Repair . . . . .	20-15-1	
<b>Group 20—Driveline</b>		
Replace Power-Cushion Drive Shaft and Bearings . . . . .	20-20-1	
Repair Rear Driveline . . . . .	20-20-3	
<b>Group 25—Slip Clutch</b>		
Replace Lining . . . . .	20-25-1	
Remove . . . . .	20-25-3	
Disassemble . . . . .	20-25-5	
Inspect Parts . . . . .	20-25-7	
Assemble . . . . .	20-25-8	
Install . . . . .	20-25-11	
Adjust . . . . .	20-25-15	
Check For Proper Operation . . . . .	20-25-16	
<b>Group 30—Main Drive Gear Case</b>		
Remove and Install . . . . .	20-30-1	
Disassemble . . . . .	20-30-2	
Inspect Parts . . . . .	20-30-4	
Assemble . . . . .	20-30-5	
<b>Group 35—Cutterbar Drive Gear Case</b>		
Remove and Install . . . . .	20-35-1	
Disassemble . . . . .	20-35-2	
Inspect Parts . . . . .	20-35-5	
Assemble . . . . .	20-35-6	
<b>Group 40—Miscellaneous Drive Components</b>		
Cutterbar Drive Belt		
Replace . . . . .	20-40-1	
Adjust . . . . .	20-40-3	
Reel Drive Belt		
Replace . . . . .	20-40-4	
Adjust . . . . .	20-40-4	
Reel Drive Idler Assembly		
Repair . . . . .	20-40-5	
Care of Chains . . . . .	20-40-8	
Reel Speed-Up Sprocket		
Install . . . . .	20-40-8	
Adjustable Sheave and Sprocket Assembly		
Repair . . . . .	20-40-11	
Reel Drive Chain		
Adjust . . . . .	20-40-12	

**POWER TRAIN OPERATION**

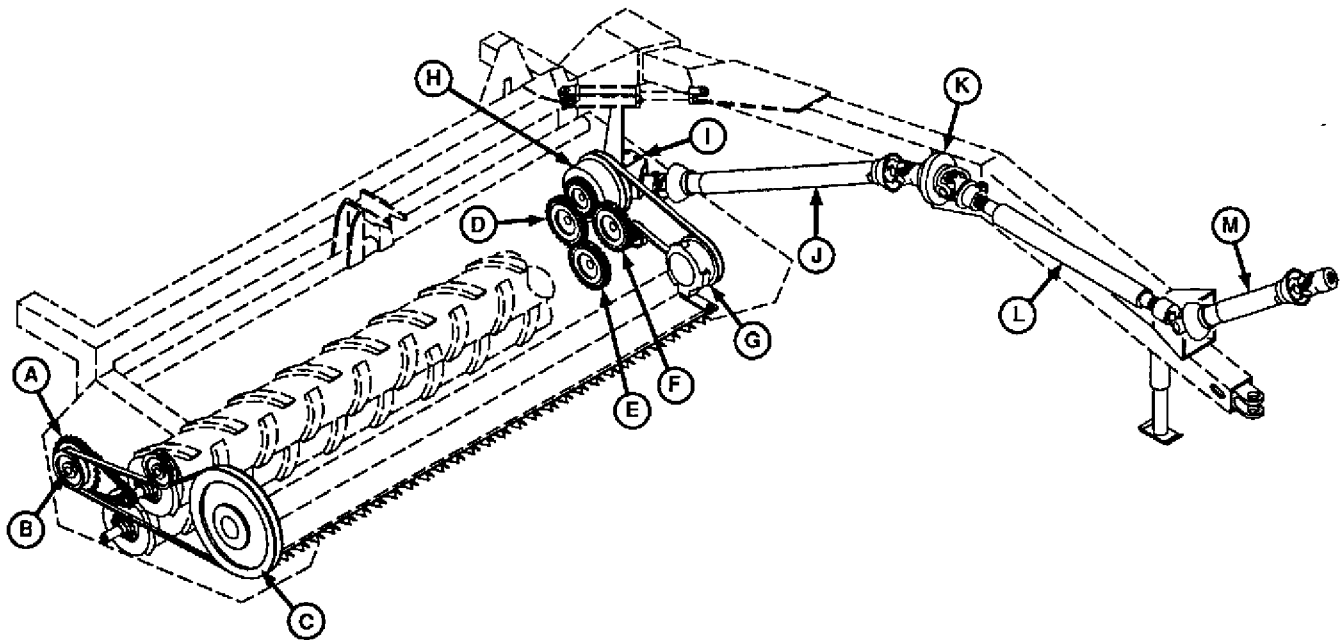

E37890 520 X 316

A—Sprocket and Chain  
B—Adjustable Sheave  
C—Reel Sheave  
D—Idler Gear

E—Lower Roll Drive Gear  
F—Upper Roll Drive Gear  
G—Cutterbar Drive Gear Case

H—Slip Clutch (with drive gear)  
I—Main Drive Gear Case  
J—Rear Drive Shaft

K—CV-Joint  
L—Power-Cushion  
M—PTO Hookup

The PTO driveline consists of a PTO hookup (M), a spring-loaded midshaft called the Power-Cushion (L) and a telescoping rear drive shaft (J). The rear drive shaft contains a CV-Joint (K) that compensates for the angle of the tongue.

Power from the tractor PTO is transferred through the PTO driveline to main drive gear case (I), and on to slip clutch (H). The slip clutch provides protection to the cutterbar and conditioner components.

From the slip clutch, power is transmitted to the rolls through external drive gears (D—F). A V-belt transmits the power to the cutterbar drive gear case (G).

The cutterbar drive gear case utilizes an eccentric shaft and yoke arrangement to transform power from a rotary motion to a reciprocating motion, causing the cutterbar knife to move back and forth. The gear

case is fully enclosed with the internal components lubricated with gear oil.

Power is transferred to the right side of platform through the upper conditioner roll. Power is then transmitted through a sprocket and chain arrangement (A). Attached to the driven sprocket is an adjustable sheave (B). From the adjustable sheave, a V-belt transfers power to reel sheave (C), which drives the reel.

Because sheave (B) is adjustable, reel speed can be varied. Adding shims between the sheave halves decreases the reel speed, while removing shims increases reel speed.

If reel speed needs to be increased beyond what the adjustable sheave can adjust to, an optional 16-tooth drive sprocket is available.

EX,1547,2005,A -19-14DEC95

**SPECIFICATIONS**

ITEM	MEASUREMENT	SPECIFICATION
Slip Clutch Spring	Length (inside of washer-to-clutch plate)	40 mm (1-9/16 in.)
Cutterbar Drive Belt Tension	Force	89—125 N (20—28 lb) pull, deflects belt 8 mm (5/16 in.)
Main Drive Gear Case:		
Output Shaft	Rolling Torque (spring scale and string method)	6—28 N (1.3—6.3 lb)
	Rolling Torque (torque wrench method)	0.1—0.5 N·m (0.9—4.3 lb-in.)
Input Shaft	Rolling Torque (spring scale and string method)	0.4—0.8 N·m (3.5—7.0 lb-in.)
	Rolling Torque (torque wrench method)	22—45 N (5.0—10.2 lb)
Gears	Backlash	0.15—0.40 mm (0.006—0.016 in.)
Cutterbar Drive Gear Case:		
Knife Drive Shaft	Rolling Torque (torque wrench method)	0.33—0.56 N·m (3—5 lb-in.)
Reel Drive Chain	Deflection	8—12 mm (5/16—1/2 in.)

EX,1547,2005,B -19-14DEC95

20  
05  
2



**Suggest:**

**If the above button click is invalid.**

**Please download this document**

**first, and then click the above link**

**to download the complete manual.**

**Thank you so much for reading**

## TORQUE VALUES

LOCATION	N-m	(lb-ft)
Power-Cushion:		
Jam Nut .....	407 .....	300
Slip Clutch:		
Socket Head Screw .....	170 .....	125
Main Drive Gear Case:		
Bracket-to-Frame Cap Screw .....	140 .....	105
Quill-to-Housing Cap Screw .....	79—106 .....	58—78
Cutterbar Drive Gear Case:		
Mounting Bracket Cap Screws .....	475 .....	350
Knife Head Clamp Bolt .....	217 .....	160
Cover Cap Screws .....	30—40 .....	22—29
Drive Arm-to-Yoke Nut .....	244 .....	180
Sheave Nut .....	136—162 .....	100—119
Reel Drive Sprocket Cap Screw .....	475 .....	350

EX,1547,2005.C -19-14DEC95

## OTHER MATERIAL

Number	Name	Use
PT569	NEVER-SEEZ®	Apply to slip clutch support shaft.
LOCTITE® PRODUCTS U.S./Canadian/LOCTITE No.		
T43512/TY9473/242	Thread Lock and Sealer (medium strength)	Apply to threads of Power-Cushion jam nut.
TY6304/TY9484/518	Flexible Gasket Sealant	Apply to cutterbar drive gear case quill.

NEVER-SEEZ is a trademark of the Emhart Chemical Group

LOCTITE is a trademark of the Loctite Corporation

EX,1547,2005.D -19-14DEC95

**<https://www.ebooklibonline.com>**

Hello dear friend!

Thank you very much for reading.

Enter the link into your browser.

The full manual is available for immediate download.

**<https://www.ebooklibonline.com>**