

**John Deere
690D Excavator
693D Feller-Buncher/
Delimber
Repair**



**TECHNICAL
MANUAL**

**John Deere Davenport Works
TM-1388 (Oct-87)**

Litho in U.S.A.

**690D EXCAVATOR
693D FELLER-BUNCHER/DELIMBER
TECHNICAL MANUAL
TM-1388 (SEP-87)**

SECTION AND GROUP CONTENTS

NOTE: This manual covers machine Repair (gray tabs).

SECTION I—GENERAL INFORMATION

- Group I—Introduction and Safety Information
- Group II—General Specifications
- Group III—Torque Values
- Group IV—Fuels and Lubricants
- Group V—Inspection Procedure

SECTION 01—TRACKS

- Group 0130—Track Systems
 - Track Roller, Track Chain, Sprocket, Front Idler, Recoil Spring, Relief Valve and Adjusting Cylinder

SECTION 02—AXLES AND SUSPENSION SYSTEMS (PROPEL)

- Group 0250—Axle Shafts, Bearings and Reduction Gears
 - Tow Excavator and Propel Gearbox
- Group 0260—Hydraulic Systems
 - Propel Motor, Propel Brake, Propel Brake Valve with Counterbalance Valve, Hydraulic Lines, and Rotary Manifold

SECTION 04—ENGINE

- 6414 Engine—See CTM-4
- Group 0400—Removal and Installation
 - Engine, Oil Pan, Fuel Injection Pump, Injection Nozzles, Bleed Fuel System, Turbocharger and Water Pump, Oil Cooler, Fuel Transfer Pump, and Thermostat

SECTION 05—ENGINE AUXILIARY SYSTEMS

- Group 0505—Cold Weather Starting Aids
 - Fluid Starting Aid Solenoid, Nozzle, Engine Coolant Heater
- Group 0510—Cooling Systems
 - Fan, Shroud and Guards, Fan Belt, Radiator
- Group 0515—Speed Controls
 - Speed Control Assembly (Auto Idle), Linkage
- Group 0520—Intake System
 - Air Cleaner, Air Intake System Leakage Test
- Group 0530—External Exhaust Systems
 - Muffler and Bracket
- Group 0560—External Fuel Supply Systems
 - Fuel Tank

SECTION 07—DAMPENER DRIVE (FLEX COUPLING)

- Group 0752—Elements

SECTION 16—ELECTRICAL SYSTEMS

- Group 1671—Batteries, Support and Cables
- Group 1672—Alternator, Regulator and Charging System Wiring
- Group 1673—Lighting System
- Group 1674—Wiring Harness and Switches
- Group 1677—Motors and Actuators
 - Starting Motor

SECTION 17—FRAME, CHASSIS, OR SUPPORTING STRUCTURE

- Group 1740—Frame Installation
 - Welding Repair
- Group 1749—Chassis Weights

All information, illustrations and specifications contained in this technical manual are based on the latest information available at the time of publication. The right is reserved to make changes at any time without notice.

COPYRIGHT® 1987
DEERE & COMPANY
Moline, Illinois
All rights reserved
A JOHN DEERE ILLUSTRATION

/1388 CC1 040987

SECTION AND GROUP CONTENTS—Continued

SECTION 18—OPERATOR'S STATION

- Group 1800—Removal and Installation
Cab or Canopy
- Group 1810—Operator Enclosure
Windowpanes, Cab Door and
Latch, Door Lock, Windshield
Wiper
- Group 1821—Seat
- Group 1830—Heating and Air Conditioning
Compressor, High Pressure
Switch, Condenser, Evaporator,
Expansion Valve, Receiver-Dryer,
Low Pressure Switch, Air
Conditioning Switches, Resistor,
Blower Motor, Heater, Controls

SECTION 99—DEALER FABRICATED TOOLS

SECTION 19—SHEET METAL AND STYLING

- Group 1910—Hood or Engine Enclosure

SECTION 33—EXCAVATOR

- Group 3302—Buckets
Bucket, Linkage, Bushings, Tooth
Tip, Tooth Shank
- Group 3340—Frames
Arm, Boom, Bushings
- Group 3360—Hydraulic System
Hydraulic Pump, Pilot System
Pump, Pilot System Pressure
Regulating Valve, Hydraulic
Control Valve, Relief Valve Block,
Hydraulic Control Valve Return
Restrictors, Reservoir, Return
Filter, Reservoir Relief Valve, Oil
Cooler Bypass Valve, Oil Cooler,
Cylinders, Propel Function Pilot
Controller Valve, Propel Pilot
System Check Valve Block, Dig
Function Pilot Controller Valve,
Pilot System Shut-off Valve, Pilot
System Filter, Flow Control Valve

SECTION 43—SWING, ROTATION OR PIVOTING SYSTEM

- Group 4311—Brakes (Swing Lock)
- Group 4350—Mechanical Drive Elements
Swing Gearbox, Swing Bearing,
Seals
- Group 4360—Hydraulic System
Swing Motor, Crossover Relief
Valves, Swing Lock Release Valves

/1388 CC2 040987

<https://www.ebooklibonline.com>

Hello dear friend!

Thank you very much for reading.

Enter the link into your browser.

The full manual is available for immediate download.

<https://www.ebooklibonline.com>

INTRODUCTION

This manual is part of a total service support program.

FOS Manuals—reference

Technical Manuals—machine service

Component Manuals—component service

Fundamentals of Service (FOS) Manuals cover basic theory of operation, fundamentals of troubleshooting, general maintenance, and basic types of failures and their causes. FOS Manuals are for training new personnel and for reference by experienced technicians.

Technical Manuals are concise service guides for specific machines. Technical manuals are on-the-job guides containing only the vital information needed by an experienced service technician.

Component Technical Manuals are concise service guides for specific components. Component technical manuals are written as stand alone manuals covering multiple machine applications.

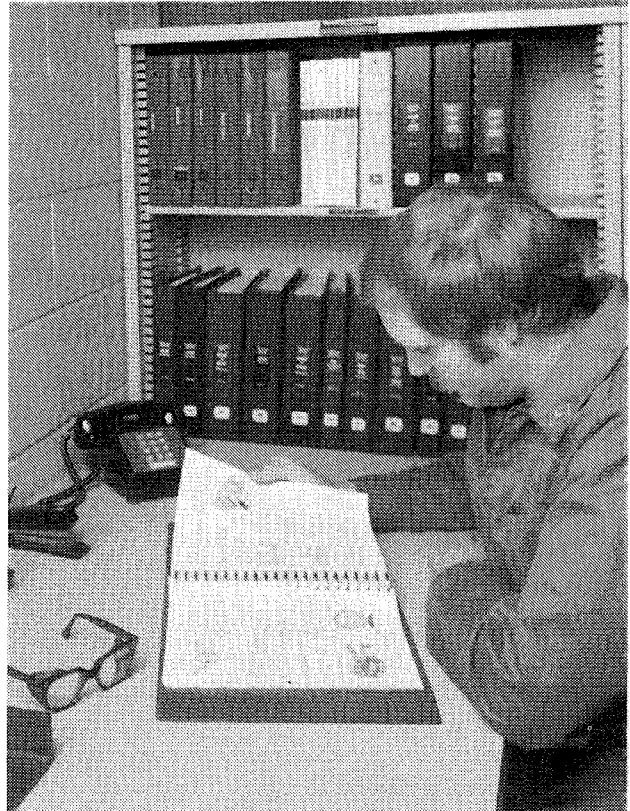

AB6;RW5559 053;INTRO2 030785

FEATURES OF THIS TECHNICAL MANUAL

John Deere ILLUSTRATION format emphasizing illustrations and concise instructions in easy-to-use modules.

Emphasis on diagnosis, analysis, and testing so you can understand the problem and correct it.

Diagnostic information presented with the most logical and easiest to isolate problems first to help you identify the majority of routine failures quickly.

Step-by-step instructions for teardown and assembly.

Summary listing at the beginning of each group of all applicable specifications, wear tolerances, torque values, essential tools, and materials needed to do the job.

An emphasis throughout on safety—so you do the job right without getting hurt.

This technical manual was planned and written for you—an experienced service technician. Keep it in a permanent binder in the shop where it is handy. Refer to it when you need to know correct service procedures or specifications.

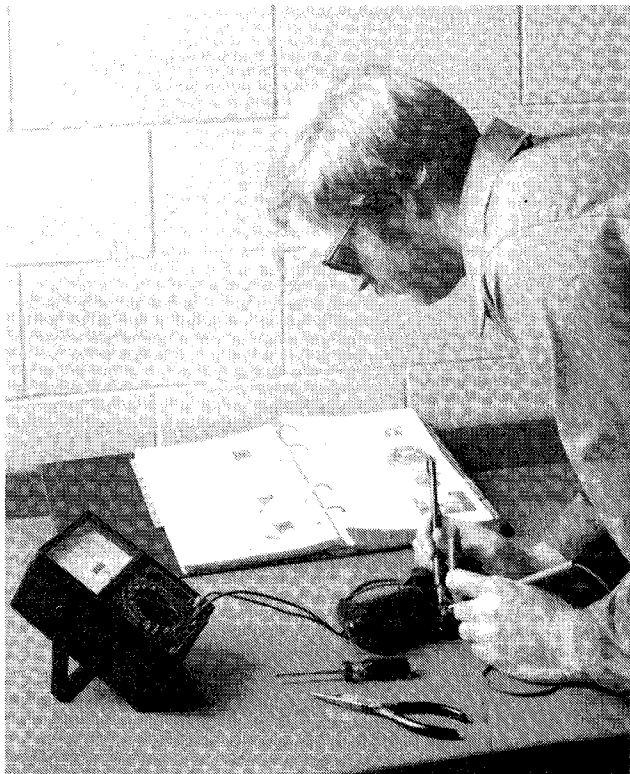

AB6;RW5560 053;INTRO3 071085

USING TABS

To fully utilize this technical manual, you must understand how it is organized.

Only two tab colors are used—gray and yellow. Each color represents a different type of information.

Spend a minute reading this now and save many minutes of searching later.

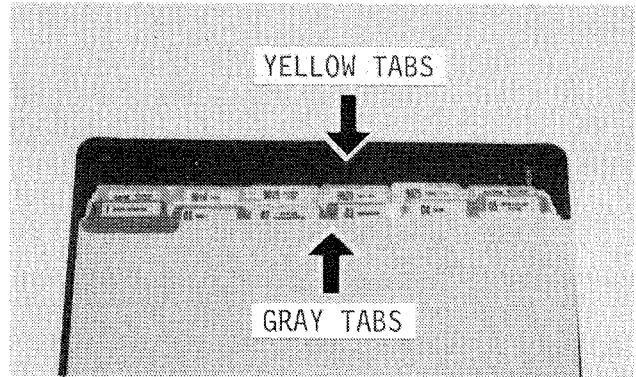

018;T5933AB T82;FLPD I 260785

GRAY TAB SECTIONS

The gray tab sections are repair sections that tell how to repair the components of the various systems.

Repair of a component includes:

- Removal from machine (when necessary)
- Disassembly
- Inspection
- Replacement of parts
- Assembly
- Adjustment
- Installation on machine (when necessary)

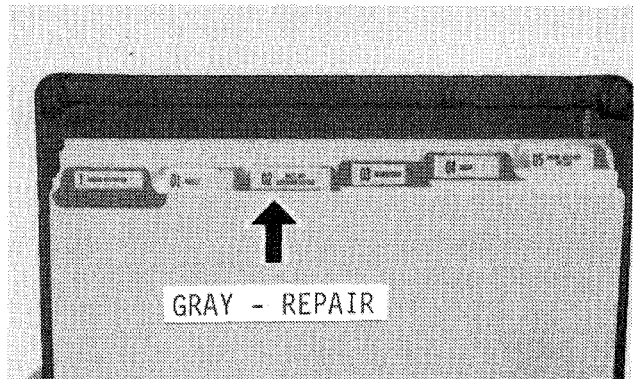

The numbers used for the repair (gray tab) sections are part of an overall service publication numbering system. The numbers identify the same sections in the parts catalog, flat rate manual, service information bulletins, and service training courses.

018;T5933AC T82;FLPD J 260785

YELLOW TAB SECTIONS

Each yellow tab section contains information on:

Groups	
05	Theory of Operation
10	System Operational Checks
15	System Diagnostic Information
20	Adjustments
25	Tests

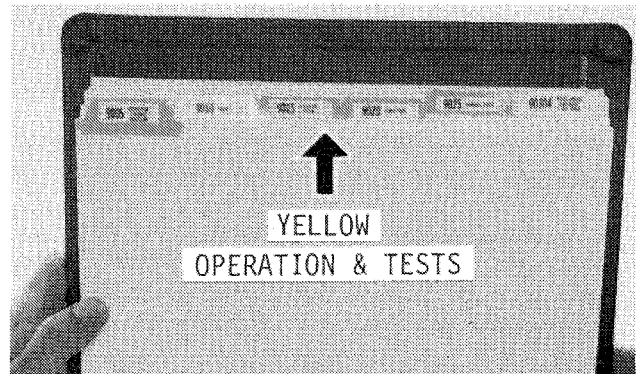

018;T5933AD T82;FLPD K 260785

THREE-STEP PROCEDURE

Use the following three-step procedure to locate the desired information.

1. Determine the type of information you need. Is it repair, operation, or tests?

2. Go to the appropriate section tab:

Gray for Repair

Yellow for Operation or Tests

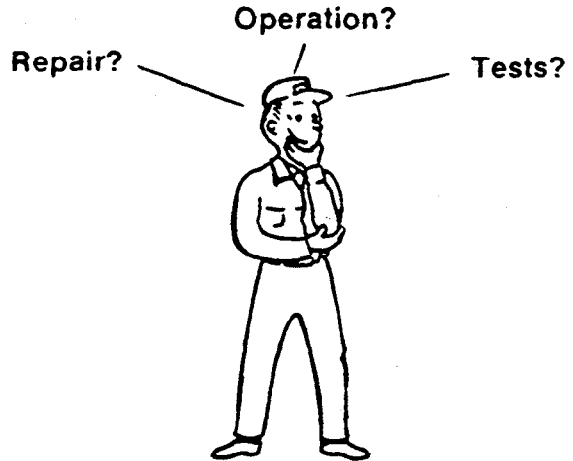

TYPE OF INFORMATION?

018;T5940AT T82;FLPD L 260785

3. Use the table of contents on the first page of the section to locate the information.

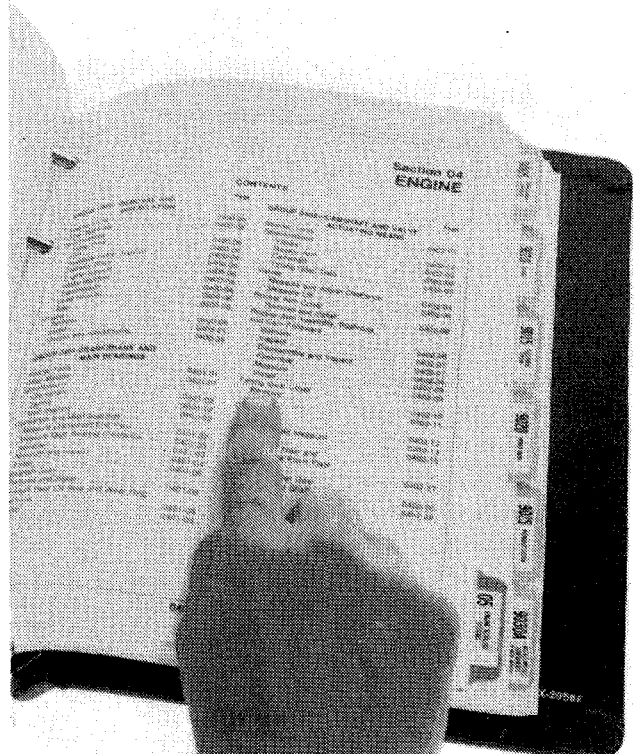

018;T5933AF T82;FLPD M 260785

SAFETY AND YOU

This safety-alert symbol means ATTENTION! BECOME ALERT! YOUR SAFETY IS INVOLVED!

When you see this symbol on your machine or in your manual, be alert to the possibility of personal injury. Follow the instructions in the safety message.



018;T81389 T82;FLPD N 061186

RECOGNIZE SAFETY INFORMATION

This is the safety-alert symbol. When you see this symbol on your machine or in this manual, be alert to the potential for personal injury.

Follow recommended precautions and safe operating practices.

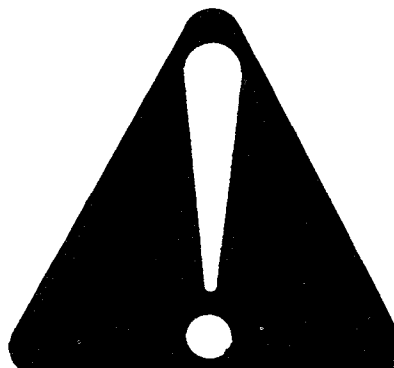

AB6;T81389 053;ALERT 160687

UNDERSTAND SIGNAL WORDS

A signal word—DANGER, WARNING, or CAUTION—is used with the safety-alert symbol. DANGER identifies the most serious hazards.

Safety signs with signal word DANGER or WARNING are typically near specific hazards.

General precautions are listed on CAUTION safety signs. CAUTION also calls attention to safety messages in this manual.



⚠ WARNING

⚠ CAUTION

AB6;TS187 053;SIGNAL 071085

FOLLOW SAFETY INSTRUCTIONS

Carefully read all safety messages in this manual and on your machine safety signs. Follow recommended precautions and safe operating practices.

Keep safety signs in good condition. Replace missing or damaged safety signs.



AB6;TS188 053;SIGNS 071085

USE HANDHOLDS AND STEPS

When you get on and off machine, always maintain a three point contact with steps and handrails and face machine. Do not use any controls as handholds.

Never jump either on or off the machine. Never mount or dismount a moving machine.

Be careful of slippery conditions on platforms, steps, and handrails when mounting or dismounting.



018;T6192AH 02T;;05-FF4 010487

START ENGINE FROM OPERATOR'S SEAT

Avoid possible injury or machine damage. Do not start engine by shorting across starter terminals.

NEVER start engine while standing on ground. Start engine only from operator's seat.

T82;EXSA V 030487

AVOID POWER LINES

Serious injury or death can result from contact with electric lines.

Never move any part of the machine or load closer to electric line than 10 ft (3 m) plus twice the line insulator length. Use a signal person to guide operator. Use shrouds or insulators as necessary.

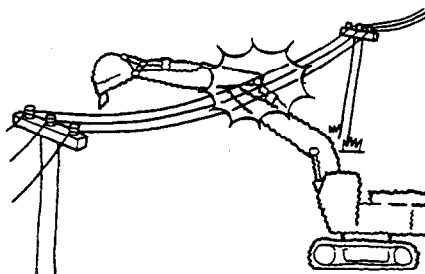

2TA;T5962AX T82;EXSA BI. 300387

KEEP RIDERS OFF MACHINE

Only allow the operator on the machine. Keep riders off.

Riders on machine are subject to injury such as being struck by foreign objects and being thrown off of the machine. Riders also obstruct the operator's view resulting in the machine being operated in an unsafe manner.

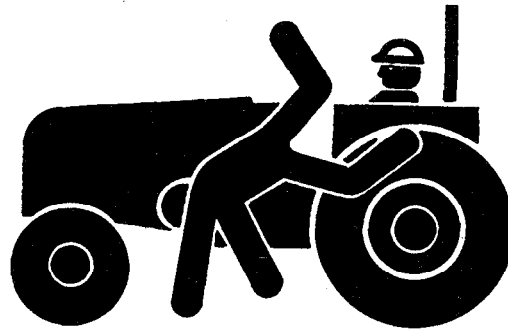

AB6;TS213 053;RIDER 160687

DRIVE EXCAVATOR SAFELY

Before moving excavator, find out which way to move propel pedals for the direction you want to go. Pushing down front of the propel pedals moves the machine towards the idlers.

Keep the bucket on the uphill side, approximately 12 in. (30 cm) above the ground, when ascending or descending slopes. If machine starts to slip or become unstable, lower the bucket immediately.

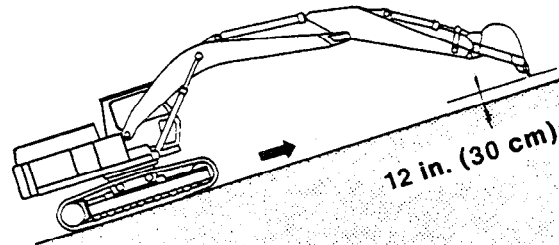

2TA;T5962AZ 02T:05-FF6. 030487

PREPARE FOR EMERGENCIES

Be prepared if a fire starts.

Keep a first aid kit and fire extinguisher handy.

Keep emergency numbers for doctors, ambulance service, hospital, and fire department near your telephone.



AB6;TS186 053;FIRE2 080785

HANDLE FUEL SAFELY—AVOID FIRES

Handle fuel with care: it is highly flammable. Do not refuel the machine while smoking or when near open flame or sparks.

Always stop engine before refueling machine. Fill fuel tank outdoors.

Prevent fires by keeping machine clean of accumulated trash, grease, and debris. Always clean up spilled fuel.



AB6;TS202 053;FIRE1 230487

HANDLE STARTING FLUID SAFELY

Starting fluid is highly flammable.

Keep all sparks and flame away when using it. Keep starting fluid away from batteries and cables.

To prevent accidental discharge when storing the pressurized can, keep the cap on the container, and store in a cool, protected location.

Do not incinerate or puncture a starting fluid container.



AB6;T6098A U 053;FIRE3 160687

PREVENT BATTERY EXPLOSIONS

Battery gas can explode. Keep sparks and flames away from batteries. Use a flashlight to check battery electrolyte level.

Never check battery charge by placing a metal object across the posts. Use a voltmeter or hydrometer.

Always remove grounded (-) clamp first and replace it last.

Do not charge a battery if the battery is frozen as it may explode. Warm battery to 60°F (16°C).



AB6;TS181 02T;05 C78 050287

PROTECT AGAINST NOISE

Prolonged exposure to loud noise can cause impairment or loss of hearing.

Wear a suitable hearing protective device such as earmuffs or earplugs to protect against objectionable or uncomfortable loud noises.

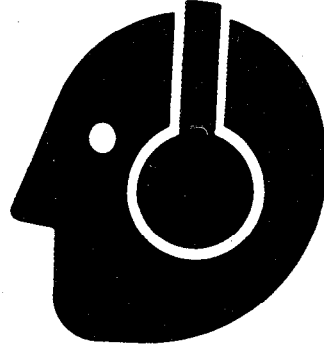

AB6;TS207 053;NOISE 230487

PROTECT AGAINST FLYING DEBRIS

When you drive connecting pins in or out, guard against injury from flying pieces of metal or debris; wear goggles or safety glasses.

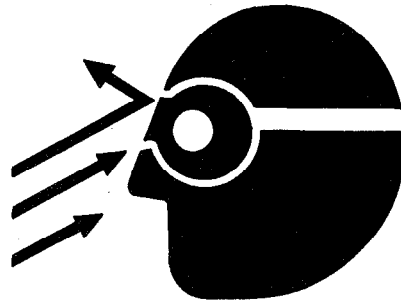

018;T6642DK T82;FLSA AB. 190887

WEAR PROTECTIVE CLOTHING

Wear fairly tight clothing. and safety equipment.

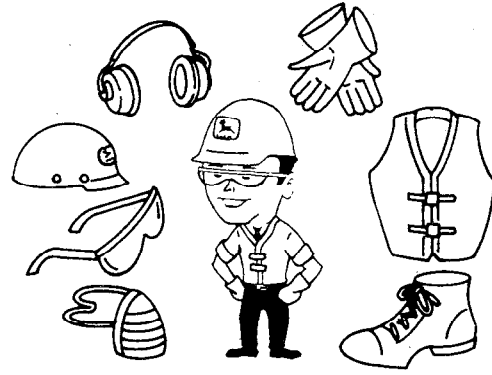

AB6;T85056 053;WEAR1 080785

AVOID HIGH-PRESSURE FLUIDS

Escaping fluid under pressure can penetrate the skin causing serious injury. Relieve pressure before disconnecting hydraulic or other lines. Tighten all connections before applying pressure. Keep hands and body away from pinholes and nozzles which eject fluids under high pressure. Use a piece of cardboard to search for leaks.

If ANY fluid is injected into the skin, it must be surgically removed within a few hours by a doctor familiar with this type injury or gangrene may result.

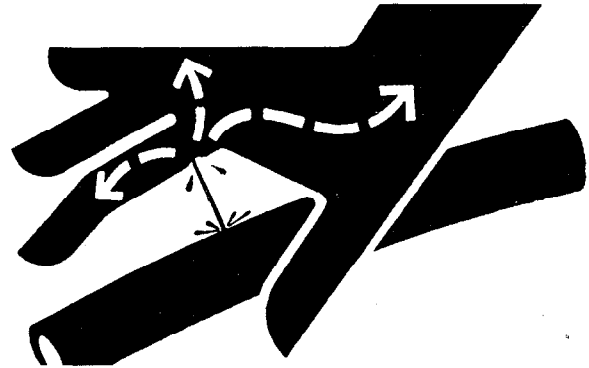

AB6;X9811 053;FLUID 010586

SERVICE EXCAVATOR SAFELY

Never operate the machine if an unsafe condition exists. Attach a "DO NOT OPERATE" tag to the machine.

Be sure you understand a service procedure before working on the machine.

Never lubricate or work on the machine while it is moving.

Always use two people when making checks with the engine running—the operator at the controls, able to see the person doing the checking.

Keep hands away from moving parts.

Never work under a machine raised by the boom. If the machine must be raised, keep a 90—110° angle between boom and arm.

Support the machine in the raised position by placing blocks or jackstands under machine.

Do not work under a raised bucket. Lower bucket to ground or onto blocks.

Disconnect battery ground cable (—) before welding on the machine or making adjustments on the engine or electrical system.



DO NOT OPERATE

018;T6283BH 02T;05 C83. 180387

 **WARNING**

**AVOID SERIOUS CRUSHING
INJURY FROM BOOM**

NEVER place any part of body beyond window bar or frame. It could be crushed by the boom if boom control lever is accidentally bumped or otherwise engaged.

DO NOT remove window bars. If window is missing or broken, replace immediately.

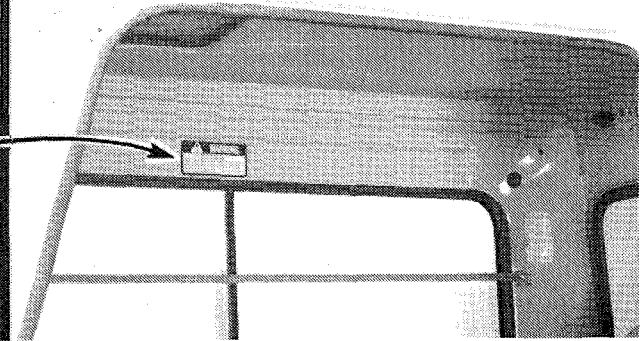



018;T6452AA 02T;;05-FF1. 060487

 **DANGER**

Serious injury or death can result from contact with electric lines. Never move any part of unit or load closer to electric line than 10 feet plus twice the line insulator length.

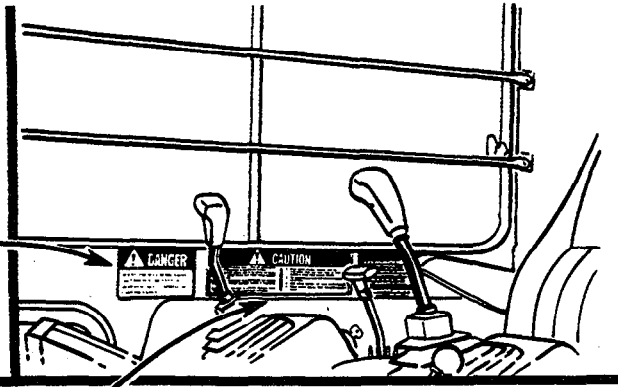
S



 **CAUTION**

- Avoid Death or Serious Injury — Read and understand the Operator Manual and Safety Manual prior to operating this machine.
- **ALWAYS** lower working tools to the ground and engage hydraulic control lockout lever before leaving operators compartment.
- Turn Auto-Idle off when automatic acceleration of engine speed is not desired and when stopping engine.
- Avoid contact between boom/attachments and overhead obstacles whenever operating, traveling or transporting excavator.
- **KEEP** bystanders clear of excavator especially before moving boom, swinging upperstructure or traveling.
- Before moving excavator, determine which way to press travel pedals (when track motor covers are visible, toe pressure on pedals moves excavator rearward).
- Use caution to avoid tipping when swinging heavy loads to side of tracks.
- Avoid parking excavator on an incline.
- Relieve reservoir pressure before working on hydraulic system.

2TA;T6475AK 02T;;05-FF2. 070487

CAUTION

HYDRAULIC FILTER SERVICE

TO PREVENT BURNS FROM HOT OIL AND PREVENT EXCESSIVE OIL LOSS, TAKE THE FOLLOWING STEPS BEFORE REMOVING THE FILTER:

1. POSITION EXCAVATOR ON LEVEL TERRAIN AND STOP ENGINE
2. REMOVE RESERVOIR FILLER CAP SLOWLY TO RELEASE PRESSURE
3. REPLACE FILTERS

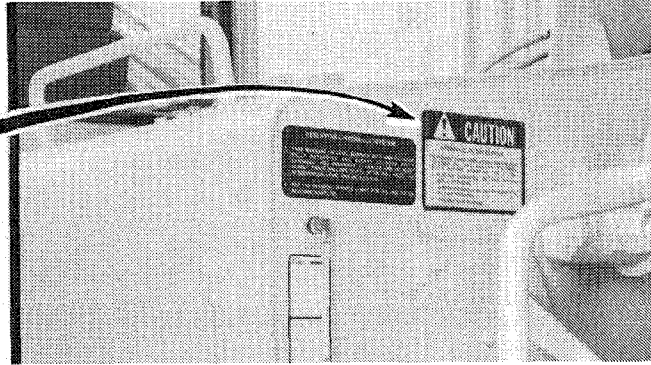

2TA;T6475AL 02T;05-FF3. 240387

DANGER

EXPLOSIVE GASES

Cigarettes, flames or sparks could cause battery to explode. Always shield eyes and face from battery. Do not charge or use booster cables or adjust post connections without proper instruction and training. Keep vent caps tight and level.

POISON

CAUSES SEVERE BURNS

Contains sulfuric acid. Avoid contact with skin, eyes or clothing. In event of accident, flush with water and call a physician immediately. Keep out of reach of children.

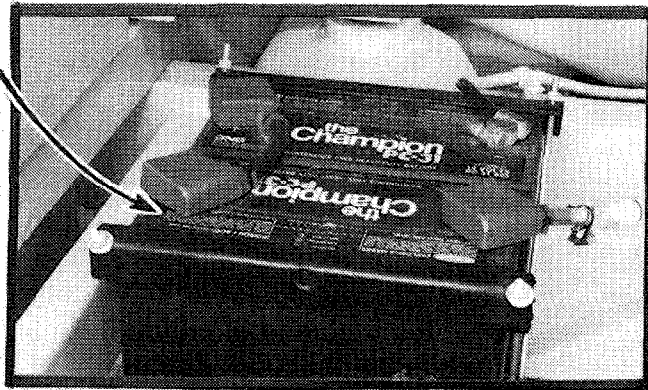

2TA;T6475BD 02T;05 J13. 070487

690D SPECIFICATIONS

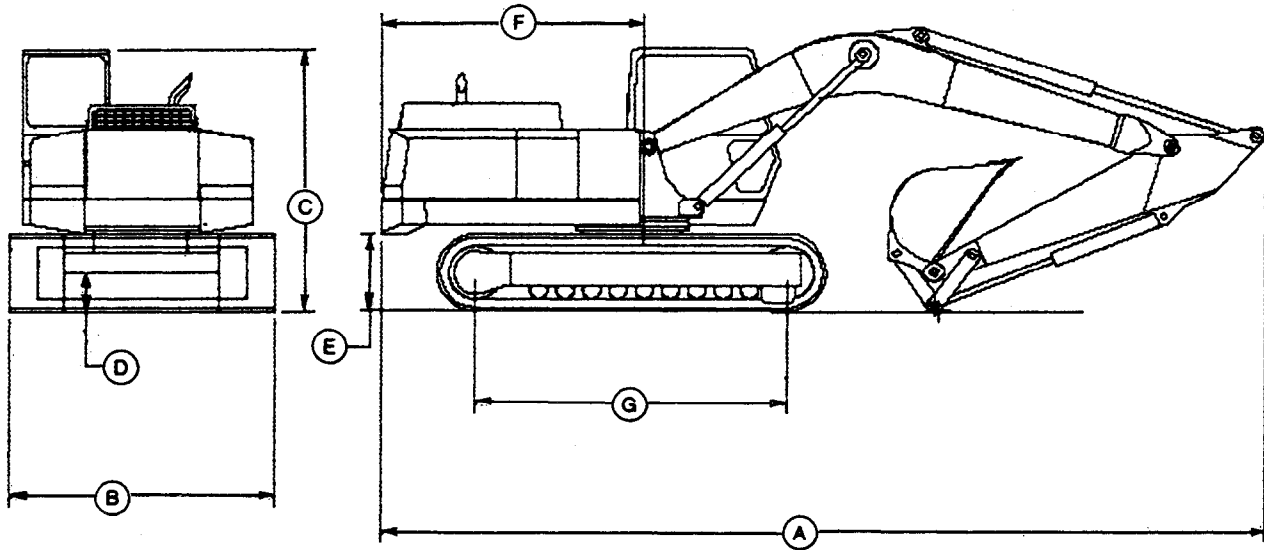

A—Overall length		
2,9 m (9 ft 6 in.) arm	9.62 m (31 ft 7 in.)	
2.2 m (7 ft 3 in.) arm	9.51 m (31 ft 2 in.)	
B—Overall width		
Wide undercarriage		
Wide shoes	3.03 m (9 ft 11 in.)	
Narrow shoes	2.88 m (9 ft 5 in.)	
Narrow undercarriage		
Wide shoes	2.57 m (8 ft 5 in.)	
Narrow shoes	2.42 m (7 ft 11 in.)	
C—Overall height	2.88 m (9 ft 5 in.)	
D—Minimum ground clearance	403 mm (1 ft 4 in.)	
E—Counterweight clearance	832 mm (2 ft 9 in.)	
F—Rear end length	2.72 m (8 ft 11 in.)	
Rear end swing radius	2.78 m (9 ft 2 in.)	
G—Distance between tumbler		
Short track	3.02 m (9 ft. 11 in.)	
Long track	3.36 m (11 ft 0 in.)	

2TA;T6452AN 05T;;115-FF1. 250387

General Specifications

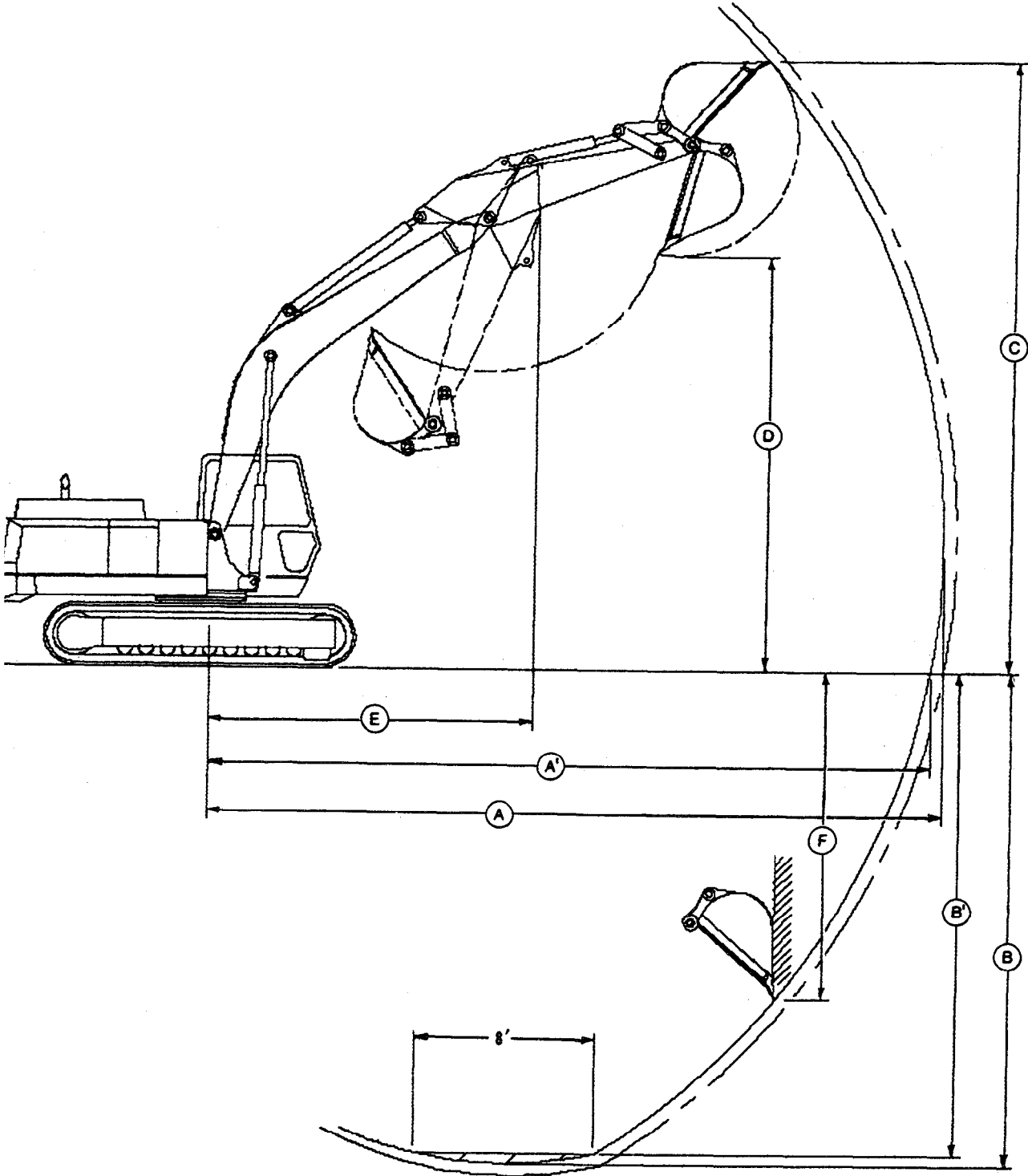

2TA;T6452A0 05T;;115-FF2. 060487

General Specifications

WORKING RANGES

	Standard Arm		Short Arm	
A—Maximum digging reach	10.0 m	(32 ft 10 in.)	9.3 m	(30 ft 7 in.)
A1—Maximum digging reach —On Ground	9.8 m	(32 ft 3 in.)	9.1 m	(30 ft 0 in.)
B—Maximum digging depth	6.7 m	(22 ft 0 in.)	6.0 m	(19 ft 8 in.)
B1—Maximum digging depth 2.44 m (8 ft) level	6.5 m	(21 ft 5 in.)	5.8 m	(18 ft 11 in.)
C—Maximum cutting height	9.4 m	(30 ft 11 in.)	9.0 m	(29 ft 6 in.)
D—Maximum dumping height	6.5 m	(21 ft 4 in.)	6.1 m	(20 ft 1 in.)
E—Minimum swing radius	3.7 m	(12 ft 3 in.)	3.8 m	(12 ft 5 in.)
F—Maximum vertical wall	5.3 m	(17 ft 3 in.)	4.9 m	(16 ft 0 in.)

05T;;115-FF3. 020487

General Specifications

OPERATING WEIGHT

	Kg	Lb
With 600 mm (24 in.) shoes	16 980	37,430
With 750 mm (30 in.) shoes	17 415	38,390

NOTE: Operating weight includes full fuel tank, 79 kg (175 lb) operator, 900 mm (36 in.) bucket, 2.87 m (9 ft 6 in.) arm, 3.81 m (12 ft 6 in.) long by 2.28 m (7 ft 6 in.) wide undercarriage.

05T;;115-FF4. 240887

DRAIN AND REFILL CAPACITIES

Fuel tank	266 L	70 gal
Cooling system	29.3 L	31 qt
Engine lubrication, including filter.	19 L	20 qt
Hydraulic reservoir	250 L	66 gal
Swing gear	13.6 kg	30 lb
Propel drive (each)	5.5 L	5.8 qt

05T;;115-FF5. 310387

General Specifications

Engine: John Deere 6-414T

Type	4-stroke cycle, turbocharged diesel
Bore and stroke	106.4 x 127 mm (4.19 x 5 in.)
Number of cylinders	6
Displacement	6.8 L (414 cu in.)
Compression ratio	16.8:1
Maximum net torque at 1300 rpm	569 N·m (58 kg·m)(420 lb-ft)
Lubrication	Pressure system with full-flow filter
Cooling fan	Suction type viscous drive
Air cleaner	Dry
Electrical system	24 volt with 42 amp alternator
Batteries (2) 12 volt	Reserve capacity: 160 minutes

Power at 2000 engine rpm	SAE
Net	93 kW (125 hp)

Hydraulic System:

Closed center. Two variable-displacement axial-piston pumps with load-sensing and constant torque control in tandem are directly coupled to engine. Main control valves are pressure and flow compensated to provide independent and load independent combined operation for all functions. A pad is provided for auxiliary function valve attachment.

Main pumps	2 variable-displacement axial piston
Minimum pump/section flow at 29993 kPa (300 bar) (4350 psi) @ 2000 rpm	56.8 L/min (15 gpm)
Maximum rated flow at 9998 kPa (100 bar) (1450 psi) @ 2000 rpm	189.3 L/min (50 gpm)

Pilot pump at	One gear
Minimum rated flow at 2000 rpm.	30.2 L/min (8 gpm)

System operating pressure

Implement circuits	28 000 kPa (286 kg/cm ²) (4060 psi)
Travel circuits.	32 500 kPa (332 kg/cm ²) (4700 psi)

Relief valve settings

Implement circuits	30 000 kPa (306 kg/cm ²) (4350 psi)
Travel circuits.	33 300 kPa (333 kg/cm ²) (4830 psi)
Swing circuits.	24 130 kPa (246 kg/cm ²) (3500 psi)

Oil filtration:

Two 4-micron spin-on full flow return filters with bypass.
One 40-micron pilot oil filter.

NOTE: Specifications and design subject to change without notice. Wherever applicable, specifications are in accordance with PCSA and SAE standards. Except where otherwise noted, these specifications are based on a unit equipped with 900 mm (36 in.) bucket, full fuel tank, 79 kg (175 lb) operator and standard equipment.

05T;;115-FF6. 040287

General Specifications

BUCKET SPECIFICATIONS

Nominal Width	Bite Width	Capacity SAE (Heaped)	Weight
Regular Duty:			
600 mm (24 in.)	648 mm (25.5 in.)	0.43 m ³ (0.56 cu yd)	455 kg (1000 lb)
750 mm (30 in.)	800 mm (31.5 in.)	0.57 m ³ (0.75 cu yd)	500 kg (1100 lb)
900 mm (36 in.)	953 mm (37.5 in.)	0.67 m ³ (0.88 cu yd)	545 kg (1200 lb)
1.07 m (42 in.)	1.11 m (43.5 in.)	0.76 m ³ (1 cu yd)	590 kg (1300 lb)
1.22 m (48 in.)	1.26 m (49.5 in.)	0.76 m ³ (1 cu yd)	545 kg (1200 lb)
1.52 m (60 in.)	1.52 m (60.0 in.)	1.05 m ³ (1.38 cu yd)	
Heavy Duty:			
600 mm (24 in.)	660 mm (26.0 in.)	0.48 m ³ (0.625 cu yd)	625 kg (1380 lb)
740 mm (29 in.)	787 mm (31.0 in.)	0.57 m ³ (0.75 cu yd)	680 kg (1500 lb)
890 mm (35 in.)	940 mm (37.0 in.)	0.57 m ³ (0.75 cu yd)	690 kg (1525 lb)
890 mm (35 in.)	940 mm (37.0 in.)	0.8 m ³ (1.00 cu yd)	714 kg (1574 lb)

05T;115-FF7. 310387

General Specifications

RECOMMENDED BUCKET SIZE

Lb/Yd ³	kg/m ³	Material	Regular Duty		Heavy Duty	
700	420	Wood chips	5 cu yd	3.83 m ³	_____	_____
810	480	Peat dry	4.5 cu yd	3.44 m ³	_____	_____
1242	740	Peast wet	3 cu yd	2.3 m ³	_____	_____
1450	860	Cinders	2.5 cu yd	1.9 m ³	_____	_____
2000	1186	Topsoil	1.8 cu yd	1.4 m ³	_____	_____
2600	1540	Earth dry loam	1.38 cu yd	1.05 m ³	_____	_____
2700	1600	Sand dry	1.38 cu yd	1.05 m ³	1 cu yd	0.76 m ³
3000	1780	Coal natural bed	1.21 cu yd	0.93 m ³	1 cu yd	0.76 m ³
3200	1900	Earth moist loam	1.12 cu yd	0.93 m ³	0.88 cu yd	0.67 m ³
3250	1930	Sand gravel dry	1.12 cuyd	0.93 m ³	0.88 cu yd	0.67 m ³
3300	1960	Sand moist	1.12 cu yd	0.93 m ³	0.88 cu yd	0.67 m ³
3500	2080	Sand wet	1 cu yd	0.77 m ³	0.75 cu yd	0.57 m ³
3500	2080	Shale	1 cu yd	0.77 m ³	0.75 cu yd	0.57 m ³
3600	2100	Clay wet	0.88 cu yd	0.67 m ³	0.62 cu yd	0.48 m ³
4200	2490	Limestone broken	_____	_____	0.62 cu yd	0.48 m ³
4600	2730	Rock granite blasted	_____	_____	0.62 cu yd	0.48 m ³

NOTE: Contact your John Deere dealer for optimum bucket and attachment selection. The use of larger than recommended buckets in heavy materials and tough conditions should be thoroughly analyzed for digging force and load capacity. Bucket capacity indicated is SAE heaped.

05T;115 FF8. 060487



Suggest:

If the above button click is invalid.

Please download this document

first, and then click the above link

to download the complete manual.

Thank you so much for reading

LIFT CAPACITY—KG (LB)

Undercarriage: 3.81 m (12 ft 6 in.) x 2.28 m (7 ft 6 in.)

Arm: 2.20 m (7 ft 3 in.)

Ratings at bucket lift point, machine situated on firm, uniform supporting surface. Total load includes weight of cables, etc. Figures marked with an * are hydraulically limited capacities. Remaining figures are stability-limited capacities. Hydraulically limited capacities are not increased by an additional counterweight. Figures do not exceed 87% of hydraulic capacities or 75% of weight needed to tip machine.

LIFTING OVER FRONT OR REAR

Load Point Height m (ft)	Horizontal Distance from Centerline of Rotation				9.14 (30)
	3.05 (10)	4.57 (15)	6.10 (20)	7.62 (25)	
6.10 (20)			3 840 (8,480)	2 590 (5,710)	
4.57 (15)		4 960 (10,940)*	3 720 (8,210)	2 470 (5,440)	
3.05 (10)		5 640 (12,430)	3 510 (7,750)	2 380 (5,250)	
1.52 (5)		5 250 (11,570)	3 310 (7,300)	2 290 (5,050)	
Ground Line		5 170 (11,140)	3 180 (7,010)	2 230 (4,910)	
-1.52 (-5)	6 270 (13,810)*	5 050 (11,400)	3 150 (6,930)	2 230 (4,910)	
-3.05 (-10)	9 930 (21,890)	5 150 (11,350)	3 210 (7,070)		
-4.57 (-15)		5 380 (11,870)			

LIFTING OVER THE SIDE OR 360°

6.10 (20)			2 890 (6,380)	1 970 (4,240)
4.57 (15)		4 590 (10,110)	2 780 (6,130)	1 810 (3,980)
3.05 (10)		4 090 (9,030)	2 580 (5,690)	1 730 (3,800)
1.52 (5)		3 740 (8,250)	2 390 (5,270)	1 640 (3,610)
Ground Line		3 560 (7,860)	2 270 (5,000)	1 580 (3,480)
-1.52 (-5)	6 270 (13,810)*	3 560 (7,860)	2 240 (4,930)	1 580 (3,480)
-3.05 (-10)	7 520 (16,570)	3 650 (8,040)	2 290 (5,060)	
-4.57 (-15)		3 860 (8,520)		

Stability-limited lift capacities are increased:

- a. 3% if machine is equipped with 750 mm (30 in.) shoes.
- b. 8% if machine is equipped with 500 kg (1100 lb) optional counterweight.
- c. 16% if machine is equipped with 1000 kg (2200 lb) optional counterweight.

Stability-limited, over-side lift capacities are decreased:

- a. 20% if machine is equipped with 1.82 m (6 ft) undercarriage.

<https://www.ebooklibonline.com>

Hello dear friend!

Thank you very much for reading.

Enter the link into your browser.

The full manual is available for immediate download.

<https://www.ebooklibonline.com>