

**John Deere
495D
Excavator
Repair**

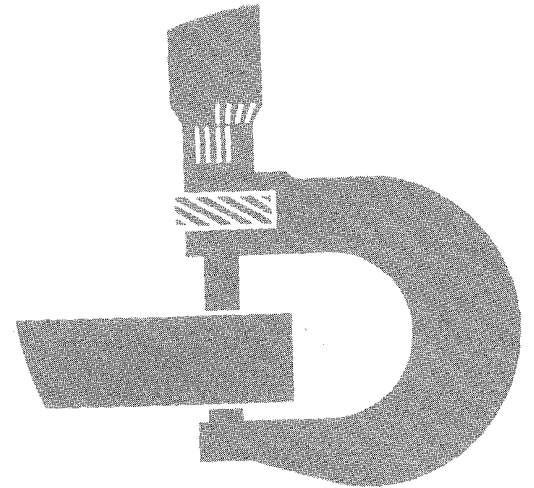

TECHNICAL MANUAL

TM-1457 (Feb-89)
LITHO IN U.S.A.

Introduction

FOREWORD

This manual is written for an experienced technician. Essential tools required in performing certain service work are identified in this manual and are recommended for use.

Live with safety: Read the safety messages in the introduction of this manual and the cautions presented throughout the text of the manual.



This is the safety-alert symbol. When you see this symbol on the machine or in this manual, be alert to the potential for personal injury.

Technical manuals are divided in two parts: repair and diagnostics. Repair sections tell how to repair the components. Diagnostic sections help you identify the majority of routine failures quickly.

Information is organized in groups for the various components requiring service instruction. At the beginning of each group are summary listings of all applicable essential tools, service equipment and tools, other materials needed to do the job, service parts kits, specifications, wear tolerances, and torque values.

Binders, binder labels, and tab sets can be ordered by John Deere dealers direct from the John Deere Distribution Service Center.

This manual is part of a total product support program.

FOS Manuals-reference

Technical Manuals-machine service

Component Manuals-component service

Fundamentals of Service (FOS) Manuals cover basic theory of operation, fundamentals of troubleshooting, general maintenance, and basic types of failures and their causes. FOS Manuals are for training new personnel and for reference by experienced technicians.

Technical Manuals are concise guides for specific machines. Technical manuals are on-the-job guides containing only the vital information needed for diagnosis, analysis, testing, and repair.

Component Technical Manuals are concise service guides for specific components. Component technicals manuals are written as stand-alone manuals covering multiple machine applications.

495D EXCAVATOR TECHNICAL MANUAL TM-1457 (FEB-89)

SECTION AND GROUP CONTENTS

NOTE: This manual covers machine repair. For operation and tests information, see TM-1456.

SECTION I—GENERAL INFORMATION

- Group I—Safety
- Group II—General Specifications
- Group III—Torque Values
- Group IV—Fuels and Lubricants
- Group V—Inspection Procedures

SECTION 01—WHEELS

- Group 0110—Powered Wheels and Fastenings

SECTION 02—AXLES AND SUSPENSION SYSTEMS

- Group 0200—Removal and Installation
- Group 0210—Differential or Bevel Drive
- Group 0225—Input Drive Shafts and U-Joints
- Group 0250—Axle Shafts, Bearings and Reduction Gears
 - Tow Excavator, Hub Reduction,
 - Steering Knuckle, Front and Rear
 - Axle Housings

SECTION 03—TRANSMISSION

- Group 0300—Removal and Installation
- Group 0350—Gears, Shafts, Bearings, and Power Shift Clutch
 - Transmission, 2WD-4WD
 - Shift Unit, Front Output Housing,
 - Bevel Gear Housing, and Pinion Shaft
- Group 0360—Hydraulic System
 - Travel (Transmission Drive)
 - Motor, Counterbalance Valve, and Rotary Manifold

SECTION 04—ENGINE

NOTE: For engine, 4.5L (276 cu in.), repair, see CTM-4.

- Group 0400—Removal and Installation
 - Engine, Fuel Injection Pump, Fuel Injection Nozzles, Bleed Fuel System, Turbocharger, Fuel Transfer Pump, Water Pump, Intake Manifold, Exhaust Manifold and Engine Oil Cooler

SECTION 05—ENGINE AUXILIARY SYSTEMS

- Group 0505—Cold Weather Starting Aids
 - Starting Aid Solenoid, Nozzle and Engine Coolant Heater
- Group 0510—Cooling System
 - Fan, Fan Belt and Radiator
- Group 0515—Speed Controls
 - Speed Control Assembly and Linkage
- Group 0520—Intake System
 - Air Cleaner and Air Intake System
 - Leakage Test
- Group 0560—External Fuel Supply System

SECTION 07—DAMPENER DRIVE (FLEX COUPLING)

- Group 0752—Elements

SECTION 09—STEERING SYSTEM

- Group 0960—Hydraulic System
 - Steering Valve, Pump, Flow Regulator, Switch Valve, Cylinder, Crossover Relief Valve

Continued on next page

All information, illustrations and specifications contained in this technical manual are based on the latest information available at the time of publication. The right is reserved to make changes at any time without notice.

COPYRIGHT© 1989
DEERE & COMPANY
Moline, Illinois
All rights reserved
A John Deere ILLUSTRATION™ Manual

TX.1457 CC1 170589

<https://www.ebooklibonline.com>

Hello dear friend!

Thank you very much for reading.

Enter the link into your browser.

The full manual is available for immediate download.

<https://www.ebooklibonline.com>

SECTION 10—SERVICE BRAKES

- Group 1011—Active Elements
- Group 1060—Hydraulic System

SECTION 11—PARK BRAKE

- Group 1111—Active Elements

SECTION 16—ELECTRICAL SYSTEM

- Group 1671—Batteries, Support and Cables
- Group 1672—Alternator, Regulator and Charging System Wiring
- Group 1674—Wiring Harness and Switches
- Group 1676—Instruments and Indicators
- Group 1677—Motors and Actuators
 - Starting Motor

SECTION 17—FRAME, CHASSIS, OR SUPPORTING STRUCTURE

- Group 1740—Frame Installation
- Group 1749—Chassis Weights

SECTION 18—OPERATOR'S STATION

- Group 1800—Removal and Installation
 - Cab (Without Floor)
- Group 1810—Operator Enclosure
 - Window Panes, Cab Door and Latch, Door Release Handle, Windshield Washer and Wiper
- Group 1821—Seat
- Group 1830—Heater and Air Conditioning

SECTION 19—SHEET METAL AND STYLING

- Group 1910—Hood or Engine Enclosure

SECTION 20—SAFETY, CONVENIENCE, AND MISCELLANEOUS

- Group 2004—Horn and Warning Devices

SECTION 22—PNEUMATIC SYSTEM

- Group 2261—Pump and Drives
 - Air Compressor, Idle Pulley
- Group 2262—Control Valves
 - Control Valves, Relief Valves
- Group 2264—Reservoir, Filter, and Trap
 - Air Dryer, Air Horn

SECTION 32—BULLDOZERS

- Group 3200—Removal and Installation
- Group 3260—Hydraulic System

SECTION 33—EXCAVATOR

- Group 3302—Buckets
 - Bucket, Linkage, Bushings, Tooth Tip and Tooth Shank
- Group 3340—Frames
 - Arm, Boom and Bushings
- Group 3360—Hydraulic System
 - Hydraulic Pump, Hydraulic Pump Regulator, Rate-of-Shift Valve, Travel Solenoid Valve, Maximum Displacement Valve, Pilot Pump, Pilot Filter, Pilot Shut-Off Valve, Pilot Pressure Regulating Valve and Solenoid Valve, Mode Selection Cylinders, Main Control Valve, System Relief Valves, Flow Sense Valves, Restriction Valve, Stabilizer and Blade Solenoid Valves, Diverter Valves, Shuttle Check Valves, Reservoir, Reservoir Cap, Return Filter and Bypass Valve, Suction Filter, Oil Cooler, Bypass Valve, Cylinders, Travel Pilot Controller, Dig Function Pilot Controller, Auxiliary Pilot Controller, F-N-R Shift Valve, Flow Regulator Valve, Axle Lock Lockout Valve, Stabilizer Lockout Valve and Pressure Reducing Valve

SECTION 43—SWING, ROTATION, OR PIVOTING SYSTEM

- Group 4311—Brakes
- Group 4350—Mechanical Drive Elements
 - Swing Gearbox and Swing Bearing
- Group 4360—Hydraulic System
 - Swing Motor, Crossover Relief Valves, Make-up Valves and Swing Brake Release Valve

SECTION 99—DEALER FABRICATED TOOLS

- Group 9900—Dealer Fabricated Tools

TX,1457 CC2 170589

HANDLE FLUIDS SAFELY—AVOID FIRES

When you work around fuel, do not smoke or work near heaters or other fire hazards.

Store flammable fluids away from fire hazards. Do not incinerate or puncture pressurized containers.

Make sure machine is clean of trash, grease, and debris.

Do not store oily rags; they can ignite and burn spontaneously.



AB6;TS227 053;FLAME 050188

PREVENT BATTERY EXPLOSIONS

Keep sparks, lighted matches, and open flame away from the top of battery. Battery gas can explode.

Never check battery charge by placing a metal object across the posts. Use a volt-meter or hydrometer.

Do not charge a frozen battery; it may explode. Warm battery to 16°C (60°F).



AB6;TS204 053;SPARKS 280688

PREPARE FOR EMERGENCIES

Be prepared if a fire starts.

Keep a first aid kit and fire extinguisher handy.

Keep emergency numbers for doctors, ambulance service, hospital, and fire department near your telephone.

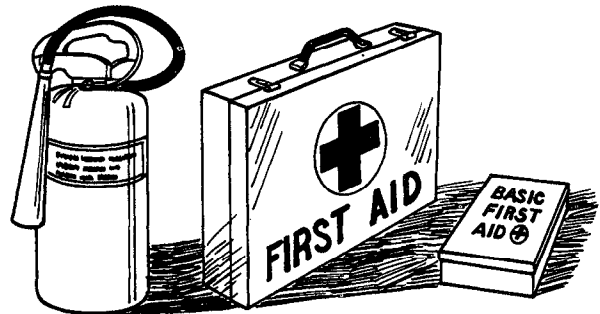

AB6;TS186 053;FIRE2 080785

PREVENT ACID BURNS

Sulfuric acid in battery electrolyte is poisonous. It is strong enough to burn skin, eat holes in clothing, and cause blindness if splashed into eyes.

Avoid the hazard by:

1. Filling batteries in a well-ventilated area.
2. Wearing eye protection and rubber gloves.
3. Avoiding breathing fumes when electrolyte is added.
4. Avoiding spilling or dripping electrolyte.
5. Use proper jump start procedure.

If you spill acid on yourself:

1. Flush your skin with water.
2. Apply baking soda or lime to help neutralize the acid.
3. Flush your eyes with water for 10-15 minutes. Get medical attention immediately.

If acid is swallowed:

1. Drink large amounts of water or milk.
2. Then drink milk of magnesia, beaten eggs, or vegetable oil.
3. Get medical attention immediately.

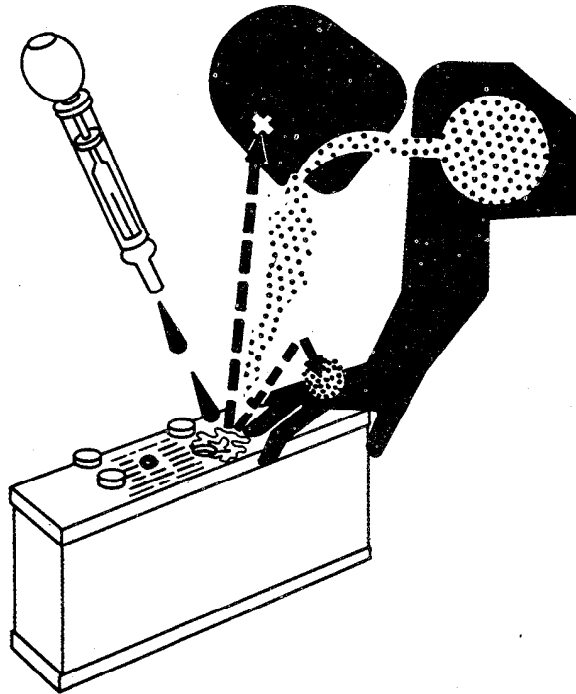

AB6;TS203 053;POISON 211287

AVOID HIGH-PRESSURE FLUIDS

Escaping fluid under pressure can penetrate the skin causing serious injury. Relieve pressure before unhooking hydraulic or other lines. Tighten all connections before applying pressure. Keep hands and body away from pinholes and nozzles which eject fluids under high pressure. Use a piece of cardboard to search for leaks.

If ANY fluid is injected into the skin, it must be surgically removed within a few hours by a doctor familiar with this type injury or gangrene may result.



AB6;X9811 053;FLUID 180987

PARK MACHINE SAFELY

Before working on the machine:

- Lower all equipment to the ground.
- Stop the engine and remove the key.
- Disconnect the battery ground strap.
- Hang a "DO NOT OPERATE" tag in operator station.

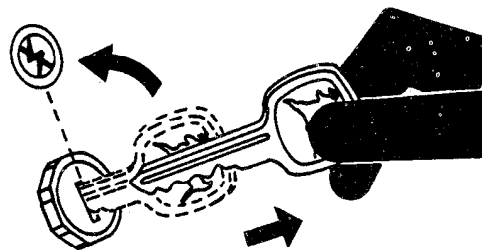

AB6;TS230 053;PARK 050188

SUPPORT MACHINE PROPERLY

Always lower the attachment or implement to the ground before you work on the machine. If you must work on a lifted machine or attachment, securely support the machine or attachment.

Do not support the machine on cinder blocks, hollow tiles, or props that may crumble under continuous load. Do not work under a machine that is supported solely by a jack. Follow recommended procedures in this manual.

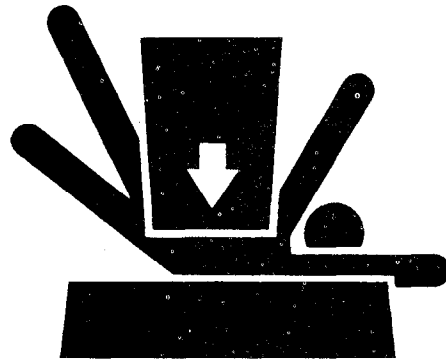

AB6;TS229 053;LOWER 211287

WEAR PROTECTIVE CLOTHING

Wear close fitting clothing and safety equipment appropriate to the job.

Prolonged exposure to loud noise can cause impairment or loss of hearing.

Wear a suitable hearing protective device such as earmuffs or earplugs to protect against objectionable or uncomfortable loud noises.

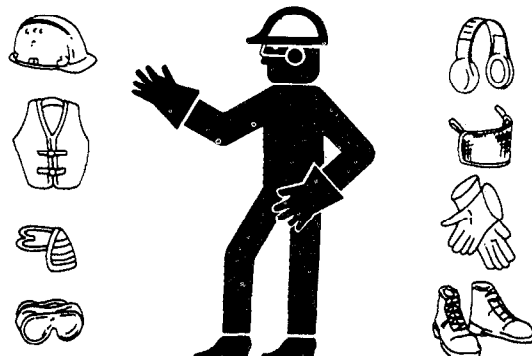

AB6;TS206 053;WEAR 230487

SERVICE MACHINE SAFELY

Tie long hair behind your head. Do not wear a necktie, scarf, loose clothing, or necklace when you work near machine tools or moving parts. If these items were to get caught, severe injury could result.

Remove rings and other jewelry to prevent electrical shorts and entanglement in moving parts.

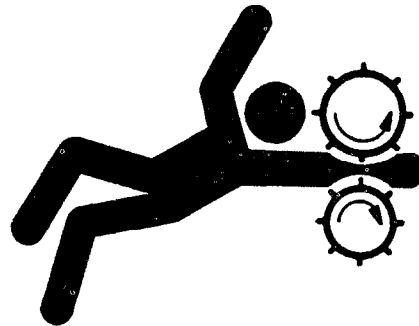

AB6;TS228 053;LOOSE 211287

WORK IN VENTILATED AREA

Engine exhaust fumes can cause sickness or death. If it is necessary to run an engine in an enclosed area, remove the exhaust fumes from the area with an exhaust pipe extension.

If you do not have an exhaust pipe extension, open the doors and get outside air into the area.



AB6;TS220 053;AIR 050188

UNDERSTAND CORRECT SERVICE

Illuminate your work area adequately but safely. Use a portable safety light for working inside or under the machine. Make sure the bulb is enclosed by a wire cage. The hot filament of an accidentally broken bulb can ignite spilled fuel or oil.

Catch draining fuel, oil, or other fluids in suitable containers. Do not use food or beverage containers that may mislead someone into drinking from them. Wipe up spills at once.

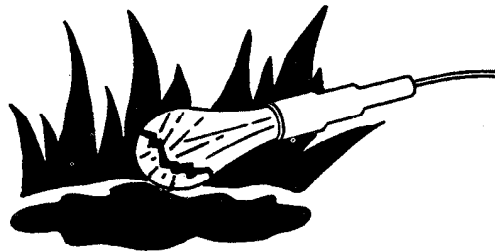

AB6;TS223 053;LIGHT 230288

REPLACE SAFETY SIGNS

Replace missing or damaged safety signs. See the machine operator's manual for correct safety sign placement.



AB6;TS201 053;SIGNS1 221287

USE PROPER LIFTING EQUIPMENT

Lifting heavy components incorrectly can cause severe injury or machine damage.

Follow recommended procedure for removal and installation of components in the manual.

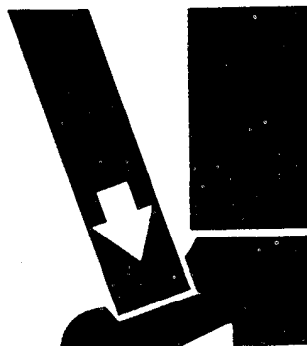

AB6;TS226 053;LIFT 050188

SERVICE TIRES SAFELY

Explosive separation of a tire and rim parts can cause serious injury or death.

Do not attempt to mount a tire unless you have the proper equipment and experience to perform the job.

Always maintain the correct tire pressure. Do not inflate the tires above the recommended pressure.

When inflating tires, use a clip-on chuck and extension hose long enough to allow you to stand to one side and NOT in front of or over the tire assembly. Use a safety cage if available.

Check wheels for low pressure, cuts, bubbles, damaged rims or missing lug bolts and nuts.

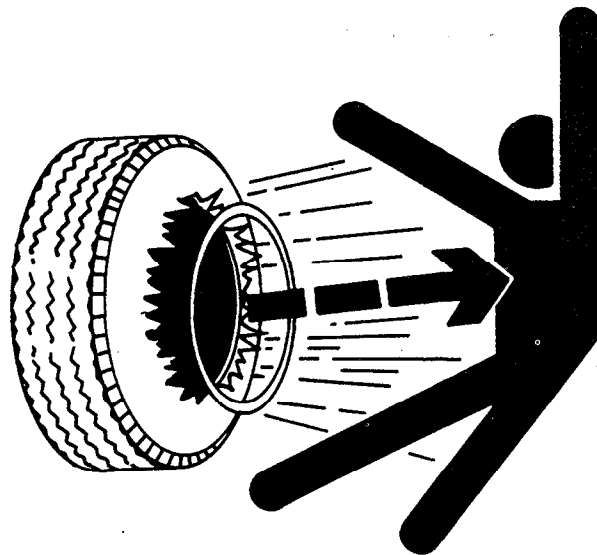

AB6;TS211 053;RIM 211287

AVOID HARMFUL ASBESTOS DUST

Avoid breathing dust that may be generated when handling components containing asbestos fibers. Inhaled asbestos fibers may cause lung cancer.

Components in John Deere products that may contain asbestos fibers are brake pads, brake band and lining assemblies, clutch plates, and some gaskets. The asbestos used in these components is usually found in a resin or sealed in some way. Normal handling is not hazardous as long as airborne dust containing asbestos is not generated.

Avoid creating dust. Never use compressed air for cleaning. Avoid brushing or grinding of asbestos containing materials. When servicing, wear an approved respirator. A special vacuum cleaner is recommended to clean asbestos. If not available, wet the asbestos containing materials with a mist of oil or water.

Keep bystanders away from the area.

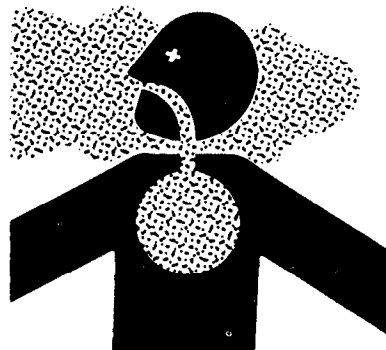

AB6;TS220 053;DUST 140488

WORK IN CLEAN AREA

Before starting a job:

- Clean work area and machine.
- Make sure you have all necessary tools to do your job.
- Have the right parts on hand.
- Read all instructions thoroughly; do not attempt shortcuts.

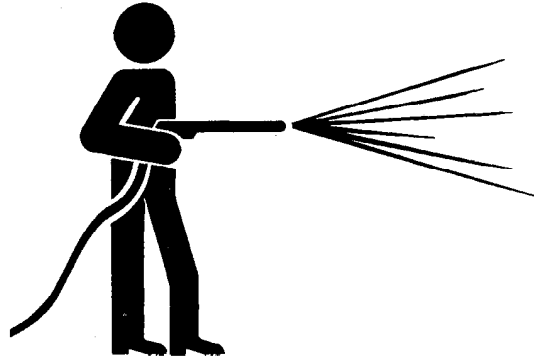

AB6;T6642E J 053;CLEAN 190188

USE TOOLS PROPERLY

Use tools appropriate to the work. Makeshift tools, parts, and procedures will not make good repairs.

Use pneumatic and electric tools only to loosen threaded parts and fasteners. Never use such tools to tighten fasteners, especially on light alloy parts.

Use only replacement parts meeting John Deere specifications.

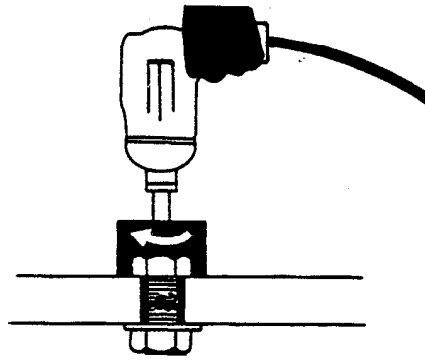

AB6;TS221 053;REPAIR 211287

DISPOSE FLUIDS PROPERLY

Be mindful of the environment and ecology. Before you drain fluids, find out the proper way to dispose of the oil.

Do not pour oil onto the ground, down a drain, or into a stream, pond, or lake. Consult local ordinances that govern the disposal of wastes.

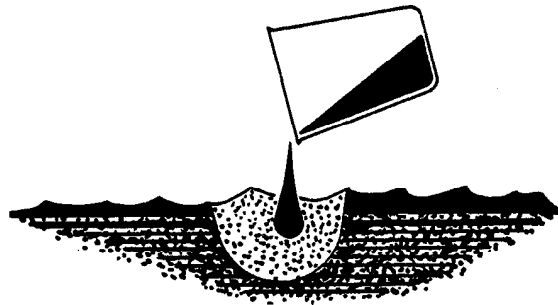

AB6;TS222 053;DRAIN 211287

LIVE WITH SAFETY

Before returning machine to customer, make sure machine is functioning properly, especially the safety systems. Install all guards and shields.



AB6;TS231 053;LIVE 050188

495D EXCAVATOR

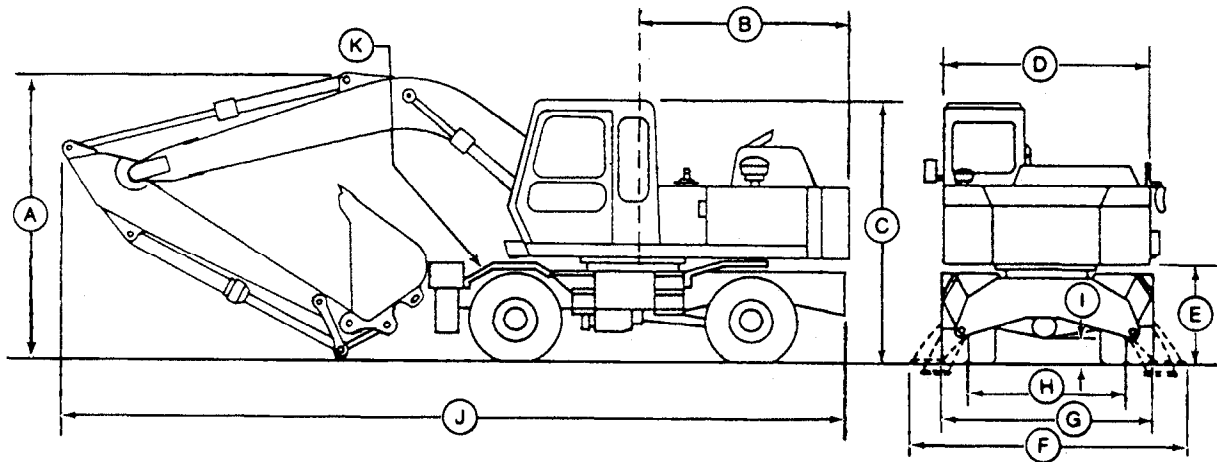

A—Overall Height of Boom	3 510 mm (11'6") with 1.95 m (6'5") arm 3 700 mm (12'2") with 2.25 m (7'5") arm
B—Rear-end swing radius	2 100 mm (6'11")
Rear-end length	2 090 mm (6'10")
C—Cab Height	2 980 mm (9'9")
D—Superstructure Width	2 380 mm (7'10")
E—Superstructure clearance	1 210 mm (4'0")
F—Overall Width of outrigger extended	3 190 mm (10'6")
G—Center to center width of outrigger	2 890 mm (9'6")
H—Overall width (undercarriage width)	2 470 mm (8'1")
I—Minimum ground clearance	315 mm (1'0")
J—Overall length	6 910 mm (22'8") with 1.95 m (6'5") arm 7 080 mm (23'3") with 2.25 m (7'5") arm
K—REAR END OF UNDERCARRIAGE	

024;T6866AE 05T;115 M61 020888

WORKING RANGES

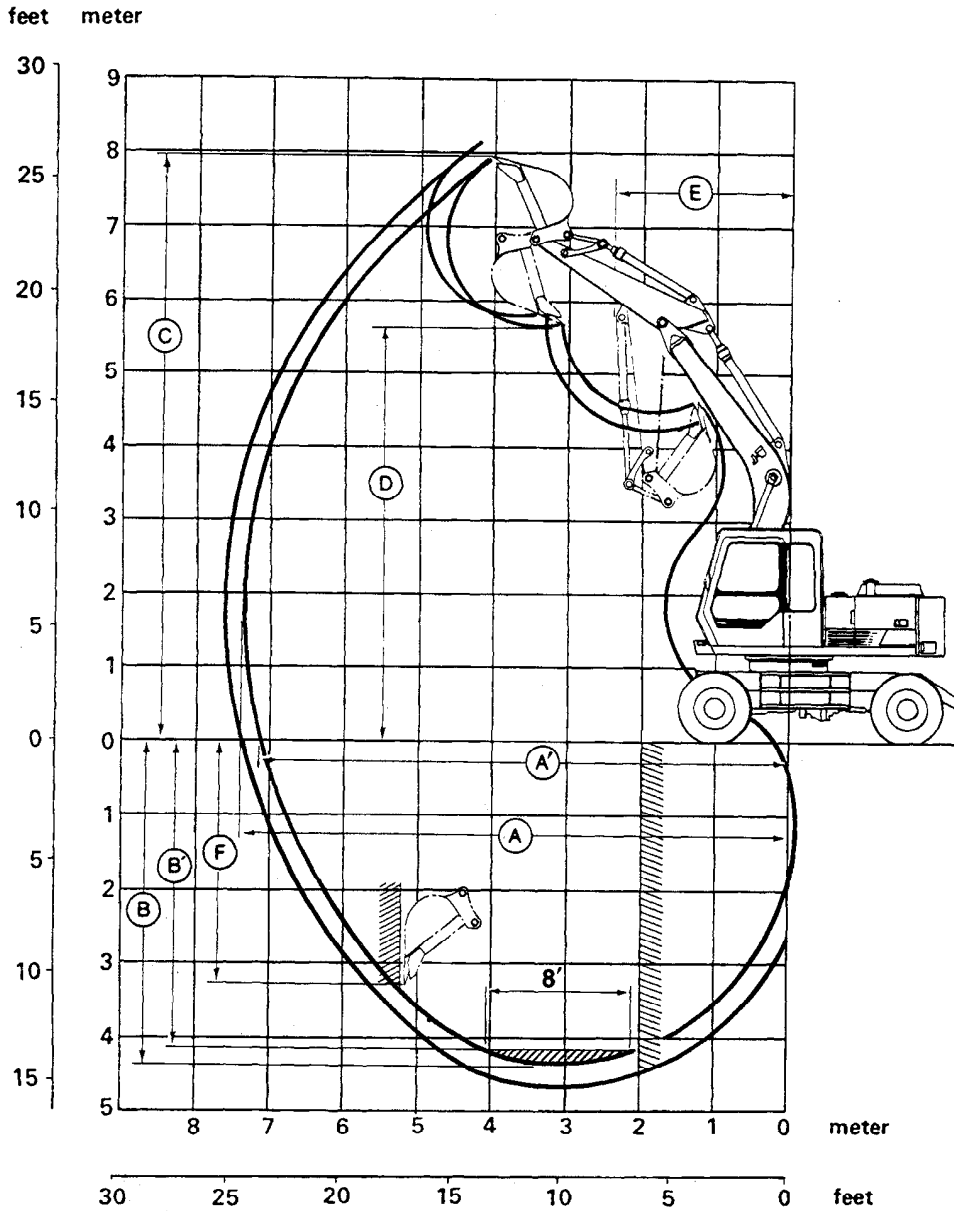

	1.95 m (6'5") arm	2.25 m (7'5") arm
A—Max. digging reach	7 410 mm (24'4")	7 680 mm (25'2")
A'—Max. digging reach (on ground)	7 180 mm (23'7")	7 450 mm (24'5")
B—Max. digging depth	4 410 mm (14'6")	4 710 mm (15'5")
B'—Max. digging depth (8' level)	4 150 mm (13'7")	4 470 mm (14'8")
C—Max. cutting height	7 950 mm (26'1")	8 100 mm (26'7")
D—Max. dumping height	5 600 mm (18'4")	5 740 mm (18'10")
E—Min. swing radius	2 460 mm (8'1")	2 640 mm (8'8")
F—Max. vertical wall	3 320 mm (10'11")	3 800 mm (12'6")

024;T6866AF 05T;115 M62 030888

495D EXCAVATOR SPECIFICATIONS

Specifications and design subject to change without notice. Wherever applicable, specifications are in accordance with PCSA and SAE Standards. except where otherwise noted, these specifications are based on a unit with full fuel tank, 175 lb (80 kg) operator and standard equipment.

Engine: John Deere 4-276T

Type 4-stroke cycle, turbocharged diesel
 Bore and stroke .. 4.19 x 5.00 in. (106.5 x 127 mm)
 No. of cylinders 4
 Displacement 276 cu. in. (4.524 L)
 Compression ratio 17.2 to 1
 Maximum net torque @ 1300 rpm 284 lb-ft
 (385 N·m) (39.3 kg·m)
 Lubrication Pressure system with full flow filter
 Coolant fan Suction type
 Electrical system ... 24-volt with 42-amp alternator
 Batteries (two 12-volt) Reserve
 capacity: 180 minutes

Rated Power	SAE	DIN 70 020
@ 2100 rpm (Dig Mode):		
Net	95 hp (71 kW)	71 kW
Gross	100 hp (75 kW)	
@ 2300 rpm (Travel Mode):		
Net	100 hp (75 kW)	75 kW
Gross	105 hp (78 kW)	

Net engine power is with standard equipment including air cleaner, exhaust system, alternator, and cooling fan, at standard conditions per SAE J1349 and DIN 70 020, using NO. 2-D fuel @ 35 API gravity. No derating is required up to 10,000 ft (3050 m) altitude. Gross power is without cooling fan.

Hydraulic System: Open center

Variable flow, constant horsepower hydraulic system provides independent and combined operation of all functions. Load-sensing adjusts hydraulic flow and pressure to individual function demands. Pump displacement is automatically reduced when controls are returned to neutral.

Main pumps: 2 variable-displacement, axial-piston
 Pressure setting 4620 psi (31 854 kPa)
 (319 kg/cm²)
 Maximum oil flow 2 x 30.4 gpm
 (2 x 115 L/min)

Pilot pump: Gear

Pressure setting 570 psi (3930 kPa)
 (40 kg/cm²)

Maximum oil flow 6.6 gpm (25 L/min)

Steering pump: Gear

Pressure setting 1778 psi (12 258 kPa)
 (125 kg/cm²)

Maximum oil flow 4.8 gpm (18.0 L/min)

Control valves: nine spool valves

System relief valve operating pressure:

Travel 4620 psi (31 860 kPa) (325 kg/cm²)

Front end . 4050 psi (27 950 kPa) (285 kg/cm²)

Circuit relief valves:

Boom 4275 psi (29 420 kPa) (300 kg/cm²)

Arm 4275 psi (29 420 kPa) (300 kg/cm²)

Bucket 4770 psi (32 888 kPa) (329 kg/cm²)

Stabilizers . 4050 psi (27 950 kPa) (285 kg/cm²)

Auxiliary ... 4275 psi (29 475 kPa) (295 kg/cm²)

Crossover relief valves:

Travel 4900 psi (33 830 kPa) (345 kg/cm²)

Swing 3340 psi (23 050 kPa) (235 kg/cm²)

Cylinders:	Bore		Rod Diameter		Stroke	
	In.	(mm)	In.	(mm)	In.	(mm)
Boom (2)	3.7	95	2.8	70	42.7	1085
Arm	4.1	105	3.0	75	46.3	1175
Bucket	3.7	95	2.6	65	36.8	935
Stabilizer	4.3	110	2.8	70	14.2	360
Steering	2.2	55	1.0	25	8.5	217
Blade	3.9	100	2.4	60	6.7	170
Axle lock	3.5	90	3.5	90	4.5	115

Arm cylinder has a built-in hydraulic cushion at each end of the stroke. Boom and bucket cylinders have a cushion on the rod end.

Swing Mechanism

Swing speed 0 to 12.5 rpm

Swing lock Manual for transporting

Turntable bearing Single-row, shear-type ball bearing with induction-hardened, lubricated internal gear and pinion, 500-hour lube interval

Wheeled Undercarriage:

The undercarriage is available with a blade or (2) stabilizers. The frame is an all-welded, stress-relieved structure.

Drive system two speed-four wheel drive
Travel motor ... variable displacement, axial piston motor with hydraulic retarding valve for preventing overspeeding when traveling downhill.
Transmission ... Constant mesh with and high and low speed range

Travel speeds:

Low speed range 0 to 6.8 mph
(0 to 11.0 km/h)
(forward and reverse)

High speed range 0 to 21.4 mph
(0 to 34.5 km/h)
(forward)

Maximum traction force—

high 3770 lb (17 kN)(1710 kg)
low 13.095 lb (58 kN) (5940 kg)

Gradability 50 percent (30 degrees)

Steering System:

Full hydraulic power steering using two steering cylinders. Provides manual steering without engine power.

Bore 2.2 in. (55 mm)
Rod diameter 1 in. (25 mm)
Stroke 8.5 in. (217 mm)

Brakes:

Service ... Air over hydraulic brakes acting at each (foot pedal or switch) wheel—internal-expanding shoe type

Parking (switch) Spring actuated, air-released, internal-expanding shoe type, acting on horizontal drive shaft

NOTE: Applying brakes with switch also locks oscillating axle.

Axles:

Front Oscillating axle with locking hydraulic cylinders; 14.0 total oscillation

Rear Fixed to frame

Tires: (Traction type tread pattern)

9.00—20.0 x 12 PR, duals

18.00—19.5 x 18 PR, singles

Stabilizers:

Each stabilizer cylinder is fitted with a pilot-operated check valve for positive locking. Left and right stabilizers can be operated independently.

05T;115 M64 280788

DRAIN AND REFILL CAPACITIES

Item	Metric	U.S.
Fuel tank	250 L	66 gal
Cooling system	21 L	22 qts
Engine crankcase (including filter)	13 L	14 qt
Hydraulic system	133 L	35 gal
Hydraulic reservoir	72 L	19 gal
Swing bearing gear	9 kg	20 lb
Swing gear reduction	3.2 L	3.4 qt
Transmission	5.0 L	5.3 qt
Front axle case	6.0 L	6.4 qt
Wheel gear reduction—each	1.5 L	1.6 qt
Rear axle case	8.5 L	9.0 qt
Brake reservoir8 L	.85 qt

05T;115 M65. 241088

Section 01 WHEELS

CONTENTS

Page

GROUP 0110 — POWER WHEELS AND FASTENINGS

Service Equipment And Tools	0110-1
Specifications	0110-1
Wheel	
Remove and Install	0110-2
Tire	
Remove and Install	0110-3

TX,0100 CC3 170589

SERVICE EQUIPMENT AND TOOLS

NOTE: Order tools from your SERVICE-GARD™ Catalog. Some tools may be available from a local supplier.

Name	Use
10-Ton Shop Stand	To support unit while removing and installing wheels.
Wheel and Axle Lift	To remove and install wheels.

TX,0110 CC1 021288

SPECIFICATIONS

Item	Measurement	Specification
Wheel Lug Nuts	Torque	441—541 N·m (325—399 lb-ft)

TX,0110 CC2 021288

REMOVE AND INSTALL WHEEL

1. Raise machine and place 10-ton shop stands under frame.

⚠ CAUTION: Wheel and tire are heavy. Use a suitable lifting device.

2. Place wheel lift under wheel. Fasten safety chain around upper part of tire.

NOTE: Right side wheel lug nuts have right hand thread; left side wheel lug nuts have left hand thread.

3. Remove lug nuts (A) to remove wheel.
4. Clean mounting surface on wheel and axle.
5. Install wheel assembly.

For dual wheel installations only, align cutouts (A) in wheels for air chuck access.

Tighten lug nuts to 441—541 N·m (325—399 lb-ft).

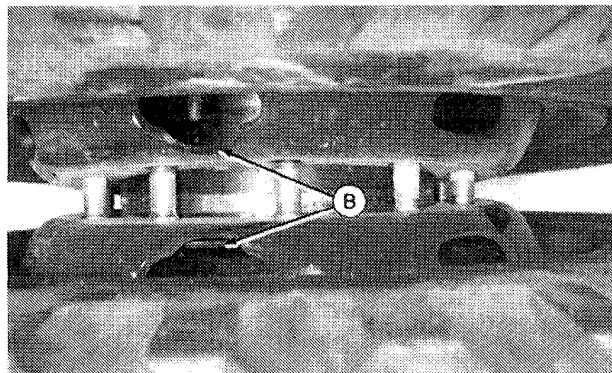
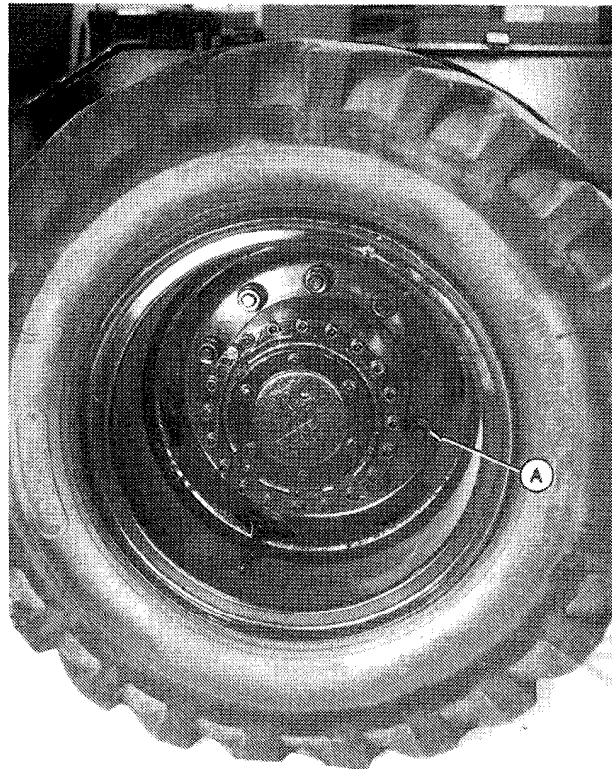

1AG;T6985BW, T6985MG TX,0110 CC3 020589

REMOVE AND INSTALL TIRE

1. The tire can be removed without removing the wheel from the machine. See the John Deere Off-The-Road Tire Maintenance Manual to remove the tire from the wheel.

 **CAUTION: Failure to follow proper procedures when demounting a tire from a wheel or rim can produce an explosion which may result in serious bodily injury. DO NOT attempt to demount a tire unless you have the proper equipment and experience to perform the job safely. Have it done by a qualified tire repair service.**

2. Always completely deflate the tire by removing valve core from valve before attempting any demounting operation. Check the valve stem by running a probe through it to make sure the valve stem is not plugged.

 **CAUTION: Failure to follow proper procedures when mounting a tire on a wheel or rim, can produce an explosion which may result in serious bodily injury. DO NOT attempt to mount a tire unless you have the proper equipment and experience to perform the job safely. Have it done by a qualified tire repair service.**

NOTE: See the John Deere Off-The-Road Tire Maintenance Manual to mount the tire on the wheel.

3. To prevent slipping of the wheel under load, the inside and outside of wheel must be free of paint, rust, oil, grease, dirt or other foreign material before installation.

4. Install valve stem in rim base and tighten valve core housing finger tight.

 **CAUTION: Serious bodily injury can occur from explosion when mounting and inflating tires if safe procedures are not followed.**

5. Before mounting tire on rim, add soap lubricant to bead of tire.

Power Wheels And Fastenings/Tire

6. Clear the area of all persons.

7. Turn tire so valve stem (B) is pointing down. Use a pressure regulating valve (A) with clip-on chuck and extension hose long enough to allow you to stand to one side and NOT in front of tire while inflating.

8. Use only recommended air pressure. Pressure over this limit can cause an explosion.

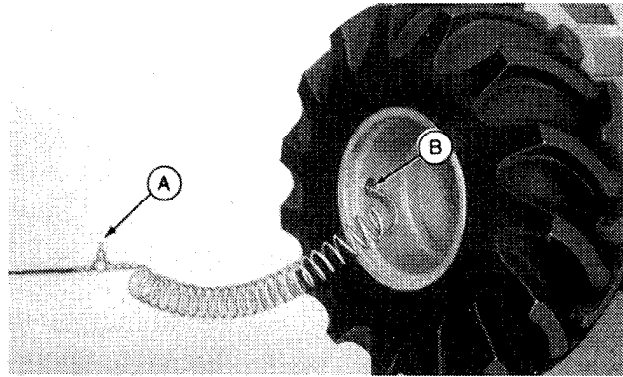

1AG;T6075AD TX,0110 CC5 011288



Suggest:

If the above button click is invalid.

Please download this document

first, and then click the above link

to download the complete manual.

Thank you so much for reading

Section 02

AXLES AND SUSPENSION SYSTEMS (TRAVEL)

CONTENTS

	Page		Page
GROUP 0200 — REMOVAL AND INSTALLATION		GROUP 0250 — AXLE SHAFT, BEARINGS, AND REDUCTION GEARS	
Service Equipment And Tools	0200-1	Service Equipment And Tools	0250-1
Specifications	0200-1	Other Materials	0250-1
Front Axle		Specifications	0250-2
Remove and Install	0200-2	Tow Excavator	0250-3
Front Axle Equalizer Beam		Hub Reduction	
Remove and Install	0200-3	Disassemble	0250-4
Rear Axle		Assemble	0250-7
Remove and Install	0200-4	Knuckle	
GROUP 0210 — DIFFERENTIAL OR BEVEL DRIVE		Disassemble	0250-12
Service Equipment And Tools	0210-1	Assemble	0250-16
Other Materials	0210-1	Front Axle Housing	
Specifications	0210-2	Disassemble and Assemble	0250-22
Front Differential		Rear Axle Housing	
Removal and Install	0210-3	Disassemble and Assemble	0250-25
Rear Differential		Adjust Wheel Toe-In	0250-27
Remove and Install	0210-6	Adjust Steering Stop	0250-28
Differential			
Disassemble	0210-10		
Assemble	0210-14		
GROUP 0225 — INPUT DRIVE SHAFTS AND U-JOINTS			
Other Materials	0225-1		
Specifications	0225-1		
Drive Shaft			
Remove and Install Front	0225-1		
Remove and Install Rear	0225-1		
Disassemble and Assemble Rear	0225-2		
Disassemble and Assemble Front	0225-3		

<https://www.ebooklibonline.com>

Hello dear friend!

Thank you very much for reading.

Enter the link into your browser.

The full manual is available for immediate download.

<https://www.ebooklibonline.com>