

430 and 530 Round Balers



JOHN DEERE

TECHNICAL MANUAL

430 and 530
Round Balers

TM1276 (01SEP86) English

John Deere Ottumwa Works
TM1276 (01SEP86)

LITHO IN U.S.A.
ENGLISH



430 and 530 ROUND BALERS Technical Manual TM-1276 (Sep-86)

SECTION AND GROUP CONTENTS

SECTION 10—GENERAL

- Group 05—Safety
- Group 10—Specifications
- Group 15—General Information
- Group 20—Lubrication

SECTION 20—DRIVE TRAIN

- Group 05—General Information
- Group 10—PTO Hookup
- Group 15—Gear Case and Input Shaft
- Group 20—Roll Drives

SECTION 30—HYDRAULICS

- Group 00—Special Equipment
- Group 05—General Information, Diagnosis,
and Tests
- Group 10—Hydraulic System
- Group 15—Cylinders
- Group 20—Single Spool Valve

SECTION 40—TWINE MECHANISM

- Group 05—Automatic Twine Wrap System
- Group 10—Replace and Adjust Components

SECTION 50—ELECTRICAL

- Group 00—Special Tools
- Group 05—General
- Group 10—Diagnosing Electrical Malfunctions
- Group 15—Electrical Adjustments
- Group 20—Check Electrical Functions

SECTION 60—PICKUP

- Group 05—Diagnosing Pickup Malfunctions
- Group 10—Repair and Replace Components
- Group 15—Remove Pickup
- Group 20—Disassemble Pickup
- Group 25—Pickup Adjustments

SECTION 70—MISCELLANEOUS

- Group 05—Wheel Hub
- Group 10—Converging Wheel
- Group 15—Tension Arm
- Group 20—Remove Gate
- Group 25—Remove and Install Tongue

All information, illustrations and specifications contained in this technical manual are based on the latest information available at the time of publication. The right is reserved to make changes at any time without notice.

COPYRIGHT® 1986
DEERE & COMPANY
Moline, Illinois
All rights reserved
A JOHN DEERE ILLUSTRATION

E01;0000 0 280886

INTRODUCTION

This technical manual is part of a twin concept of service:

FOS Manuals — for reference

Technical Manuals — for actual service

The two kinds of manuals work as a team to give you both the general background and technical details of shop service.

Fundamentals of Service (FOS) Manuals cover basic theory of operation, *fundamentals* of trouble shooting, *general* maintenance, and *basic* types of failures and their causes. FOS Manuals are for training new people and for reference by experienced technicians.

Technical Manuals are concise service guides for a *specific* machine. Technical Manuals are on-the-job guides containing only the vital information needed by an experienced technician.

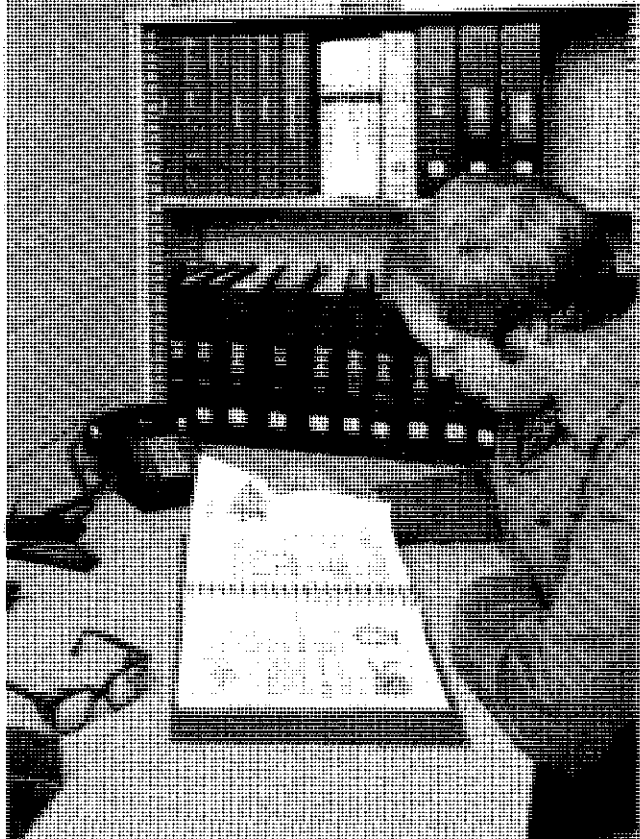

3FA; RW5559 E01;0000 ZB 112282

FEATURES OF THIS TECHNICAL MANUAL

- John Deere ILLUSTRATION format emphasizing more detailed pictures and fewer words.
- Instructions and illustrations grouped together in easy-to-use modules.
- Removal and installation groups preceding some repair groups. These groups show how to remove and install components from the machine rather than from major components. They also show how to acquire access to major components of a machine.
- *Exploded views showing parts relationship.*

This technical manual was planned and written for you—an experienced technician. Keep it in a permanent binder in the shop where it is handy. Refer to it whenever in doubt about correct service procedures or specifications.

Using the technical manual as a guide will reduce error and costly delay. It will also assure you the best in finished service work.

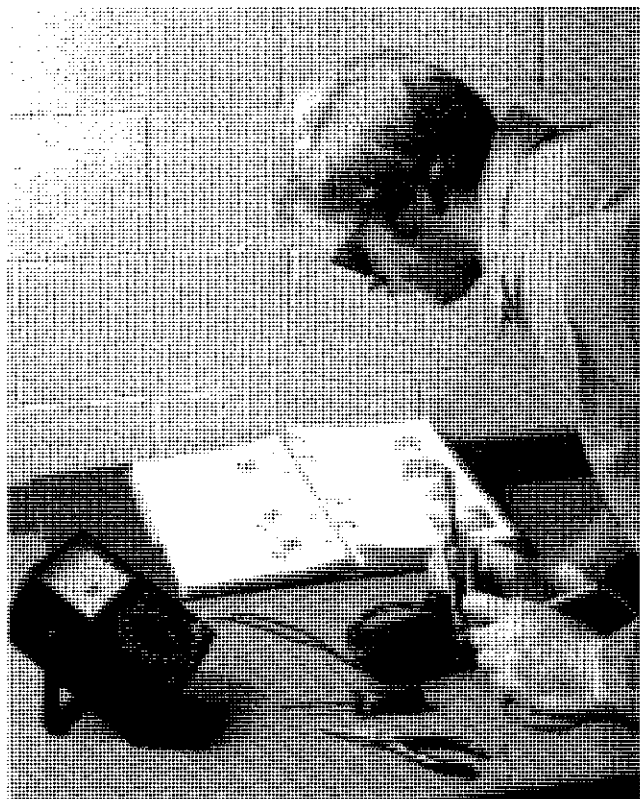

3FA;RW5560 E01;0000 ZC 221182

<https://www.ebooklibonline.com>

Hello dear friend!

Thank you very much for reading.

Enter the link into your browser.

The full manual is available for immediate download.

<https://www.ebooklibonline.com>

Section 10 GENERAL

CONTENTS

	Page
Group 05 - SAFETY	10-05-01
Group 10 - SPECIFICATIONS	10-10-01
Torque Chart	10-10-03
Group 15 - GENERAL	
Description	10-15-01
Tractor Requirements	10-15-01
GROUP 20 - LUBRICATION	
Grease	10-20-01
Gear Case Oil	10-20-01
Hydraulic Oil	10-20-02
Alternative Lubricants	10-20-02

OBSERVE SAFETY RULES

 **CAUTION:** This safety alert symbol identifies important safety messages in this manual and on the machine. When you see this symbol, be alert to the possibility of personal injury and carefully read the message that follows.

Avoid loose clothing that can catch in moving parts and put you out of work.

Wear your safety glasses while on the job.

Avoid working on equipment with the engine running. If it is necessary to make checks with the engine running, ALWAYS USE TWO PEOPLE—with the operator, at the controls, able to see the person doing the checking. Also, put the transmission in neutral, set the brake, and apply safety locks provided. KEEP HANDS AWAY FROM MOVING PARTS.

Don't attempt to check belt tension while the engine is running.



T27999

3FA;T27999 E01;1005 D 221182

OBSERVE "IMPORTANT" MESSAGES

Messages labeled "Important" will appear in this manual and/or on the machine to provide specific instructions for performing adjustments, services, etc. If these instructions are not followed, it could result in damage to the machine.

3FA; E01;1005 E 221182

NOTES

The word *NOTE* is followed by a statement that identifies a qualification or exception to a previous statement. A "NOTE" may also identify nice-to-know information pertinent to, but not directly related to the previous statement.

0A9; E05;1005 ZG 140682

FOLLOW SAFE PRACTICES

Wear safety equipment.

Wear fairly tight clothing.

Keep the service area clean and dry. Wet or oily floors are slippery. Wet spots can be dangerous when working with electrical equipment.

Make sure the service area is adequately vented.

Periodically check the shop exhaust system for leakage. Engine exhaust gas is dangerous.

Be sure all electrical outlets and tools are properly grounded.

Use adequate light for the job at hand.

Use lifting equipment and safety stands which have adequate strength for the job being performed.

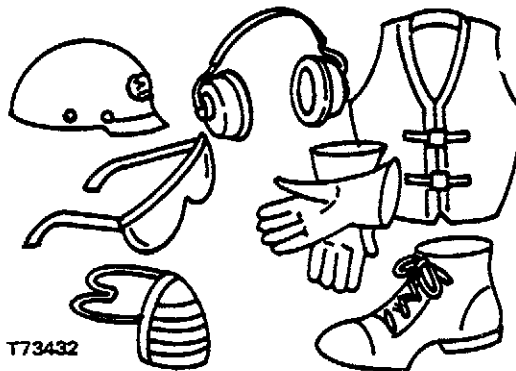

3FA;T73432 E01;1005 F 221182

Position gate lock valve to locked position before working on or around baler with gate in raised position.

To avoid injury stay clear of gate while it is being raised and lowered.

Be sure bystanders are clear before operating gate.

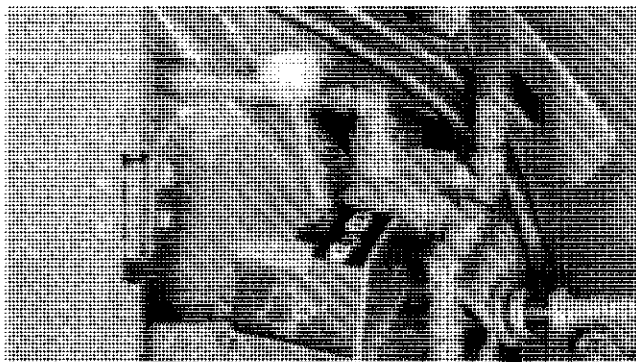

3FA;E21639 E01;1005 G 221182

AVOID HIGH PRESSURE-FLUIDS

Escaping fluid under pressure can penetrate the skin causing serious injury. Relieve pressure before disconnecting hydraulic or other lines. Tighten all connections before applying pressure. Keep hands and body away from pinholes and nozzles which eject fluids under high pressure. Use a piece of cardboard or paper to search for leaks. Do not use your hand.

If ANY fluid is injected into the skin, it must be surgically removed within a few hours by a doctor familiar with this type injury or gangrene may result.

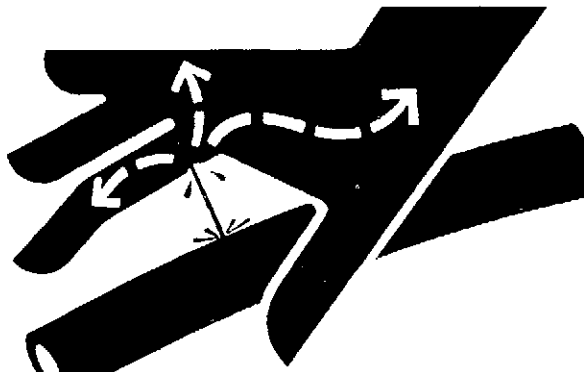

3FA;X9811 E01;1005 A 221182

AVOID FIRE HAZARDS

Be prepared if an accident or fire should occur. Know where the first aid kit and the fire extinguishers are located and know how to use them.

Don't smoke while refueling or handling highly flammable material.

Don't use open pans of gasoline or diesel fuel for cleaning parts. Use good commercial, nonflammable solvents.

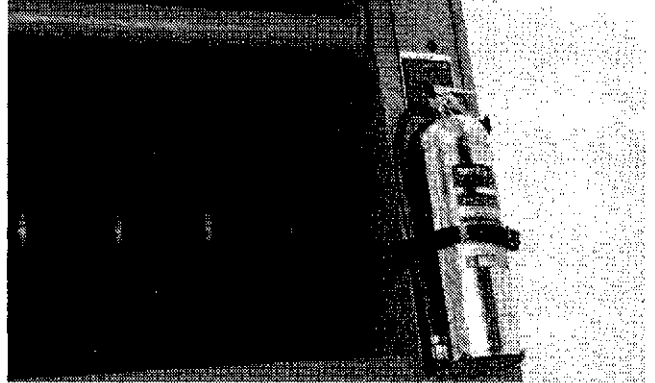

3FA/E21601 E01:1005 H 310183

SERVICE TIRES SAFELY

Failure to follow proper procedures when mounting a tire on a wheel or rim can produce an explosion which may result in serious injury or death. Do not attempt to mount a tire unless you have the proper equipment and experience to perform the job. Have it done by your John Deere dealer or a qualified tire repair service.

When sealing tire beads on rims, never exceed 35 psi (241 kPa) (2.4 bar) or maximum inflation pressures specified by tire manufacturers for mounting tires. Inflation beyond this maximum pressure may break the bead, or even the rim, with dangerous explosive force. If both beads are not seated when the maximum recommended pressure is reached, deflate, reposition tire, relubricate bead and reinflate.

Detailed tire mounting instructions, including necessary safety precautions, are contained in John Deere Fundamentals of Service (FOS) Manual 55, Tires and Tracks, available through your John Deere dealer. Such information is also available from the Rubber Manufacturers Association and from tire manufacturers.

- A—Use a Safety Cage if Available.
- B—Do Not Stand Over Tire. Use a Clip-on Chuck and Extension Hose.

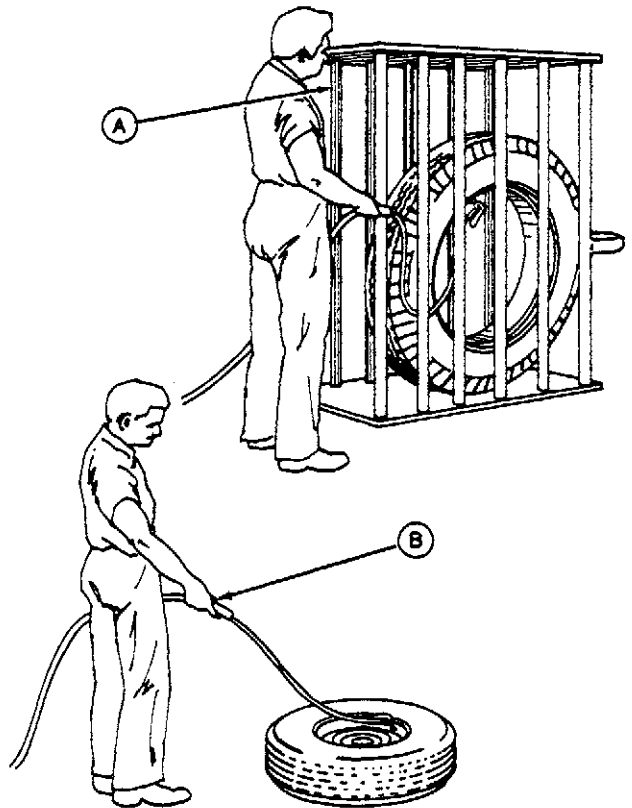

A86:TS0123 053;TSAFT A 091283

DO NOT MODIFY MACHINE

Unauthorized modifications to the machine may impair the function and/or safety and affect machine life.

3FA: E01:1005 J 221182

SPECIFICATIONS

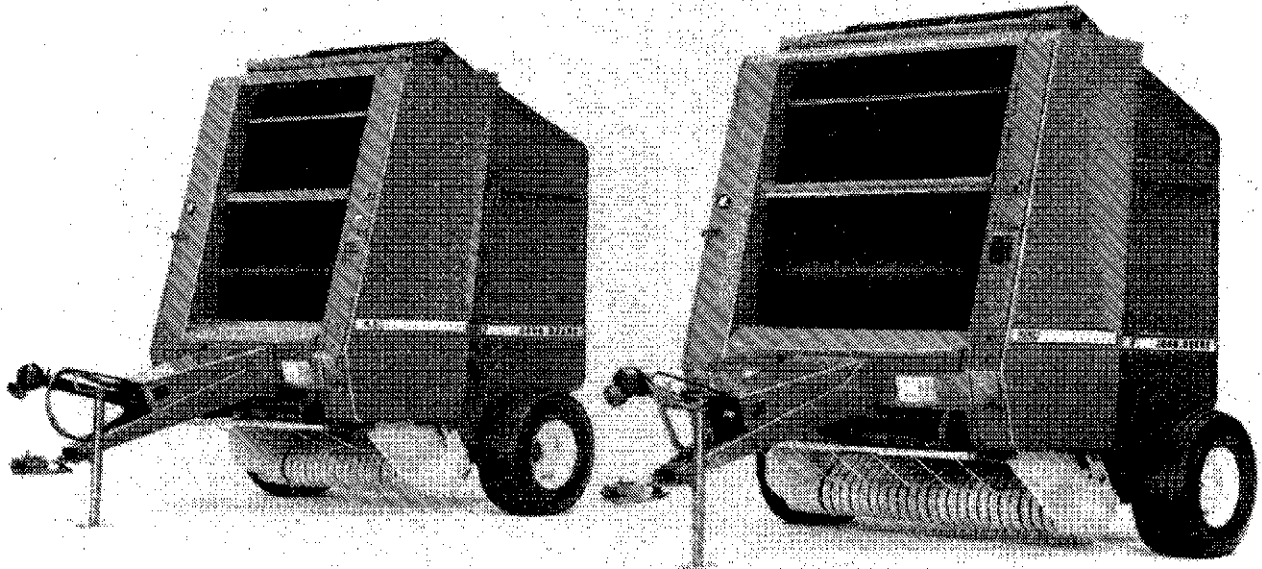

BALE:

Diameter	1000 mm up to 1829 mm (39 in. up to 72 in.)
Width	
430	1170 mm (46 in.)
530	1565 mm (61.6 in.)
Weight	
430	630 kg (1400 lbs)
	(Depending on crop and moisture content)
530	833 kg (1850 lbs)
	(Depending on crop and moisture content)

BALER:

Weight	
430	1773 kg (3940 lbs)
530	1958 kg (4350 lbs)
Length, gate closed	3710 mm (146 in.)
Length, gate open	4750 mm (187 in.)
Height, gate closed	2810 mm (110 in.)
Height, gate open	3640 mm (143 in.)
Width	
430	2450 mm (96 in.)
530	2840 mm (112 in.)

Specifications

PICKUP:

Width (inside)	
430	1170 mm (46 in.)
530	1565 mm (61.6 in.)
Width (on flare)	
430	1410 mm (55.5 in.)
530	1810 mm (71 in.)
Width (between outer teeth)	
430	1120 mm (44 in.)
530	1520 mm (60 in.)
Bars	4
Number of teeth	
430	72
530	96
Tooth spacing	66 mm (2.6 in.)
Stripper diameter	255 mm (10 in.)

FORMING BELTS:

Number	
430	6
530	8
Type	3-ply fabric, diamond tread
Length	
430	2 - 13 330 mm (525 in.) 4 - 13 490 mm (531 in.)
530	4 - 13 330 mm (525 in.) 4 - 13 490 mm (531 in.)

TWINE WRAP:

Control	Self-activating, automatic to preset bale size
Type	Hydraulic, self-contained
Spacing	Adjustable, infinitely variable

OPERATOR'S CONSOLE:

Bale forming monitors	Dial indicators
Near-full bale indicator	Flashing yellow light
Auto-wrap indicator	Solid yellow light
Oversize bale protection	Red light with audible warning
Gate closed	Green light
Tire size	11L x 14, 6-ply rating 31.5 x 13.5 option
PTO shaft speed	540 or with 1000 rpm conversion
Drive protection	Slip clutch
Tractor recommended	430 - 50 hp (37.5 kW) minimum 530 - 70 hp (52.5 kW) minimum

(Specifications and design are subject to change without notice.)

3FA; E01;1010 J 120384

BOLT TORQUE CHARTS

The tables shown below give correct torque values for various bolts and cap screws. Check bolts periodically, using bolt torque chart as a guide.

U.S. MEASUREMENT

Bolt Diameter "A"	Bolt Torque in Lbs-Ft (N·m)					
	SAE 2	Used	SAE 5	(N·m)	SAE 8	(N·m)
1/4"	Not Used	14	(10)	19	(14)	
5/16"	Not Used	27	(20)	41	(30)	
3/8"	23	(31)	35	(47)	50	(68)
7/16"	35	(47)	55	(75)	80	(108)
1/2"	55	(75)	85	(115)	120	(163)
9/16"	75	(102)	130	(176)	175	(237)
5/8"	105	(142)	170	(231)	240	(325)
3/4"	185	(251)	300	(407)	425	(576)
7/8"	160	(217)	445	(603)	685	(929)
1"	250	(339)	670	(910)	1030	(1396)
1-1/4"	330	(450)	910	(1235)	1460	(1979)

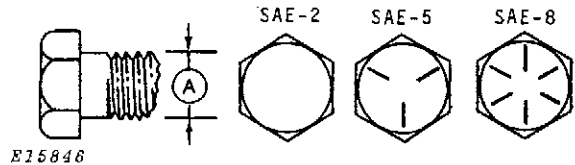

Replace hardware with the same strength bolt.

METRIC MEASUREMENT

Bolt Diameter "A"	Bolt Torque in Lbs-Ft (N·m)			
	8.8	10.9	10.9	10.9
5 mm	5	(6)	7	(9)
6 mm	9	(11)	13	(17)
8 mm	20	(28)	30	(40)
10 mm	40	(55)	59	(80)
12 mm	70	(95)	103	(140)
16 mm	173	(235)	258	(350)
20 mm	350	(475)	498	(675)
24 mm	608	(825)	863	(1170)
30 mm	1201	(1630)	1712	(2320)

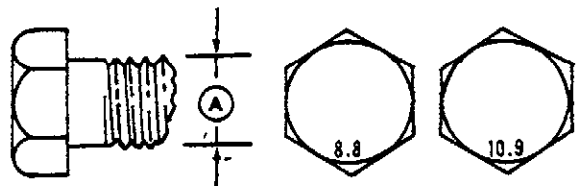

NOTE: Bolts having lock nuts should be torqued to approximately 65% of amounts shown in above chart.

DESCRIPTION

The 430 and 530 Round Balers consist of a main frame and wheels, pickup, belts, gate and bale wrapping system.

Power is provided from a 540 rpm tractor PTO. Both balers can be converted from 540 to 1000 rpm.

The tractor PTO drives a hydraulic pump on the baler which provides the hydraulic pressure to operate the twine cylinder.

Two sets of hydraulic cylinders operate from the tractor hydraulic system. One set raises and lowers the gate. The other set raises and lowers the center arm and works in conjunction with springs to provide bale tension.

3FA; E01;1015 E 221182

TRACTOR HOOKUP

IMPORTANT: Unequal angles occur during a turn if the tractor drawbar is not set to the correct length. Turning with unequal angles while operating the machine will cause noise and vibration and premature failure of powerline components.

Correct tractor drawbar hookup dimensions are:

(540 rpm)	(1000 rpm)
A—356 mm (14 in.)	406 mm (16 in.)
B—152-305 mm (6-12 in.)	152-305 mm (6-12 in.)
C—330-432 mm (13-17 in.)	330-432 mm (13-17 in.)

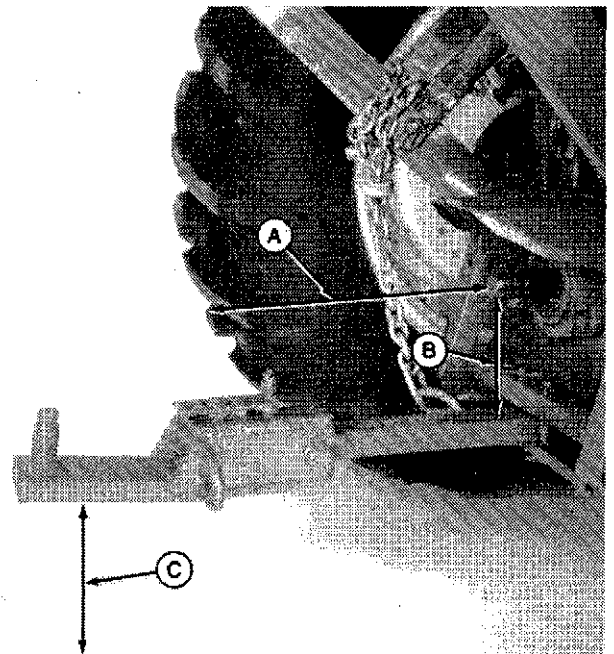

3FA;E22116 E01;1015 F 221182

⚠ CAUTION: Do not clean, lubricate, or adjust baler while it is in motion.

IMPORTANT: The lubrication period recommended is based on normal conditions. Severe or unusual conditions may require more frequent lubrication or oil changes.

See operator's manual for detailed instructions.

Clean grease fittings before using grease gun. Replace any lost or broken fittings immediately. If a new fitting fails to take grease, remove it and check for failure of adjoining parts.

3FA; E01;1020 G 310183

GENERAL PURPOSE GREASE

Depending upon the expected air temperature range during the service interval, use grease as shown on the adjoining temperature chart.

John Deere Multipurpose Grease is recommended. If other greases are used, use:

- SAE Multipurpose Grease
- SAE Multipurpose Grease containing 3 to 5 per cent molybdenum disulfide.

At temperatures below -30°C (-22°F), use arctic greases such as those meeting Military Specification MIL-G-10924C.

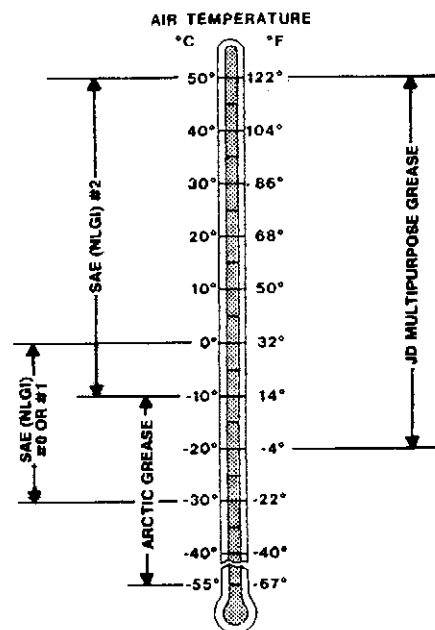

3FA;X9326 E01;1020 H 310183

GEAR CASE OIL

Depending upon the expected air temperature range during the drain interval, use oil viscosity shown in the temperature chart.

John Deere API GL-5 Gear oil is recommended. If other oils are used, they must be oils meeting the following requirements:

- API Service Classification GL-5
- Military Specification MIL-L-2105B
- Military Specification MIL-L-2105C

At temperatures below -35°C (-31°F), use arctic oils such as those meeting Military Specification MIL-L-10324A.

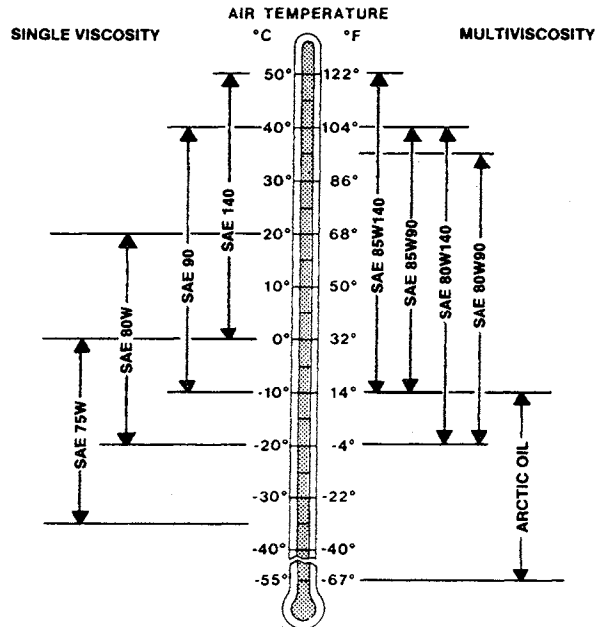

3FA;X9322 E01;1020 I 310183

HYDRAULIC OIL

Use John Deere All-Weather Hydrostatic Fluid or Type "F" automatic transmission fluid.

3FA; E01;1020 J 221182

ALTERNATIVE LUBRICANTS

Conditions in certain geographical areas may require special lubricants and lubrication practices which do not appear in this operator's manual. If you have any questions, consult your John Deere dealer to obtain the latest information and recommendations.

3FA; E01;1020 K 221182

Section 20 DRIVE TRAIN

CONTENTS

	Page		Page
GROUP 05—GENERAL INFORMATION		GROUP 20—ROLLS AND ROLL DRIVE	
Drive Train	20-05-1	General Information	20-20-1
Operating RPM	20-05-1	Remove Upper Belt Drive Roll	20-20-3
GROUP 10—PTO HOOKUP		Remove Lower Gate Roll	20-20-4
General Information	20-10-1	Remove Lower Rear Gate Roll	20-20-5
Inspect Straightness of PTO Hookup	20-10-1	Adjust Belt Tracking	20-20-6
Remove PTO POWR-GARD®		Replace Top Idler Roll	20-20-6
Hookup	20-10-1	Remove Center and Rear Tension	
Disassemble PTO POWR-GARD		Arm Rolls	20-20-7
Hookup	20-10-2	Remove Starter Roll	20-20-8
Assemble PTO POWR-GARD		Remove Lower Belt Drive Roll	20-20-10
Hookup	20-10-5	Roll to Side Sheet Spacing	20-20-11
Assemble Quik-Detach Hookup	20-10-5	Remove Belt Staggering Roll	20-20-12
GROUP 15—GEAR CASE AND INPUT SHAFT		Remove Front Idler Roll	20-20-12
Specifications	20-15-1	Remove Front Tension Arm Idler Roll	20-20-13
Special Tools	20-15-1	Remove Top Arm Roll	20-20-13
Materials	20-15-1	Remove Upper Rear Gate Roll	20-20-14
General Information	20-15-2	Replace Bearings with Cast	
Remove Gear Case	20-15-2	Housings	20-20-14
Disassemble Superior Gear Case	20-15-3	Replace Bearings with Steel	
Inspect Gear Case Parts	20-15-6	Flangettes	20-20-15
Assemble Superior Gear Case	20-15-6	Replace Bearings in Roll	20-20-15
Disassemble Comer Gear Case	20-15-8	Adjust Roll Scraper	20-20-16
Inspect Gear Case Parts	20-15-12	Adjust Chains	20-20-16
Install Input Shaft	20-15-13		
Install Output Shaft	20-15-15		
Install Gear Case and Slip Clutch	20-15-17		
Adjust Slip Clutch	20-15-21		
Slip Clutch Torque Values	20-15-21		
Convert Baler to 1000 RPM	20-15-22		

DRIVE TRAIN

The baler is driven from the tractor PTO shaft through universal joints to the input shaft and then to the gear case. The drives are protected by a slip clutch attached to the input shaft.

From the gear case, power is transmitted to the left-hand side of the baler to drive the upper and lower drive rolls and the starter roll. The starter roll drives the pickup. The twine-wrap hydraulic pump is driven off the lower drive roll.

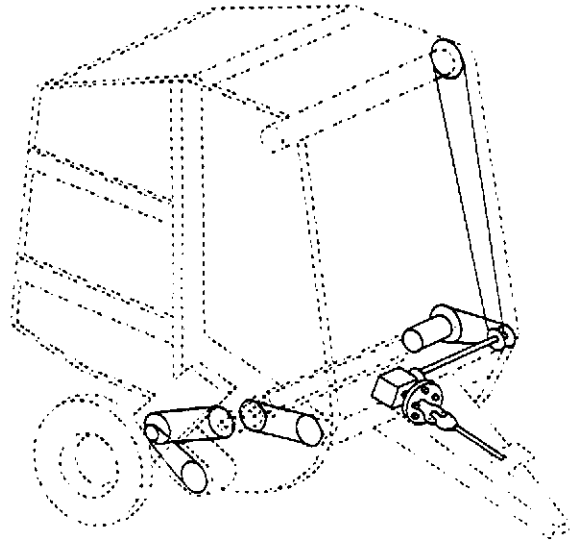

0FA;E22117 E01:2005 C 231182

OPERATING RPM

The 430 and 530 Balers are shipped from the factory equipped for 540 rpm operation only. Both balers can be field converted to 1000 rpm.

0FA; E01:2005 D 231182

GENERAL INFORMATION

PTO operating speed of tractor and baler must be the same. The front half of the hookup (A) has six splines for 540 rpm PTO and twenty-one splines for 1000 rpm PTO operation.

CAUTION: Never connect a 540 rpm baler to a 1000 rpm tractor.

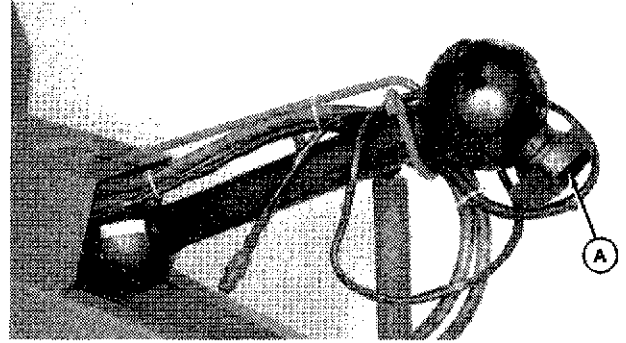

OFA/E21814 E01/2010 E 231182

INSPECT STRAIGHTNESS OF PTO HOOKUP

1. Clean rust, dirt and paint from cap holders.
2. Replace spider and bearing assembly, if worn.

CAUTION: Do not start tractor while inspecting shaft for straightness.

Check yoke and tube, yoke and shaft for straightness using dial indicator (A). Hookup to tractor and baler TIR should be (0.90 mm) 0.35-inch maximum in middle of hookup. If hookup is out of tolerance, straighten or replace.

4. Check shaft for roughness, nicks or pitting of surface.
5. Replace compression springs if cracked or rusted.
6. Replace nylon locking bearings if worn.

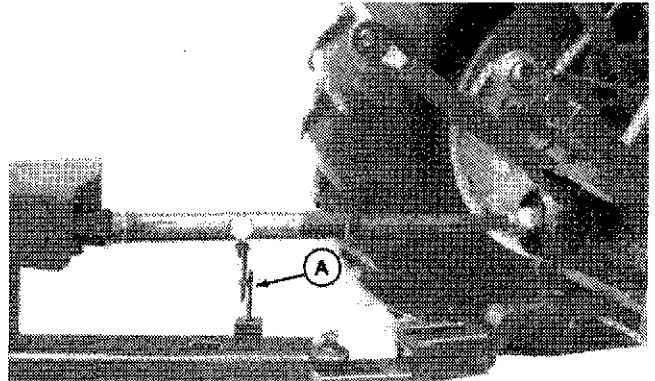

OFA/E21509 E01/2010 F 231182

REMOVE PTO POWR-GARD® HOOKUP

1. Remove nut, bolt, and washer (A) from rear section of hookup (B).
2. Slide rear section off input shaft (C).
3. Separate front section of hookup (D) from rear section of hookup (B) by pulling the sections apart.

A—Nut, Bolt, and Washer
B—Rear Section of Hookup

C—Input Shaft
D—Front Section of Hookup

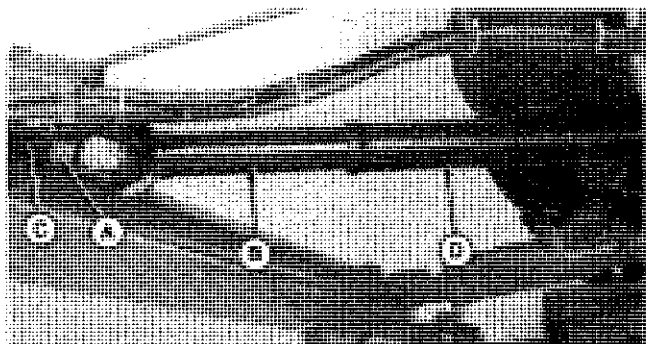

OFA/E22034 E01/2010 G 231182

DISASSEMBLE PTO POWR-GARD HOOKUP

1. Place powershaft front section in vise.
2. Support push collar (A) assembly. Remove snap ring (B).
3. Remove push collar (A) and push-button latch (C).

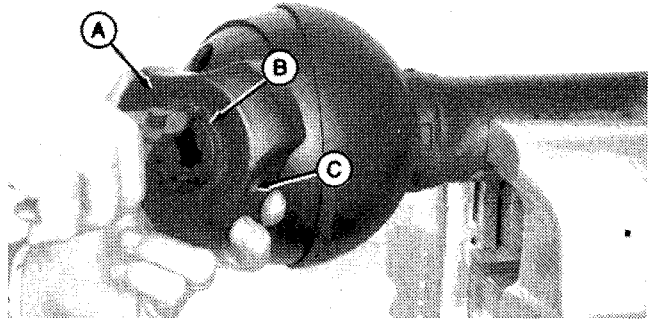

0FA/E22118 E01;2010 H 231182

4. Remove three steel balls (C) from push-button yoke.
5. Remove collar retainer (A) and spring (B).

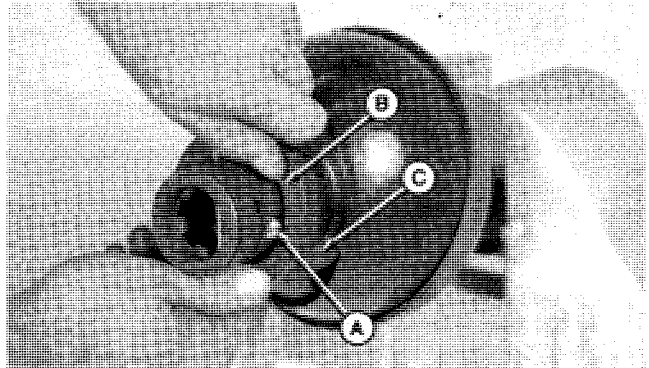

0FA/E18306 E01;2010 I 231182

6. Insert small screwdriver in slot of locking bearing (C). Lift locking bearing up and out of assembly.
7. Remove shield (A) from yoke (B).

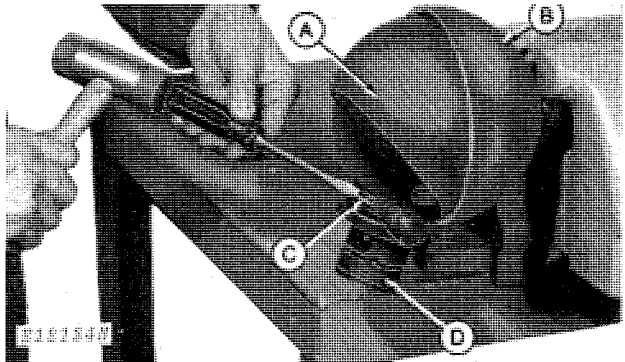

0FA/E12124 E01;2010 J 231182

8. Remove locking bearings (A) from front shield.
9. Remove yoke and shaft assembly (B) from front shield.

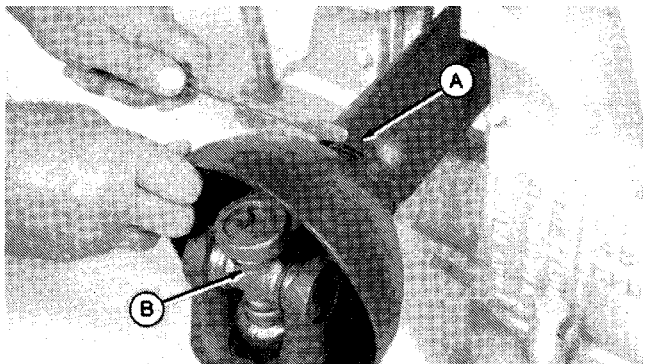

0FA/E18308 E01;2010 K 231182

PTO Hookup

10. Support yoke and shaft assembly in vise. Remove retaining rings (B) from spider and bearing assembly. If retaining rings stick, loosen by tapping with a rubber hammer.

Note position of grease fitting (A) so it can be properly positioned during reassembly.

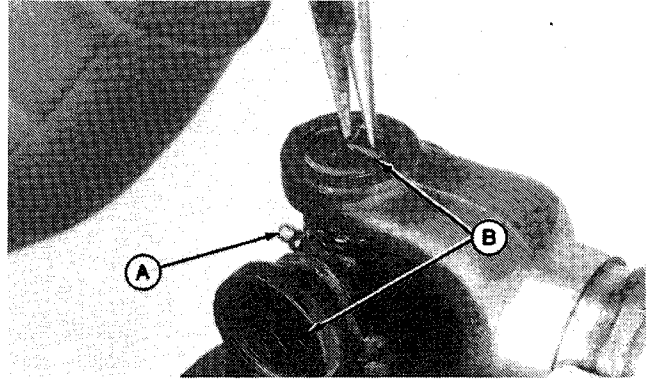

OFA;E18525 E01;2010 L 231182

11. Position joint in an open vise with each ear of one yoke supported by a vise jaw.

12. With a soft hammer or mallet, strike the top ear of the unsupported yoke. This will drive the top bushing outward approximately (9.5 mm) 3/8-inch.

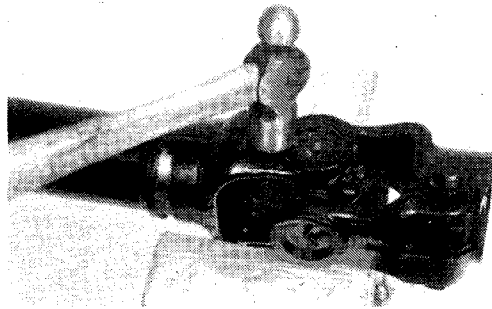

OFA;E19272 E01;2010 ZAO 231182

13. Clamp loosened bearing in vise and drive yoke off.

14. Repeat this procedure for removing bearing directly opposite the one just removed, after which the yoke itself may be removed.

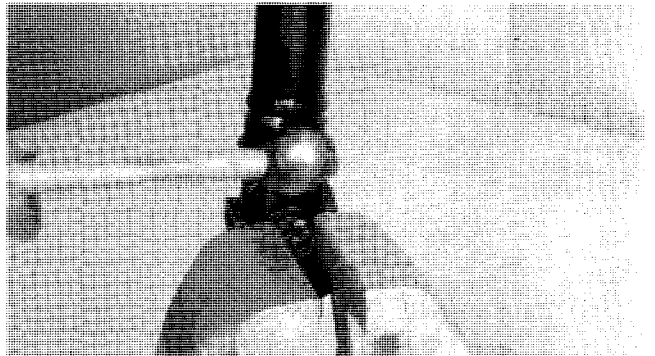

OFA;E19273 E01;2010 ZAP 231182

15. To remove remaining two bushings, support cross as shown making certain that vise jaws are covered with brass protectors. By striking yoke ear, the remaining bushings can be removed by repeating procedure in step 12.



OFA;E19274 E01;2010 ZAQ 231182



Suggest:

If the above button click is invalid.

Please download this document

first, and then click the above link

to download the complete manual.

Thank you so much for reading

PTO Hookup

Remove bearings (A) from rear shield. Remove yoke and shaft (B) from shield.

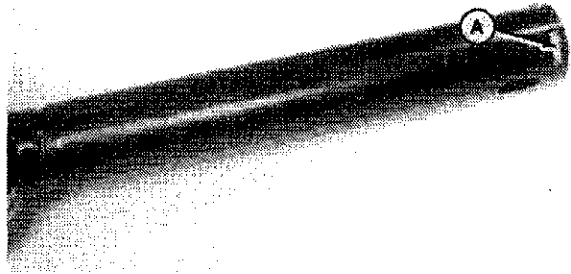

0FA;E23904 E01;;2010 Q 090284

After yoke and shaft have been removed from rear shield, press nylon guide (A) from shield.

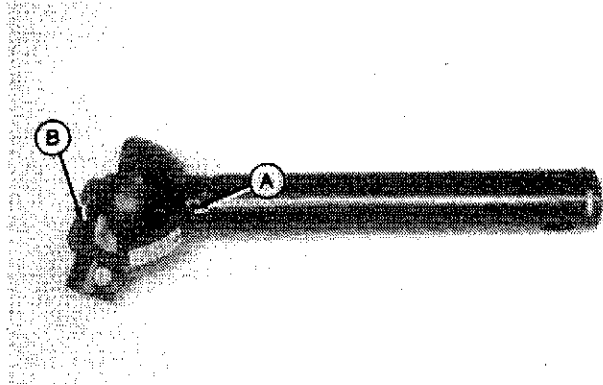

0FA;E23905 E01;;2010 N 090284

<https://www.ebooklibonline.com>

Hello dear friend!

Thank you very much for reading.

Enter the link into your browser.

The full manual is available for immediate download.

<https://www.ebooklibonline.com>