

1. Trim along dashed line.
2. Slide into pocket on Binder Spine.

TYPE 1-4

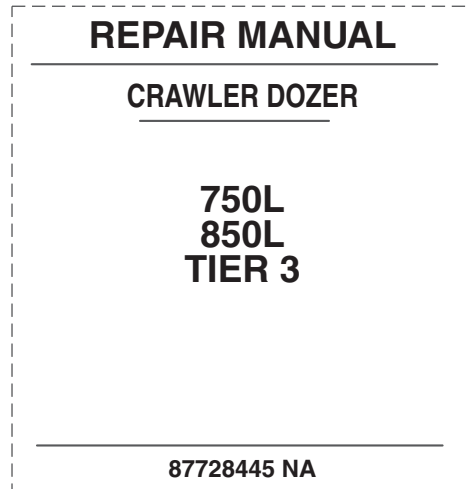

1. Trim along dashed line.
2. Slide into pocket on Binder Spine.

TYPE 1-4

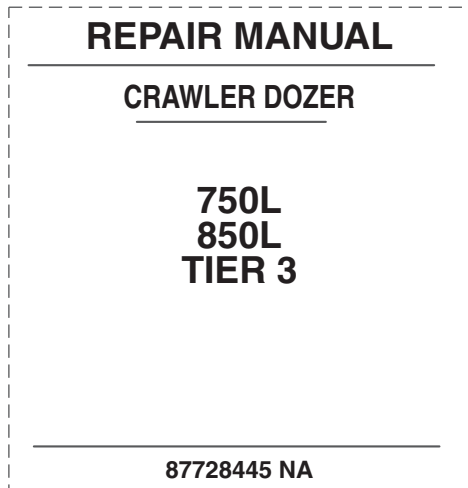

1. Trim along dashed line.
2. Slide into pocket on Binder Spine.

TYPE 1-4

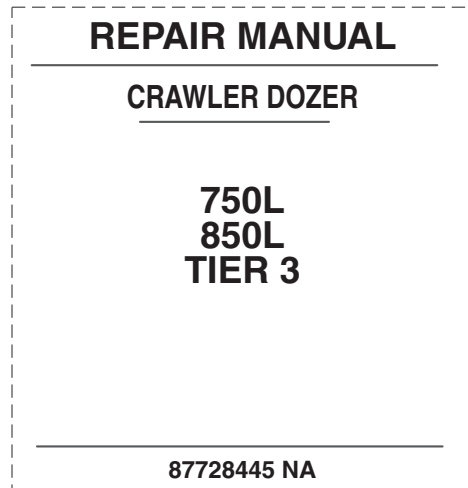

1. Trim along dashed line.
2. Slide into pocket on Binder Spine.

TYPE 1-4



REPAIR MANUAL



750L
850L

Contents

INTRODUCTION

DISTRIBUTION SYSTEMS

A

PRIMARY HYDRAULIC POWER SYSTEM	A.10.A
SECONDARY HYDRAULIC POWER SYSTEM	A.12.A
ELECTRICAL POWER SYSTEM	A.30.A
LIGHTING SYSTEM	A.40.A
FAULT CODES	A.50.A

POWER PRODUCTION

B

ENGINE	B.10.A
FUEL AND INJECTION SYSTEM	B.20.A
AIR INTAKE SYSTEM	B.30.A
ENGINE COOLANT SYSTEM	B.50.A
LUBRICATION SYSTEM	B.60.A
STARTING SYSTEM	B.80.A

POWER TRAIN

C

POWER COUPLING Fixed coupling	C.10.B
TRANSMISSION Hydrostatic	C.20.F

TRAVELLING

D

Final drive	D.15.A
SERVICE BRAKE Hydraulic	D.30.C
PARKING BRAKE Hydraulic	D.32.C
WHEELS AND TRACKS Tracks	D.50.B

BODY AND STRUCTURE

E

USER CONTROLS AND SEAT	E.32.A
USER CONTROLS AND SEAT Operator seat	E.32.C
USER PLATFORM	E.34.A
ENVIRONMENT CONTROL Heating system	E.40.B
ENVIRONMENT CONTROL Air-conditioning system	E.40.C

<https://www.ebooklibonline.com>

Hello dear friend!

Thank you very much for reading.

Enter the link into your browser.

The full manual is available for immediate download.

<https://www.ebooklibonline.com>

ENVIRONMENT CONTROL Heating, ventilation and air-conditioning	E.40.D
SAFETY SECURITY ACCESSORIES Safety	E.50.B
TOOL POSITIONING	G
LIFTING	G.10.A
TILTING	G.20.A
SWINGING	G.40.A
WORKING ARM	H
SINGLE ARM TOOL ATTACHMENT Lift	H.50.B
TOOLS AND COUPLERS	J
DIGGING Non-articulated digging tools	J.20.B
LANDSCAPING Dozer blade	J.40.F



INTRODUCTION

Contents

INTRODUCTION

Basic instructions	3
General specification	7
Conversion factors	11
Hydraulic contamination	13

Basic instructions

Technical Information

This manual has been produced by a new technical information system. This new system is designed to deliver technical information electronically through CDROM and in paper manuals. A coding system called ICE has been developed to link the technical information to other Product Support functions e.g. Warranty.

Technical information is written to support the maintenance and service of the functions or systems on a customers machine. When a customer has a concern on his machine it is usually because a function or system on his machine is not working at all, is not working efficiently, or is not responding correctly to his commands. When you refer to the technical information in this manual to resolve that customers concern, you will find all the information classified using the new ICE coding, according to the functions or systems on that machine. Once you have located the technical information for that function or system then you will find all the mechanical, electrical or hydraulic devices, components, assemblies and sub-assemblies for that function or system. You will also find all the types of information that have been written for that function or system, the technical data (specifications), the functional data (how it works), the diagnostic data (fault codes and troubleshooting) and the service data (remove, install adjust, etc.).

By integrating this new ICE coding into technical information , you will be able to search and retrieve just the right piece of technical information you need to resolve that customers concern on his machine. This is made possible by attaching 3 categories to each piece of technical information during the authoring process.

The first category is the Location, the second category is the Information Type and the third category is the Product:

- LOCATION - is the component or function on the machine, that the piece of technical information is going to describe e.g. Fuel tank.
- INFORMATION TYPE - is the piece of technical information that has been written for a particular component or function on the machine e.g. Capacity would be a type of Technical Data that would describe the amount of fuel held by the Fuel tank.
- PRODUCT - is the model that the piece of technical information is written for.

Every piece of technical information will have those 3 categories attached to it. You will be able to use any combination of those categories to find the right piece of technical information you need to resolve that customers concern on his machine.

That information could be:

- the description of how to remove the cylinder head
- a table of specifications for a hydraulic pump
- a fault code
- a troubleshooting table
- a special tool

How to Use this Manual

This manual is divided into Sections. Each Section is then divided into Chapters. Contents pages are included at the beginning of the manual, then inside every Section and inside every Chapter. An alphabetical Index is included at the end of a Chapter. Page number references are included for every piece of technical information listed in the Chapter Contents or Chapter Index.

Each Chapter is divided into four Information types:

- **(D)** Technical Data (specifications) for all the mechanical, electrical or hydraulic devices, components and, assemblies.
- **(C)** Functional Data (how it works) for all the mechanical, electrical or hydraulic devices, components and assemblies.
- **(G)** Diagnostic Data (fault codes, electrical and hydraulic troubleshooting) for all the mechanical, electrical or hydraulic devices, components and assemblies.

- (F) Service data (remove disassembly, assemble, install) for all the mechanical, electrical or hydraulic devices, components and assemblies.

Sections

Sections are grouped according to the main functions or a systems on the machine. Each Section is identified by a letter A, B, C etc. The amount of Sections included in the manual will depend on the type and function of the machine that the manual is written for. Each Section has a Contents page listed in alphabetic/numeric order. This table illustrates which Sections could be included in a manual for a particular product.

PRODUCT	SECTION										
	A - Distribution Systems										
	B - Power Production										
	C - Power Train										
	D - Travelling										
	E - Body and Structure										
	F - Frame Positioning										
	G - Tool Positioning										
	H - Working Arm										
	J - Tools and Couplers										
	K - Crop Processing										
L - Field Processing											
Tractors	X	X	X	X	X	X	X	X	X	X	
Vehicles with working arms: backhoes, excavators, skid steers,	X	X	X	X	X	X	X	X	X		
Combines, forage harvesters, balers,	X	X	X	X	X	X	X	X	X	X	
Seeding, planting, floating, spraying equipment,	X	X	X	X	X	X	X		X		X
Mounted equipment and tools,					X	X	X		X		

Chapters

Each Chapter is identified by a letter and number combination e.g. Engine B.10.A The first letter is identical to the Section letter i.e. Chapter B.10 is inside Section B, Power Production.

CONTENTS

The Chapter Contents lists all the (D) technical data (specifications), (C) functional data (how it works), (F) service data (remove, install adjust, etc.) and (G) diagnostic data (fault codes and troubleshooting) that have been written in that Chapter for that function or system on the machine.

Contents

	POWER PRODUCTION	
	ENGINE _ 10.A	
TECHNICAL DATA		
ENGINE - General specification (B.10.A - D.40.A.10)		3
FUNCTIONAL DATA		
ENGINE - Dynamic description (B.10.A - C.30.A.10)		4
SERVICE		
ENGINE - Remove (B.10.A - F.10.A.10)		5
DIAGNOSTIC		
ENGINE - Troubleshooting (B.10.A - G.40.A.10)		6

INDEX

The Chapter Index lists in alphabetical order all the types of information (called Information Units) that have been written in that Chapter for that function or system on the machine.

Index

POWER PRODUCTION - B ENGINE	
ENGINE - Dynamic description (B.10.A - C.30.A.10)	4
ENGINE - General specification (B.10.A - D.40.A.10)	3
ENGINE - Remove (B.10.A - F.10.A.10)	5
ENGINE - Troubleshooting (B.10.A - G.40.A.10)	6

Information Units and Information Search

Each chapter is composed of information units. Each information unit has the ICE code shown in parentheses which indicates the function and the type of information written in that information unit. Each information unit has a page reference within that Chapter. The information units provide a quick and easy way to find just the right piece of technical information you are looking for.

example information unit	Stack valve - Sectional View (A.10.A.18 - C.10.A.30)				
Information Unit ICE code	A	10.A	18	C	10.A.30
ICE code classification	Distribution systems	Primary hydraulic power	Stack valve	Functional data	Sectional view

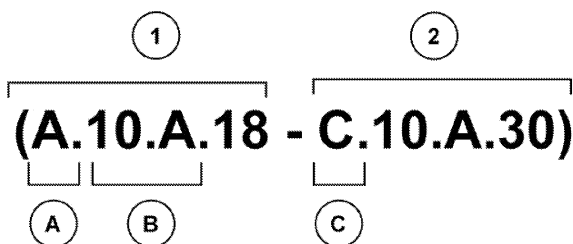

CRIL03J033E01 1

Navigate to the correct information unit you are searching for by identifying the function and information type from the ICE code.

- (1) Function and (2) Information type.
- (A) corresponds to the sections of the repair manual.
 (B) corresponds to the chapters of the repair manual.
 (C) corresponds to the type of information listed in the chapter contents, (D), Technical data, (C), Functional Data, (G), Diagnostic, and (F), Service.
 (A) and (B) are also shown in the page numbering on the page footer.
 THE REST OF THE CODING IS NOT LISTED IN ALPHA-NUMERIC ORDER IN THIS MANUAL.
- You will find a table of contents at the beginning and end of each section and chapter.
 You will find an alphabetical index at the end of each chapter.
- By referring to (A), (B) and (C) of the coding, you can follow the contents or index (page numbers) and quickly find the information you are looking for.

Page Header and Footer

The page header will contain the following references:

- Section and Chapter description

The page footer will contain the following references:

- Publication number for that Manual, Section or Chapter.
- Version reference for that publication.
- Publication date
- Section, chapter and page reference e.g. A.10.A / 9

General specification

BOLT TORQUE INFORMATION

DECIMAL HARDWARE

1. Fasteners should be replaced with the same or higher grade. If higher grade fasteners are used, these should only be tightened to the strength of the original.
2. Make sure the fasteners threads are clean and that thread engagement is started. This will prevent them from failing when being tightened.
3. Tighten plastic insert or crimped steel-type lock nuts to approximately **50 %** of the dry torque, applied to the nut, not to the bolt head. Tighten toothed or serrated-type lock nuts to the full torque value.
4. The L9 (Alloy) fasteners torque values are for a bolt, nut, and two washers.
When using L9 (Alloy) fasteners, do not use the values in this table for tapped holes.

GRADE							
	1 or 2	5	5.1	5.2	8	8.2	L9 (Alloy)
SAE Markings for Bolts and Cap Screws							
SAE Markings for Hex Nuts							

SIZE	GRADE 2 *				GRADE 5, 5.1 or 5.2				GRADE 8 or 8.2				GRADE L9 (Alloy)			
	Dry **		Lubricated **		Dry**		Lubricated **		Dry**		Lubricated **		Head		Nut	
	Nm	lb/ft	Nm	lb/ft	Nm	lb/ft	Nm	lb/ft	Nm	lb/ft	Nm	lb/ft	Nm	lb/ft	Nm	lb/ft
1/4 UNF	7.5	5.5	5.7	4.2	10.8	8	8.5	6.3	16.3	12	12.2	9	13.6	10	14.9	11
1/4 UNC	8.5	6.3	6.4	4.7	13.6	10	9.8	7.2	19	14	13.6	10	16.3	12	17.6	13
5/16 UNF	15	11	11	8	23	17	18	13	33	24	24	18	26	19	28	21
5/16 UNC	16	12	12	9	26	19	19	14	37	27	27	20	27	20	31	23
3/8 UNF	27	20	20	15	41	30	31	23	61	45	47	35	41	30	45	33
3/8 UNC	31	23	23	17	47	35	34	25	68	50	47	35	47	35	52	38
7/16 UNF	43	32	33	24	68	50	47	35	95	70	68	50	75	55	81	60
7/16 UNC	49	36	37	27	75	55	54	40	108	80	81	60	81	60	88	65
1/2 UNF	68	50	47	35	102	75	75	55	149	110	108	80	115	85	129	95
1/2 UNC	75	55	54	40	115	85	88	65	163	120	122	90	129	95	142	105
9/16 UNF	95	70	75	55	149	110	108	80	203	150	149	110	163	120	190	140
9/16 UNC	108	80	81	60	163	120	122	90	231	170	176	130	183	135	203	150
5/8 UNF	136	100	102	75	203	150	149	110	285	210	217	160	231	170	251	185

INTRODUCTION

SIZE	GRADE 2 *				GRADE 5, 5.1 or 5.2				GRADE 8 or 8.2				GRADE L9 (Alloy)			
	Dry **		Lubricated **		Dry**		Lubricated **		Dry**		Lubricated **		Head		Nut	
	Nm	lb/ft	Nm	lb/ft	Nm	lb/ft	Nm	lb/ft	Nm	lb/ft	Nm	lb/ft	Nm	lb/ft	Nm	lb/ft
5/8 UNC	149	110	115	85	231	170	176	130	325	240	244	180	258	190	278	205
3/4 UNF	237	175	176	130	353	260	271	200	515	380	380	280	359	265	393	290
3/4 UNC	271	200	190	140	407	300	298	220	570	420	420	310	447	330	481	355
7/8 UNF	231	170	170	125	583	430	434	320	814	600	610	450	644	475	685	505
7/8 UNC	244	180	190	140	637	470	475	350	909	670	678	500	705	520	793	585
1 UNF	339	250	258	190	868	640	651	480	1234	910	922	680	746	550	1051	775
1 UNC	380	280	285	210	976	720	732	540	1383	1020	1031	760	949	700	1220	900
1-1/8 UNF	475	350	366	270	1071	790	800	590	1749	1290	1315	970	1390	1025	1559	1150
1-1/8 UNC	542	400	407	300	1207	890	909	670	1953	1440	1464	1080	1559	1150	1797	1325
1-1/4 UNF	678	500	515	380	1519	1120	1139	840	2468	1820	1844	1360	1898	1400	2170	1600
1-1/4 UNC	746	550	570	420	1681	1240	1261	930	2726	2010	2048	1510	2170	1600	2373	1750
1-1/2 UNF	1180	870	881	650	2644	1950	1980	1460	4285	3160	3214	2370	3932	2900	4407	3250
1-1/2 UNC	1329	980	990	730	2983	2200	2224	1640	4827	3560	3621	2670	4475	3300	4949	3650

IMPORTANT: DO NOT use these values if a different torque value or tightening procedure is given for a specific application. Torque values listed are for general use only. Check tightness of fasteners periodically. Shear bolts are designed to fail under predetermined loads. Always replace shear bolts with identical grade.

NOTES

- * - Grade 2 applies for hex caps (not hex bolts) up to **152 mm (6 in)** long. Grade 1 applies for hex cap screws over **152 mm (6 in)** long, and for all other types of bolts and screws of any length.
- ** - "Lubricated" means coated with a lubricant such as engine oil, or fasters with phosphate and oil coatings. "Dry" means plained or zinc plated without any lubrication.

TORQUE SPECIFICATIONS - METRIC HARDWARE

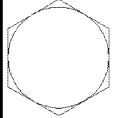
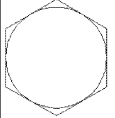
GRADE 8.8 Bolts, Nuts and Studs				GRADE 10.9 Bolts, Nuts and Studs		
Dry				Dry		
SIZE	Nm	lb/in	lb/ft	Nm	lb/in	lb/ft
						
M4	3 to 4	31 to 35		5 to 6	44 to 49	
M5	5 to 6	49 to 55		8 to 9	71 to 79	
M6	10 to 11	84 to 94		14 to 15	120 to 136	
M8	23 to 26	229 to 277		33 to 37	293 to 329	
M10	46 to 51	408 to 460		65 to 74		48 to 54
M12	80 to 90		59 to 66	114 to 128		85 to 94
M14	128 to 145		94 to 106	183 to 205		136 to 153
M16	200 to 220		149 to 161	285 to 320		208 to 235
M20	400 to 450		293 to 330	555 to 620		406 to 460
M24	690 to 780		510 to 575	955 to 1075		705 to 790

INTRODUCTION

GRADE 8.8 Bolts, Nuts and Studs				GRADE 10.9 Bolts, Nuts and Studs		
Dry				Dry		
SIZE	Nm	lb/in	lb/ft	Nm	lb/in	lb/ft
M30	1375 to 1545		1010 to 1140	1900 to 2140		1400 to 1580
M36	2400 to 2700		1770 to 1990	3315 to 3730		2445 to 2750

Use the above torques when specifications are not given.

These values apply to fasteners with both coarse and fine threads as received from supplier, plated or unplated, or when lubricated with engine oil. These values do not apply if graphite or Molydisulfide grease or oil is used. Use of a click type torque wrench, or better is required.

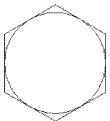
Grade 12.9 Bolts, Nuts, and Studs

Usually torque values specified to grade 10.9 fasteners can be used satisfactorily on grade 12.9 fasteners.

TORQUE SPECIFICATIONS - STEEL HYDRAULIC FITTINGS

37 Degree Flare Fitting						
Nom. SAE Dash Size	Tube OD/Hose ID		Thread Size	Newton metres	lb/in	lb/ft
-2			5/16 - 24	8 to 9	72 to 84	
-3			3/8 - 24	11 to 12	96 to 108	
-4	6.4 mm	1/4 inch	7/16 - 20	14 to 16	120 to 144	
-5	7.9 mm	5/16 inch	1/2 - 20	18 to 21	156 to 192	
-6	9.5 mm	3/8 inch	9/16 - 18	27 to 33	240 to 300	
-8	12.7 mm	1/2 inch	3/4 - 16	46 - 56	408 to 504	
-10	15.9 mm	5/8 inch	7/8 - 14	77 to 85	684 to 756	
-12	19.0 mm	3/4 inch	1-1/16 - 12	107 to 119		79 to 88
-14	22.2 mm	7/8 inch	1-3/16 - 12	127 to 140		94 to 103
-16	25.4 mm	1.0 inch	1-5/16 - 12	131 to 156		97 to 117
-20	31.8 mm	1-1/4 inch	1-5/8 - 12	197 to 223		145 to 165
-24	38.1 mm	1-1/2 inch	1-7/8 - 12	312 to 338		230 to 250

Straight Thread with O-ring						
Nom. SAE Dash Size	Tube OD/Hose ID		Thread Size	Newton metres	lb/in	lb/ft
-2			5/16 - 24	8 to 9	72 to 84	
-3			3/8 - 24	11 to 12	96 to 108	
-4	6.4 mm	1/4 inch	7/16 - 20	20 to 25	180 to 228	
-5	7.9 mm	5/16 inch	1/2 - 20	27 to 33	240 to 300	
-6	9.5 mm	3/8 inch	9/16 - 18	43 to 54	384 to 480	
-8	12.7 mm	1/2 inch	3/4 - 16	73 to 90	648 to 804	
-10	15.9 mm	5/8 inch	7/8 - 14	100 to 124		74 to 92
-12	19.0 mm	3/4 inch	1-1/16 - 12	138 to 173		102 to 128
-14	22.2 mm	7/8 inch	1-3/16 - 12	173 to 216		128 to 160
-16	25.4 mm	1.0 inch	1-5/16 - 12	203 to 253		150 to 187
-20	31.8 mm	1-1/4 inch	1-5/8 - 12	308 to 357		227 to 264
-24	38.1 mm	1-1/2 inch	1-7/8 - 12	492 to 542		363 to 400

Split Flange Mounting Bolts			
Size	Newton metres	lb/in	lb/ft
5/16 - 18	20 to 27	180 to 240	
3/8 - 16	27 to 34	240 to 300	
7/16 - 14	47 to 61	420 to 540	
1/2 - 13	74 to 88		55 to 65
5/8 - 11	190 to 203		140 to 150

INTRODUCTION

O-Ring Face Seal End						
Nom. SAE Dash Size	Tube OD		Thread Size	Newton metres	lb/in	lb/ft
-4	6.4 mm	1/4 inch	9/16 - 18	23 to 26	204 to 228	
-6	9.5 mm	3/8 inch	11/16 - 16	34 to 40	300 to 348	
-8	12.7 mm	1/2 inch	13/16 - 16	52 to 57	456 to 504	
-10	15.9 mm	5/8 inch	1-14	81 to 90	720 to 792	
-12	19.0 mm	3/4 inch	1-3/16 - 12	117 to 128		86 to 94
-16	25.4 mm	1.0 inch	1-7/16 - 12	152 to 174		112 to 128
-20	31.8 mm	1-1/4 inch	1-11/16 - 12	179 to 201		132 to 148
-24	38.1 mm	1-1/2 inch	2 - 12	213 to 235		157 to 173

O-Ring Boss End Fitting or Lock Nut				
Nom. SAE Dash Size	Thread Size	Newton metres	lb/in	lb/ft
-6	9/16 - 18	48 to 54	432 to 480	
-8	3/4 - 16	70 to 78	612 to 684	
-10	7/8 - 14	102 to 114		75 to 84
-12	1-1/16 - 12	142 to 160		105 to 117
-16	1-5/16 - 12	237 to 254		175 to 187

Pipe Fitting		
Nom. SAE Dash Size	Thread Size	TFFT (Turns For Finger Tight)
-2	1/8 - 27	2.0 - 3.0
-3	1/8 - 27	2.0 - 3.0
-4	1/8 - 27	2.0 - 3.0
-5	1/8 - 27	2.0 - 3.0
-6	1/4 - 18	1.5 - 3.0
-8	3/8 - 18	2.0 - 3.0
-10	1/2 - 14	2.0 - 3.0
-12	3/4 - 14	2.0 - 3.0
-14	3/4 - 14	2.0 - 3.0
-16	1 - 11-1/2	1.5 - 2.5
-20	1-1/4 - 11-1/2	1.5 - 2.5
-24	1-1/2 - 11-1/2	1.5 - 2.5
-32	2 - 11-1/2	1.5 - 2.5

NOTE: Apply sealant/lubricant to male pipe threads. The first two threads should be left uncovered to avoid system contamination. Screw pipe fitting into female pipe port to the finger tight position. Wrench tighten fitting to the appropriate turns from finger tight (TFFT) shown in table above, making sure the tube end of an elbow or tee fitting is aligned to receive incoming tube or hose fitting.

Conversion factors

Metric to U.S.			
	MULTIPLY	BY	TO OBTAIN
AREA:	square meter	10.763 91	square foot
	hectare	2.471 05	acre
FORCE:	newton	3.596 942	ounce force
	newton	2.224 809	pound force
LENGTH:	millimeter	0.039 370	inch
	meter	3.280 840	foot
	kilometer	0.621 371	mile
MASS:	kilogram	2.204 622	pound
MASS/AREA:	kilogram/hectare	0.000 466	ton/acre
MASS/ENERGY:	gr/kW/hr.	0.001 644	lbs/hp/hr.
MASS/VOLUME:	kg/cubic meter	1.685 555	lb/cubic yd.
POWER:	kilowatt	1.341 02	horsepower
PRESSURE:	kilopascal	0.145 038	lb/sq. inch
	bar	14.50385	lb/sq. inch
TEMPERATURE:	degree C	1.8 x C +32	degree F
TORQUE:	newton meter	8.850 748	lb/inch
	newton meter	0.737 562	lb/foot
VELOCITY:	kilometer/hr.	0.621 371	miles/hr.
VOLUME:	cubic centimeter	0.061 024	cubic inch
	cubic meter	35.314 66	cubic foot
	cubic meter	1.307 950	cubic yd.
	milliliter	0.033 814	ounce (US fluid)
	litre	1.056 814	quart (US liquid)
	litre	0.879 877	quart (Imperial)
	litre	0.264 172	gallon (US liquid)
	litre	0.219 969	gallon (Imperial)
VOLUME/TIME:	litre/min.	0.264 172	gallon/min. (US liquid)
	litre/min.	0.219 969	gallon/min. (Imperial)

U.S. to Metric			
	MULTIPLY	BY	TO OBTAIN
AREA:	square foot	0.092 903	square meter
	acre	0.404 686	hectare
FORCE:	ounce force	0.278 014	newton
	pound force	4.448 222	newton
LENGTH:	inch	25.4 *	millimeter
	foot	0.304 8 *	meter
	mile	1.609 344 *	kilometer
MASS:	pound	0.453 592	kilogram
	ounce	28.35	gram
MASS/AREA:	ton/acre	2241 702	kilogram/hectare
MASS/ENERGY:	lb/hp/hr	608.277 4	gr/kW/hr
MASS/VOLUME:	lb/cubic yd.	0.593 276	kg/cubic meter
POWER:	horsepower	0.745 700	kilowatt
PRESSURE:	lbs/sq. in	6.894 757	kilopascal
	lbs/sq. in	0.069	bar
	lbs/sq. in	0.070 303	kg/sq. cm
TEMPERATURE:	degree F	1.8 F - 32	degree C
TORQUE:	pound/inch	0.112 985	newton meter
	pound/foot	1.355 818	newton meter
VELOCITY:	miles/hr.	1.609 344 *	kilometer/hr.

INTRODUCTION

U.S. to Metric			
	MULTIPLY	BY	TO OBTAIN
VOLUME:	cubic inch	16.387 06	cubic centimeter
	cubic foot	0.028 317	cubic meter
	cubic yard	0.764.555	cubic meter
	ounce (US fluid)	29.573 53	milliliter
	quart (US liquid)	0.946 353	litre
	quart (Imperial)	1.136 523	litre
	gallon (US)	3.785 412	litre
	gallon (Imperial)	4.546 092	litre
VOLUME/TIME:	gallon/min.	3.785 412	litre/min.

Hydraulic contamination

Contamination in the hydraulic system is a major cause of the malfunction of hydraulic components. Contamination is any foreign material in the hydraulic oil. Contamination can enter the hydraulic system in several ways.

- (A) When you drain the oil or disconnect any line.
- (B) When you disassemble a component.
- (C) From normal wear of the hydraulic components.
- (D) From damaged or worn seals.
- (E) From a damaged component in the hydraulic system.

All hydraulic systems operate with some contamination. The design of the components in this hydraulic system permits efficient operation with a small amount of contamination. An increase in this amount of contamination can cause problems in the hydraulic system. The following list includes some of these problems.

- (A) Cylinder rod seals leak.
- (B) Control valve spools do not return to neutral.
- (C) Movement of control valve spools is difficult.
- (D) Hydraulic oil becomes too hot.
- (E) Pump gears, housing, and other parts wear rapidly.
- (F) Relief valves or check valves held open by dirt.
- (G) Quick failure of components that have been repaired.
- (H) Cycle times are slow; machine does not have enough power.

If your machine has any of these problems, check the hydraulic oil for contamination. There are two types of contamination, microscopic and visible.

Microscopic contamination occurs when very fine particles of foreign material are in suspension in the hydraulic oil. These particles are too small to see or feel. Microscopic contamination can be found by identification of the following problems or by testing in a laboratory. Examples of the problems:

- (A) Cylinder rod seal leak.
- (B) Control valve spools do not return to NEUTRAL.
- (C) The hydraulic system has a high operating temperature.

Visible contamination is foreign material that can be found by sight, touch, or odor. Visible contamination can cause a sudden failure of components. Examples of visible contamination:

- (A) Particles of metal or dirt in the oil.
- (B) Air in the oil.
- (C) The oil is dark and thick.
- (D) The oil has an odor of burned oil.
- (E) Water in the oil.

If you find contamination, use a Portable Filter to clean the hydraulic system.



REPAIR MANUAL
DISTRIBUTION SYSTEMS



750L
850L

Contents

DISTRIBUTION SYSTEMS - A

PRIMARY HYDRAULIC POWER SYSTEM 750L , 850L	A.10.A
SECONDARY HYDRAULIC POWER SYSTEM 750L , 850L	A.12.A
ELECTRICAL POWER SYSTEM 750L , 850L	A.30.A
LIGHTING SYSTEM 750L , 850L	A.40.A
FAULT CODES 750L , 850L	A.50.A



DISTRIBUTION SYSTEMS - A

PRIMARY HYDRAULIC POWER SYSTEM - 10.A

750L
850L

Contents

DISTRIBUTION SYSTEMS - A

PRIMARY HYDRAULIC POWER SYSTEM - 10.A

TECHNICAL DATA

PRIMARY HYDRAULIC POWER SYSTEM

Special tools	4
General specification	7
Capacity	7
Stack valve	
Torque	8
Special tools	8
Calibration	8
General specification	8
Hydraulic pump	
Torque	9
General specification	9

FUNCTIONAL DATA

Relief valve	
Exploded view	10
Sectional view	11
Stack valve	
Exploded view	12
Filter	
External view	13

SERVICE

PRIMARY HYDRAULIC POWER SYSTEM

Cleaning	14
Decontaminating	16
Relief valve	
Pressure test	20
Pressure setting	21
Disassemble	22
Visual inspection	26
Assemble	27
Stack valve	
Flow test	28
Remove	32
Disassemble	33

Inlet section - Disassemble	35
Visual inspection	36
Assemble	37
Inlet section - Assemble	39
Install	40
Hydraulic pump	
Flow test	41
Remove	43
Disassemble without PTO	44
Visual inspection without PTO	48
Assemble without PTO	50
Disassemble with PTO	54
Visual inspection with PTO	61
Assemble with PTO	63
Preliminary test	68
Install	69
Reservoir	
Apply vacuum	70
DIAGNOSTIC	
Sensing system	
Filter restriction sensor - Testing	71

PRIMARY HYDRAULIC POWER SYSTEM - Special tools



B877558M_1 1

CAS1804 PRESSURE TEST KIT

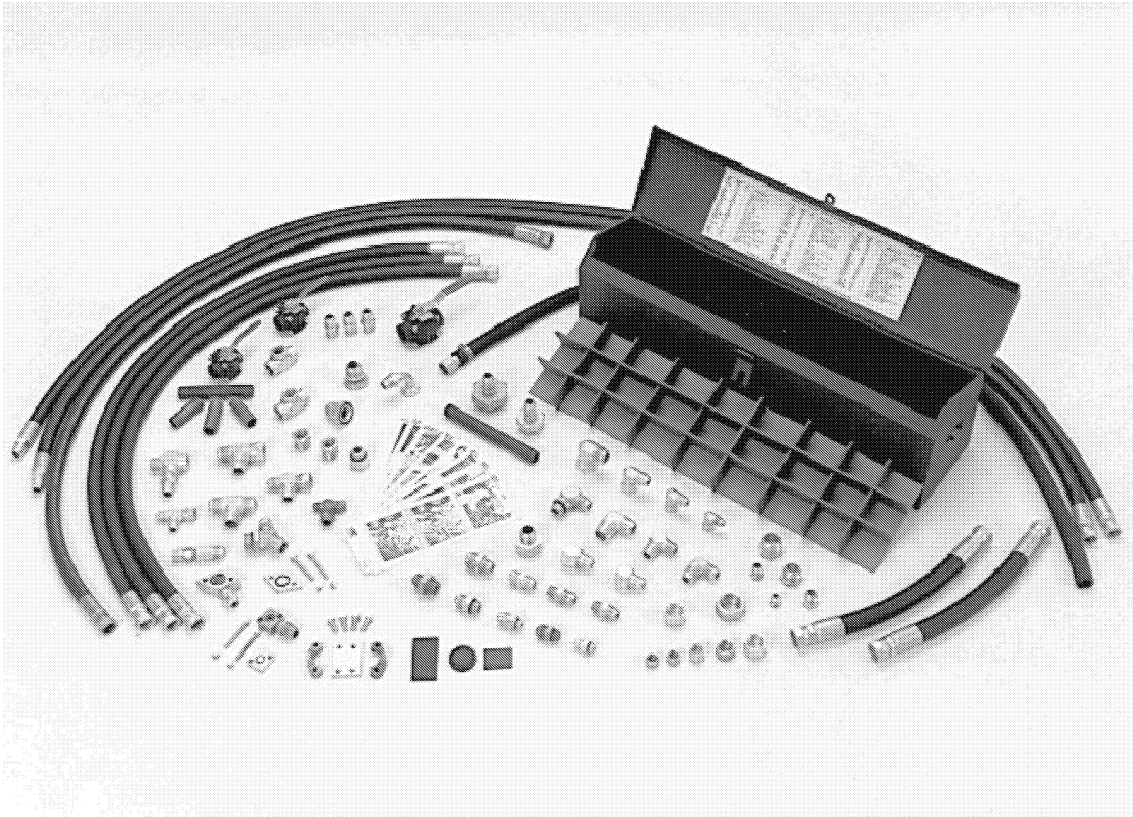

CAS1808 2

CAS1808 FLOWMETER FITTING KIT

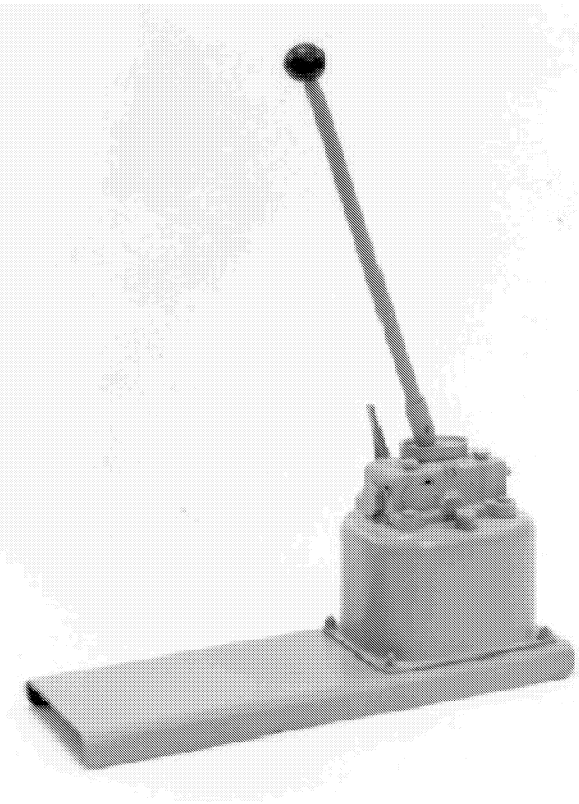

CAS10090 3

CAS10090 HAND PUMP

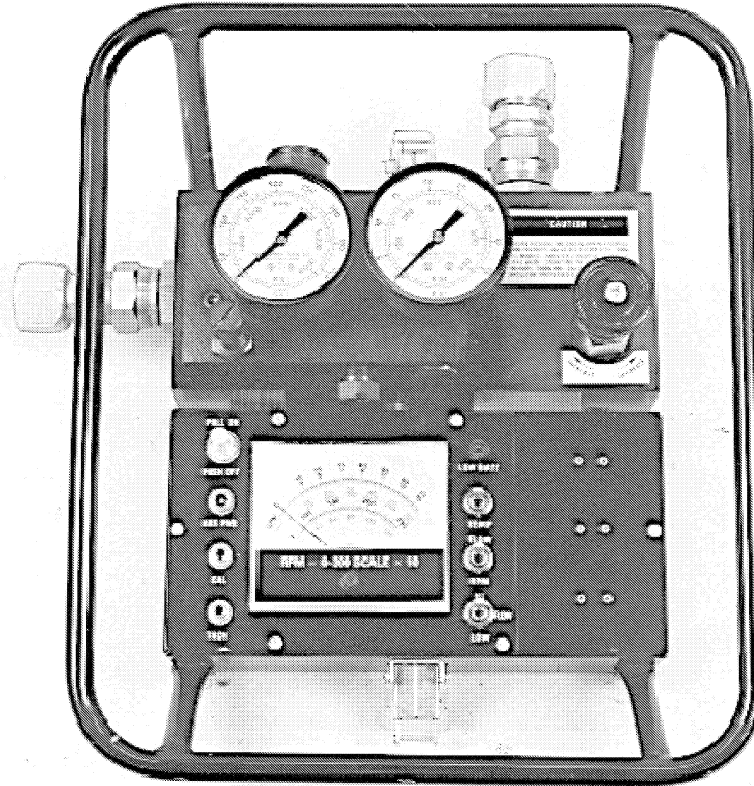

CAS10280 4
CAS10280 FLOWMETER

PRIMARY HYDRAULIC POWER SYSTEM - General specification

Type of oil	CASE AKCELA AW68 HYD FLUID
Temperature of hydraulic oil when testing	52 - 79 °C (125 - 175 °F)
Hydraulic pump output	76.8 L at 207 bar at 2000 RPM 20.3 US gpm at 3000 psi at 2000 RPM
Neutral system pressure	12 - 15 bar (180 - 220 psi) at 2000 RPM
Main relief valve pressure All models at 2000 RPM	203 - 214 bar (2950 - 3100 psi)
Circuit relief valves A and B ports ripper/auxiliary section	214 - 227 bar (3100 - 3300 psi) with hand pump
Dozer blade lift speed	457 mm second (18 in second)
Dozer blade lift time (measure from ground level to full height)	2 seconds

PRIMARY HYDRAULIC POWER SYSTEM - Capacity

NOTE: Transmission and hydraulic system use the same reservoir.

Hydraulic reservoir refill capacity	75.7 L 20 US gal
-------------------------------------	------------------

Stack valve - Torque

Special torques	Nm	lb
Bolts and nuts that fasten the sections together	39 - 47 Nm	28.7 - 34.6 lb ft
Relief valves and load check valves	24 - 30 Nm	17.7 - 22 lb ft
Allen head screws	12 - 15 Nm	106 - 133 lb in
Centering spring screw	13 - 16 Nm	115 - 142 lb in

Stack valve - Special tools

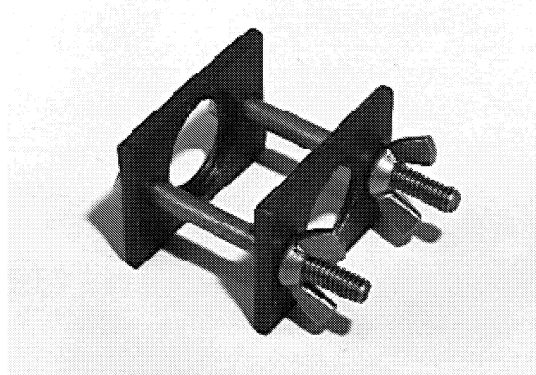

B786802M 1

CAS1147-2 CENTERING SPRING COMPRESSION TOOL

Stack valve - Calibration

Relief Valves	bar	psi
Main relief valve	203 - 214 bar	2950 - 3100 psi
Circuit relief valves tested with hand pump	214 - 227 bar	3100 - 3300 psi

Stack valve - General specification

Spool travel	MM	Inch
Neutral to pressure - lift, tilt and auxiliary	7.9 mm	0.31 in
Neutral to pressure - angle section	6.6 mm	0.26 in
Neutral to float - lift	13.5 mm	0.53 in

Hydraulic pump - Torque

Non PTO pump cover bolts	66 - 80 Nm 49 - 59 lb ft
Air vent	9 Nm (80 lb in)
Pump housing bolts	271 Nm (200 lb ft)
PTO shaft retainer	68 Nm (50 lb ft)
Set screw PTO shaft retainer	9 Nm (80 lb in)
Shaft cover screws	8 - 9 Nm (67 - 77 lb in)

Hydraulic pump - General specification

Equipment pump output	76.8 L/min at 207 bar at 2000 RPM 20.3 US gpm at 3000 psi at 2000 RPM
Rotation	Clockwise as seen from end of shaft

Relief valve - Exploded view

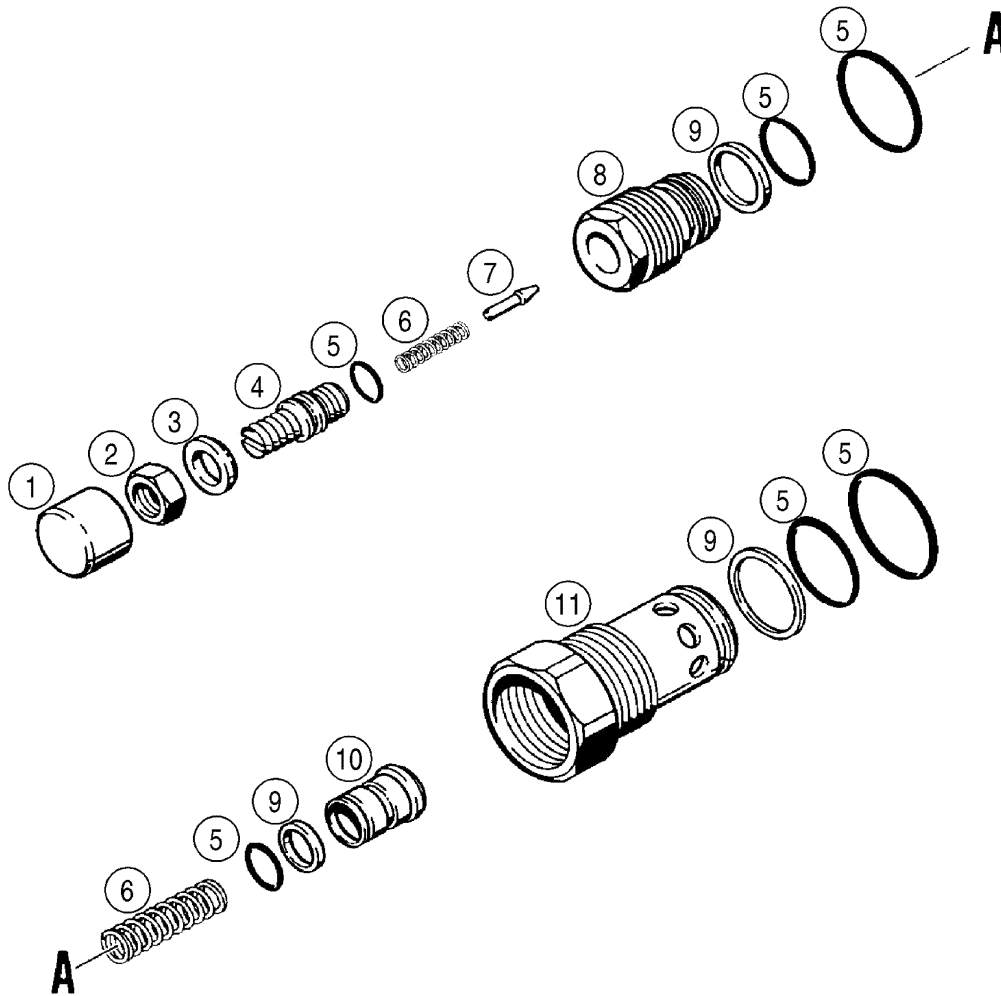

BS99M034 1

(1) Cap	(5) O-ring	(9) Backup ring
(2) Lock nut	(6) Spring	(10) Poppet
(3) Spacer	(7) Plunger	(11) Housing
(4) Adjusting screw	(8) Body	

Relief valve - Sectional view

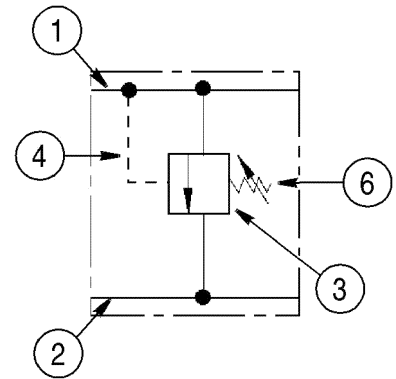
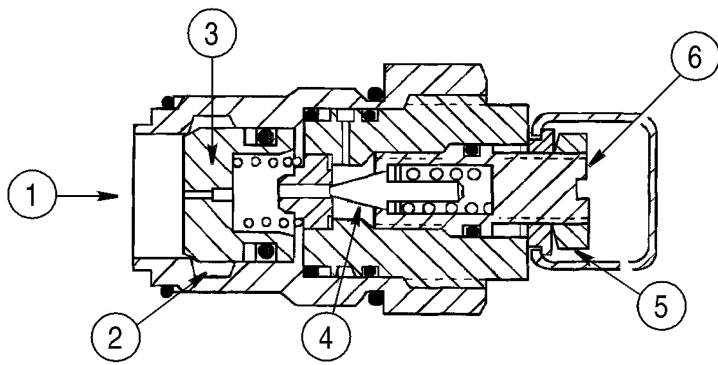

BS00A057 1

(1) Inlet port passage	(4) Pilot passage poppet
(2) Return port passage	(5) Jam nut
(3) Main relief poppet	(6) Pressure adjusting screw



Suggest:

If the above button click is invalid.

Please download this document

first, and then click the above link

to download the complete manual.

Thank you so much for reading

Stack valve - Exploded view

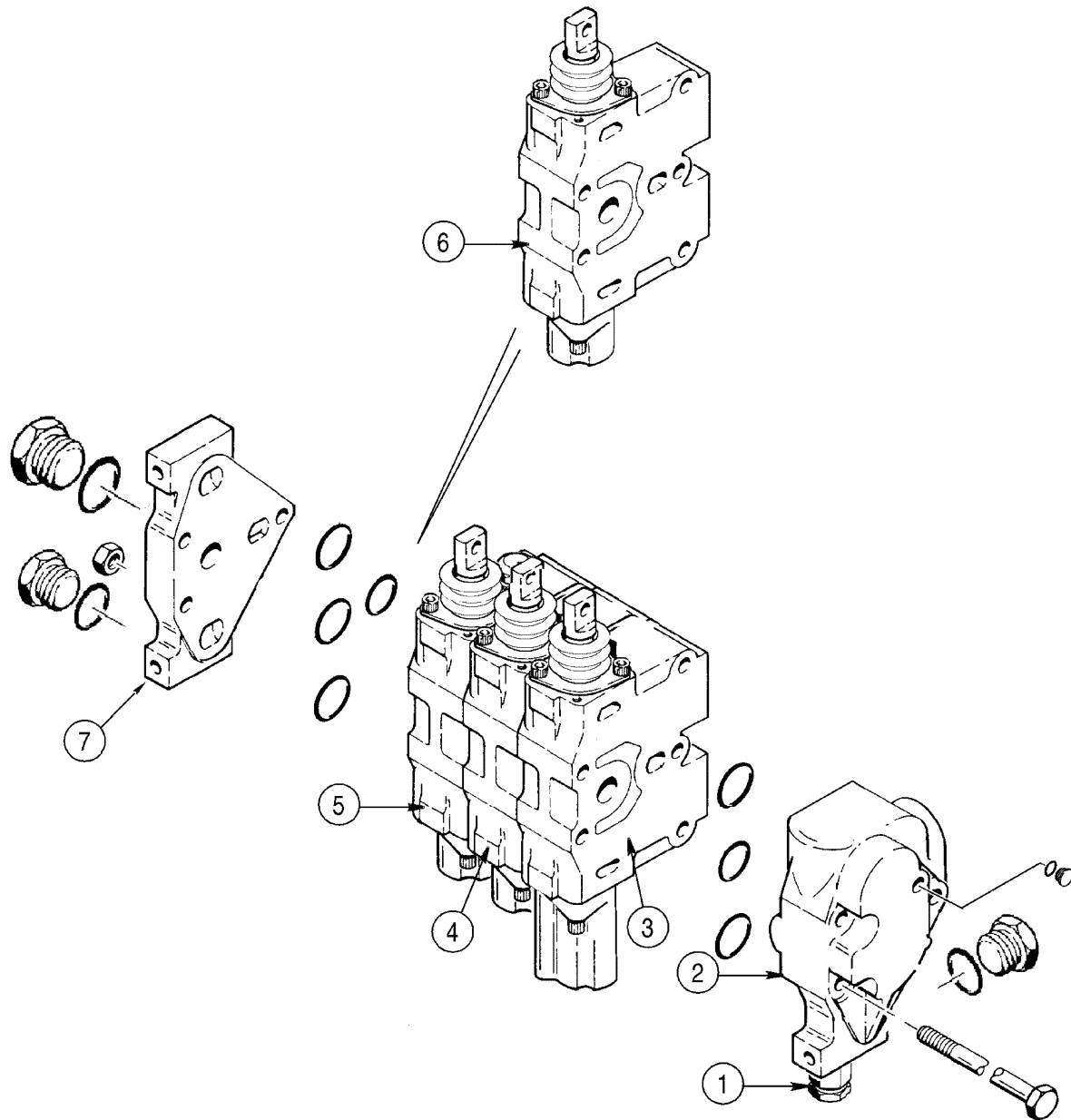

BC02J007 1

(1) Main relief valve	(5) Dozer angle section
(2) Inlet section	(6) Ripper/auxiliary section
(3) Dozer lift section	(7) Outlet section
(4) Dozer tilt section	

<https://www.ebooklibonline.com>

Hello dear friend!

Thank you very much for reading.

Enter the link into your browser.

The full manual is available for immediate download.

<https://www.ebooklibonline.com>