

JOHN DEERE
WORLDWIDE COMMERCIAL & CONSUMER
EQUIPMENT DIVISION

John Deere Tractors
LA100 Series

TM2371 MAY 2008

TECHNICAL MANUAL



JOHN DEERE

North American Version
Litho In U.s.a.

INTRODUCTION

Introduction

Manual Description

This technical manual is written for an experienced technician and contains sections that are specifically for this product. It is a part of a total product support program.

The manual is organized so that all the information on a particular system is kept together. The order of grouping is as follows:

- Table of Contents
- Specifications and Information
- Identification Numbers
- Tools and Materials
- Component Location
- Schematics and Harnesses
- Theory of Operation
- Operation and Diagnostics
- Diagnostics
- Tests and Adjustments
- Repair
- Other

Note: Depending on the particular section or system being covered, not all of the above groups may be used.

The bleed tabs for the pages of each section will align with the sections listed on this page. Page numbering is consecutive from the beginning of the Safety section through the last section.

We appreciate your input on this manual. If you find any errors or want to comment on the layout of the manual please contact us.

Safety

Specifications and Information

Engine (B&S - Single Cylinder)

Engine (B&S - V-Twin)

Electrical

Power Train (Gear)

Power Train (Hydrostatic)

Steering

Brakes

Attachments

Miscellaneous

All information, illustrations and specifications in this manual are based on the latest information at the time of publication. The right is reserved to make changes at any time without notice.

COPYRIGHT© 2008
Deere & Co.
John Deere Worldwide Commercial and
Consumer Equipment Division
All rights reserved
Previous Editions
COPYRIGHT© 2006

<https://www.ebooklibonline.com>

Hello dear friend!

Thank you very much for reading.

Enter the link into your browser.

The full manual is available for immediate download.

<https://www.ebooklibonline.com>

SAFETY

Safety

Recognize Safety Information

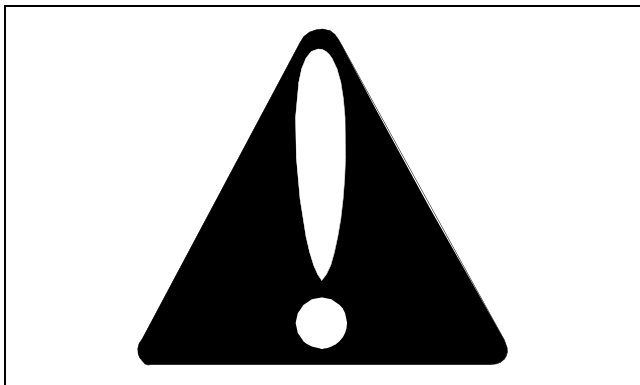

MIF

This is the safety-alert symbol. When you see this symbol on your machine or in this manual, be alert to the potential for personal injury.

Follow recommended precautions and safe servicing practices.

Special Messages

Your manual contains special messages to bring attention to potential safety concerns, machine damage as well as helpful operating and servicing information. Please read all the information carefully to avoid injury and machine damage.



Caution: Avoid Injury! This symbol and text highlight potential hazards or death to the operator or bystanders that may occur if the hazards or procedures are ignored.

Important: Avoid Damage! This text is used to tell the operator of actions or conditions that might result in damage to the machine.

Note: *General information is given throughout the manual that may help the operator in the operation or service of the machine.*

Replace Safety Signs

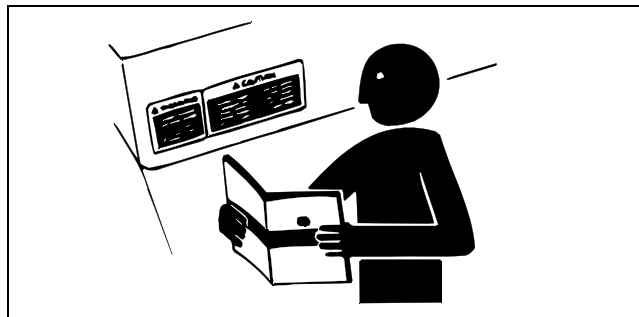

MIF

Replace missing or damaged safety signs. See the machine operator's manual for correct safety sign placement.

Understand Signal Words

A signal word - DANGER, WARNING, or CAUTION - is used with the safety-alert symbol. DANGER identifies the most serious hazards.

DANGER or WARNING safety signs are located near specific hazards. General precautions are listed on CAUTION safety signs. CAUTION also calls attention to safety messages in this manual.

Handle Fluids Safely - Avoid Fires

Be Prepared For Emergencies

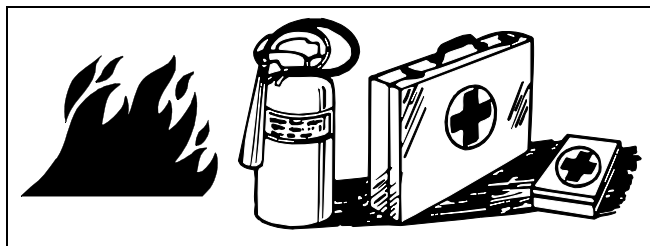

MIF

- When you work around fuel, do not smoke or work near heaters or other fire hazards.
- Store flammable fluids away from fire hazards. Do not incinerate or puncture pressurized containers.
- Make sure machine is clean of trash, grease, and debris.
- Do not store oily rags; they can ignite and burn spontaneously.
- Be prepared if a fire starts.
- Keep a first aid kit and fire extinguisher handy.
- Keep emergency numbers for doctors, ambulance service, hospital, and fire department near your telephone.

SAFETY

Use Care In Handling and Servicing Batteries

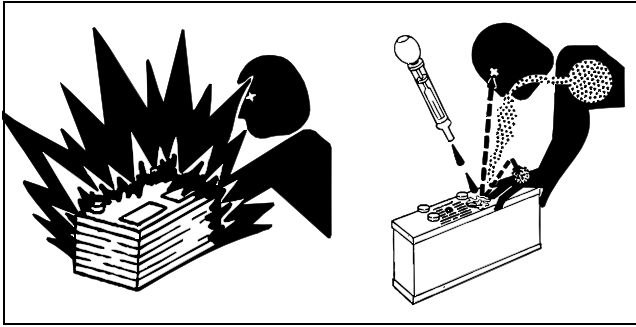

MIF

Prevent Battery Explosions

- Keep sparks, lighted matches, and open flame away from the top of battery. Battery gas can explode.
- Never check battery charge by placing a metal object across the posts. Use a volt-meter or hydrometer.
- Do not charge a frozen battery; it may explode. Warm battery to 16°C (60°F).

Prevent Acid Burns

- Sulfuric acid in battery electrolyte is poisonous. It is strong enough to burn skin, eat holes in clothing, and cause blindness if splashed into eyes.

Avoid acid burns by:

1. Filling batteries in a well-ventilated area.
2. Wearing eye protection and rubber gloves.
3. Avoiding breathing fumes when electrolyte is added.
4. Avoiding spilling or dripping electrolyte.
5. Use proper jump start procedure.

If you spill acid on yourself:

1. Flush your skin with water.
2. Apply baking soda or lime to help neutralize the acid.
3. Flush your eyes with water for 10 - 15 minutes.
4. Get medical attention immediately.

If acid is swallowed:

1. Drink large amounts of water or milk.
2. Then drink milk of magnesia, beaten eggs, or vegetable oil.
3. Get medical attention immediately.

Wear Protective Clothing

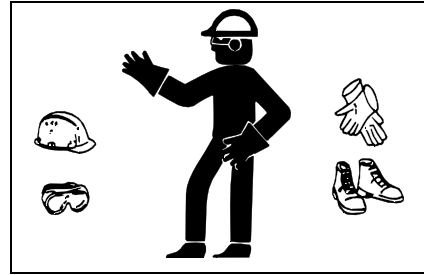

MIF

Wear close fitting clothing and safety equipment appropriate to the job.

Prolonged exposure to loud noise can cause impairment or loss of hearing. Wear a suitable hearing protective device such as earmuffs or earplugs to protect against objectionable or uncomfortable loud noises.

Operating equipment safely requires the full attention of the operator. Do not wear radio or music headphones while operating machine.

Parking Safely

1. Stop machine on a level surface, not on a slope.
2. Disengage PTO and stop attachments.
3. Lower attachments to the ground.
4. Lock park brake.
5. Stop engine.
6. Remove key.
7. Wait for engine and all moving parts to stop before you leave the operator's station.
8. Close fuel shut-off valve, if your machine is equipped.

Service Machines Safely

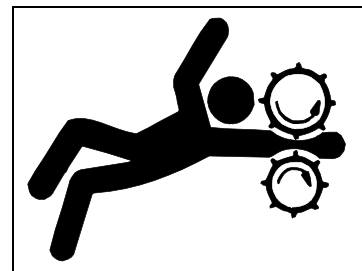

MIF

Tie long hair behind your head. Do not wear a necktie, scarf, loose clothing, or necklace when you work near machine tools or moving parts. If these items were to get caught, severe injury could result.

Remove rings and other jewelry to prevent electrical shorts and entanglement in moving parts.

SAFETY

Use Proper Tools

Use tools appropriate to the work. Makeshift tools and procedures can create safety hazards. Use power tools only to loosen threaded parts and fasteners. For loosening and tightening hardware, use the correct size tools. **DO NOT** use U.S. measurement tools on metric fasteners. Avoid bodily injury caused by slipping wrenches. Use only service parts meeting John Deere specifications.

Work in Clean Area

Before starting a job:

1. Clean work area and machine.
2. Make sure you have all necessary tools to do your job.
3. Have the right parts on hand.
4. Read all instructions thoroughly; do not attempt shortcuts.

Support Machine Properly and Use Proper Lifting Equipment

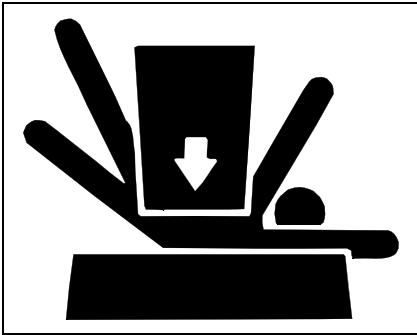

MIF

If you must work on a lifted machine or attachment, securely support the machine or attachment.

Do not support the machine on cinder blocks, hollow tiles, or props that may crumble under continuous load. Do not work under a machine that is supported solely by a jack. Follow recommended procedures in this manual.

Lifting heavy components incorrectly can cause severe injury or machine damage. Follow recommended procedure for removal and installation of components in the manual.

Using High Pressure Washers

Directing pressurized water at electronic/electrical components or connectors, bearings, hydraulic seals, fuel injection pumps or other sensitive parts and components may cause product malfunctions. Reduce pressure and spray at a 45 to 90 degree angle.

Illuminate Work Area Safely

Illuminate your work area adequately but safely. Use a portable safety light for working inside or under the machine. Make sure the bulb is enclosed by a wire cage. The hot filament of an accidentally broken bulb can ignite spilled fuel or oil.

Work In Ventilated Area

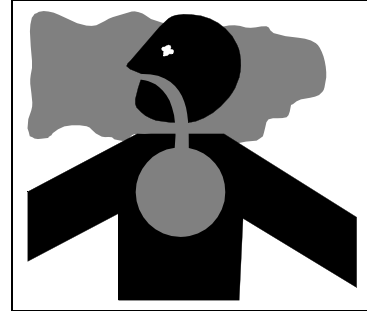

MIF

Engine exhaust fumes can cause sickness or death. If it is necessary to run an engine in an enclosed area, remove the exhaust fumes from the area with an exhaust pipe extension.

If you do not have an exhaust pipe extension, open the doors and get outside air into the area.

Warning: California Proposition 65 Warning

Gasoline engine exhaust from this product contains chemicals known to the State of California to cause cancer, birth defects, or other reproductive harm.

Diesel engine exhaust and some of its constituents are known to the State of California to cause cancer, birth defects, and other reproductive harm.

Remove Paint Before Welding or Heating

Avoid potentially toxic fumes and dust. Hazardous fumes can be generated when paint is heated by welding, soldering, or using a torch. Do all work outside or in a well ventilated area. Dispose of paint and solvent properly. Remove paint before welding or heating: If you sand or grind paint, avoid breathing the dust. Wear an approved respirator. If you use solvent or paint stripper, remove stripper with soap and water before welding. Remove solvent or paint stripper containers and other flammable material from area. Allow fumes to disperse at least 15 minutes before welding or heating.

SAFETY

Avoid Harmful Asbestos Dust

Avoid breathing dust that may be generated when handling components containing asbestos fibers. Inhaled asbestos fibers may cause lung cancer.

Components in products that may contain asbestos fibers are brake pads, brake band and lining assemblies, clutch plates, and some gaskets. The asbestos used in these components is usually found in a resin or sealed in some way. Normal handling is not hazardous as long as airborne dust containing asbestos is not generated.

Avoid creating dust. Never use compressed air for cleaning. Avoid brushing or grinding material containing asbestos. When servicing, wear an approved respirator. A special vacuum cleaner is recommended to clean asbestos. If not available, apply a mist of oil or water on the material containing asbestos. Keep bystanders away from the area.

Service Tires Safely



MIF

Explosive separation of a tire and rim parts can cause serious injury or death.

Do not attempt to mount a tire unless you have the proper equipment and experience to perform the job.

Always maintain the correct tire pressure. Do not inflate the tires above the recommended pressure. Never weld or heat a wheel and tire assembly. The heat can cause an increase in air pressure resulting in a tire explosion. Welding can structurally weaken or deform the wheel.

When inflating tires, use a clip-on chuck and extension hose long enough to allow you to stand to one side and NOT in front of or over the tire assembly. Use a safety cage if available.

Check wheels for low pressure, cuts, bubbles, damaged rims or missing lug bolts and nuts.

Avoid Injury From Rotating Blades and Augers

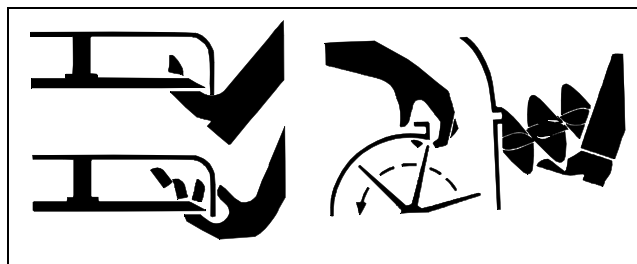

MIF

Keep hands and feet away while machine is running. Shut off power to service, lubricate or remove mower blades, augers or PTO shafts.

Handle Chemical Products Safely

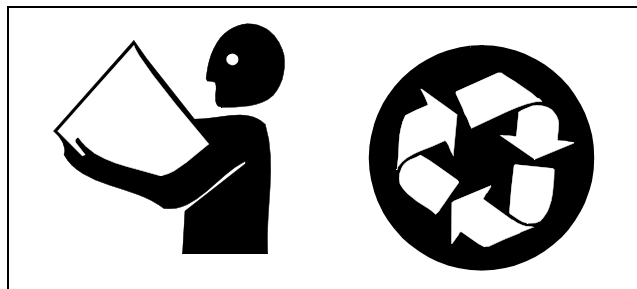

MIF

Direct exposure to hazardous chemicals can cause serious injury. Potentially hazardous chemicals used with John Deere equipment include such items as lubricants, coolants, paints, and adhesives.

A Material Safety Data Sheet (MSDS) provides specific details on chemical products: physical and health hazards, safety procedures, and emergency response techniques. Check the MSDS before you start any job using a hazardous chemical. That way you will know exactly what the risks are and how to do the job safely. Then follow procedures and recommended equipment.

Dispose of Waste Properly

Improperly disposing of waste can threaten the environment and ecology. Potentially harmful waste used with John Deere equipment include such items as oil, fuel, coolant, brake fluid, filters, and batteries. Use leakproof containers when draining fluids. Do not use food or beverage containers that may mislead someone into drinking from them. Do not pour waste onto the ground, down a drain, or into any water source. Inquire on the proper way to recycle or dispose of waste from your local environmental or recycling center, or from your John Deere dealer.

SAFETY

Live with Safety



MIF

Before returning machine to customer, make sure machine is functioning properly, especially the safety systems. Install all guards and shields.

SAFETY



SPECIFICATIONS AND INFORMATION TABLE OF CONTENTS

Table of Contents

Fastener Torques	9
Metric Fastener Torque Values	9
Metric Fastener Torque Value - Grade 7.....	10
Inch Fastener Torque Values	11
General Information	12
Gasoline	12
Gasoline Storage.....	12
4 - Cycle Gasoline Engine Oil	12
Break-In Engine Oil - 4-Cycle Gasoline.....	13
Alternative Lubricants	13
Synthetic Lubricants	13
Lubricant Storage	14
Mixing Of Lubricants.....	14
Grease.....	14
Hydrostatic Transmission Oil.....	14
Serial Number Locations	15
Machine Product Identification Number	15
Engine Serial Number	15
Transaxle Serial Number.....	15

SPECIFICATIONS AND INFORMATION TABLE OF CONTENTS

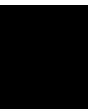

SPECIFICATIONS AND INFORMATION FASTENER TORQUES

Fastener Torques

Metric Fastener Torque Values

Property Class and Head Markings				
Property Class and Nut Markings				

MIF

SIZE	Class 4.8				Class 8.8 or 9.8				Class 10.9				Class 12.9			
	Lubricated a		Dry a		Lubricated a		Dry a		Lubricated a		Dry a		Lubricated a		Dry a	
	N•m	lb-ft	N•m	lb-ft	N•m	lb-ft	N•m	lb-ft	N•m	lb-ft	N•m	lb-ft	N•m	lb-ft	N•m	lb-ft
M6	4.8	3.5	6	4.5	9	6.5	11	8.5	13	9.5	17	12	15	11.5	19	14.5
M8	12	8.5	15	11	22	16	28	20	32	24	40	30	37	28	47	35
M10	23	17	29	21	43	32	55	40	63	47	80	60	75	55	95	70
M12	40	29	50	37	75	55	95	70	110	80	140	105	130	95	165	120
M14	63	47	80	60	120	88	150	110	175	130	225	165	205	150	260	109

DO NOT use these hand torque values if a different torque value or tightening procedure is given for a specific application. Torque values listed are for general use only and include a $\pm 10\%$ variance factor. Check tightness of fasteners periodically. DO NOT use air powered wrenches.

Shear bolts are designed to fail under predetermined loads. Always replace shear bolts with identical grade.

Fasteners should be replaced with the same class. Make sure fastener threads are clean and that you properly start thread engagement. This will prevent them from failing when tightening.

When bolt and nut combination fasteners are used, torque values should be applied to the NUT instead of the bolt head.

Tighten toothed or serrated-type lock nuts to the full torque value.

a "Lubricated" means coated with a lubricant such as engine oil, or fasteners with phosphate and oil coatings.

"Dry" means plain or zinc plated (Yellow Dichromate - Specification JDS117) without any lubrication.

Reference: JDS - G200







SPECIFICATIONS AND INFORMATION FASTENER TORQUES

Metric Fastener Torque Value - Grade 7

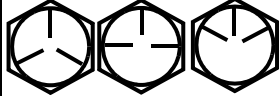
Size	Steel or Gray Iron Torque		Aluminum Torque	
	N•m	lb-ft	N•m	lb-ft
M6	11	8	8	6
M8	24	18	19	14
M10	52	38	41	30
M12	88	65	70	52
M14	138	102	111	82

SPECIFICATIONS AND INFORMATION FASTENER TORQUES

Inch Fastener Torque Values

SAE Grade and Head Markings	1 or 2 ^b No Marks 	5 5.1 5.2 	8 8.2 
SAE Grade and Nut Markings	2 No Marks 	5  	8  

MIF

SIZE	Grade 1		Grade 2b				Grade 5, 5.1 or 5.2				Grade 8 or 8.2					
	Lubricated a		Dry a		Lubricated a		Dry a		Lubricated a		Dry a		Lubricated a		Dry a	
	N•m	lb-ft	N•m	lb-ft	N•m	lb-ft	N•m	lb-ft	N•m	lb-ft	N•m	lb-ft	N•m	lb-ft	N•m	lb-ft
1/4	3.7	2.8	4.7	3.5	6	4.5	7.5	5.5	9.5	7	12	9	13.5	10	17	12.5
5/16	7.7	5.5	10	7	12	9	15	11	20	15	25	18	28	21	35	26
3/8	14	10	17	13	22	16	27	20	35	26	44	33	50	36	63	46
7/16	22	16	28	20	35	26	44	32	55	41	70	52	80	58	100	75
1/2	33	25	42	31	53	39	67	50	85	63	110	80	120	90	150	115
9/16	48	36	60	45	75	56	95	70	125	90	155	115	175	130	225	160
5/8	67	50	85	62	105	78	135	100	170	125	215	160	215	160	300	225
3/4	120	87	150	110	190	140	240	175	300	225	375	280	425	310	550	400
7/8	190	140	240	175	190	140	240	175	490	360	625	450	700	500	875	650
1	290	210	360	270	290	210	360	270	725	540	925	675	1050	750	1300	975
1-1/8	470	300	510	375	470	300	510	375	900	675	1150	850	1450	1075	1850	1350

DO NOT use these hand torque values if a different torque value or tightening procedure is given for a specific application. Torque values listed are for general use only and include a ±10% variance factor. Check tightness of fasteners periodically. DO NOT use air powered wrenches.

Shear bolts are designed to fail under predetermined loads. Always replace shear bolts with identical grade.

Fasteners should be replaced with the same grade. Make sure fastener threads are clean and that you properly start thread engagement. This will prevent them from failing when tightening.

When bolt and nut combination fasteners are used, torque values should be applied to the NUT instead of the bolt head.

Tighten toothed or serrated-type lock nuts to the full torque value.

a "Lubricated" means coated with a lubricant such as engine oil, or fasteners with phosphate and oil coatings. "Dry" means plain or zinc plated (yellow dichromate - Specification JDS117) without any lubrication.

b "Grade 2" applies for hex cap screws (Not Hex Bolts) up to 152 mm (6 in.) long. "Grade 1" applies for hex cap screws over 152 mm (6 in.) long, and for all other types of bolts and screws of any length.

Reference: JDS - G200

General Information

Gasoline



Caution: Avoid Injury! Gasoline is HIGHLY FLAMMABLE, handle it with care. **DO NOT** refuel machine while:

indoors, always fill gas tank outdoors

machine is near an open flame or sparks

engine is running, **STOP** engine

engine is hot, allow it to cool sufficiently first
smoking

Help prevent fires:

fill gas tank to bottom of filler neck only

be sure fill cap is tight after fueling

clean up any gas spills **IMMEDIATELY**

keep machine clean and in good repair - free of
excess grease, oil, debris, and faulty or
damaged parts

any storage of machines with gas left in tank
should be in an area that is well ventilated to
prevent possible igniting of fumes by an open
flame or spark, this includes any appliance
with a pilot light

To prevent fire or explosion caused by **STATIC
ELECTRIC DISCHARGE** during fueling:

ONLY use a clean, approved **POLYETHYLENE
PLASTIC** fuel container and funnel **WITHOUT**
any metal screen or filter

To avoid engine damage:

- DO NOT mix oil with gasoline
- **ONLY** use clean, fresh unleaded gasoline with an octane rating (anti-knock index) of 87 or higher
- fill gas tank at the end of each day's operation to help prevent condensation from forming inside a partially filled tank
- keep up with specified service intervals

Use of alternative oxygenated, gasohol blended, unleaded gasoline is acceptable as long as:

- the ethyl or grain alcohol blends DO NOT exceed 10% by volume or

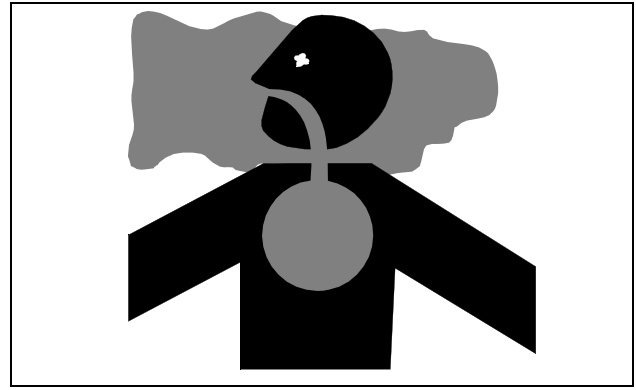

mif

- methyl tertiary butyl ether (MTBE) blends DO NOT exceed 15% by volume

Important: Avoid Damage! DO NOT use METHANOL gasolines because METHANOL is harmful to the environment and to your health.



Caution: Avoid Injury! California Proposition 65 Warning: Gasoline engine exhaust from this product contains chemicals known to the State of California to cause cancer, birth defects, or other reproductive harm.

Gasoline Storage

Important: Avoid Damage! Keep all dirt, scale, water or other foreign material out of gasoline.

Keep gasoline stored in a safe, protected area. Storage of gasoline in a clean, properly marked ("UNLEADED GASOLINE") POLYETHYLENE PLASTIC container WITHOUT any metal screen or filter is recommended. DO NOT use de-icers to attempt to remove water from gasoline or depend on fuel filters to remove water from gasoline. Use a water separator installed in the storage tank outlet. BE SURE to properly discard unstable or contaminated gasoline. When storing machine or gasoline, it is recommended that you add **John Deere Gasoline Conditioner and Stabilizer (TY15977)** or an equivalent to the gasoline. BE SURE to follow directions on container and to properly discard empty container.

4 - Cycle Gasoline Engine Oil

Use the appropriate oil viscosity based on the expected air temperature range during the period between recommended oil changes. Operating outside of these recommended oil air temperature ranges may cause premature engine failure.

The following John Deere oil is PREFERRED:

SPECIFICATIONS AND INFORMATION GENERAL INFORMATION

- **TURF - GARD® - SAE 10W-30.**
- **PLUS - 4® - SAE 10W-30;**

The following John Deere oils are **also recommended**, based on their specified temperature range:

- **TORQ - GARD SUPREME® - SAE 30.**

Other oils may be used if above John Deere oils are not available, provided they meet one of the following specifications:

- SAE 5W-30 - API Service Classification SG or higher;
- SAE 10W-30 - API Service Classifications SG or higher;
- SAE 30 - API Service Classification SC or higher.

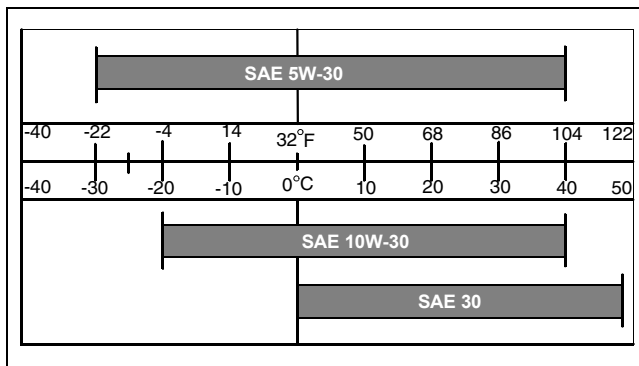

Break-In Engine Oil - 4-Cycle Gasoline

Important: Avoid Damage! ONLY use a quality break-in oil in rebuilt or remanufactured engines for the first 5 hours (maximum) of operation. DO NOT use oils with heavier viscosity weights than SAE 5W-30, these oils will not allow rebuilt or remanufactured engines to break-in properly.

The following John Deere oil is **PREFERRED**:

- **BREAK - IN ENGINE OIL.**

John Deere BREAK - IN ENGINE OIL is formulated with special additives for aluminum and cast iron type engines to allow the power cylinder components (pistons, rings, and liners as well) to “wear-in” while protecting other engine components, valve train and gears, from abnormal wear. Engine rebuild instructions should be followed closely to determine if special requirements are necessary.

John Deere BREAK - IN ENGINE OIL is also recommended for non-John Deere engines, both aluminum and cast iron types.

The following John Deere oil is **also recommended**:

- **TORQ - GARD SUPREME® - SAE 5W-30.**

If the above recommended John Deere oils are not available, use a break-in engine oil meeting the following

specification during the first **5 hours (maximum)** of operation:

- SAE 5W-30 - API Service Classification SE or higher.

Important: Avoid Damage! After the break-in period, use the John Deere oil that is recommended for this engine.

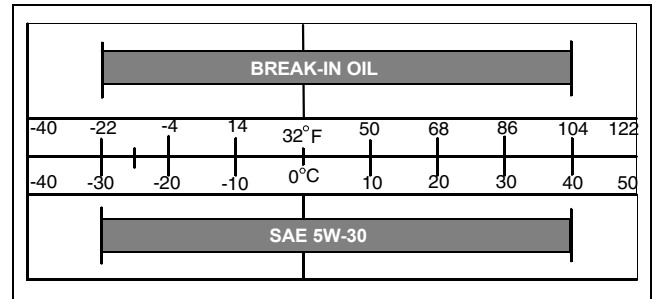

Alternative Lubricants

Conditions in certain geographical areas outside the United States and Canada may require different lubricant recommendations than the ones printed in this technical manual or the operator's manual. Consult with your John Deere Dealer, or Sales Branch, to obtain the alternative lubricant recommendations.

Important: Avoid Damage! Use of alternative lubricants could cause reduced life of the component.

If alternative lubricants are to be used, it is recommended that the factory fill be thoroughly removed before switching to any alternative lubricant.

Synthetic Lubricants

Synthetic lubricants may be used in John Deere equipment if they meet the applicable performance requirements (industry classification and/or military specification) as shown in this manual.

The recommended air temperature limits and service or lubricant change intervals should be maintained as shown in the operator's manual.

Avoid mixing different brands, grades, or types of oil. Oil manufacturers blend additives in their oils to meet certain specifications and performance requirements. Mixing different oils can interfere with the proper functioning of these additives and degrade lubricant performance.

SPECIFICATIONS AND INFORMATION GENERAL INFORMATION

Lubricant Storage

All machines operate at top efficiency only when clean lubricants are used. Use clean storage containers to handle all lubricants. Store them in an area protected from dust, moisture, and other contamination. Store drums on their sides. Make sure all containers are properly marked as to their contents. Dispose of all old, used containers and their contents properly.

Mixing Of Lubricants

In general, avoid mixing different brands or types of lubricants. Manufacturers blend additives in their lubricants to meet certain specifications and performance requirements. Mixing different lubricants can interfere with the proper functioning of these additives and lubricant properties which will downgrade their intended specified performance.

Grease

Important: Avoid Damage! Use recommended John Deere greases to avoid component failure and premature wear.

The recommended John Deere greases are effective within an average air temperature range of -29 to 135 degrees C (-20 to 275 degrees F).

If operating outside that temperature range, contact your Servicing dealer for a special-use grease.

The following greases are preferred:

- John Deere Multi-Purpose SD Polyurea Grease
- John Deere Multi-Purpose HD Lithium Complex Grease

If not using any of the preferred greases, be sure to use a general all-purpose grease with an NLGI grade No.2 rating.

Wet or high speed conditions may require use of a special-use grease. Contact your Servicing dealer for information.

Hydrostatic Transmission Oil

These machines are equipped with a internal wet disc brake transmission (Hydrostatic transmission).

Important: Avoid Damage! Use ONLY the following oils for service. DO NOT use automatic transmission fluid.

Note: The T40 and K46 transmissions are filled with 10W30 engine oil at the factory.

For the T40 or K46 transmissions used in extreme or high-hour applications, J20C Hygard Hydraulic oil or 5W-50 Synthetic Engine Oil is approved as an optional fill. Use only after a complete drain of the factory oil.

SPECIFICATIONS AND INFORMATION SERIAL NUMBER LOCATIONS

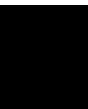

ENGINE - GAS TABLE OF CONTENTS

Table of Contents

Specifications	19	Flywheel Removal and Installation	46
General Specifications	19	Crankshaft and Cam Gear Removal.....	47
Tests and Adjustments Specifications.....	19	Balance System Removal and Installation ..	48
Repair Specifications.....	19	Crankshaft/Cam Gear Installation.....	49
Torque Specifications (Alphabetical).....	20	Magneto Bearing Inspection	50
Special or Essential Tools	21	Cam Gear Bearing Inspection	51
Other Materials	22	PTO Journal Inspection and	
Diagnostics	22	Seal Replacement	51
Starting Problems.....	22	Starting Motor Removal and Installation.....	52
Tests and Adjustments	23	Starting Motor Disassembly	52
Throttle/Choke Cable Adjustment	23	Starting Motor Assembly.....	54
Fuel Shutoff Solenoid Test.....	23	Starting Motor Pinion Gear Replacement....	56
Governor Adjustment - Static	24		
Governor Adjustment - Dynamic	25		
Governed Idle Adjustment.....	25		
Slow Idle Carburetor Adjustment.....	26		
Valve Clearance Adjustment	26		
Armature Air Gap Adjustment	27		
Crankcase Vacuum Test	28		
Cylinder Leakdown Test.....	28		
Repair	29		
Upper Blower Housing Removal and			
Installation	29		
Air Cleaner Service	29		
Carburetor Removal and Installation.....	30		
Carburetor Disassembly.....	31		
Carburetor Inspection.....	32		
Carburetor Assembly.....	32		
Breather Valve Service.....	33		
Engine Removal	34		
Engine Installation	35		
Cylinder Head Removal and Installation	36		
Cylinder Head Inspection and Repair.....	38		
Valve Removal	39		
Valves Reface	39		
Valves Installation	40		
Governor Removal and Installation	41		
Piston, Rings and Rod.....	41		
Piston Inspection	43		
Connecting Rod Inspection	43		
Cylinder Bore Inspection	45		
Cylinder Bore Honing	45		
Cylinder Bore Cleaning	45		
Resizing Cylinder Bore.....	46		

ENGINE - GAS TABLE OF CONTENTS



ENGINE - GAS SPECIFICATIONS

Specifications

General Specifications

Specifications:

Make	Briggs & Stratton
Series	Intek
Type	Gasoline
Stroke/Cycle	4
Models	31P677 and 31P707
Cylinders	1
Valves	Overhead Valves
Displacement	502 cm ³ (30.63 cu in.)
Bore	90.68 mm (3.57 in.)
Stroke	77.72 mm (3.06 in.)
Cooling System	Air Cooled
Lubrication 31P707 engine	Oil Slinger
Lubrication 31P677 engine	Pressurized with Filter
Crankcase Oil Capacity	1.4 L (1.5 qt)
Air Cleaner	Paper with outer foam element
Muffler	Horizontal discharge below frame
Fuel Filter	Replaceable (In-Line Type)
Aspiration	Normal
Alternator	.9 amp regulated

Tests and Adjustments Specifications

Valve Clearance:

Slow Idle (governed)	1750 rpm
Fast Idle	3350 ± 100 rpm
Spark Plug Gap	0.76 mm (0.030 in.)
Spark Plug Torque	20 N•m (180 lb-in.)
Valve Clearance - Intake	0.08 - 0.13 mm (0.003 - 0.005 in.)
Valve Clearance - Exhaust	0.13 - 0.18 mm (0.005 - 0.007 in.)
Valve Guide Depth	0.12 - 0.15 mm (0.005 - 0.006 in.)
Magneto Air Gap	0.25 - 0.35 mm (0.010 - 0.014 in.)

Repair Specifications

Cylinder Bore, Pistons and Rings:

Cylinder Bore Maximum Dimension	90.51 mm (3.563 in.)
Cylinder Bore Minimum Dimension	90.47 mm (3.562 in.)
Cylinder Bore Out of Round (maximum)	0.04 mm (0.002 in.)
Piston Pin (Wear Limit)	20.29 mm (0.799 in.)
Piston Pin Bore (Wear Limit)	20.35 mm (0.801 in.)

Ring End Gap (Wear Limit) Case Iron Bore:

Compression Ring (Top)	0.64 mm (0.025 in.)
------------------------	---------------------

ENGINE - GAS SPECIFICATIONS

Compression Ring (Center)	0.76 mm (0.030 in.)
Oil Ring	0.76 mm (0.030 in.)
Compression and Oil Ring Groove Wear Limit (New Rings Installed)	0.15 mm (0.006 in.)

Valves:

Valve Guide (Wear Limit)	6.09 mm (0.240 in.)
Valve Seat Width	0.79 - 1.98 mm (0.031 - 0.078 in.)
Valve Margin (Minimum)	0.40 mm (0.016 in.)
Valve Face Angle	45°
Valve Seat Narrowing Angle	30°

Connecting Rod and Crankshaft:

Connecting Rod Crankpin (Wear Limit)	38.15 mm (1.502 in.)
Connecting Rod Piston Pin Bearing (Wear Limit)	20.37 mm (0.802 in.)
Crankshaft PTO Journal (Wear Limit)	41.20 mm (1.622 in.)
Crankshaft Magneto Journal (Wear Limit)	34.95 mm (1.376 in.)
Crankshaft Crankpin Journal (Wear Limit)	38.02 mm (1.497 in.)
Crankshaft Eccentric Journal (Wear Limit)	55.93 mm (2.202 in.)
PTO Bearing (Wear Limit)	41.37 mm (1.629 in.)
Magneto Bearing (Wear Limit)	35.13 mm (1.383 in.)
Crankshaft End Play	0.05 - 0.58 mm (0.002 - 0.023 in.)
Cam Gear PTO Journal (Wear Limit)	12.65 mm (0.498 in.)
Cam Gear Magneto Journal (Wear Limit)	12.65 mm (0.498 in.)
Cam Lobe (Wear Limit)	30.07 mm (1.184 in.)
Cam Gear Bearing (Wear Limit)	12.80 mm (0.504 in.)
Compression Release Lobe	0.25 mm (0.010 in.)

Counterweight:

Crankshaft Eccentric Journal (Wear Limit)	55.93 mm (2.202 in.)
Counterweight Link Bearing (Wear Limit)	56.13 mm (2.210 in.)

Torque Specifications (Alphabetical)

Specifications:

Armature Mounting Screws	2.8 N•m (25 lb-in.)
Blower Housing Screws	10 N•m (85 lb-in.)
Breather Mounting Bolts	3 N•m (25 lb-in.)
Carburetor to Intake Manifold	8 N•m (70 lb-in.)
Carburetor Bowl Screw	4.5 N•m (40 lb-in.)
Connecting Rod Cap Screws	21 N•m (186 lb-in.)
Control Bracket Screws	3.4 N•m (30 lb-in.)
Cylinder Head Cap Screws	25 N•m (220 lb-in.)
Drive Belt Idler Pulley	9.6 N•m (85 lb-in.)
Engine Mounting Bolts	32 N•m (24 lb-ft)
Engine Output Pulley Assembly	75 N•m (55 lb-ft)
Exhaust Manifold	18.5 N•m (165 lb-in.)
Flywheel Fan Screws	16 N•m (140 lb-in.)
Flywheel Nut	136 N•m (100 lb-ft)
Flywheel Screen Screws	4.5 N•m (40 lb-in.)

ENGINE - GAS SPECIFICATIONS

Fuel Pump Bracket.....	7.3 N•m (65 lb-in.)
Fuel Pump to Bracket.....	4.0 N•m (35 lb-in.)
Fuel Shutoff Solenoid.....	5 N•m (44 lb-in.)
Governor Arm Lock Nut.....	4.5 N•m (40 lb-in.)
Heat Shield Screws.....	4.5 N•m (40 lb-in.)
Ignition Armature.....	2.8 N•m (25 lb-in.)
Intake Manifold Elbow.....	11 N•m (100 lb-in.)
Oil Filter Adaptor Screws.....	14 N•m (125 lb-in.)
Oil Pump Cover Screws.....	9 N•m (80 lb-in.)
Rocker Arm Adjustment Lock Nut.....	5 N•m (45 lb-in.)
Rocker Arm Mounting.....	11.3 N•m (100 lb-in.)
Spark Plug.....	20 N•m (180 lb-in.)
Starting Motor Mounting Bolts.....	16 N•m (140 lb-in.)
Starting Motor Through Bolts.....	6 N•m (50 lb-in.)
Stator to Cylinder Block.....	2.3 N•m (21 lb-in.)
Sump Cover.....	20 N•m (180 lb-in.)
Throttle Valve Plate.....	4.5 N•m (40 lb-in.)
Valve Cover Nuts.....	6 N•m (55 lb-in.)
Voltage Regulator/Rectifier.....	7.3 N•m (65 lb-in.)

Special or Essential Tools

Special or Required Tools

Tool Name	Tool No.	Tool Use
Pulse Tachometer, or Digital Tachometer	JT07270 JT05719	Governor, and governed and slow idle adjustments.
Cylinder Leak Tester	JTO3502	Cylinder leakdown test.
Pressure Gauge Hose Assembly Connector	JT07034 JT03017 JT05847	Oil pressure test.
Vacuum Gauge Bar Fitting Line and Plug	JT03503 JT05703 JT05699 and 8741-F66	Crankcase vacuum test.
Briggs & Stratton Flywheel Tool	B&S Tool No. 19203	Remove flywheel.

Note: Order tools according to information given in the U.S. SERVICE-GARD™ Catalog or in the European Microfiche Tool Catalog (MTC).

ENGINE - GAS DIAGNOSTICS

Other Materials

Other Material

Part No.	Part Name	Part Use
TY24416	Multipurpose Lithium Grease	Apply to engine crankshaft. Pack oil seals.
	SCOTCH-BRIGHT™ Abrasive Sheets/Pads	Clean cylinder head.
	Valve Guide Cleaner	Clean valve guides.
	Stanisol or Kerosene	Finish ream valve guide.
	Prussian Blue Compound	Check valve seat contact.
	Zinc Oxide/Wood Alcohol	Check block for cracks.
	Mineral Spirits	Clean electric starter armature.

Diagnostics

Starting Problems



Caution: Avoid Injury! Be aware! The engine may start to rotate at any time. Keep hands away from all moving parts when testing.

Note: To test specific electrical components, see Electrical section and refer to either Diagnostics or Tests and Adjustments for further guidance.

Symptom: Engine Will Not Crank

Problem

Cause - Solution

1. Battery

a. Charge and test battery. See "Battery Voltage and Specific Gravity Tests" on page 170 in the Electrical section.

b. Replace the battery if it will not take or hold a charge.

2. Starting Motor
Solenoid does not click when ignition switch is turned to start position.

a. Cranking circuit problem. See "Cranking Circuit Diagnosis - All Models" on page 146 in the Electrical section.

b. Key switch malfunction. See "Key Switch Test" on page 178 in the Electrical section.

c. Starting motor solenoid malfunction. See "Starting Solenoid Test - All Models" on page 172 in the Electrical section.



Caution: Avoid Injury! Do not rotate engine with starter if the spark plug is removed. Gasoline spray from the open cylinder may be ignited by ignition spark and cause an explosion or fire.

Note: Perform a visual inspection first to determine if battery cables are tight and not corroded. The battery must be sufficient size to turn the engine over at minimum cranking speed of 350 rpm.

ENGINE - GAS TESTS AND ADJUSTMENTS

Tests and Adjustments

Symptom: Engine Cranks But Will Not Start

Problem	Cause - Solution
1. Engine cranks slowly.	a. Charge and test battery. See "Battery Voltage and Specific Gravity Tests" on page 170 in the Electrical section. b. Replace the battery if it will not hold a charge.
2. Poor or no spark at spark plug.	a. Replace spark plug, b. Ignition coil gap incorrect. See "Armature Air Gap Adjustment" on page 27. c. Magneto shorted to ground, flywheel magnet weak.
3. Choke or throttle not adjusted properly.	a. Adjust cable. See "Throttle/Choke Cable Adjustment" on page 23.
4. Fuel supply.	a. Check air cleaner, fuel mixture, possible contaminated fuel, or stuck float needle. b. Check fuel shutoff valve, fuel lines, fuel pump, and engine vacuum.
5. Fuel shutoff solenoid does not open when ignition switch is turned to start/run.	a. Check fuel solenoid and ignition circuit. See "Ignition and Shutoff Circuit Diagnosis - All Models" on page 151 and "Fuel Shutoff Solenoid Test" on page 182 in the Electrical section.
6. Valve clearance improperly.	a. Check and adjust valve clearance. See "Valve Clearance Adjustment" on page 26.
7. Internal components binding.	a. Remove spark plug and turn the engine over by hand. If the engine is hard to turn over by hand repair or replace engine.

Throttle/Choke Cable Adjustment

Reason:

To make sure the throttle cable moves the throttle and choke through its full range of movement.

Procedure:

1. Move throttle lever all the way forward to Start (Choke) position.

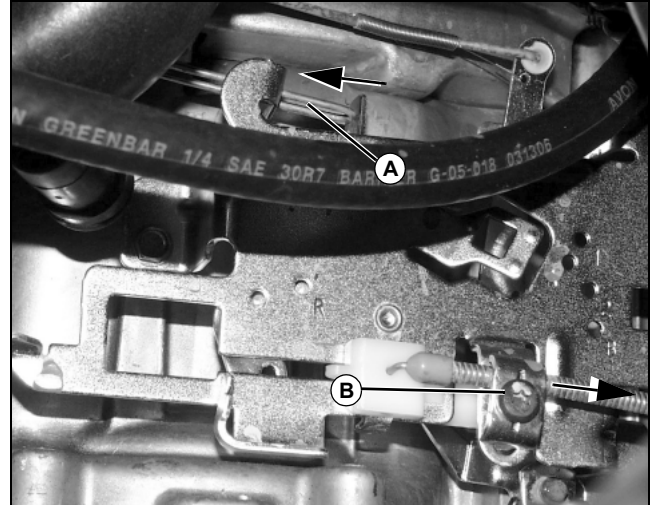

MX38035

2. Locate choke control rod (A) on right side of engine at top of throttle control plate.
3. With your fingers or a needle nose pliers, try and move choke rod (A) toward carburetor (top arrow).
4. If choke control rod moves toward carburetor, choke is not completely closing and throttle cable needs to be adjusted.
5. Loosen throttle cable clamp (B).
6. Slide the throttle cable as far as it will go to the right.
7. Tighten throttle cable clamp (B).

Fuel Shutoff Solenoid Test

Reason:

To test proper operation of fuel shutoff solenoid.

Required Tools:

- Two Jumper wires

Procedure:

1. Park machine safely.
2. Listen for an audible click when ignition switch is turned

ENGINE - GAS TESTS AND ADJUSTMENTS

from OFF to ON.

3. If solenoid does not click, problem could be in machine wiring. See electrical section.

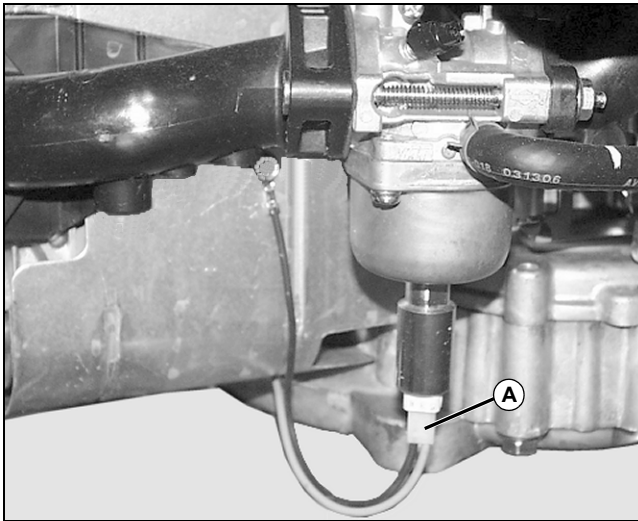

MX38036A

4. Disconnect wire (A) from solenoid.
5. Place one jumper wire between one of the fuel solenoid terminals and a good ground. Place second jumper wire on battery positive terminal and momentarily touch other solenoid terminal.

Note: If battery voltage drops below 9 volts when cranking engine or while engine is running, the solenoid will not function.

6. If solenoid clicks when wire contacts terminal, the solenoid is working properly.

Results:

- Solenoid is operating properly if a click is heard when ignition switched from OFF to ON.

Governor Adjustment - Static

(Engine OFF)



Caution: Avoid Injury! Before starting or running engine, static adjustment of the governor must be made. Failure to make static adjustments first, could result in engine overspeeding, and may result in engine or equipment damage, personal injury and/or property damage.

Reason:

To remove any slack in governor linkage that would allow engine to overspeed.

Procedure:

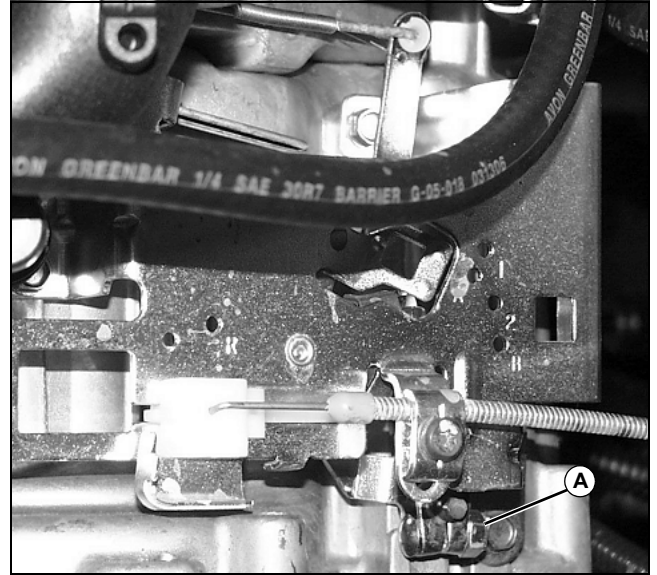

MX38038

1. Loosen governor lever pinch bolt nut (A).
2. Move throttle lever to FAST.

Important: Avoid Damage! Do not bend governor link or distort governor arm.

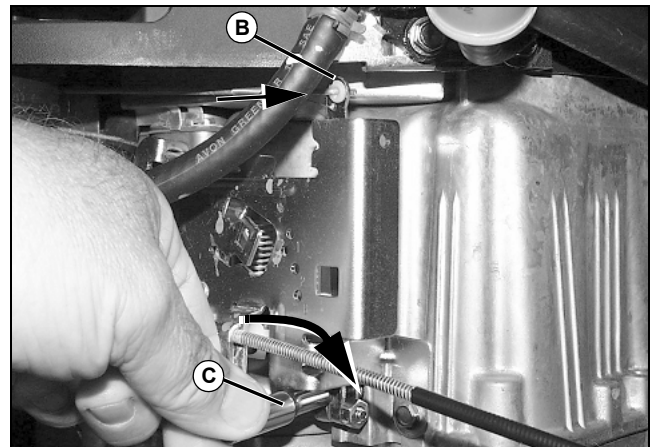

MX38040

3. Hold governor arm (B) in FAST position (top arrow) and using 3/16 inch socket, turn governor shaft clockwise until it stops.
4. Hold governor arm and shaft in position. Tighten governor arm pinch bolt nut to specification.

Specification:

Lock Nut 4.5 N•m (40 lb-in.)

ENGINE - GAS TESTS AND ADJUSTMENTS

Governor Adjustment - Dynamic

(Full Throttle - No Load)

Reason:

To verify the engine speed settings are within limits.

Equipment:

- JT07270 Pulse Tachometer, or
- JT05719 Digital Tachometer

Procedure:



Caution: Avoid Injury! Before starting or running engine, static adjustment of the governor must be made. Failure to make static adjustments first, could result in engine overspeeding, and may result in engine or equipment damage, personal injury and/or property damage.

1. With engine running, set throttle lever to FAST.
2. Measure engine rpm.

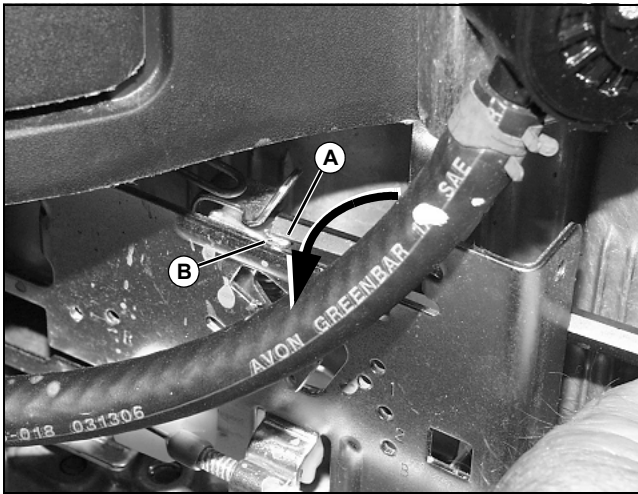

MX38039

Picture Note: Arrow denotes direction to increase speed.

Important: Avoid Damage! Do not bend governor link or distort governor arm.

3. Insert the governor adjusting tool (A) and bend the upper governor spring anchor (B) to adjust the top no load engine rpm to specification.
4. Bend the anchor UP (counter clockwise) to lengthen the spring and increase the rpm, or DOWN (clockwise) to shorten the spring and reduce the engine rpm.

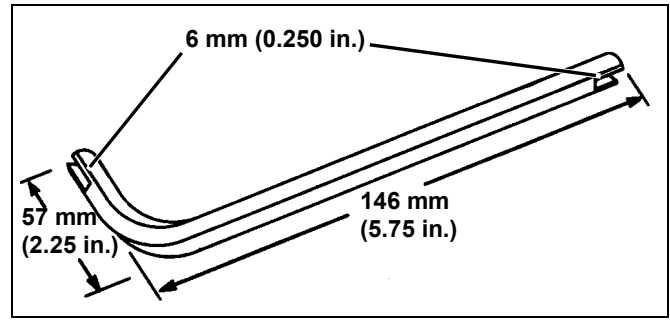

M95238

Picture Note: A tool can be made from a 5/16 in. Allen wrench. Slots are cut into each end 6 mm (0.25 in.) across the width of the wrench.

Specification:

Top No Load rpm 3350 ± 100 rpm

Governed Idle Adjustment

Reason:

To set the governed idle speed.

Equipment:

- JT07270 Pulse Tachometer, or
- JT05719 Digital Tachometer

Procedure:

1. Start engine and run at 1/2 throttle for 5 minutes to bring engine to operating temperature.
2. Move throttle lever to slow position and check engine speed with tachometer.

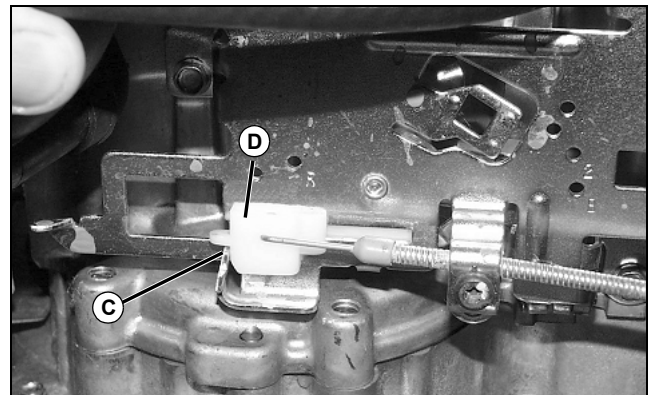

MX38037

3. Tang (C) is a stop for remote control slide (D). If governed idle is not within specification, bend tang (C) to the right to increase rpm or to the left to decrease rpm. Make sure slide is against tab when checking rpms.

Specification:

Governed Idle rpm 2200 ± 300 rpm

ENGINE - GAS TESTS AND ADJUSTMENTS

Slow Idle Carburetor Adjustment

Reason:

To set the carburetor mixture screw for proper operation of the carburetor.

Equipment:

- JT07270 Pulse Tachometer, or
- JT05719 Digital Tachometer

Important: Avoid Damage! To obtain correct adjustment, the procedure must be performed in the sequence shown.

Procedure:

Important: Avoid Damage! When servicing engine (with engine running), remove hood to avoid damage from muffler exhaust heat.

1. Remove hood assembly. "Hood Removal and Installation" on page 309 in the Miscellaneous section.
2. Start engine. Run at 1/2 throttle for 5 minutes to bring engine to operating temperature.
3. Move throttle to SLOW.

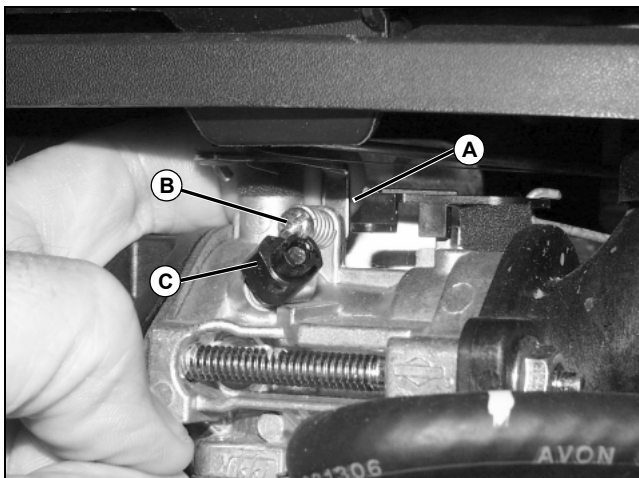

MX38042

4. Hold throttle closed so that tab (A) is against idle speed screw (B). Turn idle speed screw (B) to obtain 1750 rpm.
5. Adjust idle mixture screw (C) slowly until best idle is obtained.
6. Check rpms and re adjust if necessary.

Specification:

Carburetor Slow Idle Speed. 1750 ± 50 rpm

Valve Clearance Adjustment

Note: Correct position of crankshaft is necessary to eliminate interference by the compression release mechanism when adjusting valve clearance.

Procedure:

1. Park machine safely and allow engine to cool.

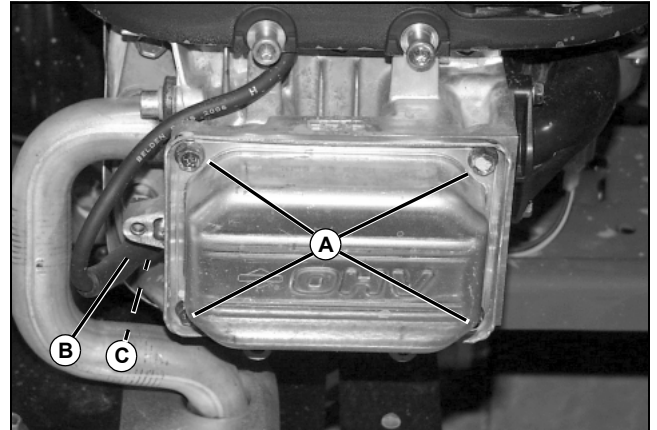

MX38043

2. Remove four bolts and valve cover (A).
3. Disconnect spark plug wire (B) and remove spark plug (C).
4. Place thumb or finger over spark plug hole and turn crankshaft (clockwise viewed from top, counter clockwise viewed from bottom) until air pressure is felt in spark plug hole (engine is on compression stroke).

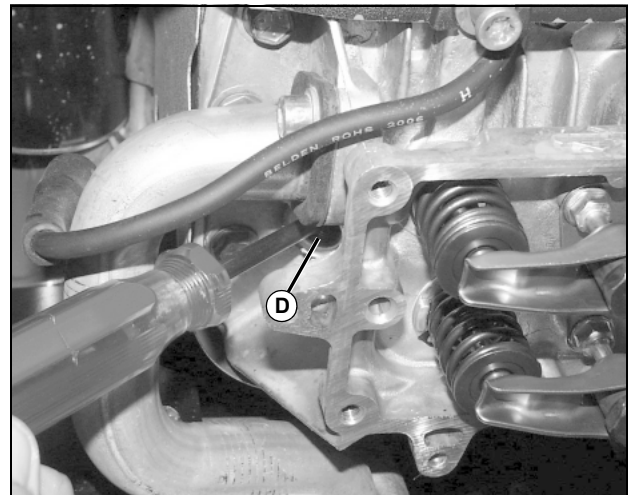

MX38044

5. Insert a screwdriver through the spark plug opening (D). Slowly continue to turn the crankshaft until the piston has pushed the screwdriver to the top of it's stroke and has started to move down again approximately 6.35 mm (0.25 in.).

ENGINE - GAS TESTS AND ADJUSTMENTS

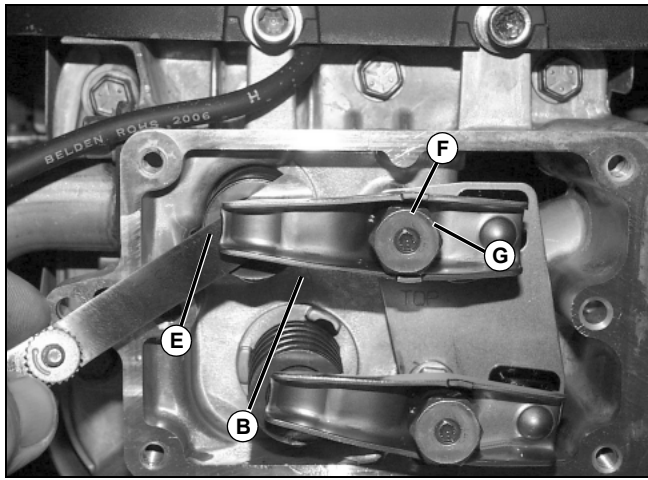

MX38045

6. Check valve clearance with a feeler gauge (E) between valve stem and rocker arm. Valve clearance should be **0.08 - 0.13 mm (0.003 - 0.005 in.)** for the intake (bottom) valve, and **0.13 - 0.18 mm (0.005 - 0.007 in.)** for the exhaust (top) valve.

7. If not within specification, adjust as necessary by loosening set screw (F) and adjusting nut (G) until slight drag is felt on feeler gauge. Hold nut with wrench and tighten set screw to **7 N•m (60 lb-in.)**.

8. Recheck clearance and make adjustments if necessary.

9. Install spark plug. Torque to **20 N•m (180 lb-in.)**.

10. Install valve cover with new gasket. Torque screws to **7 N•m (60 lb - in.)**.

Specifications:

Lock Nut **7 N•m (60 lb - in.)**

Valve Clearance

Intake **0.08 - 0.13 mm (0.003 - 0.005 in.)**

Exhaust **0.13 - 0.18 mm (0.005 - 0.007 in.)**

Valve Cover Cap Screws **7 N•m (60 lb - in.)**

Spark Plug Torque **20 N•m (180 lb - in.)**

Armature Air Gap Adjustment

Reason:

To set the ignition air gap for proper operation.

Equipment:

- 0.30 mm (0.012 in.) Thickness Gauge

Procedure:

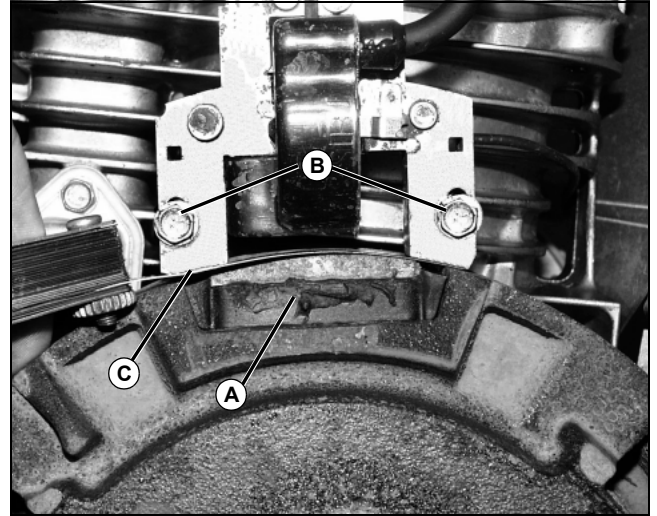

MX38369

1. Remove blower housing.

2. Rotate flywheel until magnet (A) is away from armature.

3. Loosen the armature mounting screws (B). Slide armature away from flywheel as far as possible.

4. Tighten one screw enough to hold the armature in place.

5. Rotate flywheel until magnet is directly under armature.

6. Place a **0.30 mm (0.012 in.)** thickness gauge (C) between armature and magnet.

7. Loosen the mounting screw so magnet will pull armature against thickness gauge.

8. Tighten both mounting screws (B) to specification.

9. Rotate flywheel while pulling thickness gauge out from between the armature and the magnet.

Specification:

Armature Air Gap **0.25 - 0.35 mm (0.010 - 0.014 in.)**

Armature Mounting Screws **2.8 N•m (25 lb-in.)**

ENGINE - GAS TESTS AND ADJUSTMENTS

Crankcase Vacuum Test

Reason:

To determine operation of breather, condition of seals, gaskets, rings, piston, and cylinder wall.

Equipment:

- JTO3503 Vacuum Gauge
- JTO5703 Barb Fitting
- JTO5699 Line
- 8741-F66 Plug

Procedure:

1. Park machine safely
2. Raise hood and remove oil dipstick.
3. Place plug and barbed fitting in dipstick tube until tight.
4. Cover barbed fitting with a plug or finger and start engine.
5. Quickly remove plug or finger from barbed fitting and attach hose and gauge.
6. Run engine at fast idle and record reading on gauge.
7. Run engine at slow idle. Do not turn engine off.
8. Disconnect hose and quickly place plug or finger over barbed fitting.
9. Turn engine off.
10. Remove plug and install oil dipstick.

Results:

If crankcase vacuum is less than specification, check:

- breather reed valve clearance and condition.
- seals and gaskets for leakage.
- valve cover gasket for leakage.
- rings, piston and cylinder wall for wear or damage.
- valve and valve seats for wear or damage.
- head warp.

Crankcase Vacuum (minimum):

Water Movement 25.4 cm (10 in.)
Hg (mercury) Movement 18.7 mm (0.74 in.)

Cylinder Leakdown Test

Reason:

To check sealing of piston rings and cylinder bore.

Equipment:

- JTO3502 Cylinder Leak Tester

Procedure:

1. Remove hood assembly. "Hood Removal and Installation" on page 309 in the Miscellaneous section.



Caution: Avoid Injury! Engine will be HOT. Do not touch with bare skin, especially the exhaust pipe or muffler while making test.

2. Warm engine to operating temperature, then stop engine.
3. Move transaxle shift lever to NEUTRAL. Lock park brake.



MX9745

4. Remove the flywheel screen. Use a socket with a breaker bar (A) on the flywheel nut to hold the flywheel in position when performing the test.



Caution: Avoid Injury! Before attaching adapter hose (F) hose to tester, make sure another person is holding on tight to the breaker bar and the engine is at TDC. When compressed air is applied, there will be considerable torque forcing piston and crankshaft to turn.

ENGINE - GAS REPAIR

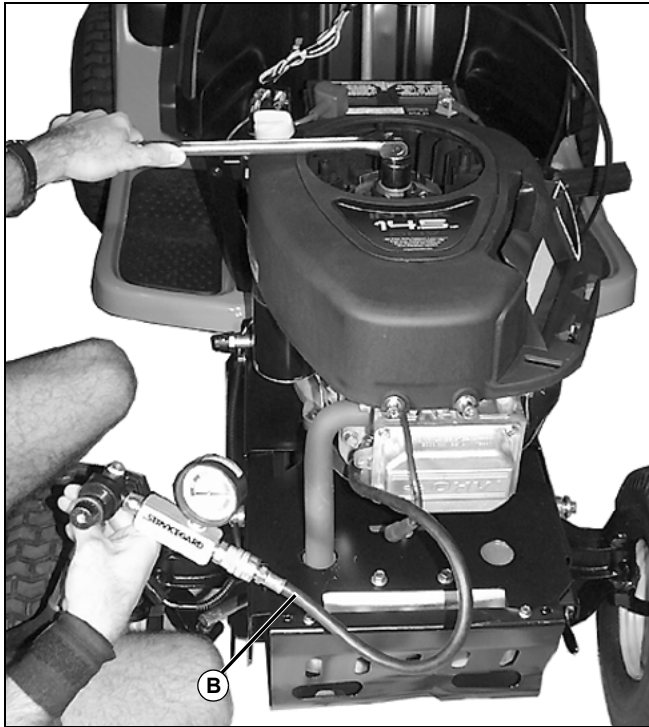

MX9746

5. Connect adapter hose (B) to tester. Watch and record gauge reading while listening for air leaks at carburetor inlet and exhaust outlet. Pressure should hold steady or reduce only slightly.
6. Remove test equipment and install spark plug. Tighten spark plug to **20 N•m (180 lb-in.)**.
7. Install hood.

Results:

Note: *A small amount of air escaping from the crankcase breather is normal.*

- Excessive air escaping from the crankcase breather indicates worn piston rings or cylinder wall, or a leaking head gasket.
- Air escaping from the carburetor indicates a worn intake valve or seat.
- Air escaping from the exhaust pipe indicates a worn exhaust valve or seat.
- Gauge reading in the Green (low) area indicates good compression. (Less than 25% is considered normal.)
- Gauge reading in the Yellow (moderate) area indicates borderline compression. The engine is still usable but an overhaul should be considered.
- Gauge reading in the Red (high) area indicates excessive compression loss. Engine overhaul is necessary.

Repair

Upper Blower Housing Removal and Installation

Procedure:

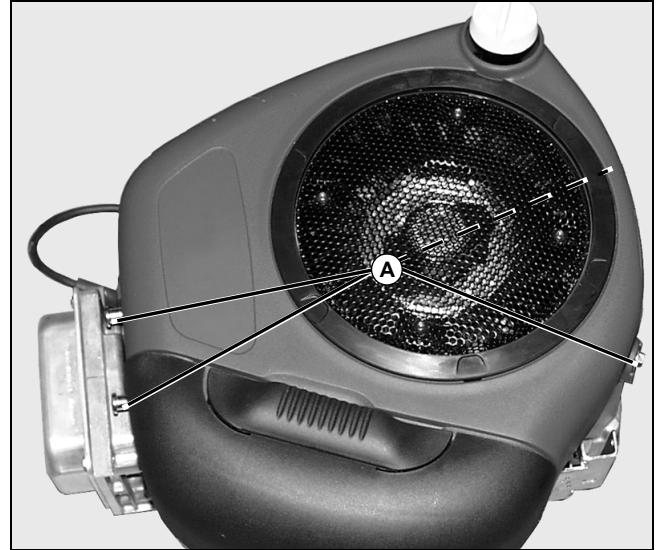

MX9660

1. Remove four screws (A) holding the outer blower housing in place.
2. Lift outer blower housing up and off of engine.
3. Remove the screw holding the dipstick tube in place.
4. Install in reverse order of removal.

Specification:

Blower Housing Screws 10 N•m (85 lb-in.)

Air Cleaner Service

Procedure:

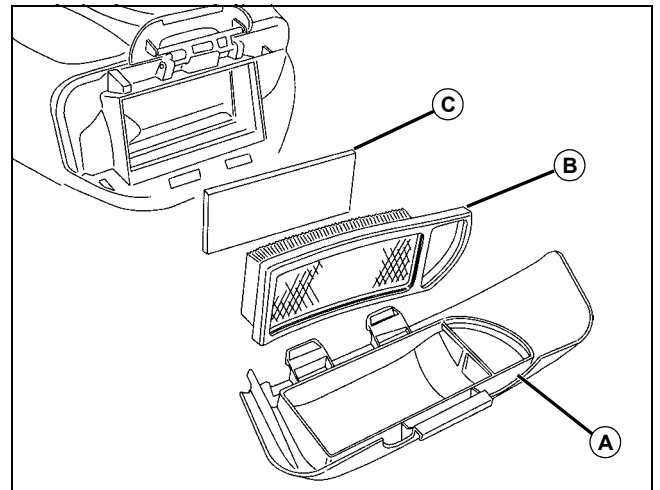



Suggest:

If the above button click is invalid.

Please download this document

first, and then click the above link

to download the complete manual.

Thank you so much for reading

ENGINE - GAS REPAIR

MX9653

Important: Avoid Damage! DO NOT use petroleum solvents, such as kerosene, to clean paper cartridge. They may cause cartridge to deteriorate. DO NOT oil paper cartridge. DO NOT use pressurized air to clean or dry paper cartridge.

1. Remove cover (A) to service dual element air cleaner.
2. Remove cartridge (B) and foam pre-cleaner (C).
3. Wash pre-cleaner in liquid detergent and water and squeeze it dry in a clean cloth. Saturate it in engine oil. Wrap it in a clean absorbent cloth and squeeze to remove excess oil.
4. Clean cartridge by tapping gently on a flat surface. Replace if dirty.
5. Reinstall pre-cleaner, cartridge, and cover.

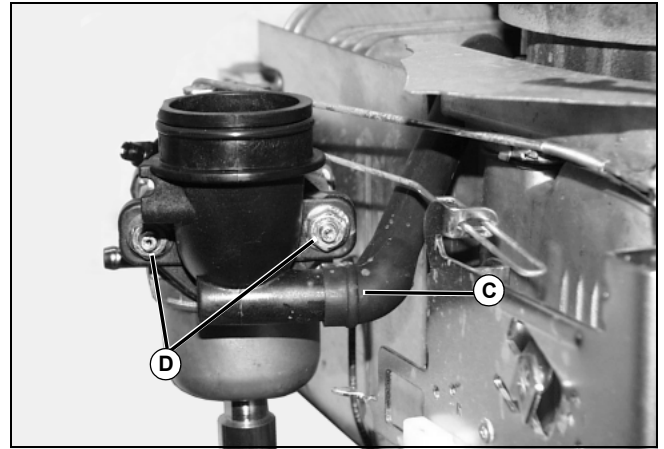

MX38560

5. Disconnect the breather tube (C). Remove two nuts (D) securing the air cleaner base.

Carburetor Removal and Installation

Removal:

1. Park machine safely.

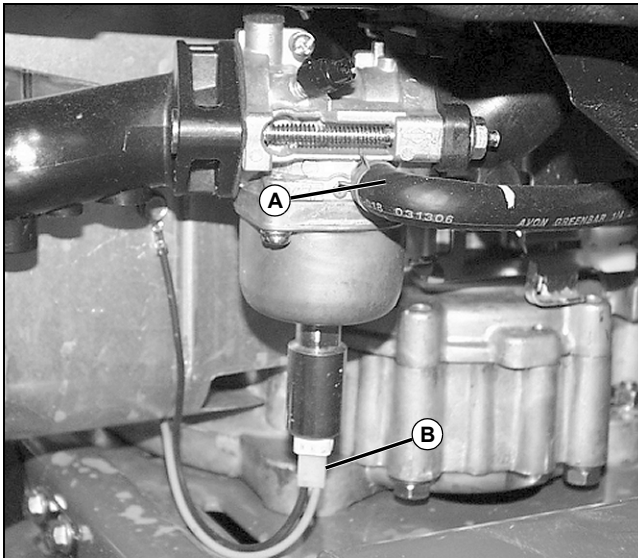

MX38562

2. Disconnect fuel line (A) and drain fuel in line into an approved container.
3. Disconnect wires (B) to fuel shutoff solenoid.
4. Remove blower housing and air cleaner assembly. See "Upper Blower Housing Removal and Installation" on page 29

! Caution: Avoid Injury! Gasoline is extremely flammable. Do not smoke. Always work in a well ventilated area away from open flame or spark producing equipment; including equipment that utilizes pilot lights.

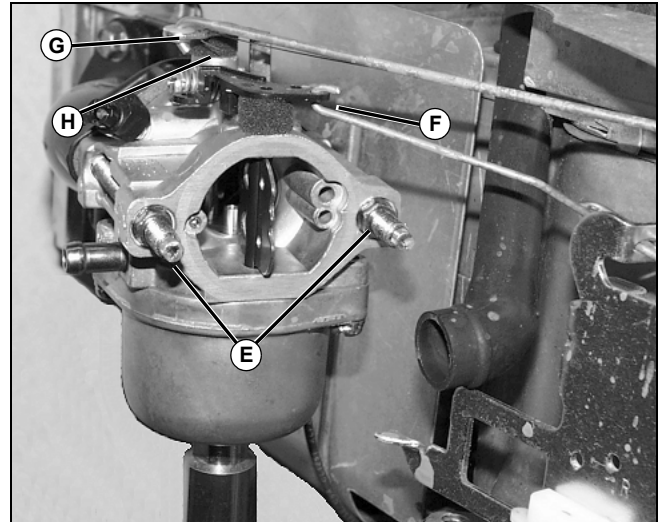

MX38561

6. While supporting the carburetor in one hand, loosen and remove the two studs (E) holding the carburetor to the intake manifold.
7. Carefully pull the carburetor away from the intake manifold and rotate the carburetor to disengage the choke linkage (F), governor link (G) and governor link spring (H).
8. Remove carburetor and gasket.

<https://www.ebooklibonline.com>

Hello dear friend!

Thank you very much for reading.

Enter the link into your browser.

The full manual is available for immediate download.

<https://www.ebooklibonline.com>