

JD644C Loader JD646C Compactor

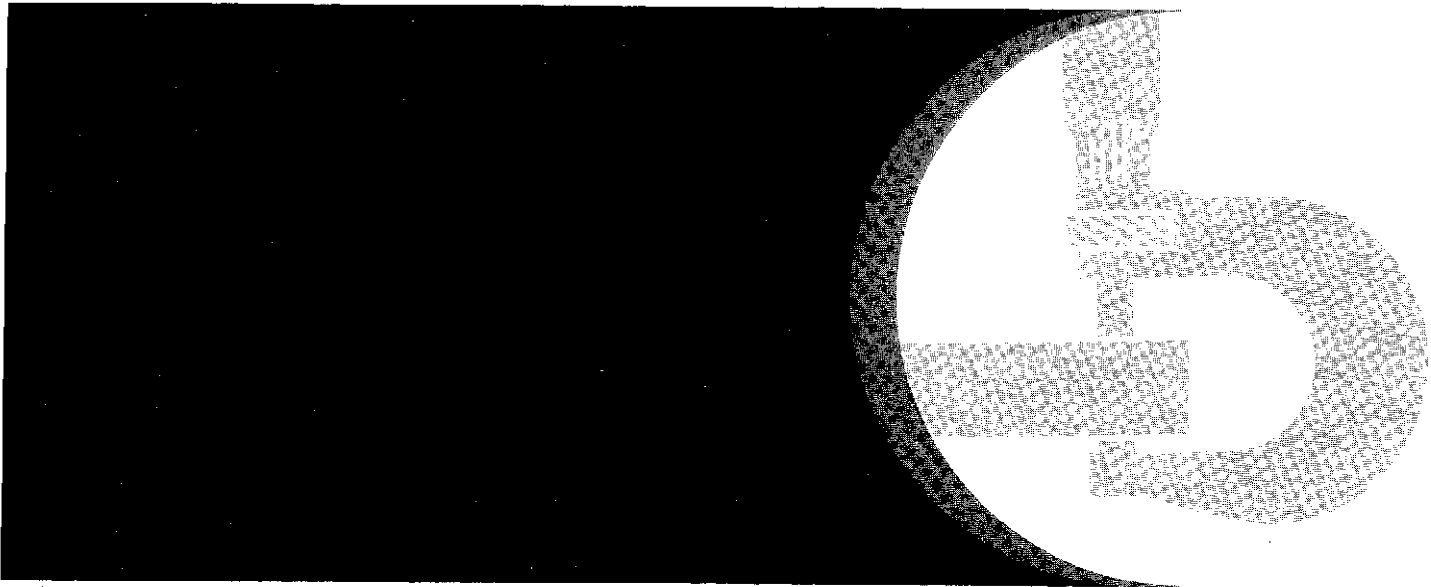

TECHNICAL MANUAL

644C LOADER AND 646C COMPACTOR TECHNICAL MANUAL TM-1229 (MAR-84)

SECTION AND GROUP CONTENTS

SECTION I—GENERAL INFORMATION

- Group I—Introduction and Safety Information
- Group II—General Specifications
- Group III—Torque Values
- Group IV—Fuels and Lubricants

SECTION 01—WHEELS

- Group 0110—Powered Wheels and Fastenings

SECTION 02—AXLES AND SUSPENSION SYSTEMS

- Group 0200—Removal and Installation
- Group 0210—Differential or Bevel Drive
- Group 0225—Input Drive Shafts and U-Joints
- Group 0250—Axle Shafts, Bearings and Reduction Gears
- Group 0260—Hydraulic Systems

SECTION 03—TRANSMISSION

- Group 0300—Removal and Installation
- Group 0315—Controls
- Group 0325—Input Drive Shafts and U-Joints
- Group 0350—Gears, Shafts, Bearings and Power Shift Clutch
- Group 0360—Hydraulic System

SECTION 04—ENGINE

- Group 0400—Engine Removal and Installation
- Group 0401—Crankshaft and Main Bearings
- Group 0402—Camshaft and Valve Actuating Means
- Group 0403—Connecting Rods and Pistons
- Group 0404—Cylinder Block

SECTION 04—ENGINE—Continued

- Group 0407—Oiling System
- Group 0408—Ventilating System
- Group 0409—Cylinder Head and Valves
- Group 0410—Exhaust Manifold
- Group 0413—Fuel Injection System
- Group 0414—Intake Manifold
- Group 0416—Turbocharger
- Group 0417—Water Pump
- Group 0418—Thermostats, Housings and Piping
- Group 0419—Oil Cooler
- Group 0420—Fuel Filter
- Group 0422—Starting Motor and Fastenings
- Group 0429—Fan Drive
- Group 0433—Flywheel, Housing and Fastenings

SECTION 05—ENGINE AUXILIARY SYSTEMS

- Group 0505—Cold Weather Starting Aids
- Group 0510—Cooling Systems
- Group 0515—Speed Controls
- Group 0520—Intake System
- Group 0530—External Exhaust Systems
- Group 0540—Mounting Frame
- Group 0560—External Fuel Supply Systems

SECTION 06—TORQUE CONVERTER

- Group 0651—Turbine, Gears, Shafts and Bearings

All information, illustrations and specifications contained in this technical manual are based on the latest information available at the time of publication. The right is reserved to make changes at any time without notice. Wherever applicable, specifications and design information are in accordance with SAE and ICED standards.

COPYRIGHT© 1984
DEERE & COMPANY
Moline, Illinois
All rights reserved
A JOHN DEERE ILLUSTRATION
Previous Edition
Copyright© 1983 Deere & Company
Copyright© 1982 Deere & Company
Copyright© 1980 Deere & Company

T09:1229 01 150384

SECTION AND GROUP CONTENTS—CONTINUED

SECTION 09—STEERING SYSTEM

- Group 0930—Emergency Steering
- Group 0960—Hydraulic System

SECTION 10—SERVICE BRAKES

- Group 1011—Active Elements
- Group 1015—Controls Linkage
- Group 1060—Hydraulic System

SECTION 11—PARKING-EMERGENCY BRAKES

- Group 1111—Active Elements
- Group 1115—Controls Linkage

SECTION 16—ELECTRICAL SYSTEMS

- Group 1671—Batteries, Support and Cables
- Group 1672—Alternator, Regulator and Charging System Wiring
- Group 1673—Lighting System
- Group 1674—Wiring Harness and Switches
- Group 1675—System Controls
- Group 1676—Instruments and Indicators

SECTION 17—FRAME, CHASSIS, OR SUPPORTING STRUCTURE

- Group 1740—Frame Installation
- Group 1746—Frame Bottom Guards
- Group 1749—Chassis Weights

SECTION 18—OPERATOR'S STATION

- Group 1800—Removal and Installation
- Group 1810—Operator Enclosure
- Group 1821—Seat and Seat Belt
- Group 1830—Heating and Air Conditioning

SECTION 19—SHEET METAL AND STYLING

- Group 1910—Hood or Engine Enclosure
- Group 1921—Grille and Grille Housing
- Group 1927—Fenders

SECTION 20—SAFETY, CONVENIENCE AND MISCELLANEOUS

- Group 2002—Mirror
- Group 2003—Fire Extinguisher
- Group 2004—Horn and Warning Devices
- Group 2006—Cigar Lighter

SECTION 21—MAIN HYDRAULIC SYSTEM

- Group 2160—Hydraulic System

SECTION 31—LOADER

- Group 3102—Buckets
- Group 3115—Controls Linkage
- Group 3140—Frames
- Group 3160—Hydraulic System

SECTION 90—SYSTEM TESTING

- Group 9005—General Information—Seven Basic Steps of Diagnosis and Testing
- Group 9010—Engine
- Group 9015—Electrical System
- Group 9020—Power Train
- Group 9025—Hydraulic System
- Group 9031—Heating and Air Conditioning

SECTION 99—SPECIAL TOOLS

INDEX

<https://www.ebooklibonline.com>

Hello dear friend!

Thank you very much for reading.

Enter the link into your browser.

The full manual is available for immediate download.

<https://www.ebooklibonline.com>

INTRODUCTION AND SAFETY INFORMATION**INTRODUCTION**

This technical manual is part of a twin concept of service.

FOS Manuals - for reference**Technical Manuals - for actual service**

The two kinds of manuals work as a team to give you both the general background and technical details of shop service.

Fundamentals of Service (FOS) Manuals cover basic theory of operation, fundamentals of troubleshooting, general maintenance, and basic types of failures and their causes. FOS Manuals are for training new personnel and for reference by experienced technicians.

Technical Manuals are concise service guides for specific machines. Technical manuals are on-the-job guides containing only the vital information needed by an experienced service technician.



30A/T8595B T28: I01 130582

FEATURES OF THIS TECHNICAL MANUAL

- John Deere ILLUSTRATION format emphasizing detailed pictures and fewer words in easy-to-use modules.
- Removal and installation groups preceding some repair groups.
- A section of system diagnostic testing.
- Table of contents of all sections at the front of the manual and a listing of all groups and headings at the front of each section.
- Special tools and specifications listed at the front of each group they are used in.
- Special tools illustrated in numerical order at end of manual.
- Alphabetical listing of all major components, specifications, and special tools.
- Safety rules, general specifications, and lubrication specifications.

This technical manual was planned and written for you - an experienced service technician. Keep it in a permanent binder in the shop where it is handy. Refer to it when you need to know correct service procedures or specifications.

Using the technical manual as a guide will reduce error and costly delay. It will also assure you the best in finished service work.



63A/T8595B T28: I115 150383

SAFETY AND YOU



CAUTION: This safety symbol followed by the word "caution" identifies important safety messages in this manual and on the loader or compactor. When you see this symbol, be alert to the possibility of personal injury and carefully read the message that follows.



T27999N

02A:T27999 N T09:III02 160181

Be prepared if an accident or fire should occur. Know where the first aid kit and the fire extinguishers are located - know how to use them.

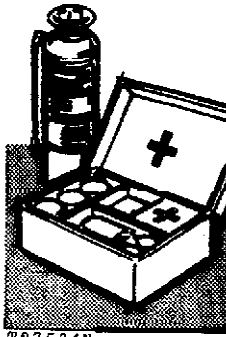

T27504N

02A:T27504 N T09:III03 160181

Wear safety equipment.

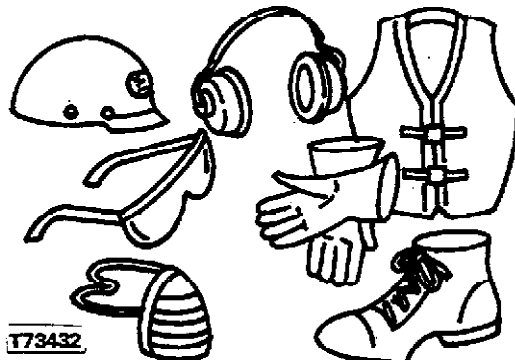

T73432

02A:T73432 T09:III04 160181

Introduction and Safety Information

Wear fairly tight clothing.



T46672

02A;T45672 T09;III05 150384

AVOID HIGH-PRESSURE FLUIDS

Escaping fluid under pressure can penetrate the skin causing serious injury. Relieve pressure before disconnecting hydraulic or other lines. Tighten all connections before applying pressure. Keep hands and body away from pinholes and nozzles which eject fluids under high pressure. Use a piece of cardboard or paper to search for leaks.

If ANY fluid is injected into the skin, it must be surgically removed within a few hours by a doctor familiar with this type injury or gangrene may result.

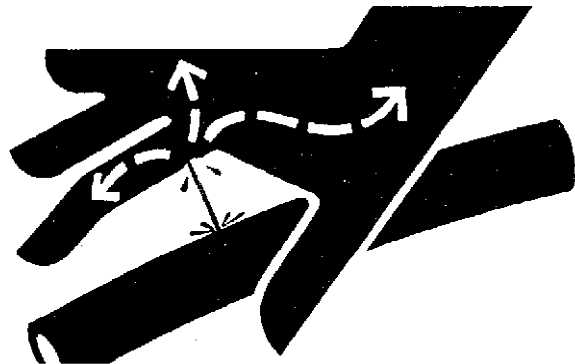

8NA;X9811 T62;BH5A F 120184

KEEP SHOP AND STORAGE AREA CLEAN

Maintenance area should be adequately vented.

Keep maintenance area clean and dry.

Store flammable materials in a cool and well-vented area out of reach of unauthorized personnel.

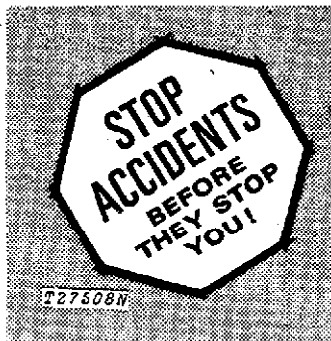

02A;T27508 N T09;III07 160181

FOLLOW SAFE WORKING CONDITIONS

Perform work on equipment only if authorized to do so.

Follow recommended procedures.

Do not service equipment while it is being operated or engine is running.

Always use two service technicians - one, the operator at the controls, the other checking within sight of the operator.

Keep hands away from moving parts.

Support all raised equipment.

Do not work under raised bucket.

Always lower bucket before working on it.

If machine is on an incline, block it securely.

Use hoisting equipment for lifting heavy parts.

Wear safety glasses when drilling, grinding or hammering metal.

Do not use open flame around machine.

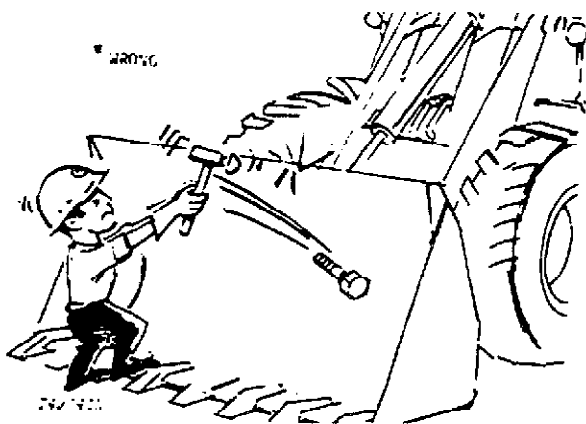

T32709 N, T49041 N T09;I108 190181

START ENGINE FROM OPERATOR'S SEAT ONLY

Avoid possible injury or death from machinery runaway.

Do not start engine by shorting across starter terminals. Machine will start in gear and will move if normal circuitry is bypassed.

NEVER start engine while standing on ground. Start engine only from operator's seat. Move range selector lever to park position or apply park brake.

T82;TL5A N 120184

Removal and Installation

SPECIAL TOOLS

NOTE: Order tools from your SERVICE-GARD™ Catalog, unless otherwise indicated.

Number	Name	Use
D-01182AA	Shop Stands	Supports the unit while removing differentials
or		
D-24206WK		

T09;020001 171280

FRONT DIFFERENTIAL AND AXLE SPECIFICATIONS

- 1. Nuts torque (600 ± 60 N·m) 445 ± 45 lb-ft

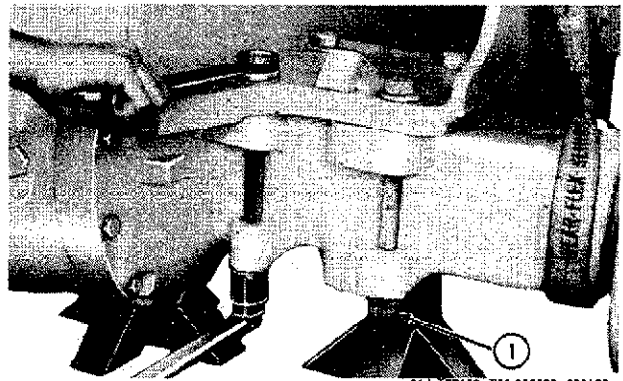

06A:177458 T09:020002 030682

- 2. Cap screws torque (130 ± 7 N·m) 95 ± 5 lb-ft

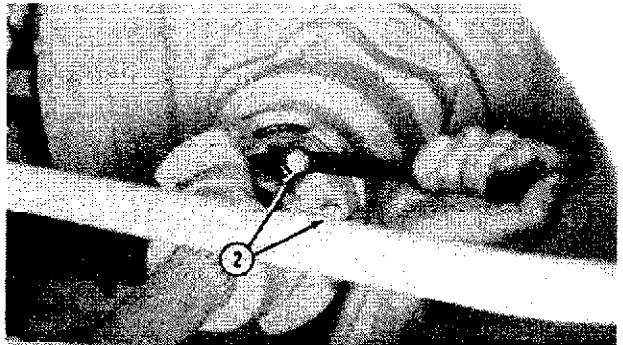

06A:T77460 T09:020003 171280

REAR DIFFERENTIAL AND AXLE SPECIFICATIONS

- 1. Install shims to give an end play clearance of (0.03 to 0.46 mm) 0.001 to 0.018 in.

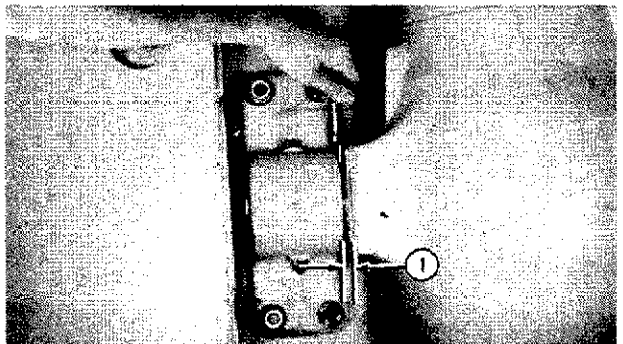

06A:T77394 T09:020004 030682

Removal and Installation

2. Cap screws and nuts torque

5/8 in.	(325 N·m) 240 lb-ft
20 mm	(680 ± 68 N·m) 500 ± 50 lb-ft

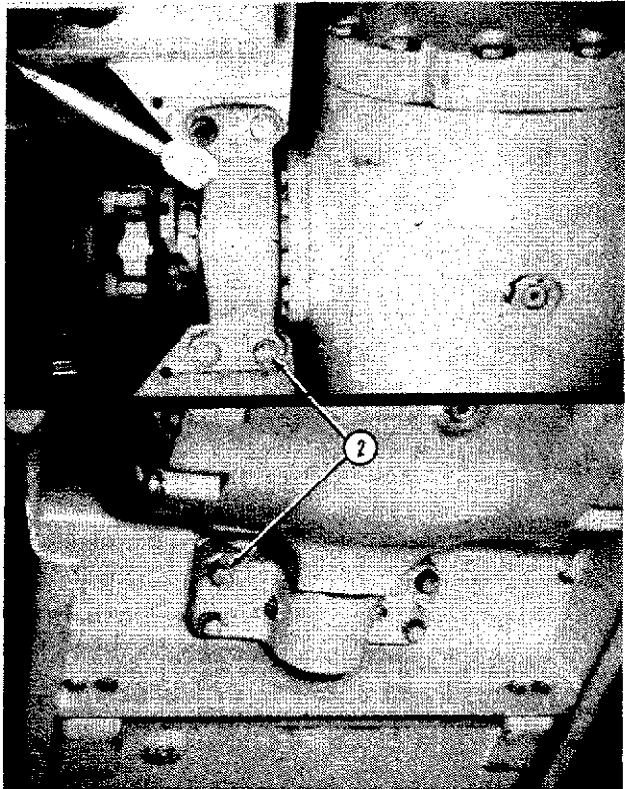

06A,T77459 T09;020005 030682

3. Cap screws torque(130 ± 7 N·m) 95 ± 5 lb-ft

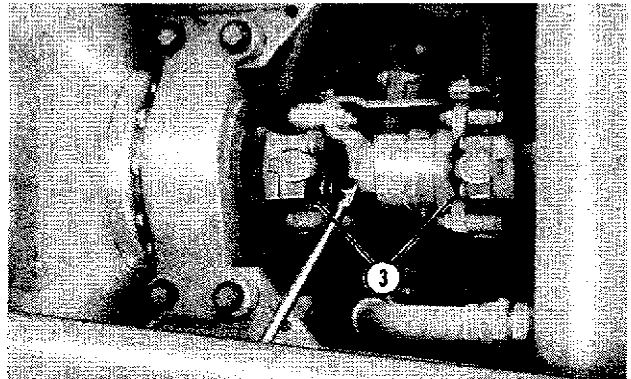

06A,T77402 T09;020006 221280

FRONT AXLE AND DIFFERENTIAL ASSEMBLY - PUT SHOP STANDS UNDER LOADER FRAME

1. Lift loader boom as high as possible. Put a support with a rated capacity of approximately (1772 kg) 3900 lbs. under bucket and boom.
2. Stop the engine.
3. Operate the steering valve, brake valve and loader control valve to release hydraulic pressure in the systems. Put loader control lever into float position.
4. Install lock bar (1).

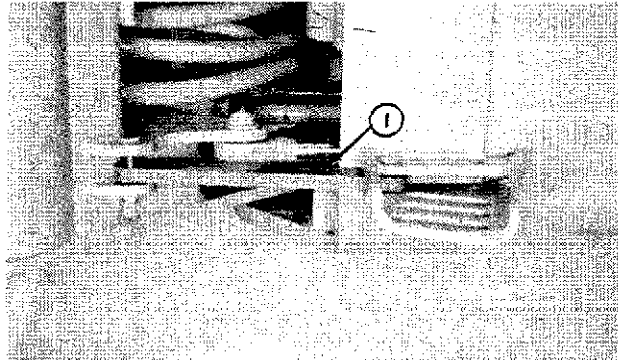

05A175619 T03.020027 221280

5. Disconnect battery ground cables (1).

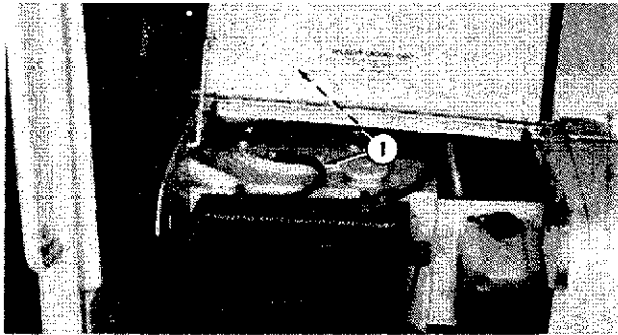

05A175215 103.020008 171260

6. Using a service jack under the front bottom guard, remove nuts and lower the bottom guard (if equipped).

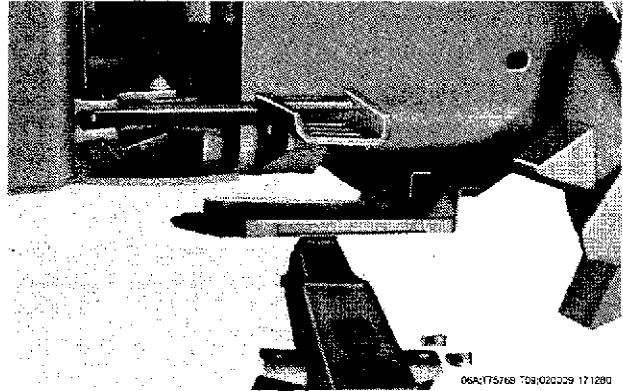

05A175768 T03.020029 171280

7. Fasten a chain hoist (1) to the loader frame hooks and lift the front of the machine.
8. Put D-00182AA (shown) or D-24206WK Shop Stands (2) under loader frame. Lower machine onto shop stands.
9. Remove wheels (Group 0110).

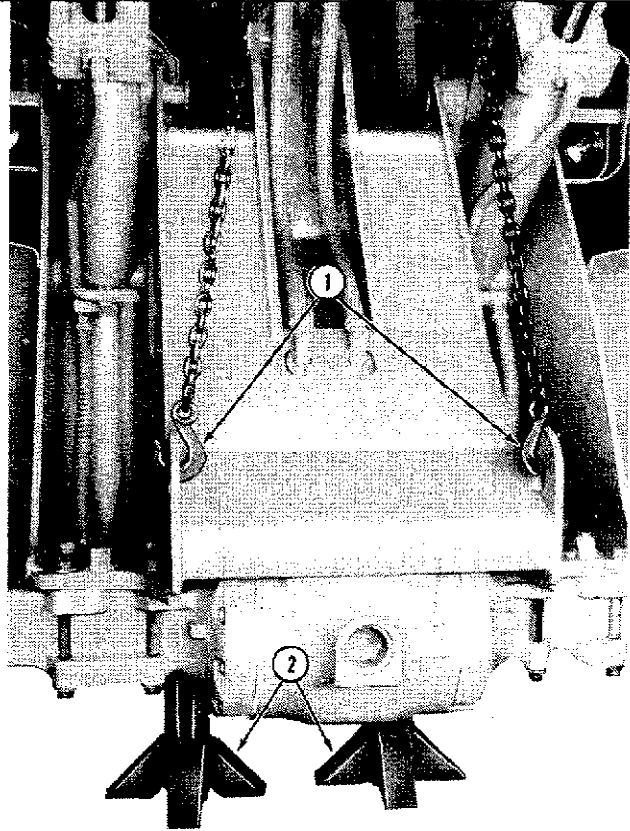

06A:T77460 T09:020010 171280

DISCONNECT HYDRAULIC LINES AND DRIVE SHAFT



CAUTION: Escaping hydraulic oil under pressure can have sufficient force to penetrate the skin, causing serious injury. Before disconnecting lines, be sure to relieve pressure. Before applying pressure, be sure connections are tight and lines, pipes, and hoses are not damaged. Use a piece of cardboard or wood, rather than hands, to search for leaks.

If injured by escaping oil, see a doctor at once. Serious infection or reaction can develop if proper medical treatment is not administered immediately.

1. Disconnect hydraulic brake line (1) and differential lock return hose (2).

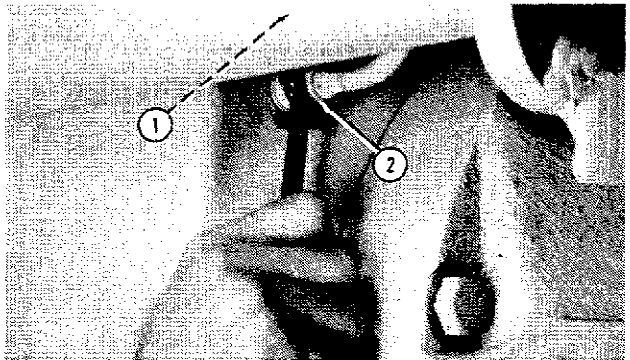

06A:T77461 T09:020011 240383

Removal and Installation

2. Disconnect differential lock inlet line (1).
3. Close all openings with caps and plugs to keep dirt from entering the hydraulic system.
4. Remove four cap screws (2) to disconnect drive shaft from input quill.

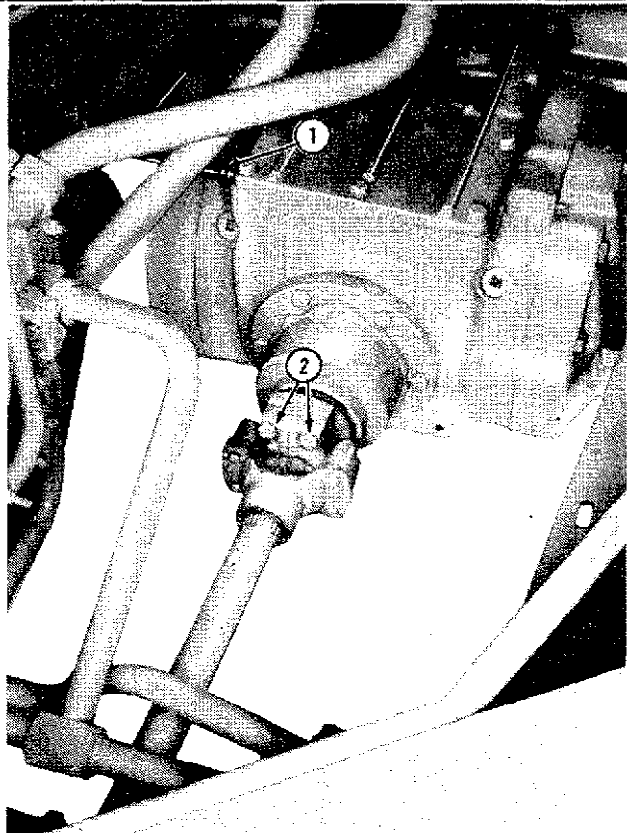

06A:T75216 TC9:020012 240283

LOWER DIFFERENTIAL AND AXLE ASSEMBLY

1. Remove drain plug to drain approximately (22.5 L) 6 gal. of oil from differential.
2. Put a lifting strap (1) around each axle housing.

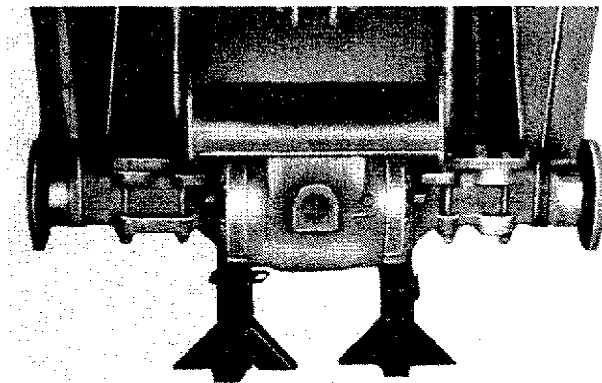

06A:T77462 T09:020013 030682

3. Put tension on straps and remove eight bolts and nuts.

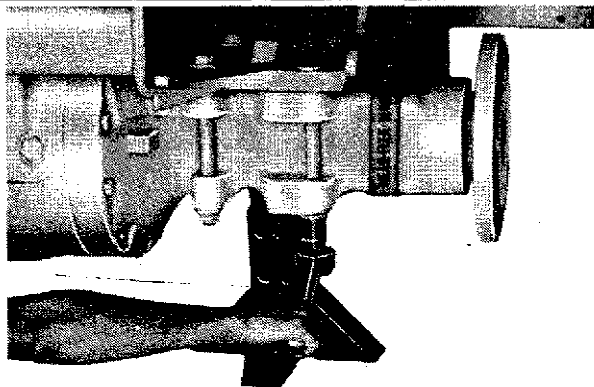

06A:T77463 T09:020014 171280

Removal and Installation

4. Lower axle and differential as an assembly.

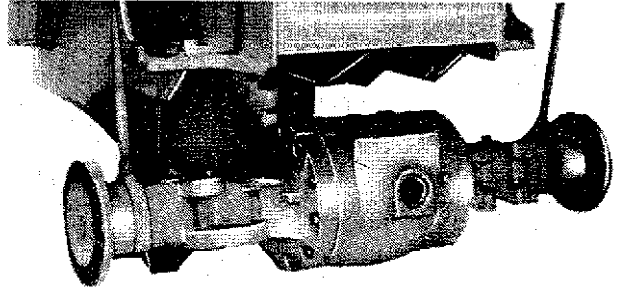

06A:T77464 T09:020015 171260

INSTALL DIFFERENTIAL AND AXLE ASSEMBLY

1. Lift axle and differential assembly in loader frame.
2. Install eight bolts, 16 washers and eight nuts (1). Tighten nuts to $(600 \pm 60 \text{ N}\cdot\text{m})$ $445 \pm 45 \text{ lb}\cdot\text{ft}$.

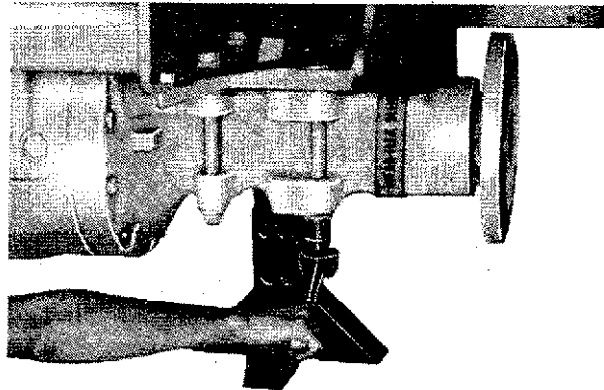

06A:T77463 T09:020016 171260

CONNECT DRIVE SHAFT AND HYDRAULIC LINES

1. Connect drive shaft and fasten with cap screws (2). Tighten cap screws to $(130 \pm 13 \text{ N}\cdot\text{m})$ $95 \pm 5 \text{ lb}\cdot\text{ft}$.
2. Connect differential lock inlet line (1).

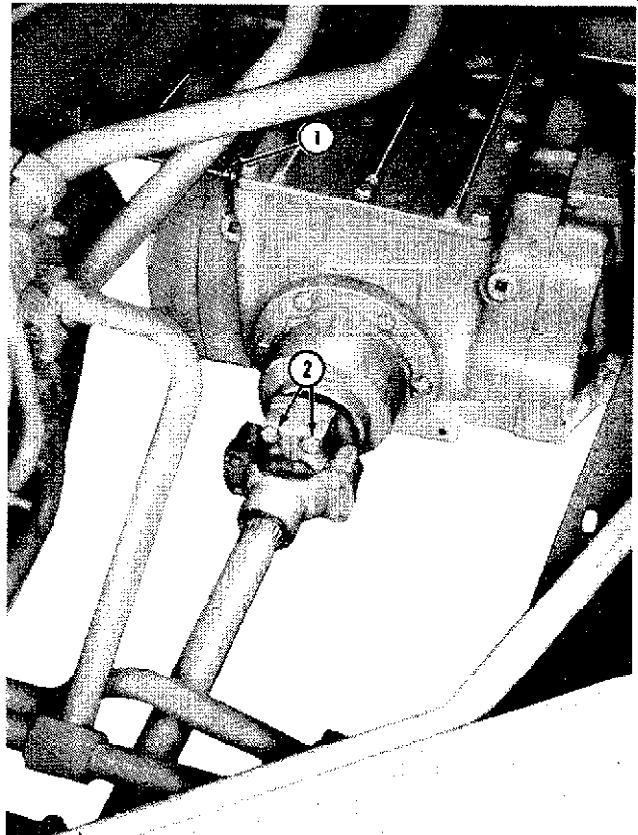

06A:T75216 T09:020017 240283

Removal and Installation

3. Connect hydraulic brake line (1) and return hose (2).

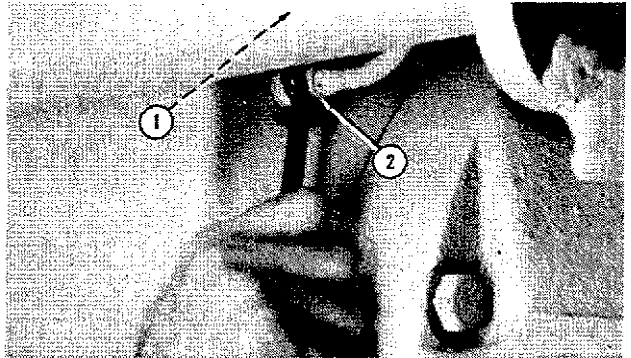

06A;177461 T09;020018 240283

REMOVE SHOP STANDS

1. Install wheels (Group 0110).
2. Lift loader frame with chain hoist (1) and remove shop stands (2).

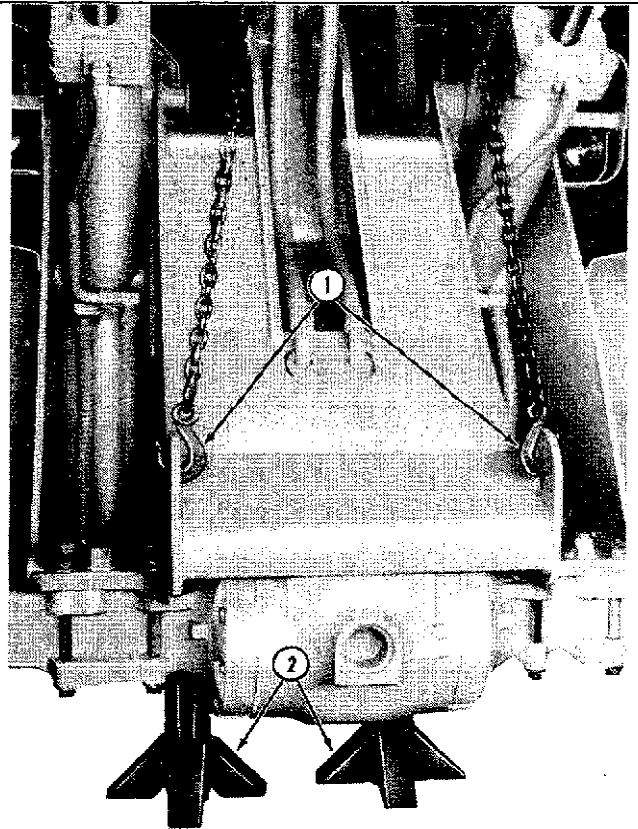

06A;177460 T09;020019 171280

FILL DIFFERENTIAL WITH OIL

1. Install drain plug.
2. Fill the front differential SLOWLY with recommended oil to fill plug level. See Section I, Group IV for the type of oil used. Let the unit stand for approximately one minute and check the differential oil level. Add more oil if necessary.
3. Connect battery cables, start the engine and lower boom and bucket assembly.
4. Bleed brake hydraulic system (Group 1060).

T09;020020 240283

**REAR AXLE AND DIFFERENTIAL ASSEMBLY
- PUT SHOP STANDS UNDER ENGINE
FRAME**

1. Lower all equipment to the ground.
2. Stop the engine.
3. Operate the steering valve, brake valve and loader control valve to release hydraulic pressure in the systems.
4. Install lock bar (1).

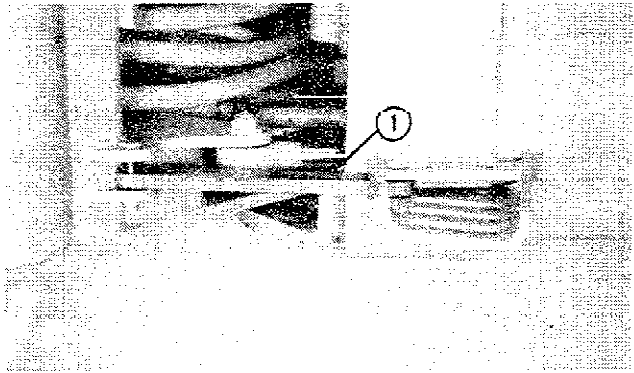

06A:775019 T09:020024 171280

5. Disconnect battery ground cables (1).
6. Remove center bottom guard (if equipped).

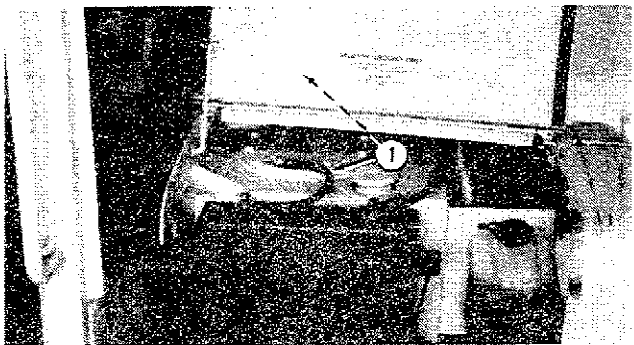

06A:775215 T09:020025 171280

7. Lift the rear of unit and put D-24206WK (shown) or D-01182AA Shop Stands under engine frame.
8. Put lifting straps around each axle housing and put equal tension on straps.
9. Remove wheels (Group 0110).

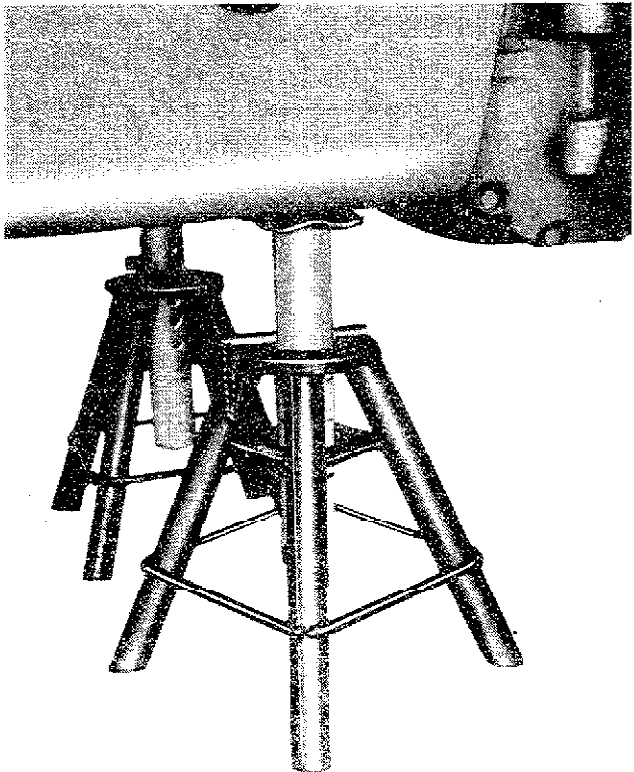

06A:775665 T09:020026 171280

DISCONNECT BRAKE LINE

NOTE: View looking down left side of engine.

CAUTION: Escaping hydraulic oil under pressure can have sufficient force to penetrate the skin, causing serious injury. Before disconnecting lines, be sure to relieve pressure. Before applying pressure, be sure connections are tight and lines, pipes, and hoses are not damaged. Use a piece of cardboard or wood, rather than hands, to search for leaks.

If injured by escaping oil, see a doctor at once. Serious infection or reaction can develop if proper medical treatment is not administered immediately.

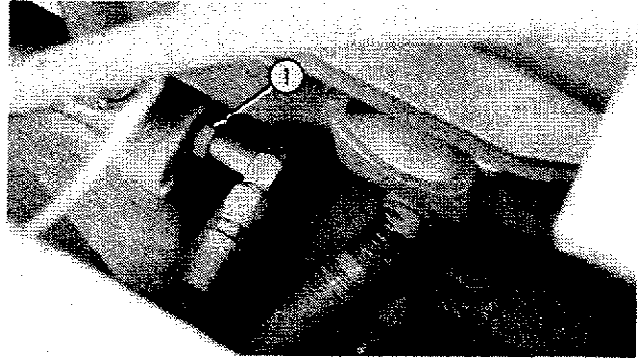

1—Brake Line

05A:T77466 T09:02027 221280

LOWER DIFFERENTIAL AND AXLE ASSEMBLY

1. Remove drain plug (1) to drain approximately (22.5 L) 6 gal. of oil from differential.

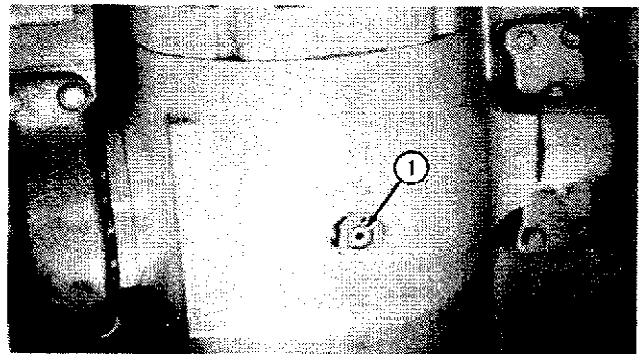

05A:T77457 T09:02028 171290

2. Remove four cap screws to disconnect rear differential drive line.

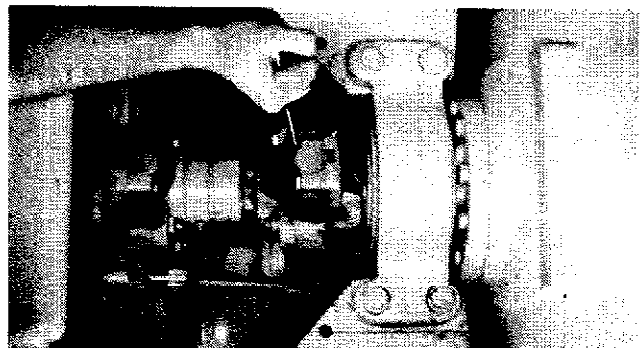

05A:T77458 T09:02023 171280

Removal and Installation

3. Remove four cap screws and nuts from front oscillating support.

4. Disconnect oscillating grease line (2) from fitting.

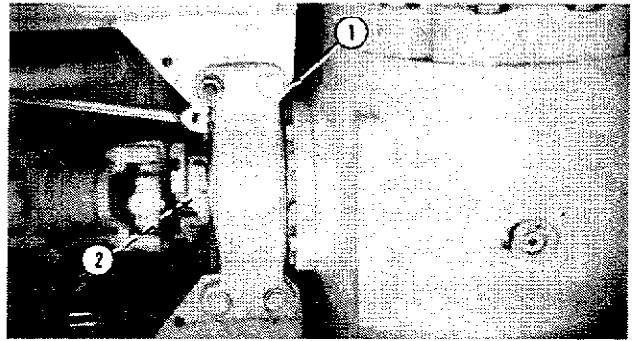

05A:T77469 T09:020030 171280

5. Disconnect oscillating pin grease line (1).

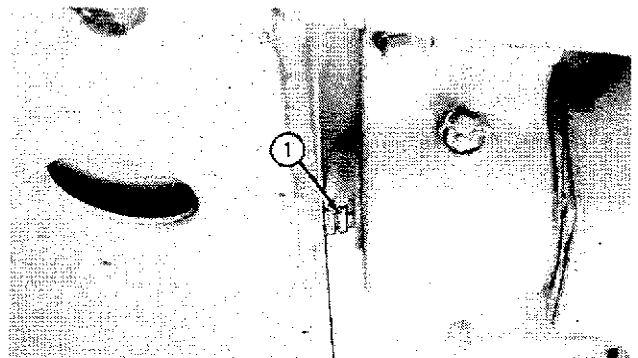

05A:T77470 T09:020031 171260

6. Remove four cap screws and nuts from rear support.

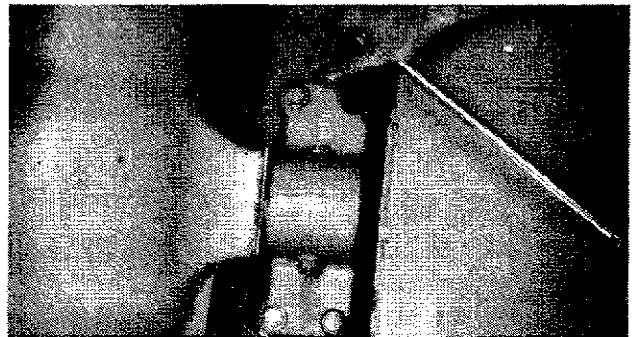

05A:T77472 T09:020032 172280

7. Lower axle and differential as an assembly.

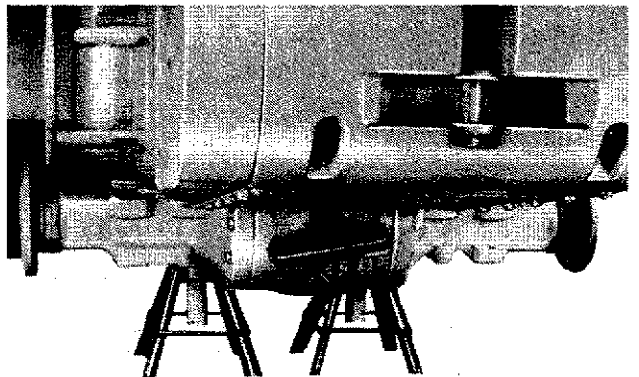

05A:T77473 T30:020033 171280

INSTALL DIFFERENTIAL AND AXLE ASSEMBLY

1. Before installing differential assembly, remove O-ring (1).
2. Install rear support assembly with front thrust plate (2) on dowel pin. Install rear thrust plate (3) with straight edge of plate up. Grease grooves in thrust plates must face each other. DO NOT install any shims.

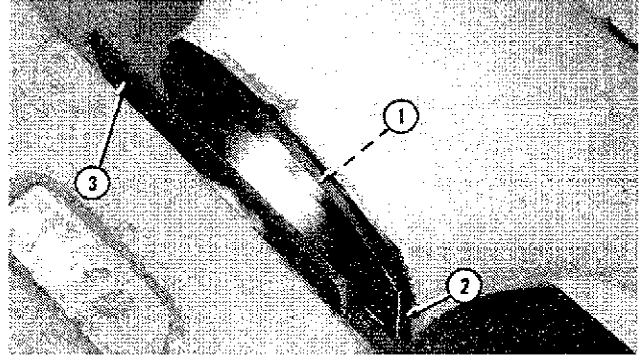

06A:T77474 T09:020094 090682

3. Lift axle and differential assembly in engine frame.

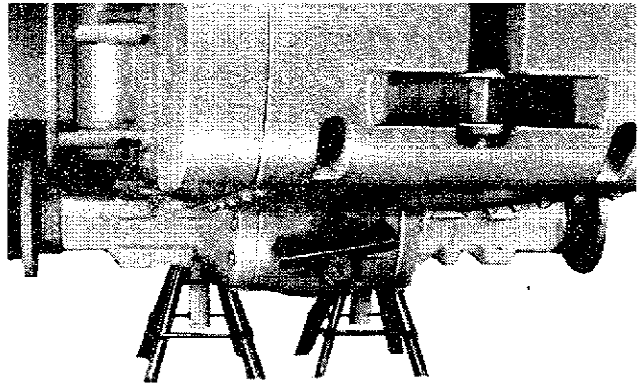

06A:T77473 T09:020035 171280

ADJUST DIFFERENTIAL AND AXLE ASSEMBLY

1. Install and tighten only two cap screws and nuts (1) in both front and rear support.
2. With a pry bar, move the differential and axle assembly as far forward as possible.

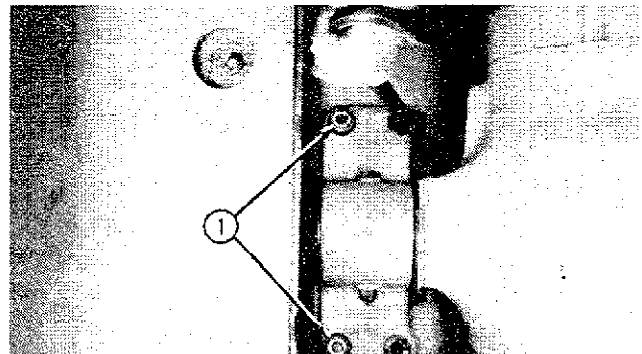

06A:T77475 T09:020036 221280

3. With a feeler gauge, measure the clearance (1) between the rear thrust plate and support.

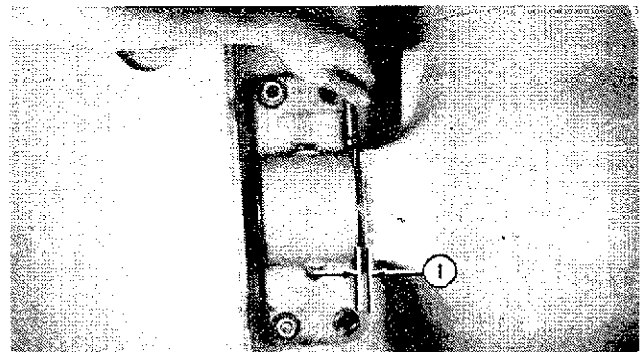

06A:T77394 T09:020037 171280

Removal and Installation

4. Measure the thickness of feeler gauge blades.

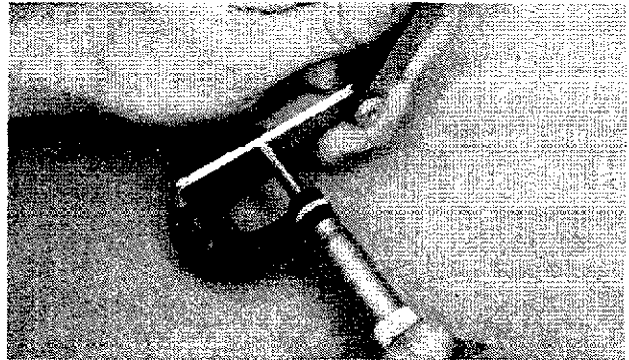

06A:T77476 T09:020038 171280

5. Measure each shim separately to equal a shim pack thickness which will give an end play clearance of (0.03 to 0.46 mm) 0.001 to 0.018 in.

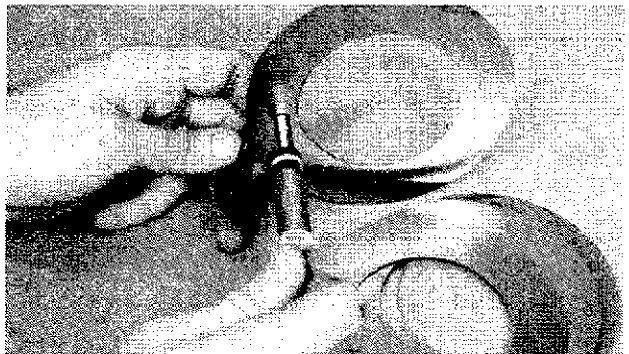

06A:T77477 T09:020039 030682

6. Lower differential and axle assembly and remove support.

7. Install O-ring (2) and shim pack (1). Install shims between rear thrust plate and support.

8. Install support.

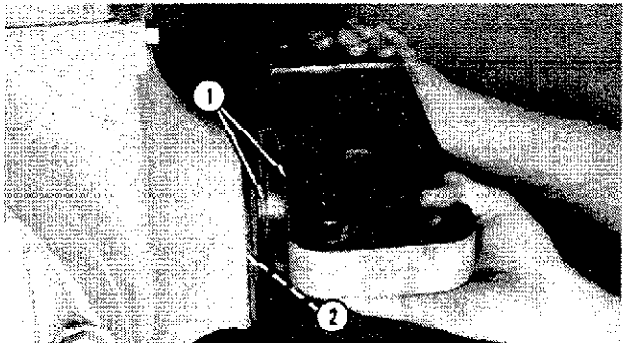

06A:T77478 T09:020040 171280

FASTEN FRONT AND REAR SUPPORT

1. Install dowels (1) in rear support.

2. Put T43515 John Deere Loctite® retaining compound or an equivalent on mounting surface of support.

Loctite is a trademark of the Loctite Corp.

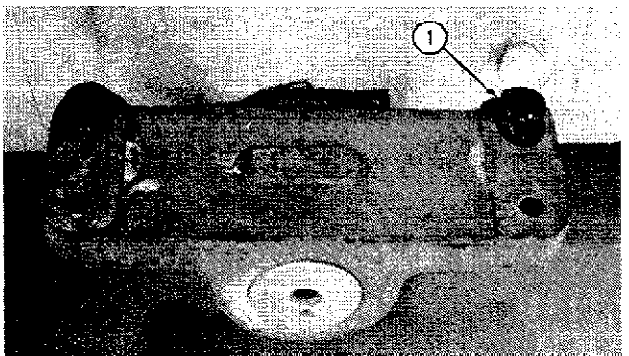

06A:T77479 T09:020041 221280

Removal and Installation

3. Install dowels (1) in front support.
4. Make sure fitting (2) is positioned as shown.
5. Put T43515 John Deere Loctite retaining compound or an equivalent on mounting surface of support.

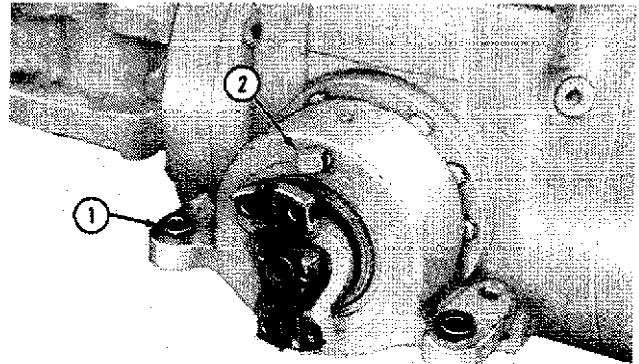

06A;177480 T09;020042 Z21280

6. Lift differential and axle assembly under engine frame. Install cap screws, washers and nuts to fasten front support. Tighten 5/8 in. cap screws to (325 N·m) 240 lb-ft. Tighten 20 mm cap screws to (680 ± 68 N·m) 500 ± 50 lb-ft.

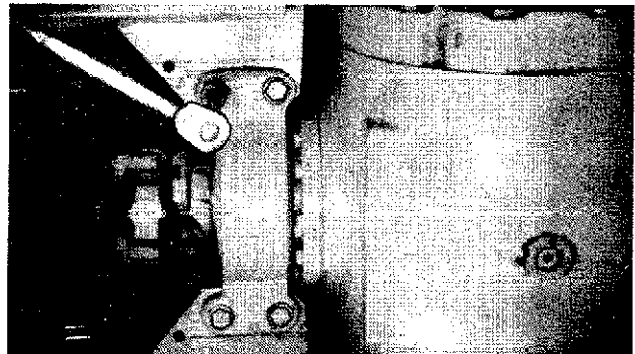

06A;T77481 T09;020043 030682

7. Install cap screws, washers and nuts to fasten rear support. Tighten 5/8 in. cap screws to (325 N·m) 240 lb-ft. Tighten 20 mm cap screws to (680 ± 68 N·m) 500 ± 50 lb-ft.

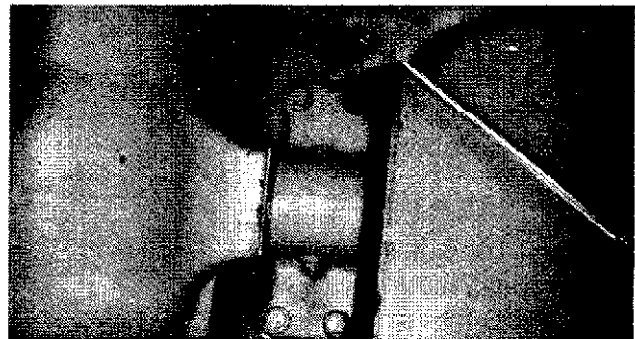

06A;T77472 T09;020044 030682

CONNECT DIFFERENTIAL DRIVE LINE AND OSCILLATING GREASE LINES

1. Connect rear differential drive line and fasten with cap screws. Tighten cap screws to (130 ± 7 N·m) 95 ± 5 lb-ft.

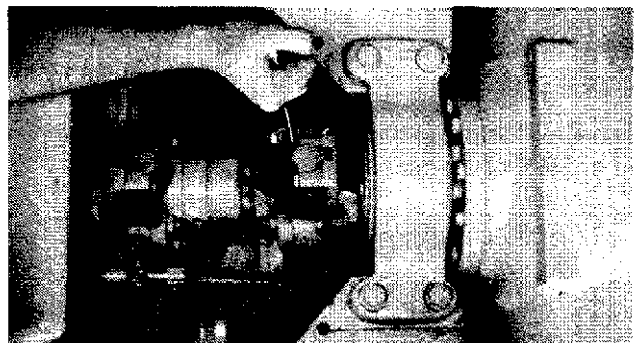

06A;T77468 T09;020045 171280

Removal and Installation

2. Connect the oscillating grease lines (1) on both front and rear supports.

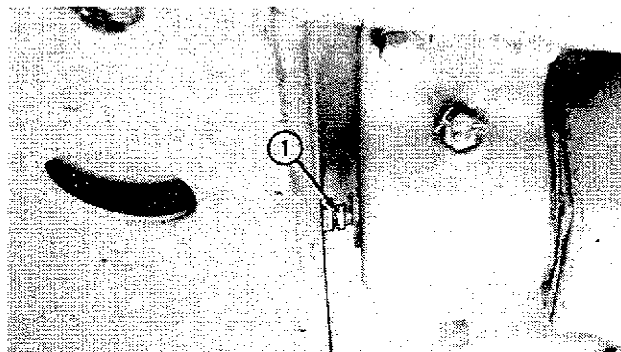

06A:17747G T09:020046 171280

CONNECT BRAKE LINE

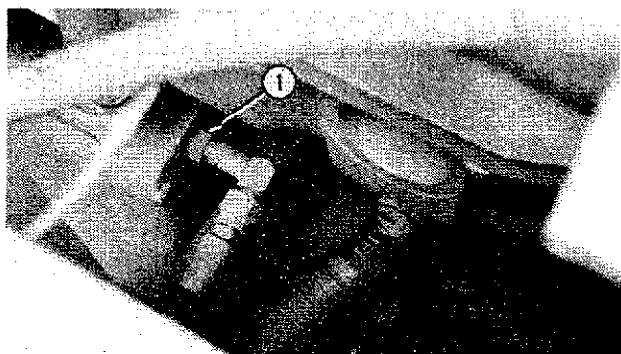

1—Brake Line

06A:17746E T09:020047 171280

REMOVE SHOP STANDS

1. Install wheels (Group 0110). Remove lifting straps.
2. Lift the rear of unit to remove shop stands.

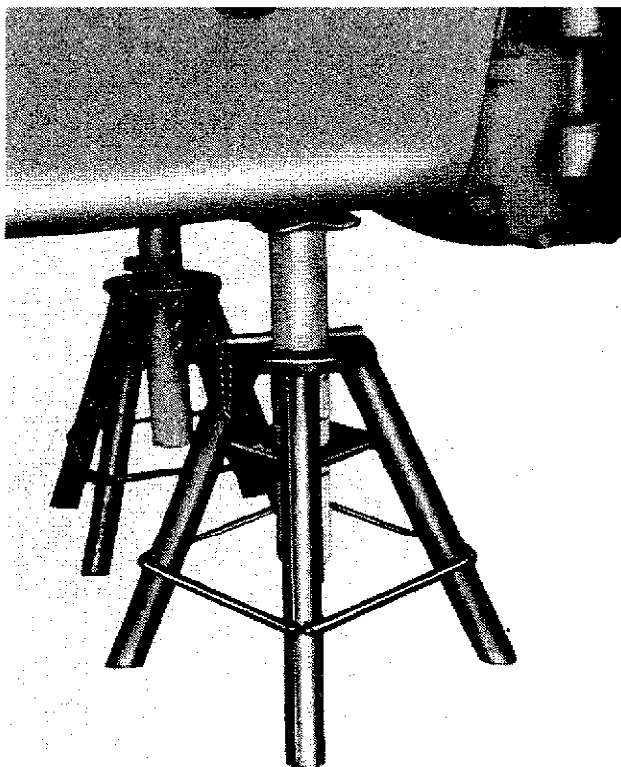

06A:17745E T09:020048 171280



Suggest:

If the above button click is invalid.

Please download this document

first, and then click the above link

to download the complete manual.

Thank you so much for reading

FILL DIFFERENTIAL WITH OIL

1. Install drain plug.
2. Fill the rear differential **SLOWLY** with recommended oil to fill plug level. See Section I, Group IV for the type of oil used. Let the unit stand for approximately one minute and check the differential oil level. Add more oil if necessary.
3. Bleed brake hydraulic system (Group 1060).
4. Install the center bottom guard (if equipped).

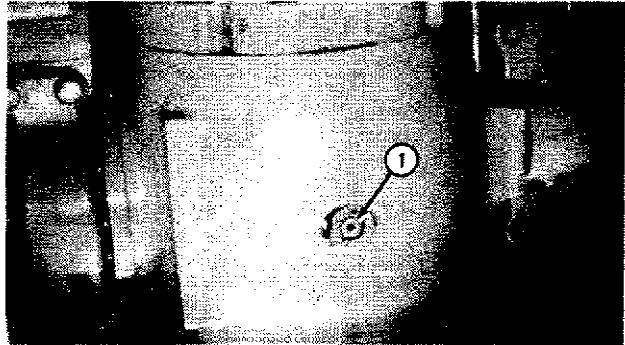

06A;T77467 T09;020049 080982

<https://www.ebooklibonline.com>

Hello dear friend!

Thank you very much for reading.

Enter the link into your browser.

The full manual is available for immediate download.

<https://www.ebooklibonline.com>