

# **F710 and F725 Front Mowers**



## **TECHNICAL MANUAL**

**John Deere  
Lawn & Grounds Care Division  
TM1493 (Feb-95)**

# Introduction

## FOREWORD

This manual is written for an experienced technician. Essential tools required in performing certain service work are identified in this manual and are recommended for use.

Live with safety: Read the safety messages in the introduction of this manual and the cautions presented throughout the text of the manual.

**N** This is the safety-alert symbol. When you see this symbol on the machine or in this manual, be alert to the potential for personal injury.

Technical manuals are divided in two parts: repair and diagnostics. Repair sections tell how to repair the components. Diagnostic sections help you identify the majority of routine failures quickly.

Information is organized in groups for the various components requiring service instruction. At the beginning of each group are summary listings of all applicable essential tools, other materials needed to do the job and service parts kits.

Section 10, Group 15—Repair Specifications, consist of all applicable specifications, near tolerances and specific torque values for various components on each individual machine.

Binders, binder labels, and tab sets can be ordered by John Deere dealers direct from the John Deere Distribution Service Center.

This manual is part of a total product support program.

FOS MANUALS—REFERENCE

TECHNICAL MANUALS—MACHINE SERVICE

COMPONENT MANUALS—COMPONENT SERVICE

Fundamentals of Service (FOS) Manuals cover basic theory of operation, fundamentals of troubleshooting, general maintenance, and basic type of failures and their causes. FOS Manuals are for training new personnel and for reference by experienced technicians.

Technical Manuals are concise guides for specific machines. Technical manuals are on-the-job guides containing only the vital information needed for diagnosis, analysis, testing, and repair.

Component Technical Manuals are concise service guides for specific components. Component technical manuals are written as stand-alone manuals covering multiple machine applications.

# Contents

## SECTION 10—GENERAL INFORMATION

- Group 05—Safety
- Group 10—General Specifications
- Group 15—Repair Specifications
- Group 20—Fuels and Lubricants
- Group 25—Serial Number Locations
- Group 30—Features and Attachments
- Group 35—Service Information Bulletin Listing

## SECTION 20—ENGINE REPAIR—F710

- Group 05—Engine—FC540V
- Group 10—Muffler—F710

## SECTION 25—ENGINE REPAIR—F725

- Group 05—Engine—FD590V
- Group 10—Muffler—F725
- Group 15—Cooling System—F725

## SECTION 30—FUEL AND AIR REPAIR—F710

- Group 05—Fuel System—FC540V
- Group 10—Air System—FC540V

## SECTION 35—FUEL AND AIR REPAIR—F725

- Group 05—Fuel System—FD590V
- Group 10—Air System—FD590V

## SECTION 40—ELECTRICAL REPAIR

- Group 05—Battery and Cables
- Group 10—Electrical System Components
- Group 15—Electric PTO Clutch
- Group 20—Wiring Harness

## SECTION 50—POWER TRAIN REPAIR

- Group 05—Hydrostatic Transmission and Differential Assembly
- Group 10—Hydrostatic Transmission
- Group 15—Differential Assembly

## SECTION 60—STEERING AND BRAKE REPAIR

- Group 05—Steering System Repair
- Group 10—Brake Repair

## SECTION 70—HYDRAULIC REPAIR

- Group 05—Hydraulic Control Valve

- Group 10—Hydraulic Lift Cylinder
- Group 15—Hydrostatic Oil Cooler and Filter
- Group 20—Hydraulic Lines

## SECTION 80—MISCELLANEOUS REPAIR

- Group 05—PTO Assembly
- Group 10—Rear Axle
- Group 15—Wheels and Bearings
- Group 20—Seat
- Group 25—Lift Arm Assembly
- Group 30—Mower Deck Repair

## SECTION 210—TEST & ADJUSTMENT SPECIFICATIONS/OPERATIONAL CHECKOUT PROCEDURE

- Group 05—Test & Adjustment Specifications
- Group 10—Operational Checkout Procedures

## SECTION 220—ENGINE OPERATION, TESTS AND ADJUSTMENTS - FC540V ENGINE

- Group 05—Component Location
- Group 10—Theory of Operation
- Group 15—Diagnosis, Tests & Adjustments

## SECTION 225—ENGINE OPERATION, TESTS, AND ADJUSTMENTS - FD590V ENGINE

- Group 05—Component Location
- Group 10—Theory of Operation
- Group 15—Diagnosis, Tests & Adjustments

## SECTION 230—FUEL/AIR OPERATION TESTS & ADJUSTMENTS - FC540V ENGINE

- Group 05—Component Location
- Group 10—Theory of Operation
- Group 15—Diagnosis, Tests & Adjustments

## SECTION 235—FUEL/AIR OPERATION TESTS & ADJUSTMENTS - FD590V ENGINE

- Group 05—Component Location
- Group 10—Theory of Operation

Continued on next page

*All information, illustrations and specifications in this manual are based on the latest information available at the time of publication. The right is reserved to make changes at any time without notice.*

TM1493-19-16JAN91

COPYRIGHT©1990  
DEERE & COMPANY  
Moline, Illinois  
All rights reserved

A John Deere ILLUSTRATION™ Manual

**<https://www.ebooklibonline.com>**

Hello dear friend!

Thank you very much for reading.

Enter the link into your browser.

The full manual is available for immediate download.

**<https://www.ebooklibonline.com>**

Group 15—Diagnosis, Tests & Adjustments

**SECTION 240—ELECTRICAL OPERATION TESTS  
& ADJUSTMENTS - FC540V  
ENGINE**

- Group 05—Component Location
- Group 10—Theory of Operation
- Group 15—Diagnosis, Tests & Adjustments
- Group 20—Wiring Schematics

**SECTION 245—ELECTRICAL OPERATION TESTS  
& ADJUSTMENTS - FD590V  
engine**

- Group 05—Component Location
- Group 10—Theory of Operation
- Group 15—Diagnosis, Tests & Adjustments
- Group 20—Wiring Schematics

**SECTION 250—POWER TRAIN OPERATION  
TESTS & ADJUSTMENTS**

- Group 05—Component Location
- Group 10—Theory of Operation
- Group 15—Diagnosis, Tests & Adjustments

**SECTION 260—STEERING & BRAKES  
OPERATION TESTS &  
ADJUSTMENTS**

- Group 05—Component Location
- Group 10—Theory of Operation
- Group 15—Diagnosis, Tests & Adjustments

**SECTION 270—HYDRAULIC OPERATION TESTS  
& ADJUSTMENTS**

- Group 05—Component Location
- Group 10—Theory of Operation
- Group 15—Diagnosis, Tests & Adjustments
- Group 20—Hydraulic Schematic

**SECTION 280—MISCELLANEOUS OPERATION  
TESTS & ADJUSTMENTS**

- Group 05—Component Location
- Group 10—Theory of Operation
- Group 15—Diagnosis, Tests & Adjustments

**Index**

# Section 10

# GENERAL INFORMATION

## Contents

	Page	Page
<b>Group 05—Safety</b> .....	10-05-1	
<b>Group 10—General Specifications</b>		
Specifications		
Machine .....	10-10-1	
Mower Deck .....	10-10-2	
<b>Group 15—Repair Specifications</b>		
Repair Specifications .....	10-15-1	
Tune-Up		
Specifications .....	10-15-3	
Adjustments .....	10-15-4	
Service Recommendations		
O-Ring Boss Fittings .....	10-15-5	
Flat Face O-Ring Seal Fittings .....	10-15-6	
Metric Series Torque Chart .....	10-15-7	
Inch Series Torque Chart .....	10-15-8	
<b>Group 20—Fuels and Lubricants</b>		
Fuel .....	10-20-1	
Fuel Storage .....	10-20-1	
Gasoline Engine Oil .....	10-20-2	
Engine Coolant .....	10-20-2	
Hydrostatic Drive Oil .....	10-20-3	
Extreme Pressure Grease .....	10-20-3	
Lubricant Storage .....	10-20-4	
Alternative Lubricants .....	10-20-4	
<b>Group 25—Serial Number Locations</b>		
Serial Numbers .....	10-25-1	
Record		
Product Identification Card .....	10-25-1	
Engine Serial Number .....	10-25-2	
Steering Valve Serial Number .....	10-25-2	
Hydrostatic Transmission Serial Number .....	10-25-3	
Differential Serial Number .....	10-25-3	
PTO Gearbox Serial Number .....	10-25-4	
Mower Deck Serial Number .....	10-25-5	
<b>Group 30—Features and Attachments</b>		
F710/F725 Front Mowers .....	10-30-1	
F710 .....	10-30-2	
F725 .....	10-30-3	
FC540V Engine .....	10-30-4	
FD590V .....	10-30-4	
Power Train .....	10-30-5	
Hydraulic System .....	10-30-6	
Frame .....	10-30-7	
Steering System .....	10-30-7	
Mower Decks .....	10-30-8	
Optional Attachments & Kits .....	10-30-8	
<b>Group 35—Service Information Bulletin Listing</b> .....	10-35-1	

## RECOGNIZE SAFETY INFORMATION

This is the safety-alert symbol. When you see this symbol on your machine or in this manual, be alert to the potential for personal injury.

Follow recommended precautions and safe operating practices.



DX,ALERT -19-04JUN90

10  
05  
1  
-UN-07DEC88  
T81389

## UNDERSTAND SIGNAL WORDS

A signal word—DANGER, WARNING, or CAUTION—is used with the safety-alert symbol. DANGER identifies the most serious hazards.

DANGER or WARNING safety signs are located near specific hazards. General precautions are listed on CAUTION safety signs. CAUTION also calls attention to safety messages in this manual.



DX,SIGNAL -19-04JUN90

-19-30SEP88  
TS187

## FOLLOW SAFETY INSTRUCTIONS

Carefully read all safety messages in this manual and on your machine safety signs. Keep safety signs in good condition. Replace missing or damaged safety signs. Be sure new equipment components and repair parts include the current safety signs. Replacement safety signs are available from your John Deere dealer.

Learn how to operate the machine and how to use controls properly. Do not let anyone operate without instruction.

Keep your machine in proper working condition. Unauthorized modifications to the machine may impair the function and/or safety and affect machine life.

If you do not understand any part of this manual and need assistance, contact your John Deere dealer.

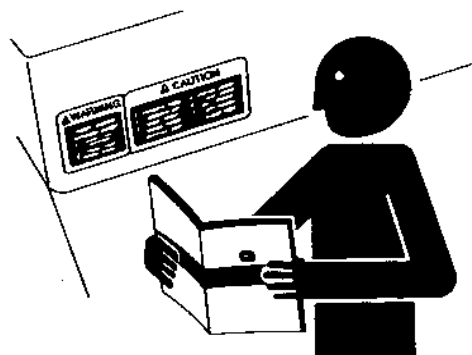

DX,READ -19-04JUN90

-UN-23AUG88  
TS201

## HANDLE FLUIDS SAFELY—AVOID FIRES

When you work around fuel, do not smoke or work near heaters or other fire hazards.

Store flammable fluids away from fire hazards. Do not incinerate or puncture pressurized containers.

Make sure machine is clean of trash, grease, and debris.

Do not store oily rags; they can ignite and burn spontaneously.



DX,FLAME -19-04JUN90

TS227 -UN-23AUG88

## PREVENT BATTERY EXPLOSIONS

Keep sparks, lighted matches, and open flame away from the top of battery. Battery gas can explode.

Never check battery charge by placing a metal object across the posts. Use a volt-meter or hydrometer.

Do not charge a frozen battery; it may explode. Warm battery to 16°C (60°F).



DX,SPARKS -19-04JUN90

TS204 -UN-23AUG88

## PREPARE FOR EMERGENCIES

Be prepared if a fire starts.

Keep a first aid kit and fire extinguisher handy.

Keep emergency numbers for doctors, ambulance service, hospital, and fire department near your telephone.

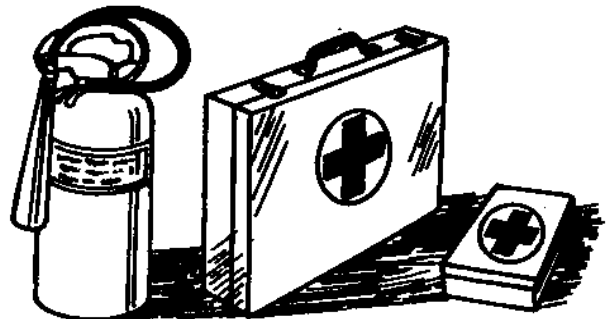

DX,FIRE2 -19-04JUN90

TS291 -UN-23AUG88

## PREVENT ACID BURNS

Sulfuric acid in battery electrolyte is poisonous. It is strong enough to burn skin, eat holes in clothing, and cause blindness if splashed into eyes.

Avoid the hazard by:

1. Filling batteries in a well-ventilated area.
2. Wearing eye protection and rubber gloves.
3. Avoiding breathing fumes when electrolyte is added.
4. Avoiding spilling or dripping electrolyte.
5. Use proper jump start procedure.

If you spill acid on yourself:

1. Flush your skin with water.
2. Apply baking soda or lime to help neutralize the acid.
3. Flush your eyes with water for 10—15 minutes. Get medical attention immediately.

If acid is swallowed:

1. Drink large amounts of water or milk.
2. Then drink milk of magnesia, beaten eggs, or vegetable oil.
3. Get medical attention immediately.

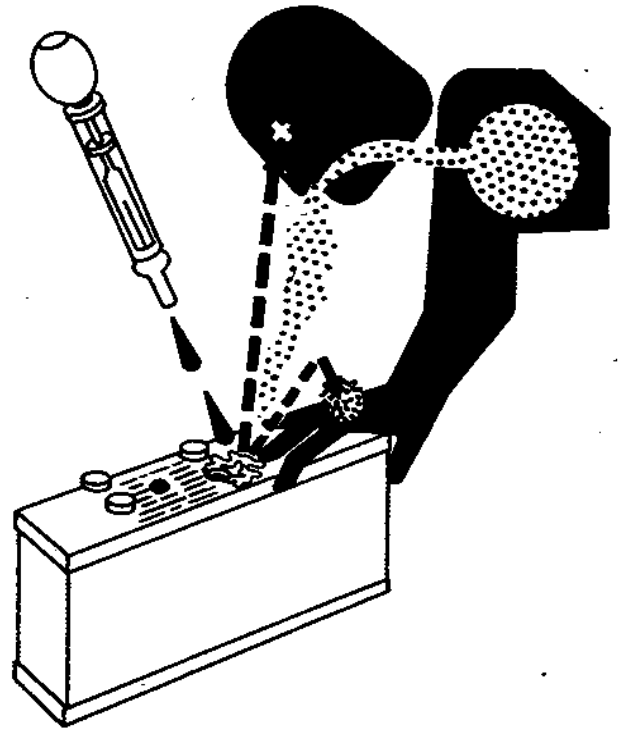

DX,POISON -19-04JUN90

10  
305

-UN-23AUG88  
TS203

## SERVICE COOLING SYSTEM SAFELY

Explosive release of fluids from pressurized cooling system can cause serious burns.

Shut off engine. Only remove filler cap when cool enough to touch with bare hands. Slowly loosen cap to first stop to relieve pressure before removing completely.



DX,RCAP -19-04JUN90

-UN-23AUG88  
TS281

## AVOID HIGH-PRESSURE FLUIDS

Escaping fluid under pressure can penetrate the skin causing serious injury.

Avoid the hazard by relieving pressure before disconnecting hydraulic or other lines. Tighten all connections before applying pressure.

Search for leaks with a piece of cardboard. Protect hands and body from high pressure fluids.

If an accident occurs, see a doctor immediately. Any fluid injected into the skin must be surgically removed within a few hours or gangrene may result. Doctors unfamiliar with this type of injury may call the Deere & Company Medical Department in Moline, Illinois, or other knowledgeable medical source.

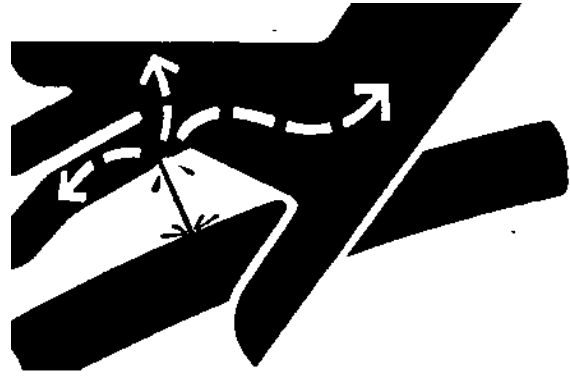

DX,FLUID,NA -19-11JUN90

-UN-23AUG88

X9811

## PARK MACHINE SAFELY

Before working on the machine:

- Lower all equipment to the ground.
- Stop the engine and remove the key.
- Disconnect the battery ground strap.
- Hang a "DO NOT OPERATE" tag in operator station.

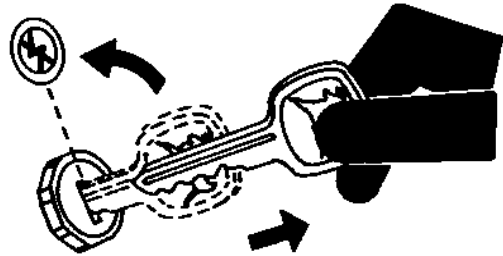

DX,PARK -19-04JUN90

-UN-24MAY69

TS230

### SUPPORT MACHINE PROPERLY

Always lower the attachment or implement to the ground before you work on the machine. If you must work on a lifted machine or attachment, securely support the machine or attachment.

Do not support the machine on cinder blocks, hollow tiles, or props that may crumble under continuous load. Do not work under a machine that is supported solely by a jack. Follow recommended procedures in this manual.

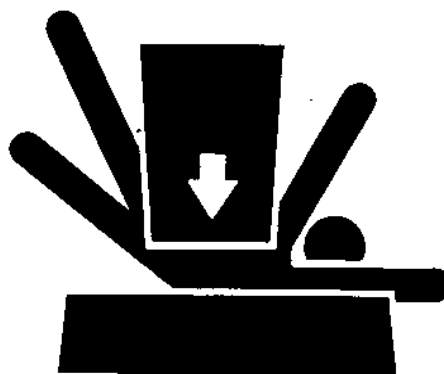

DX,LOWER -19-04JUN90

### WEAR PROTECTIVE CLOTHING

Wear close fitting clothing and safety equipment appropriate to the job.

Prolonged exposure to loud noise can cause impairment or loss of hearing.

Wear a suitable hearing protective device such as earmuffs or earplugs to protect against objectionable or uncomfortable loud noises.

Operating equipment safely requires the full attention of the operator. Do not wear radio or music headphones while operating machine.

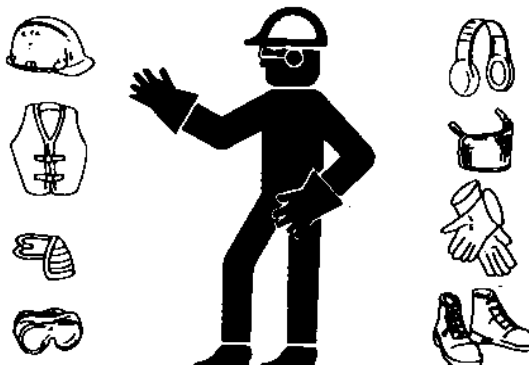

DX,WEAR -19-10SEP90

### WORK IN CLEAN AREA

Before starting a job:

- Clean work area and machine.
- Make sure you have all necessary tools to do your job.
- Have the right parts on hand.
- Read all instructions thoroughly; do not attempt shortcuts.

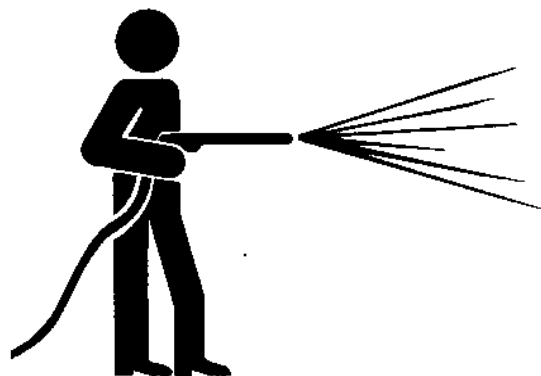

DX,CLEAN -19-04JUN90

51010  
-UN-23AUG88  
TS229

-UN-23AUG88  
TS206

-UN-18OCT88  
T6642EJ

### SERVICE MACHINES SAFELY

Tie long hair behind your head. Do not wear a necktie, scarf, loose clothing, or necklace when you work near machine tools or moving parts. If these items were to get caught, severe injury could result.

Remove rings and other jewelry to prevent electrical shorts and entanglement in moving parts.

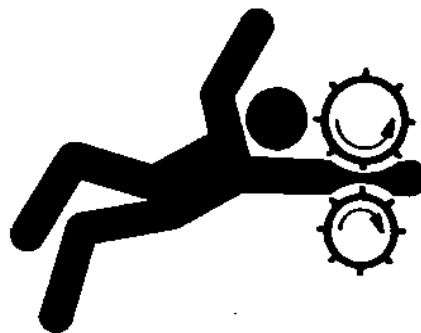

DX, LOOSE -19-04JUN90

TS228 -UN-23AUG88

### WORK IN VENTILATED AREA

Engine exhaust fumes can cause sickness or death. If it is necessary to run an engine in an enclosed area, remove the exhaust fumes from the area with an exhaust pipe extension.

If you do not have an exhaust pipe extension, open the doors and get outside air into the area.

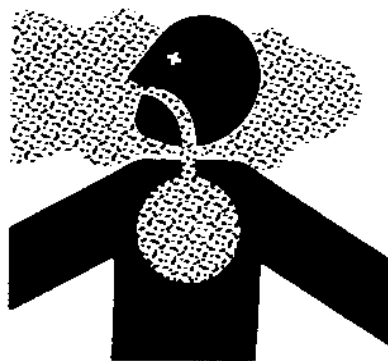

DX, AIR -19-04JUN90

TS220 -UN-23AUG88

### ILLUMINATE WORK AREA SAFELY

Illuminate your work area adequately but safely. Use a portable safety light for working inside or under the machine. Make sure the bulb is enclosed by a wire cage. The hot filament of an accidentally broken bulb can ignite spilled fuel or oil.



DX, LIGHT -19-04JUN90

TS223 -UN-23AUG88

### REPLACE SAFETY SIGNS

Replace missing or damaged safety signs. See the machine operator's manual for correct safety sign placement.

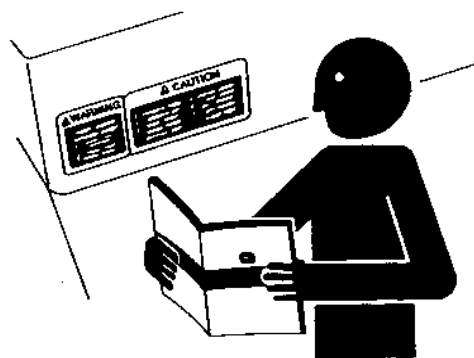

DX, SIGNS1 -19-04JUN90

TS201 -UN-23AUG88

69510

## USE PROPER LIFTING EQUIPMENT

Lifting heavy components incorrectly can cause severe injury or machine damage.

Follow recommended procedure for removal and installation of components in the manual.

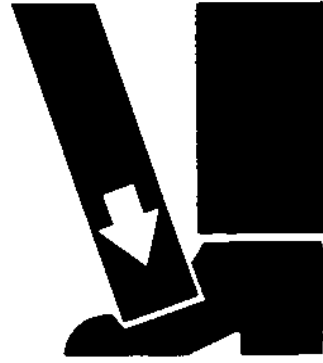

DX,LIFT -19-04JUN90

10  
05  
7  
-UN-23AUG88

TS226

## SERVICE TIRES SAFELY

Explosive separation of a tire and rim parts can cause serious injury or death.

Do not attempt to mount a tire unless you have the proper equipment and experience to perform the job.

Always maintain the correct tire pressure. Do not inflate the tires above the recommended pressure. Never weld or heat a wheel and tire assembly. The heat can cause an increase in air pressure resulting in a tire explosion. Welding can structurally weaken or deform the wheel.

When inflating tires, use a clip-on chuck and extension hose long enough to allow you to stand to one side and NOT in front of or over the tire assembly. Use a safety cage if available.

Check wheels for low pressure, cuts, bubbles, damaged rims or missing lug bolts and nuts.



DX,TIRECP -19-24AUG90

-UN-12APR90

TS952

## AVOID HARMFUL ASBESTOS DUST

Avoid breathing dust that may be generated when handling components containing asbestos fibers. Inhaled asbestos fibers may cause lung cancer.

Components in products that may contain asbestos fibers are brake pads, brake band and lining assemblies, clutch plates, and some gaskets. The asbestos used in these components is usually found in a resin or sealed in some way. Normal handling is not hazardous as long as airborne dust containing asbestos is not generated.

Avoid creating dust. Never use compressed air for cleaning. Avoid brushing or grinding of asbestos containing materials. When servicing, wear an approved respirator. A special vacuum cleaner is recommended to clean asbestos. If not available, wet the asbestos containing materials with a mist of oil or water.

Keep bystanders away from the area.

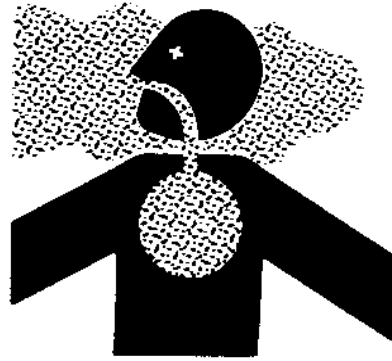

TS220 -UN-23AUG88

DX,DUST -19-27AUG90

## AVOID HEATING NEAR PRESSURIZED FLUID LINES

Flammable spray can be generated by heating near pressurized fluid lines, resulting in severe burns to yourself and bystanders. Do not heat by welding, soldering, or using a torch near pressurized fluid lines or other flammable materials. Pressurized lines can be accidentally cut when heat goes beyond the immediate flame area.



TS953 -UN-15MAY90

DX,TORCH -19-05OCT90

## REMOVE PAINT BEFORE WELDING OR HEATING

Avoid potentially toxic fumes and dust.

Hazardous fumes can be generated when paint is heated by welding, soldering, or using a torch.

Do all work outside or in a well ventilated area. Dispose of paint and solvent properly.

Remove paint before welding or heating:

- If you sand or grind paint, avoid breathing the dust. Wear an approved respirator.
- If you use solvent or paint stripper, remove stripper with soap and water before welding. Remove solvent or paint stripper containers and other flammable material from area. Allow fumes to disperse at least 15 minutes before welding or heating.

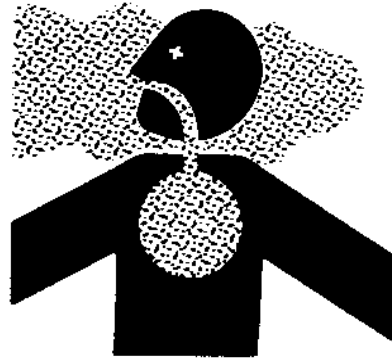

DX,PAINT -19-04JUN90

10  
9051  
-UN-23AUG88  
TS220

## USE PROPER TOOLS

Use tools appropriate to the work. Makeshift tools and procedures can create safety hazards.

Use power tools only to loosen threaded parts and fasteners.

For loosening and tightening hardware, use the correct size tools. DO NOT use U.S. measurement tools on metric fasteners. Avoid bodily injury caused by slipping wrenches.

Use only service parts meeting John Deere specifications.



DX,REPAIR -19-04JUN90

-UN-08NOV89  
TS779

## DISPOSE OF FLUIDS PROPERLY

Improperly disposing of fluids can harm the environment and ecology. Before draining any fluids, find out the proper way to dispose of waste from your local environmental agency.

Use proper containers when draining fluids. Do not use food or beverage containers that may mislead someone into drinking from them.

DO NOT pour oil into the ground, down a drain, or into a stream, pond, or lake. Observe relevant environmental protection regulations when disposing of oil, fuel, coolant, brake fluid, filters, batteries, and other harmful waste.

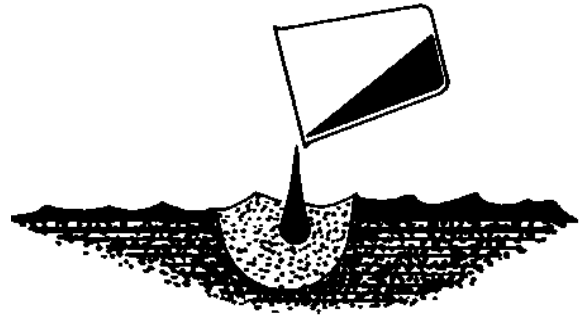

DX,DRAIN -19-05JUN90

TS222 -UN-23AUG88

## LIVE WITH SAFETY

Before returning machine to customer, make sure machine is functioning properly, especially the safety systems. Install all guards and shields.



DX,LIVE -19-04JUN90

TS231 -19-07OCT88

10  
05  
10

**MACHINE SPECIFICATIONS**

	F710	F725
<b>ENGINE</b>		
Make	John Deere "K" Series	John Deere "K" Series
Type	OHV	OHV
Model	FC540V	FD590V
Horsepower	12.6 kW (17 hp)	15 kW (20 hp)
Number of Cylinders	1	2 (V-twin)
Displacement	535 cm <sup>3</sup> (32.64 cu. in.)	585 cm <sup>3</sup> (35.7 cu in.)
Bore and Stroke	89 x 86 mm (3.5 x 3.38 in.)	74 x 68 mm (2.9 x 2.68 in.)
Fast Idle	3350 rpm	3350 rpm
Slow Idle	1550 rpm	1550 rpm
Starting System	Electric	Electric
Lubrication	Pressurized	Pressurized
Cooling System	Forced Air	Liquid
Air Cleaner	Dry 2 Stage Replaceable	Dry 2 Stage Replaceable
Engine Shutoff	Key Switch	Key Switch
<b>FUEL SYSTEM</b>		
Type	Carburetor	Carburetor
Fuel Delivery	Fuel Pump	Fuel Pump
<b>ELECTRICAL SYSTEM</b>		
Type	12 Volt	12 Volt
Battery Size	335 Cold Cranking Amps at -18°C (0°F)	491 Cold Cranking amps at -18°C (0°F)
Alternator	15 Amp	17 Amp
<b>POWER TRAIN</b>		
Type	Hydrostatic Transmission	Hydrostatic Transmission
Number of Speeds	Infinite	Infinite
Travel Speeds at Full Engine RPM		
Forward	0—11.2 km/h (0—7 mph)	0—11.2 km/h (0—7 mph)
Reverse	0—4.8 km/h (0—3 mph)	0—4.8 km/h (0—3 mph)
PTO Clutch	Engine-mounted, electric	Engine-mounted, electric
<b>STEERING/BRAKES</b>		
Brakes	Independent, shoe and drum	Independent, shoe and drum
Steering	Power, hydrostatic	Power, hydrostatic

MX,1010GC,A1 -19-15JAN91

*General Specifications/Specifications*

10  
10  
2

**F710**

**F725**

**HYDRAULIC SYSTEM**

Control Valve	Two position with variable orifice	Two position with variable orifice
Lift Cylinder	Front mounted	Front mounted
Oil Cooler	Radiator type	Radiator type

**CAPACITIES**

Fuel Tank	26.5 L (7.0 U.S. gal)	26.5 L (7.0 U.S. gal)
Engine Crankcase	1.9 L (4.0 U.S. pt)	2.1 L (4.44 U.S. pt)
Hydrostatic Transmission	1.6 L (1.7 U.S. qt)	1.9 L (2.0 U.S. qt)
Engine Coolant	N/A	3.1 L (3.3 U.S. qt)

**TIRES**

**Standard Equipment**

Front (drive)	20 x 10.00—8	20 x 10.00—8
Rear (steering)	15 x 6.00—6	15 x 6.00—6

**OVERALL DIMENSIONS:**

Wheelbase	1.0 m (39.4 in.)	1.0 m (39.4 in.)
Length	2.5 m (98.75 in.)	2.5 m (98.75 in.)
Width	1.31 m (51.8 in.)	1.47 m (57.8 in.)
Height	1.21 m (47.6 in.)	1.21 m (47.6 in.)
Approximate Shipping Weight	489 kg (1078 lb)	494 kg (1089 lb)

*(Specifications and design subject to change without notice.)*

MX,1010GC,A2 -19-15JAN91

**MOWER DECK SPECIFICATIONS**

**48 Inch Deck**

**54 Inch Deck**

Deck Material	11 gauge (3 mm) steel one-piece stamped	11 gauge (3 mm) steel one-piece stamped
Blades	3	3
Blade Length	42 cm (16.6 in.)	47 cm (18.6 in.)
Blade Drive	Drive shaft, gearbox	Drive shaft, gearbox
Cutting Height	25.4—102 mm (1—4 in.)	25.4—102 mm (1—4 in.)
Shipping Weight	106 kg (233 lbs)	110 kg (243 lbs)

*(Specifications and design subject to change without notice.)*

MX,1010GC,A3 -19-15JAN91

## REPAIR SPECIFICATIONS

Item	Measurement	Specification
<b>SECTION 20—ENGINE REPAIR—F710</b>		
For all repair specifications—Use CTM5		
Engine-to-Frame Cap Screw	Torque	41 N·m (30 lb-ft)
<b>SECTION 25—ENGINE REPAIR—F725</b>		
For all repair specifications—Use CTM39		
Engine-to-Frame Cap Screw	Torque	41 N·m (30 lb-ft)
<b>SECTION 30—FUEL AND AIR REPAIR—F710</b>		
For all carburetor repair specifications—Use CTM5		
Flywheel Screen-to-Blower Housing	Gap Adjustment	1.5 mm (0.059 in.) (MIN)
<b>SECTION 35—FUEL AND AIR REPAIR—F725</b>		
For all carburetor repair specifications—Use CTM39		
Air Duct-to-Carburetor Cap Screw and Nut	Torque	8 N·m (71 lb-in.)
Fuel Pump Push Rod	Maximum Bend	0.05 mm (0.002 in.)
<b>SECTION 40—ELECTRICAL SYSTEM</b>		
F710: For all starter and engine ignition and charging system repair—Use CTM5		
F725: For all starter and engine ignition and charging system repair—Use CTM39		
PTO Clutch-to-Engine Cap Screw	Torque	67 N·m (50 lb-ft)
<b>SECTION 50—POWER TRAIN REPAIR</b>		
Hydrostatic Transmission/Differential Assembly Nut	Torque	35 N·m (25 lb-ft)
Hydrostatic Transmission Hydrostatic Transmission-to-Differential Assembly Cap Screw	Torque	16 N·m (143 lb-in.)
Driven Sheave Center Hub-to-Input Shaft	Depth	12 mm (0.500 in.)
Pump Inner Rotor Tip-to-Outer Rotor Lobe	Clearance (MAX)	0.13 mm (0.005 in.)
Pump Inner Rotor	Side Clearance (MAX)	0.05 mm (0.002 in.)
Charge Pump Cover-to-Transmission Housing Cap Screw	Torque	11 N·m (96 lb-in.)

10  
15  
2

Item	Measurement	Specification
<b>SECTION 50—POWER TRAIN REPAIR—CONTINUED</b>		
Differential Assembly		
Idler Shaft Oil Groove Washers	Thickness (MIN)	1.50 mm (0.059 in.)
Differential Thrust Washers	Thickness (MIN)	0.50 mm (0.020 in.)
Differential Pinion Washers	Thickness (MIN)	0.50 mm (0.020 in.)
Bevel Pinion Gears-to-Shaft	Clearance (MAX)	0.40 mm (0.016 in.)
Axle Shaft Washers	Thickness (MIN)	1.50 mm (0.059 in.)
Axle Shaft Bearing on Axle Shaft	Depth	1.50 mm (0.059 in.)
Differential Housing Half Cap Screw	Torque	27 N·m (20 lb-ft)
Differential Assembly Case Half Cap Screws		
New Case	Torque	30 N·m (265 lb-in.)
Old Case	Torque	26 N·m (230 lb-in.)
Fittings-to-Differential Case	Torque	2 N·m (17 lb-in.)
Filter Adapter-to-Differential Case	Torque	39 N·m (29 lb-ft)
Input Pinion-to-Reduction Shaft Backlash	Adjustment	0.06—0.24 mm (0.002—0.009 in.)
<b>SECTION 60 STEERING AND BRAKE REPAIR</b>		
Steering System		
Steering Valve End Cap		
Cap Screw	Torque	
	Initial	11 N·m (95 lb-in.)
	Final	21 N·m (182 lb-in.)
Steering Cylinder Nut	Torque	66 N·m (49 lb-ft)
Brakes		
Cover Cap Screws		
New Case	Torque	30 N·m (22 lb-ft)
Used Case	Torque	26 N·m (19 lb-ft)
<b>SECTION 70 HYDRAULIC REPAIR</b>		
Oil Cooler Lines-to-Hydrostatic Oil		
Cooler Fitting	Torque	23 N·m (209 lb-in.)

MX,1015GC,A2 -19-15JAN91

**SECTION 80 MISCELLANEOUS REPAIR**

PTO Gearbox-to-Frame Cap Screw	Torque	130 N·m (95 lb-ft)
Rear Axle		
Support Link/Steering Cylinder Assembly Cap Screw	Torque	130 N·m (95 lb-ft)
Link-to-Axle Cap Screw	Torque	61 N·m (45 lb-ft)
Steering Cylinder-to-Support Nut	Torque	66 N·m (49 lb-ft)
Tie Rod Arm Nut	Torque	47 N·m (35 lb-ft)
Drive Wheel Cap Screw	Torque	80 N·m (60 lb-ft)
Mower Deck		
Sheave-to-Gearbox Cap Screw	Torque	100 N·m (75 lb-ft)
Gearbox-to-Mower Deck Cap Screw	Torque	70 N·m (50 lb-ft)
Mower Gearbox End Plug	Depth	1.60 mm (0.063 in.)
Mower Gearbox Cover Cap Screw	Torque	23 N·m (200 lb-in.)
Mower Gearbox Output Shaft	Rolling Drag Torque	0.4—1.0 N·m (5—15 oz-in.)
Mower Blade Cap Screw	Torque	75 N·m (55 lb-ft)
Mower Blade Cutting Edge	Thickness	0.40 mm (0.016 in.)
Spindle Nut	Torque	217 N·m (160 lb-ft)

MX,1015GC,A2A -19-15JAN91

**TUNE-UP SPECIFICATIONS**

Spark plug gap . . . . .	0.64 mm (0.025 in.)
Spark plug torque . . . . .	20 N·m (177 lb-in.)
Slow idle setting . . . . .	1400 ± 100 rpm
Fast idle setting . . . . .	3450 ± 100 rpm

MX,1015GC,A3 -19-15JAN91

## TUNE-UP ADJUSTMENTS

Perform tune-up adjustments in the following order to improve the efficiency and operation of the machine.

Tune-up Adjustment	Section	Group
1. Clean engine cooling fins.		
2. Clean or replace air cleaner elements:		
F710	30	10
F725	35	10
3. Check or replace fuel filter:		
F710	30	05
F725	35	05
4. Check battery electrolyte level.	240	15
5. Clean, regap or replace spark plug.	240	15
6. Check engine compression:		
F710	220	15
F725	225	15
7. Adjust throttle cable	230	20
8. Check and adjust choke	230	20
9. Adjust governor	230	20
10. Adjust slow idle stop and idle mixture screw	230	20
11. Adjust slow idle limiter screw	230	20
12. Adjust fast idle limiter screw	230	20
13. Check and adjust brakes.	260	20
14. Check charging system output.	240	20
15. Check tire pressure.		

MX,1015GC,A4 -19-15JAN91

## SERVICE RECOMMENDATIONS FOR O-RING BOSS FITTINGS

### STRAIGHT FITTING

1. Inspect O-ring boss seat for dirt or defects.
2. Lubricate O-ring with petroleum jelly. Place electrical tape over threads to protect O-ring. Slide O-ring over tape and into O-ring groove of fitting. Remove tape.
3. Tighten fitting to torque value shown on chart.

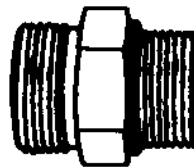

### ANGLE FITTING

1. Back-off lock nut (A) and back-up washer (B) completely to head-end (C) of fitting.
2. Turn fitting into threaded boss until back-up washer (B) contacts face of boss.
3. Turn fitting head-end (C) counterclockwise to proper index (maximum of one turn).
4. Hold fitting head-end (C) with a wrench and tighten locknut (A) and back-up washer (B) to proper torque value.

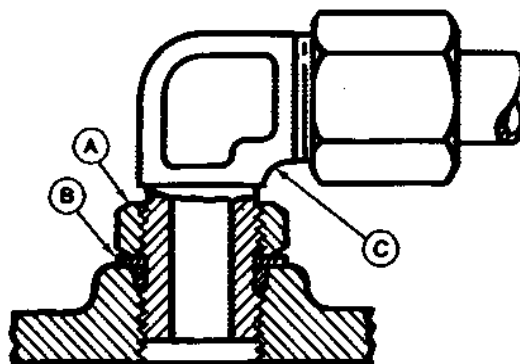

*NOTE: Do not allow hoses to twist when tightening fittings.*

### TORQUE VALUE

Thread Size	N-m	lb-ft
3/8-24 UNF	8	6
7/16-20 UNF	12	9
1/2-20 UNF	16	12
9/16-18 UNF	24	18
3/4-16 UNF	46	34
7/8-14 UNF	62	46
1-1/16-12 UN	102	75
1-3/16-12 UN	122	90
1-5/16-12 UN	142	105
1-5/8-12 UN	190	140
1-7/8-12 UN	217	160

*NOTE: Torque tolerance is  $\pm 10\%$ .*

04T,90,K66 -19-20DEC90

## SERVICE RECOMMENDATIONS FOR FLAT FACE O-RING SEAL FITTINGS

1. Inspect the fitting sealing surfaces. They must be free of dirt or defects.
2. Inspect the O-ring. It must be free of damage or defects.
3. Lubricate O-rings and install into groove using petroleum jelly to hold in place.
4. Push O-ring into the groove with plenty of petroleum jelly so O-ring is not displaced during assembly.
5. Index angle fittings and tighten by hand pressing joint together to insure O-ring remains in place.
6. Tighten fitting or nut to torque valve shown on the chart per dash size stamped on the fitting. Do not allow hoses to twist when tightening fittings.

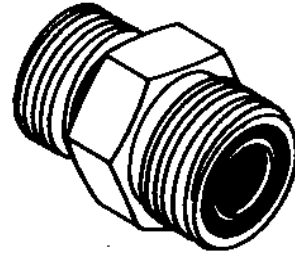









FLAT FACE O-RING SEAL FITTING TORQUE

Nominal Tube mm	O.D. (in.)	Dash Size	Thread Size In.	Swivel Nut Torque		Bulkhead Nut Torque	
				N-m	(lb-ft)	N-m	(lb-ft)
6.35	0.250	-4	9/16-18	16	12	5.0	3.5
9.52	0.375	-6	11/16-16	24	18	9.0	6.5
12.70	0.500	-8	13/16-16	50	37	17.0	12.5
15.88	0.625	-10	1-14	69	51	17.0	12.5
19.05	0.750	-12	1 3/16-12	102	75	17.0	12.5
22.22	0.875	-14	1 3/16-12	102	75	17.0	12.5
25.40	1.000	-16	1 7/16-12	142	105	17.0	12.5
31.75	1.250	-20	1 11/16-12	190	140	17.0	12.5
38.10	1.500	-24	2-12	217	160	17.0	12.5

NOTE: Torque tolerance is +15 -20%.

# INCH CAP SCREW TORQUE VALUES

SAE Grade	Head Markings	SAE Grade	Nut Markings	SAE Grade	Head Markings	SAE Grade	SAE Grade	Nut Markings	SAE Grade	
SAE GRADE 1 SAE GRADE 2	 No Mark	2	 No Mark	SAE GRADE 5 SAE GRADE 5.1 SAE GRADE 5.2	  	5		Nut Markings 	8 SAE GRADE 8 SAE GRADE 8.2	  

DIA.	WRENCH SIZE	SAE GRADE 1		*SAE GRADE 2		SAE GRADE 5		SAE GRADE 8	
		OIL	DRY	OIL	DRY	OIL	DRY	OIL	DRY
		N·m(lb-in)	N·m(lb-in)	N·m(lb-in)	N·m(lb-in)	N·m(lb-in)	N·m(lb-in)	N·m(lb-in)	N·m(lb-in)
#6 #8		0.5(4.5) 0.9(8)	0.7(6) 1.2(11)			1.4(12) 2.4(21)	1.7(15) 3.2(28)		
#10 #12		1.4(12) 2(19)	1.8(16) 2.8(25)			3.4(30) 5.4(48)	4.6(41) 7.3(65)		
		N·m(lb-ft)	N·m(lb-ft)	N·m(lb-ft)	N·m(lb-ft)	N·m(lb-ft)	N·m(lb-ft)	N·m(lb-ft)	N·m(lb-ft)
1/4 5/16	7/16 1/2	3.5(2.5) 7(5)	4(3) 9(6.5)	5(4) 10(7.5)	7(5) 14(10)	8(6) 16(12)	11(8) 23(17)	12(8.5) 24(18)	16(12) 33(24)
3/8 7/16	9/16 5/8	12(8.5) 19(14)	16(12) 26(19)	19(14) 30(22)	24(18) 41(30)	30(22) 47(35)	41(30) 68(50)	41(30) 68(50)	54(40) 95(70)
1/2 9/16	3/4 13/16	24(21) 41(30)	41(30) 54(40)	47(35) 68(50)	61(45) 88(65)	75(55) 108(80)	102(75) 142(105)	102(75) 149(110)	142(105) 203(150)
5/8 3/4	15/16 1-1/8	54(40) 102(75)	75(55) 136(100)	88(65) 163(120)	122(90) 217(160)	149(110) 258(190)	197(145) 353(260)	203(150) 366(270)	278(205) 495(365)
7/8 1	1-5/16 1-1/2	163(120) 244(180)	244(165) 332(245)	163(120) 244(180)	224(165) 332(245)	414(305) 624(460)	563(415) 848(625)	590(435) 881(650)	800(590) 1193(880)
1-1/8 1-1/4	1-11/16 1-7/8	346(255) 488(360)	468(345) 664(490)	346(255) 488(360)	468(345) 665(490)	780(575) 1098(810)	1058(780) 1492(1100)	1248(920) 1763(1300)	1685(1250) 2393(1785)
1-3/8 1-1/2	2-1/16 2-1/4	637(470) 848(625)	868(640) 1153(850)	637(470) 848(625)	868(640) 1153(850)	1438(1061) 1912(1410)	1953(1440) 2590(1910)	2312(1705) 3065(2260)	3140(2315) 4163(3070)

DO NOT use these values if a different torque value or tightening procedure is listed for a specific application. Torque values listed are for general use only. Check tightness of cap screws periodically.

Shear bolts are designed to fail under predetermined loads. Always replace shear bolts with identical grade.

Fasteners should be replaced with the same or higher grade. If higher grade fasteners are used, these should only be tightened to the strength of the original.

\*For SAE Grade 2 fasteners 152 mm (6 in.) or less in length, use torque values for SAE Grade 2. For fasteners longer than 152 mm (6 in.), use SAE Grade 1 torque values.

Make sure fastener threads are clean and you properly start thread engagement. This will prevent them from failing when tightening.

Tighten plastic insert or crimped steel-type lock nuts to approximately 50 percent of amount shown in chart. Tighten toothed or serrated-type lock nuts to full torque value.

## FUEL

**N** **CAUTION:** Handle fuel carefully. If engine is hot or running, do not fill the fuel tank. Stop engine and allow to cool several minutes before filling fuel tank. Do not smoke while you fill the fuel tank or service the fuel system. Fill fuel tank only to bottom of filler neck.

**IMPORTANT:** To avoid engine damage, **DO NOT** mix oil with gasoline.

Unleaded fuel is recommended because it burns cleaner and leaves less unburned deposits in engine combustion chamber. Regulator leaded gasoline with an anti-knock index of 87 or higher may be used.

Use of gasohol is acceptable as long as the ethyl alcohol blend does not exceed 11 percent. Unleaded gasohol is preferred over leaded gasohol.

Fuel Tank Capacity . . . . . 26.5 L (7.0 U.S. gal)

Fill fuel tank at end of each day's operation. Fill only to bottom of filler neck.

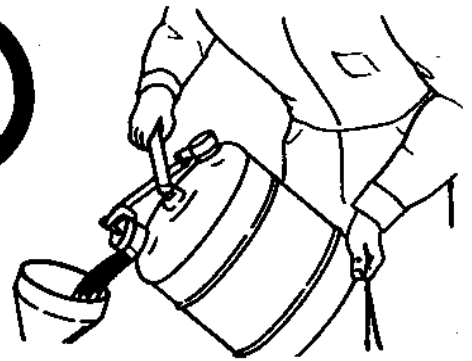

10  
20  
-UN-23AUG88  
TS185

MX,1020GC,A1 -19-15JAN91

## STORING FUEL

If there is a very slow turnover of fuel in the fuel tank or supply tank, it may be necessary to add a fuel conditioner to prevent water condensation. Contact your John Deere dealer for proper service or maintenance recommendations.

DX,FUEL -19-04JUN90

## GASOLINE ENGINE OIL

Use oil viscosity based on the expected air temperature range during the period between oil changes.

John Deere PLUS-4® engine oil is recommended.

Other oils may be used if they meet API Service Classification SG or SF.

Oils meeting Military Specification MIL-L-46167A may be used as arctic oils.

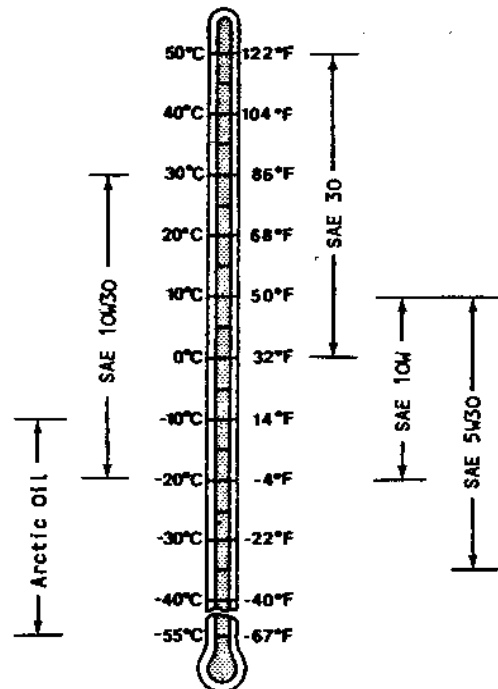

DX,GAS

-19-23AUG90

TS239 -19-09NOV88

## ENGINE COOLANT

John Deere Low Silicate Antifreeze is recommended.

Also recommended is low silicate antifreeze formulated to GM6038M or equivalent.

Other antifreezes that may be used:

- Ethylene-glycol type.
- Those containing not more than 0.1 percent anhydrous metasilicate.
- Those meeting General Motors Performance Specification GM1899M

**IMPORTANT: Some types of ethylene-glycol antifreeze are intended for automotive use. These products are often labeled for use in aluminum engines and usually contain more than 0.1 percent of anhydrous metasilicate.**

Check container label or consult with antifreeze supplier before using.

Mix 50-67 percent low silicate antifreeze with 33-50 percent distilled or deionized water.

Low silicate antifreeze provides:

- Adequate heat transfer.
- Corrosion-resistant environment within the cooling system.
- Compatibility with cooling system hose and seal material.
- Protection during cold and hot weather operations.

Certain geographical areas may require special antifreeze or coolant practices. If you have any questions, consult your authorized servicing dealer to obtain the latest information and recommendations.

DX,COOL

-19-04JUN90

## HYDROSTATIC DRIVE OIL

Use oil viscosity based on the expected air temperature range during the period between oil changes.

John Deere HY-GARD® Transmission/Hydraulic Oil is recommended.

Other oils may be used if they are QUATROL® oils or if they meet John Deere Standard JDM J20A or J20B.

Automatic transmission fluids of Type M2C33F or M2C33G may also be used.

Oils meeting Military Specification MIL-L-46167A may be used as arctic oils.

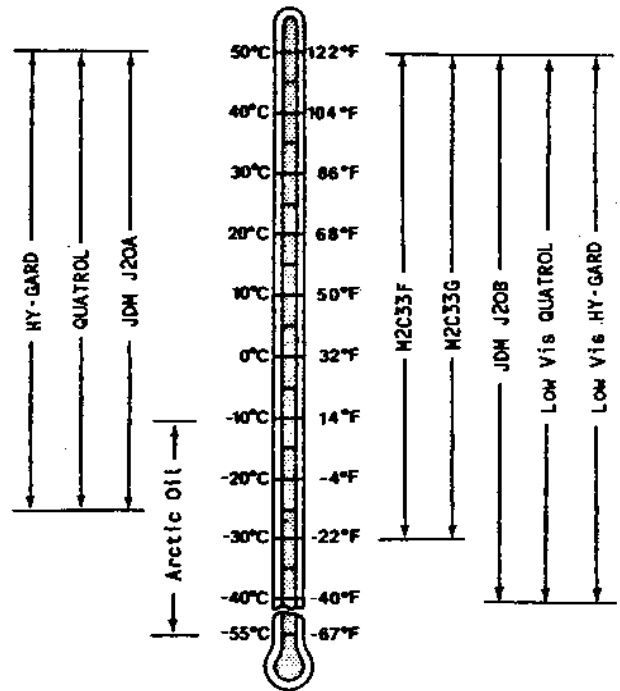

DX,HOIL2 -19-04JUN90

10  
20  
3  
TS244 -19-09NOV88

## EXTREME PRESSURE OR MULTIPURPOSE GREASE

Use grease based on the expected air temperature range during the service interval.

John Deere Moly High Temperature EP Grease and John Deere High Temperature EP Grease are recommended.

Other greases that may be used are:

- SAE Multipurpose EP Grease with 3 to 5 percent molybdenum disulfide.
- SAE Multipurpose EP Grease.
- Greases meeting Military Specification MIL-G-10924C may be used as arctic grease.

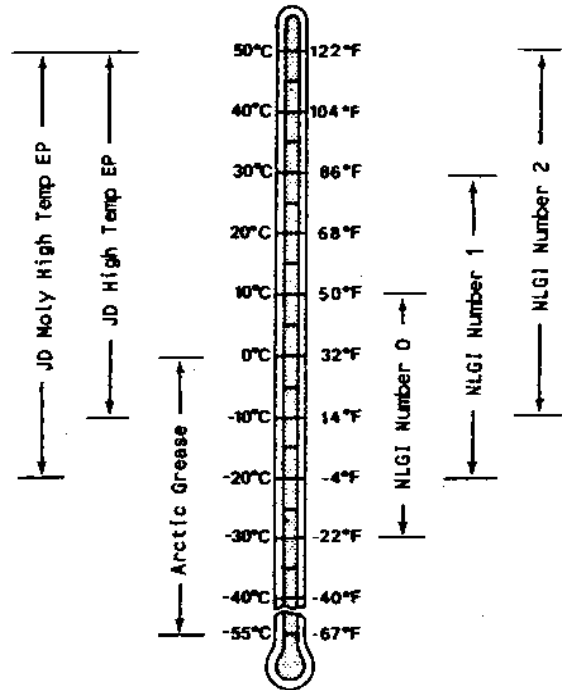

DX,GREA1 -19-05OCT90

TS248 -19-07OCT88

## **LUBRICANT STORAGE**

Your equipment can operate at top efficiency only if clean lubricants are used.

Use clean containers to handle all lubricants.

Store lubricants and containers in an area protected from dust, moisture, and other contamination.

DX,LUBST -19-04JUN90

## **ALTERNATIVE LUBRICANTS**

Additional information on cold weather operation is available from your John Deere dealer.

Conditions in certain geographical areas may require special lubricants and lubrication practices which do not appear in the operator's manual. If you have any questions, consult your John Deere dealer to obtain the latest information and recommendations.

MX,ALTER,A -19-15JAN91

## SERIAL NUMBERS

When working on machines or components that are covered by warranty, it is **IMPORTANT** that you include the machine's Product Identification Number and the component serial number on the warranty claim form.

The location of component serial number plates are shown below.

MX,1025FT,A4 -19-15JAN91

## PRODUCT IDENTIFICATION NUMBER LOCATION

The machine's 13 digit product identification number (A) is located on the side of the frame, at the rear of the machine.

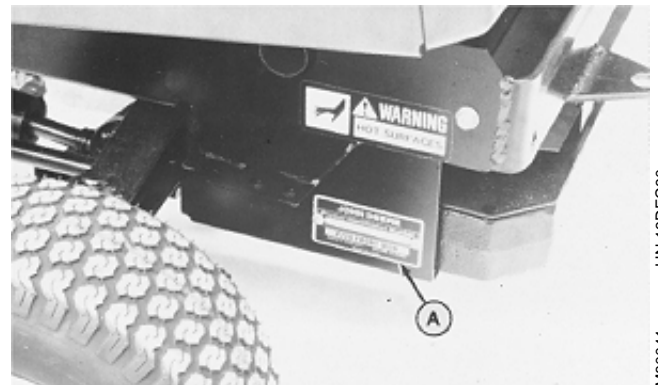

MX,1025GC,A1 -19-15JAN91

10  
25  
1

IM80041 -JUN-19DEC90

## ENGINE SERIAL NUMBER LOCATION

F710 engine serial number (A) is located on the left-hand side of blower housing.

F725 engine serial number (A) is located on the left-hand side of cooling air duct.

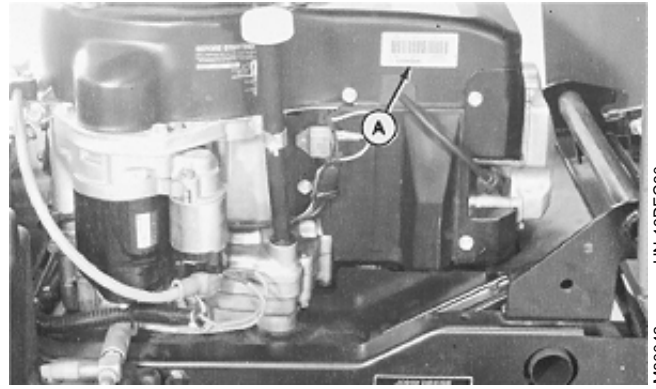

F710

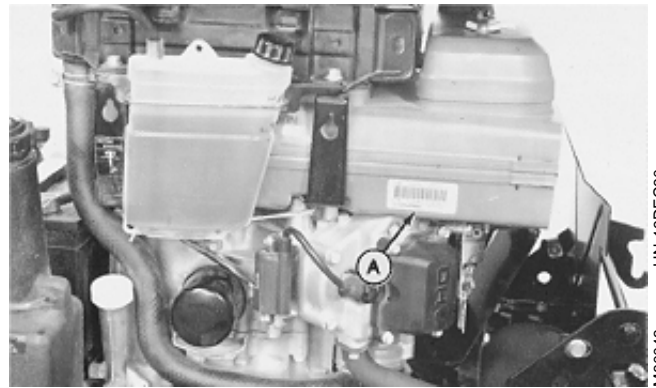

F725

MX,1025GC,A2 -19-15JAN91

## POWER STEERING VALVE SERIAL NUMBER LOCATION

The power steering valve serial number plate (A) is located on front of valve.

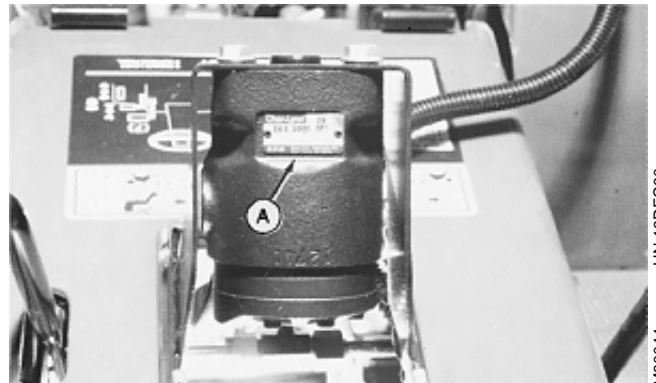

MX,1025GC,A3 -19-15JAN91

### HYDROSTATIC TRANSMISSION SERIAL NUMBER LOCATION

The hydrostatic transmission serial number plate (A) is located on the directional control shaft side of housing.

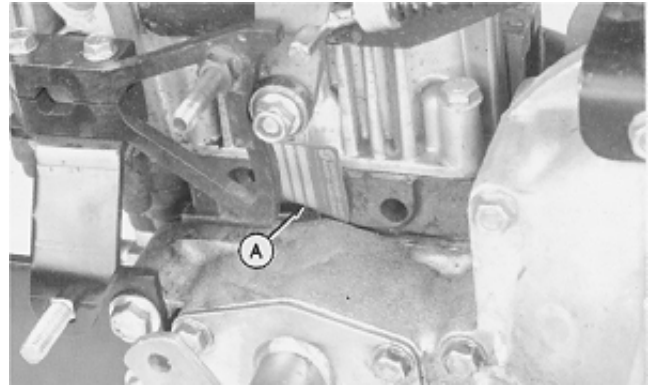

MX,1025GC,A4 -19-15JAN91

10  
25  
3  
M80045 -UN-19DEC90

### DIFFERENTIAL SERIAL NUMBER LOCATION

The differential serial number (A) is stamped on top of case, filter side.

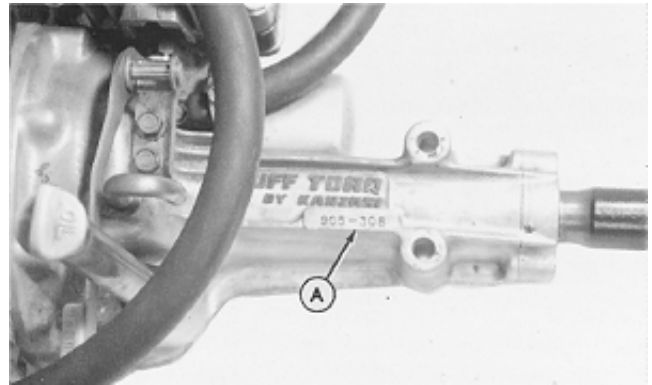

MX,1025GC,A5 -19-15JAN91

M80046 -UN-19DEC90

10  
25  
4

### PTO GEARBOX SERIAL NUMBER LOCATION

The PTO gearbox serial number plate (A) is located on gearbox cover plate.

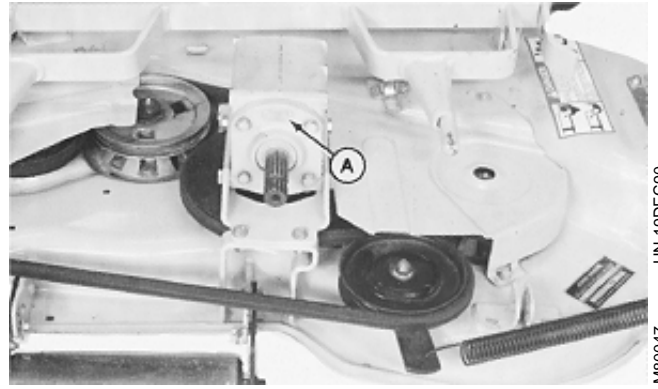

M80047 -UN-19DEC90

*Gearbox on Mower Deck*

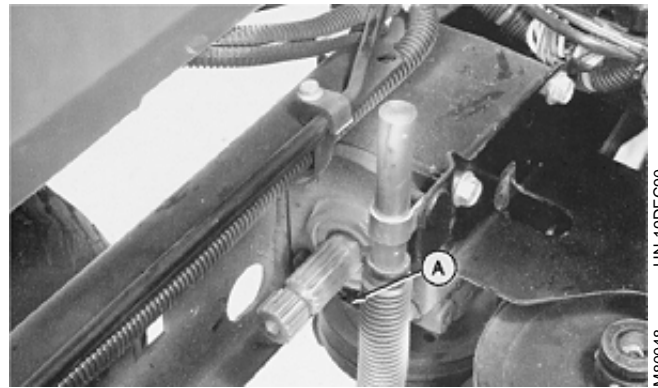

M80048 -UN-19DEC90

*Gearbox on Frame*

MX,1025GC,A6 -19-15JAN91

## MOWER DECK SERIAL NUMBER LOCATION

48 inch mower deck serial number plate (A) is located on the top right-hand side of deck.

54 inch mower deck serial number plate (A) is located on the top left-hand side of deck.

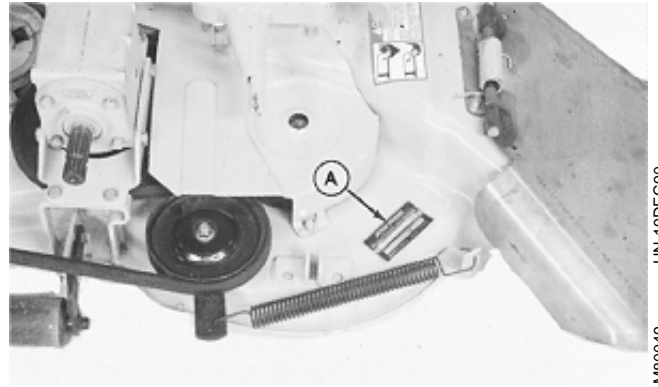

48 Inch Deck

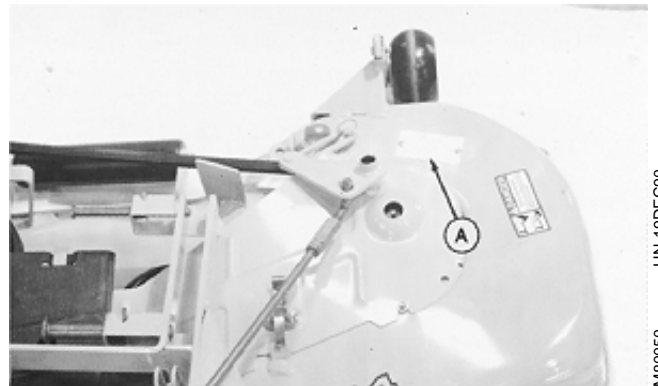

54 Inch Deck

MX,1025GC,A7 -19-15JAN91

The information covered in this group pertains to the features of each of the models of units covered in this Technical Manual. It can be used in addition to the normal advertising literature or may be of some help in determining the specific unit that is requiring service. A list of the available attachments and kits is also included.

## FEATURES & ATTACHMENTS

MX,1030GC,1 -19-15JAN91

## F710/F725 FRONT MOWERS

The 700 Series Front Mower line consists of the F710 and F725 models. These units use the same frame, drive train, hydraulic system, steering system and control system. The differences between the units are in the engines and mower decks.

- The F710 is powered by the 'K' Series FC540V engine and is equipped with a 48-Inch mowing deck.
- The F725 is powered by the 'K' Series FD590V engine and is equipped with a 54-Inch mowing deck.



Slide M49438

MX,1030GC,2 -19-15JAN91

## F710 FEATURES

The F710 Front Mower has the following features:

- John Deere 'K' Series FC540V single cylinder air cooled engine with 17.5 hp. (13 kw).
- New design, 48-Inch, 3-spindle mowing deck.
- Two pedal, foot controlled forward and reverse drive.
- Sundstrand hydrostatic transmission.
- Kansaki differential with diff-lock.
- Hydraulic power steering.
- Hydraulic lift for the mower or optional snowthrower with weight transfer feature.
- Large capacity, 7.0 gal. (26.5 L.) fuel tank with an easy to read fuel gauge.
- Indicator lamps, conveniently located in the steering pedestal, for engine oil pressure and battery charging systems.
- High back seat with 5 in. of fore and aft adjustment.



Slide M49433

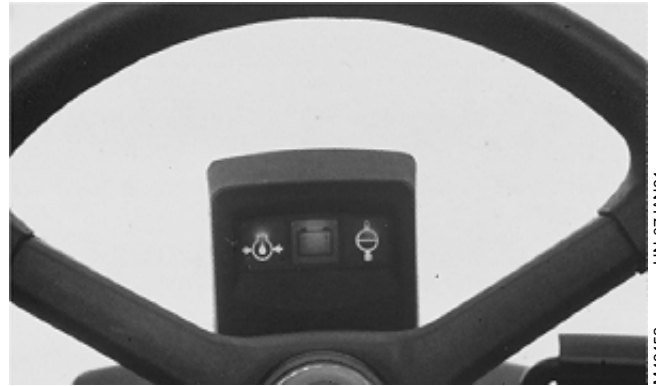

Slide M49452



Slide M49453

MX,1030GC,3 -19-15JAN91

10  
30  
2

M49433 -UN-07JAN91

M49452 -UN-07JAN91

M49453 -UN-07JAN91

## F725 FEATURES

The F725 Front Mower has the following features:

- John Deere 'K' Series FD590V twin cylinder liquid cooled engine with 20.0 hp. (15 kw).
- New design, 54-Inch, 3-spindle mowing deck.
- Dual pedal, foot controlled forward and reverse drive.
- Sundstrand hydrostatic transmission.
- Kansaki differential with diff-lock.
- Hydraulic power steering.
- Hydraulic lift for the mower or optional snowthrower with weight transfer feature.
- Large capacity, 7.0 gal. (26.5 l.) fuel tank with an easy to read fuel gauge.
- Indicator lamps, conveniently located in the steering pedestal, for engine oil pressure, engine coolant temperature, and battery charging systems.
- High back seat with 5 in. of fore and aft adjustment.



Slide M49435

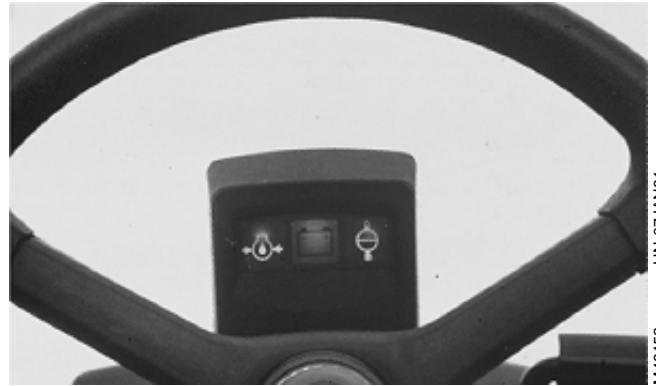

Slide M49452



Slide M49453

MX,1030GC,4 -19-15JAN91

## 'K' SERIES FC540V ENGINE FEATURES

The John Deere 'K' Series FC540V engine used in the F710 has the following specifications and features:

- 17.5 hp. (13 kw).
- Bore and stroke of 3.50 X 3.38 in. (89 X 86 mm).
- Displacement of 32.6 ci. (535 cc).
- Overhead valve, 4-stroke cycle design.
- Solid state, transistorized, magnito ignition system.
- Die-cast aluminum block, head, and crankcase with fins for cooling.
- Cast iron cylinder liner.
- Full pressure lubrication system with replaceable oil filter.
- Crankcase oil capacity of 1.7 qt. (1.6 l.).
- Two-stage air filter with paper dry type air cleaner and foam precleaner.
- Automatic compression release.

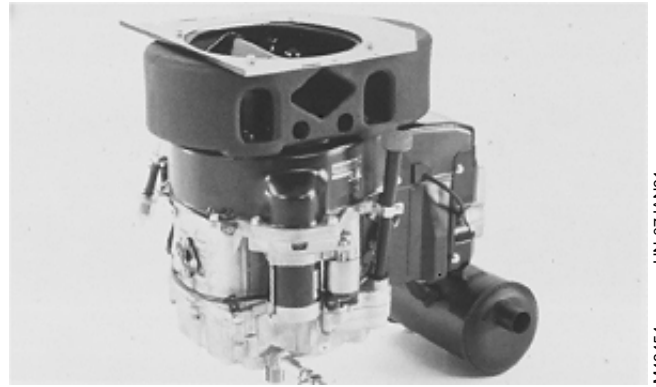

Slide M49454

M49454  
-UN-07-JAN91

MX,1030GC,5 -19-15JAN91

## 'K' SERIES FD590V ENGINE FEATURES

The John Deere 'K' Series FD590V engine used in the F725 has the following specifications and features:

- 20 hp. (15 kw).
- Bore and stroke of 2.90 X 2.68 in. (74 X 68 mm).
- Displacement of 35.7 ci. (585 cc).
- Overhead valve, 4-stroke cycle design.
- Solid state, transistorized, battery ignition system.
- Die-cast aluminum block, head, and crankcase with coolant passages.
- Cast iron cylinder liners.
- Full pressure lubrication system with replaceable oil filter.
- Crankcase capacity of 4 qt. (3.8 L.)
- Two-stage air filter with paper dry type air cleaner and foam precleaner.
- Cooling system capacity of 3.3 qt. (3.1 L.).

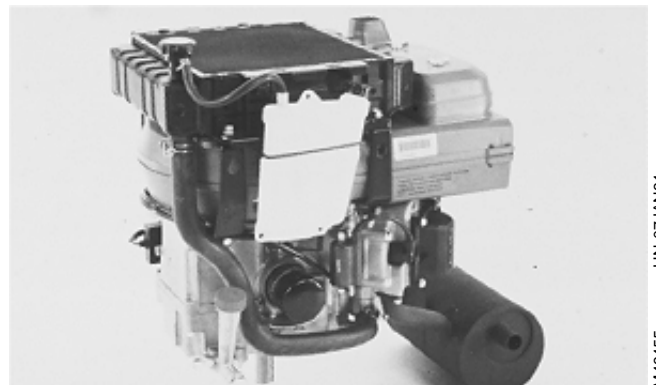

Slide M49455

M49455  
-UN-07-JAN91

MX,1030GC,6 -19-15JAN91

## POWER TRAIN FEATURES

The power train of the 700 Series Front Mounts has the following specifications and features:

- Sundstrand piston pump and motor hydrostatic transmission.
- Kansaki differential assembly with foot pedal operated differential lock.
- Dual right foot pedal control for forward and reverse operation of the transmission.
- Infinite variation of forward speed from 0.5 to 7.0 mph. (0.8 to 11.2 kph.).
- Infinite variation of reverse speed from 0.5 to 3.0 mph. (0.8 to 4.8 kph.).
- Gas shock installed in control linkage for smoother operation.
- Right foot operated brake system with expanding shoe and drum brake on the input shaft of the differential.
- Replaceable, hydrostatic/hydraulic oil filter on the differential.
- Hydrostatic/hydraulic oil cooler.

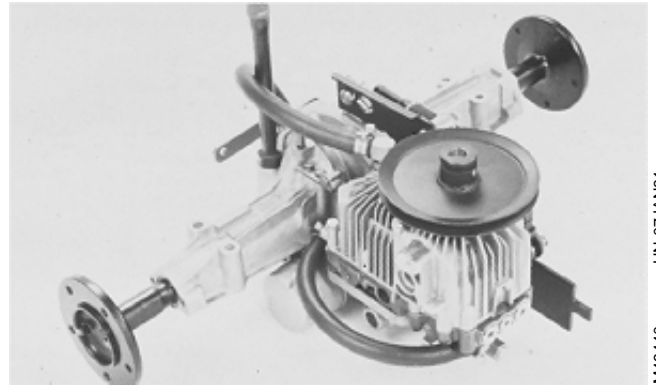

Slide M49440

10  
30  
5  
M49440 -UN-07JAN91

MX,1030GC,7 -19-15JAN91

## HYDRAULIC SYSTEM FEATURES

The hydraulic system of the 700 Series Front Mounts has the following specifications and features:

- Single control operated hydraulic valve for the attachment lift system with variable weight transfer function.
- Charge pump output of 2.85 gpm at 3600 rpm (10.8 L/min. at 3600 rpm.).
- Replaceable, hydrostatic/hydraulic oil filter on the differential.
- Hydrostatic/hydraulic oil cooler.
- System relief valve (located in steering valve) set at 525 psi (3620 kPh) to protect the hydraulic system components.

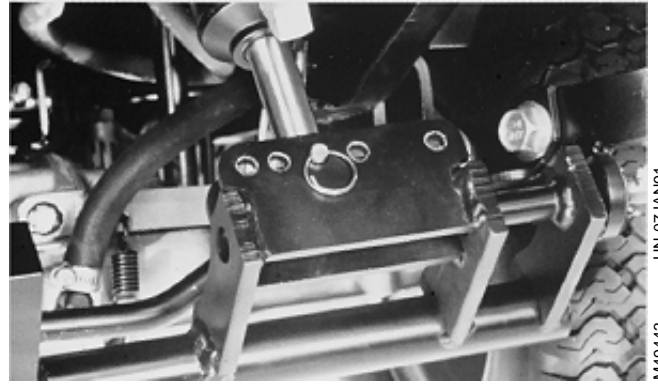

Slide M49443

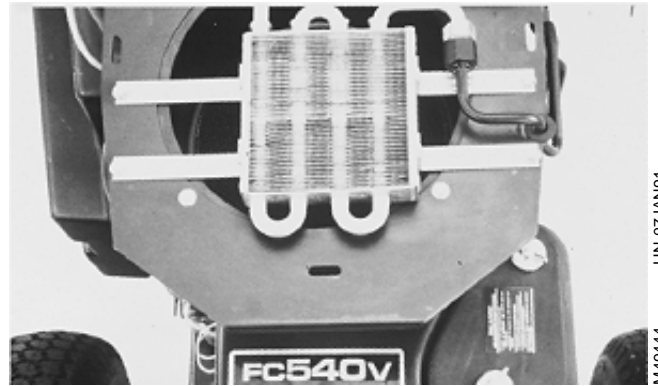

Slide M49444

MX,1030GC,8 -19-15JAN91

## FRAME FEATURES

The frame of the 700 Series Front Mounts has the following specifications and features:

- Fully welded.
- Full length 'C' channel side rails.
- Integrated 80 lb. (36.4 Kg.) ballast weight at rear of frame.
- Frame material 0.140 in. (3.6 mm) thick.
- Rear hitch standard.

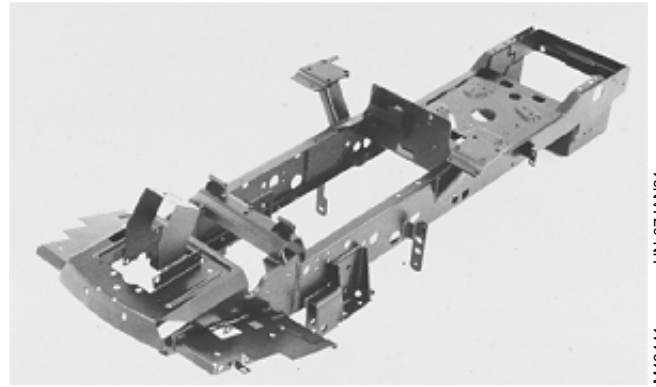

Slide M49441

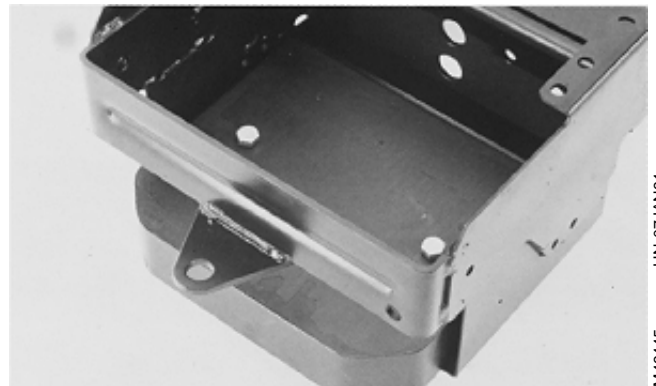

Slide M49445

MX,1030GC,9 -19-15JAN91

## STEERING SYSTEM FEATURES

The steering system of the 700 Series Front Mounts has the following specifications and features:

- Heavy duty forged axle.
- Replaceable pivot and spindle bushings.
- Horseshoe sub-frame for added support.
- Hydraulic power steering.
- Manual steering capability if there is a loss of hydraulic pressure.
- Turning radius of 10 in. (250 mm).
- Spindle shafts 1.0 in. (25.4 mm) diameter.

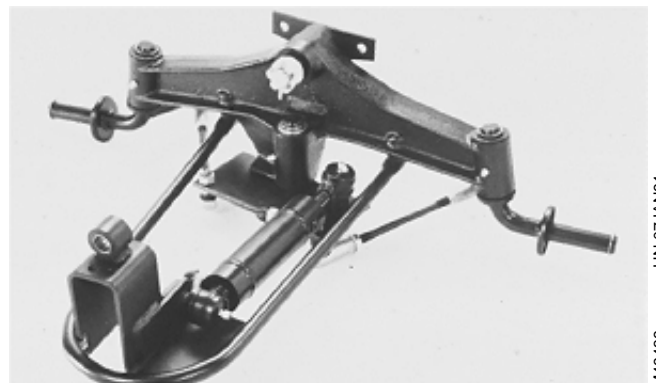

Slide M49439

MX,1030GC,10 -19-15JAN91

## MOWER DECK FEATURES

The 48-Inch and 54-Inch mower decks offer the following specifications and features:

- Easy installation and removal.
- One lever cutting height adjustment.
- Easy fore-and -aft adjustment.
- Easy side-to-side adjustment.
- Optional bolt on mower edge lips for various cutting conditions.
- Heavy duty blade spindles with grease fitting.
- Anti scalp wheels.

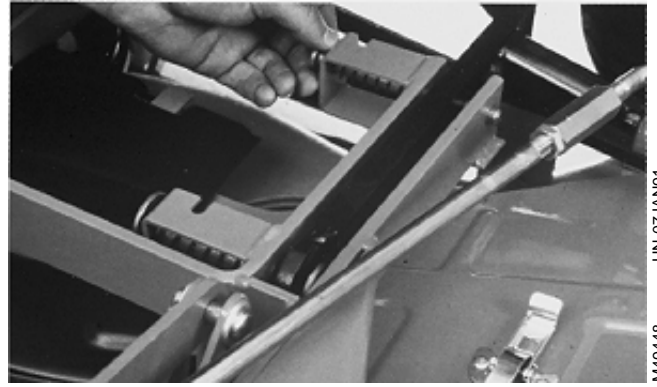

Slide M49448

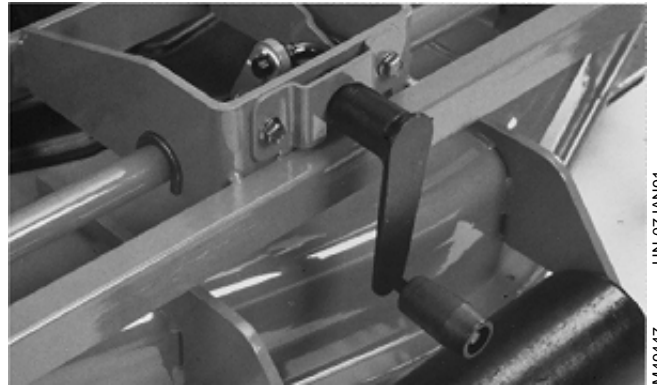

Slide M49447

MX,1030GC,11 -19-15JAN91

## OPTIONAL ATTACHMENTS & KITS

The following Attachments and Kits are available for the 700 Series Front Mowers:

- 46-Inch snowthrower.
- Side mounted material collection system.
- Bolt on mower edge lips for for various cutting conditions.
- Medium lift mower blades.
- Leaf cracker.
- Headlight kit.
- Rear weight kit for up to 180 lbs. (82 kg.) of additional ballast.
- Tire chains.
- Electric spout rotator kit for snowthrower.

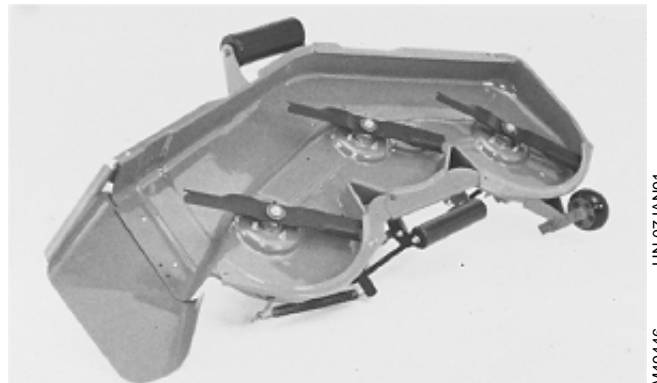

Slide M49446

MX,1030GC,12 -19-15JAN91

**Group 35**  
**Service Information Bulletin Listing**

There are no Service Information Bulletins issued at this time. Use this space to record any future bulletins as a reference.

MX,1035GC,A1 -19-15JAN91

10  
35  
1

# Section 20 ENGINE REPAIR—F710

## Contents

### Page

#### Group 05—Engine—FC540V

Engine Repair—Use CTM5 . . . . .	20-05-1
Other Materials . . . . .	20-05-1
Engine	
Remove . . . . .	20-05-1
Install . . . . .	20-05-3

#### Group 10—Muffler—F710

Remove and Install . . . . .	20-10-1
------------------------------	---------

## JOHN DEERE ENGINE REPAIR—USE CTM-5

For complete repair information the component technical manual (CTM) is also required.

Use the component technical manual in conjunction with this machine manual.



M22,2001G,1 -19-15JAN91

TS225  
-JUN-17-JAN89

20  
05

## OTHER MATERIAL

Number	Name	Use
PT569	John Deere NEVER-SEEZ <sup>®</sup> Lubricant	Apply to engine crankshaft.

*NEVER-SEEZ is a trademark of the Emhart Chemical Group.*

MX,2005FS,A1 -19-15JAN91

## REMOVE ENGINE

1. Disconnect negative (-) cable (A).
2. Remove hydrostatic oil cooler. (See Section 70, Group 15.)

*NOTE: Engine oil capacity is 2.0 L (4.2 U.S. pt).*

3. Drain engine oil.
4. Disconnect cable and wiring leads (C).
5. Disconnect wiring connectors (B and D).

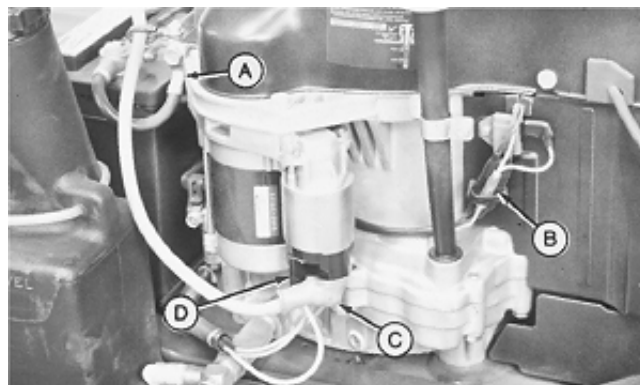

Left Side Shown

- A—Negative (-) Battery Cable
- B—Engine Wiring Connectors
- C—Starter Cable and Wiring Leads
- D—Starter Solenoid Wiring Connector

MX,2005GC,A1 -19-15JAN91

M80078  
-JUN-20DEC90

6. Turn fuel shutoff valve to OFF position.
7. Disconnect wiring connector (A).
8. Disconnect wiring leads (B and E).
9. Disconnect control cable (C).

**N** **CAUTION:** Gasoline vapor is explosive. Do not expose to spark or flame. Serious personal injury can result.

10. Disconnect fuel hose (D) from fuel pump. Close all openings using caps and plugs.
11. Remove muffler. (See Group 10.)

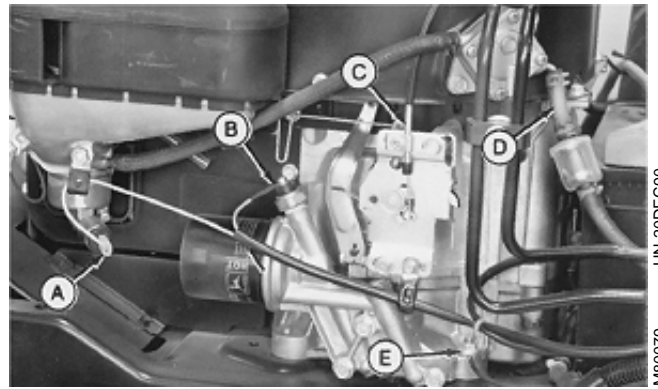

Right Side Shown

- A—Fuel Control Solenoid Wiring Connector
- B—Oil Pressure Sender Wiring Lead
- C—Throttle Control Cable
- D—Fuel Hose
- E—Ground Wiring Lead

MX,2005GC,A2 -19-15JAN91

12. Push idler sheave (B) toward left-hand side of machine.
13. Remove drive belt from transmission sheave (A).

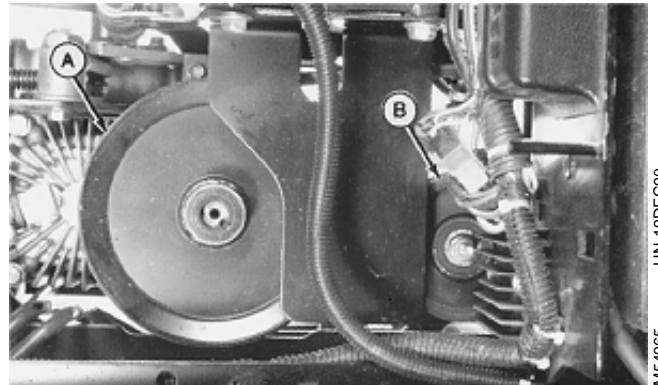

MX,2005GC,A3 -19-15JAN91



**Suggest:**

**If the above button click is invalid.**

**Please download this document**

**first, and then click the above link**

**to download the complete manual.**

**Thank you so much for reading**

14. Remove electric PTO clutch. (See Section 40, Group 15.)
15. Remove drive belt (C).
16. Remove sheave (A) and key.
17. Remove cap screws (B and D).
18. Remove engine.
19. Make repairs as necessary. (See CTM5.)

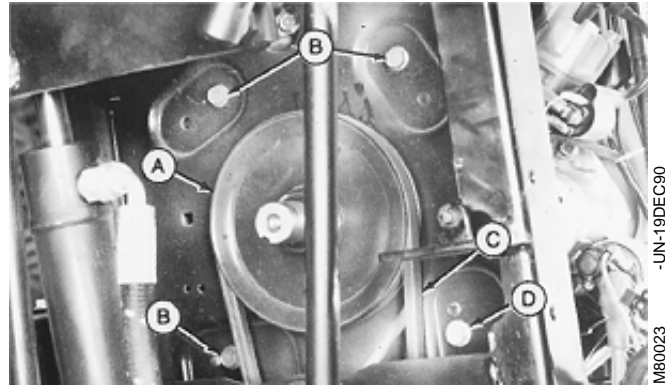

- A—Engine Drive Sheave
- B—Cap Screws (3 used)
- C—Drive Belt
- D—Cap Screw

MX,2005GC,A4 -19-15JAN91

## INSTALL ENGINE

1. Install engine.

*NOTE: Cap screw (D) is longer than cap screws (B) and must be installed in front right-hand mounting hole in frame.*

2. Install cap screws (B and D) loosely.
3. Apply NEVER-SEEZ lubricant or an equivalent to engine crankshaft.
4. Install key and sheave (A).
5. Install drive belt (C).
6. Install electric PTO clutch. (See Section 40, Group 15.)

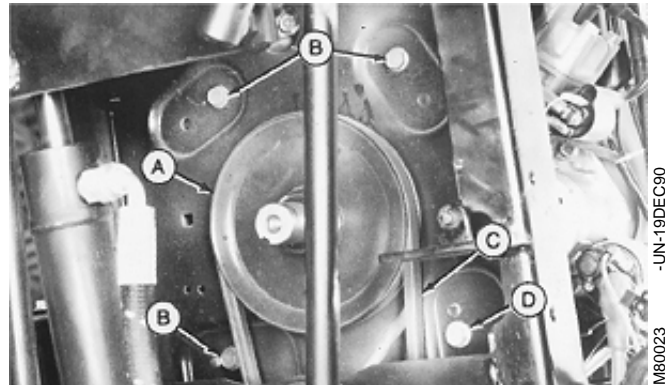

- A—Engine Drive Sheave
- B—Cap Screws (3 used)
- C—Drive Belt
- D—Cap Screw

MX,2005GC,A5 -19-15JAN91

**<https://www.ebooklibonline.com>**

Hello dear friend!

Thank you very much for reading.

Enter the link into your browser.

The full manual is available for immediate download.

**<https://www.ebooklibonline.com>**