



# 9950 Cotton Picker



JOHN DEERE

## TECHNICAL MANUAL

9950  
Cotton Picker

TM1349 (01Mar89) English

**TM1349 (01Mar89)**

LITHO IN U.S.A.  
ENGLISH

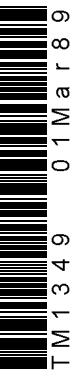

# Introduction

## FOREWORD

This manual is written for an experienced technician. Essential tools required in performing certain service work are identified in this manual and are recommended for use.

Live with safety: Read the safety messages in the introduction of this manual and the cautions presented throughout the text of the manual.



**This is the safety-alert symbol. When you see this symbol on the machine or in this manual, be alert to the potential for personal injury.**

Technical manuals are divided in two parts: repair and diagnostics. Repair sections tell how to repair the components. Diagnostic sections help you identify the majority of routine failures quickly.

Information is organized in groups for the various components requiring service instruction. At the beginning of each group are summary listings of all applicable essential tools, service equipment and tools, other materials needed to do the job, service parts kits, specifications, wear tolerances, and torque values.

Binders, binder labels, and tab sets can be ordered by John Deere dealers direct from the John Deere Distribution Service Center.

This manual is part of a total product support program.

## FOS Manuals-reference

### Technical Manuals-machine service

### Component Manuals-component service

*Fundamentals of Service (FOS) Manuals* cover basic theory of operation, fundamentals of troubleshooting, general maintenance, and basic types of failures and their causes. FOS Manuals are for training new personnel and for reference by experienced technicians.

*Technical Manuals* are concise guides for specific machines. Technical manuals are on-the-job guides containing only the vital information needed for diagnosis, analysis, testing, and repair.

*Component Technical Manuals* are concise service guides for specific components. Component technicals manuals are written as stand-alone manuals covering multiple machine applications.

## **JOHN DEERE DEALERS**

**Please remove this page and route through your service department.**

This is a complete revision for TM-1349, 9950 Cotton Picker.

Binder and tabs from old manual may be saved and used with this manual.

New pages are dated (Mar-89). Listed below is a brief explanation of "WHAT" was changed and "WHY" it was changed.

This manual was revised:

1. To show how to install the new lid parts required on 305 mm (12 in.) extensions.
2. To show replacement procedures and bleeding procedures for one filter fuel system.
3. To remove alternator repair information for both Motorola and Nippondenso. Refer to CTM-11 for repair and diagnostic information.
4. To show new repair information on hydrostatic drive and transmission because of addition of operator presence system.
5. To show new removal/installation and repair procedure for final drive axle.
6. To remove repair, operation and test information on 22.6 cm<sup>3</sup> (1.38 cu. in.) hydraulic pump. Refer to CTM-7 for repair and diagnostic information.
7. To revise main control valve repair information because of addition of an orifice to port "F".
8. To revise basket lift cylinder repair information because of removal of an orifice plate from rear cylinder and revised orifice diameter in front cylinder.
9. To include repair information for new height sensing control valve.
10. To include repair information for new full length sleeved picker bars.
11. To revise the cotton fan repair information. The fan shaft has been revised. The inlet cap screw torque has been increased, and rotor-to-inlet running clearance changed. The water pump drive sheave mounting to fan shaft has been revised.
12. To revise the operational checks to include the operator presence and by-pass system diagnostic procedures.
13. To provide test procedure for operator presence interlock module, adjustment procedure for picking unit engaged switch and a wiring diagram for the operator presence system.
14. To provide a new complete hydraulic and J.I.C. diagrams for machines above Serial No. 4001.

**<https://www.ebooklibonline.com>**

Hello dear friend!

Thank you very much for reading.

Enter the link into your browser.

The full manual is available for immediate download.

**<https://www.ebooklibonline.com>**

# Contents

## 9950 COTTON PICKER TECHNICAL MANUAL TM-1349 (MAR-89)

### SECTION AND GROUP CONTENTS

#### SECTION 10—GENERAL

- Group 00—Safety
- Group 05—General Specifications
- Group 10—Predelivery, Delivery and After-Sale Services
- Group 15—Fuels and Lubricants

#### SECTION 20—ENGINE REPAIR

- Group 05—Remove/Install Engine
- Group 10—Remove/Install Cooling System

#### SECTION 30—FUEL AND AIR REPAIR

- Group 05—Remove/Install Air Intake System
- Group 10—Remove/Install Diesel Fuel System
- Group 15—Control Linkage

#### SECTION 40—ELECTRICAL REPAIR

- Group 04—Starter Circuit Replacement
- Group 05—Motorola Charging Circuit
- Group 06—Nippondenso Charging Circuit
- Group 10—Monitor System
- Group 15—Lights, Instruments and Accessory Circuit
- Group 20—Connector Repair

#### SECTION 50—POWER TRAIN REPAIR

- Group 05—Eaton Hydrostatic Drive
- Group 06—Sundstrand Hydrostatic Drive
- Group 10—Transmission
- Group 14—Remove/Install Final Drive
- Group 15—Axle
- Group 16—Differential

#### SECTION 60—STEERING/BRAKES REPAIR

- Group 04—Remove/Install Steering Components
- Group 05—Steering Column
- Group 06—Steering Metering Pump
- Group 07—Steering Valve
- Group 08—Steering Motor
- Group 10—Brakes
- Group 14—Remove/Install Brake Accumulator
- Group 15—Brake Accumulator Repair

#### SECTION 70—HYDRAULIC REPAIR

- Group 05—Reservoir
- Group 10—Hydraulic Pump—22.6 cm<sup>3</sup> (1.38 cu. in.)
- Group 11—Hydraulic Pump—40 cm<sup>3</sup> (2.4 cu. in.)
- Group 15—Main Control Valve
- Group 20—Hydraulic Cylinders
- Group 25—Hydraulic Motors
- Group 30—Height Control
- Group 35—Pressure Control Valve (S.N. -4000)
- Group 40—Basket Compactor/Conveyor Control Valve

#### SECTION 80—AXLES AND WHEEL REPAIR

- Group 05—Guide Axle
- Group 10—Drive Wheel

#### SECTION 90—OPERATOR STATION REPAIR

- Group 05—Air Conditioning System
- Group 06—Air Conditioning System Service
- Group 10—Air Intake (Pressurizer) System
- Group 15—Heating System
- Group 20—Seat
- Group 25—Miscellaneous

#### SECTION 100—PICKING UNIT REPAIR

- Group 05—Picking Units Removal/Installation
- Group 10—Grid Bars and Pressure Plates
- Group 15—Spindles and Picker Bars
- Group 20—Picker Drums, Drive Shafts and Gears
- Group 25—Idler Gears and Bearings
- Group 30—Doffers
- Group 35—Moistener Column
- Group 40—Gear Cases, Universal Joints and Countershafts
- Group 45—Picking Unit Cabinets and Cam Tracks

#### SECTION 110—PICKING UNIT LUBRICATION SYSTEM REPAIR

- Group 05—Lubrication System
- Group 10—Transfer Pump

#### SECTION 120—WATER SYSTEM REPAIR

- Group 05—Water System

## SECTION AND GROUP CONTENTS—Continued

### SECTION 130—AIR SYSTEM REPAIR

Group 05—Air System

### SECTION 140—BASKET UNLOADING AND ME- TERING SYSTEM REPAIR

Group 05—Basket Unloading System

### SECTION 199—SPECIAL TOOLS

Group 05—Picking Unit Repair Tools

Group 10—Fabricated Tools

### SECTION 230—FUEL/AIR OPERATION AND TESTS

Group 05—Air Intake System

Group 10—Diesel Fuel System

### SECTION 240—ELECTRICAL OPERATION AND TESTS

Group 05—System Operational Checks

Group 10—Electrical Diagnosis

Group 15—Electrical System Checks

Group 20—Electrical System Adjustments

Group 25—Electrical System Diagrams

### SECTION 250—POWER TRAIN OPERATION AND TESTS

Group 05—Eaton Hydrostatic Drive System

Group 06—Sundstrand Hydrostatic Drive System

Group 10—Transmission

Group 15—Axle and Differential

### SECTION 260—STEERING/BRAKES OPERATION AND TESTS

Group 05—Steering

Group 10—Brakes

### SECTION 270—HYDRAULIC OPERATION AND TESTS

Group 05—Hydraulic System

Group 10—Hydraulic Pump

Group 15—Main Control Valve

Group 20—Hydraulic Cylinders

Group 25—Hydraulic Motors

Group 30—Height Control

Group 35—Pressure Control Valve

Group 40—Basket Compactor/Conveyor Control Valve

### SECTION 290—OPERATOR STATION OPERATION AND TESTS

Group 05—Air Conditioning System Operation

Group 10—Air Conditioning System Diagnosis and Tests

Group 15—Air Intake (Pressurizer) System

Group 20—Heating System

### SECTION 300—PICKING UNIT OPERATION AND TESTS

Group 05—Picking Unit System

### SECTION 310—PICKING UNIT LUBRICATION SYS- TEM OPERATION AND TESTS

Group 05—Lubrication System

### SECTION 320—WATER SYSTEM OPERATION AND TESTS

Group 05—Water System

### SECTION 330—AIR SYSTEM OPERATION AND TESTS

Group 05—Air System

### SECTION 399—SPECIAL TOOLS

Group 05—Purchased Tools

*All information, illustrations and specifications contained in this technical manual are based on the latest information available at the time of publication. The right is reserved to make changes at any time without notice.*

COPYRIGHT® 1988  
DEERE & COMPANY  
Moline, Illinois  
All rights reserved  
A John Deere ILLUSTRATION™ Manual  
1986 and 1988

N01;0000 -AC 060389

# Section 10 GENERAL

## CONTENTS

|   | Page     |   | Page     |
|---|----------|---|----------|
| <b>GROUP 00—Safety</b> . . . . .                                  | 10-00-1  | Install Basket Lid Parts                                  |          |
|   |          | 305 mm (12 in.) Extension . . . . .                       | 10-10-48 |
|   |          | 610 mm (24 in.) Extension . . . . .                       | 10-10-52 |
| <b>GROUP 05—General Specifications</b>                            |          | Install Basket Lid On Conveyor Basket . .                 | 10-10-52 |
| Specifications . . . . .  | 10-05-1  | Connect Basket Lift Lever . . . . .                       | 10-10-54 |
| Dimensions . . . . .  | 10-05-4  | Install Mud Scrapers . . . . .                            | 10-10-55 |
| Serial Numbers . . . . .  | 10-05-6  | Final Assembly Checks . . . . .                           | 10-10-55 |
| <b>GROUP 10—Predelivery, Delivery and<br/>After-Sale Services</b> |          | Check Monitor System (Truck Shipment<br>Only) . . . . .   | 10-10-55 |
| Changing Row Spacing . . . . .                                    | 10-10-1  | Monitor System Bulb Check . . . . .                       | 10-10-56 |
| Install Outer Picking Units (Truck<br>Shipment Only) . . . . .    | 10-10-1  | Drum Rotation Monitor Check . . . . .                     | 10-10-56 |
| Attach Stalklifters . . . . .                                     | 10-10-9  | Adjust Fan Switch . . . . .                               | 10-10-58 |
| Install Water Pump Belt . . . . .                                 | 10-10-10 | Adjust Unit Door Switches . . . . .                       | 10-10-59 |
| Install Lid on Standard Basket Without<br>Extension . . . . .     | 10-10-11 | Operator's Platform Controls<br>and Instruments . . . . . | 10-10-63 |
| Install Lid Lift Linkage on Standard<br>Basket . . . . .          | 10-10-13 | Monitor Display Panel . . . . .                           | 10-10-64 |
| Remove Lid to Install Basket Extension . .                        | 10-10-13 | Indicators, Gauges and Switches . . . . .                 | 10-10-64 |
| Install Standard Basket Extension . . . . .                       | 10-10-15 | Cab Roof Controls . . . . .                               | 10-10-65 |
| Install Lid on Standard Basket With<br>Extensions . . . . .       | 10-10-19 | Run-In Engine and Picking Units . . . . .                 | 10-10-66 |
| Install Upper Door on Standard<br>Extension . . . . .             | 10-10-21 | Adjust Picking Units . . . . .                            | 10-10-67 |
| Add Liquid Ballast to R.H. Drive<br>Tire (Non-Conveyor) . . . . . | 10-10-24 | Check Machine Appearance . . . . .                        | 10-10-67 |
| Fold-Out and Install Conveyor Parts<br>On Baskets . . . . .       | 10-10-25 | Temporary Storage . . . . .                               | 10-10-69 |
| Assemble and Install Conveyor Chains . .                          | 10-10-31 | Dealer Predelivery Service . . . . .                      | 10-10-70 |
| Assemble and Install Upper Conveyor<br>Drive Parts . . . . .      | 10-10-31 | Delivery Service After-Sale Inspection . .                | 10-10-71 |
| Install Basket Extension and Conveyor<br>Fillers . . . . .        | 10-10-34 | <b>GROUP 15—Fuels and Lubricants</b>                      |          |
| Assemble and Install Metering Bar,<br>Chain and Shield            |          | Fuel . . . . .  | 10-15-1  |
| 305 mm (12 in.) Extension . . . . .                               | 10-10-40 | Engine Oil . . . . .                                      | 10-15-2  |
| 610 mm (24 in.) Extension . . . . .                               | 10-10-44 | Engine Coolant . . . . .                                  | 10-15-3  |
| Adjust Conveyor Unloading Chains . . . .                          | 10-10-46 | Transmission—Hydraulic Oils . . . . .                     | 10-15-6  |
| Install Duct Ladder Extension . . . . .                           | 10-10-48 | Picker Bar and Spindle Lubricants . . . . .               | 10-15-6  |
|   |          | Grease . . . . .  | 10-15-7  |
|   |          | Lubrication . . . . .                                     | 10-15-8  |

### HANDLE FLUIDS SAFELY—AVOID FIRES

When you work around fuel, do not smoke or work near heaters or other fire hazards.

Store flammable fluids away from fire hazards. Do not incinerate or puncture pressurized containers.

Make sure machine is clean of trash, grease, and debris.

Do not store oily rags; they can ignite and burn spontaneously.



AB6;TS227 053;FLAME 050188

### PREVENT BATTERY EXPLOSIONS

Keep sparks, lighted matches, and open flame away from the top of battery. Battery gas can explode.

Never check battery charge by placing a metal object across the posts. Use a volt-meter or hydrometer.

Do not charge a frozen battery; it may explode. Warm battery to 16°C (60°F).



AB6;TS204 053;SPARKS 280688

### PREPARE FOR EMERGENCIES

Be prepared if a fire starts.

Keep a first aid kit and fire extinguisher handy.

Keep emergency numbers for doctors, ambulance service, hospital, and fire department near your telephone.

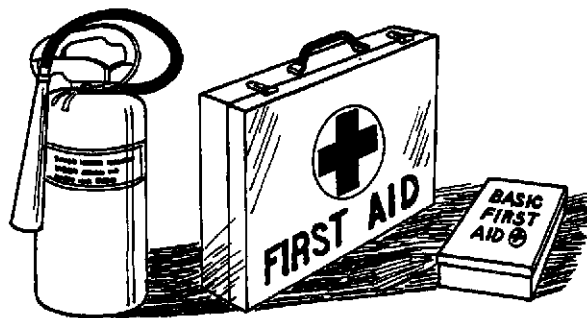

AB6;TS186 053;FIRE2 080785

## PREVENT ACID BURNS

Sulfuric acid in battery electrolyte is poisonous. It is strong enough to burn skin, eat holes in clothing, and cause blindness if splashed into eyes.

Avoid the hazard by:

1. Filling batteries in a well-ventilated area.
2. Wearing eye protection and rubber gloves.
3. Avoiding breathing fumes when electrolyte is added.
4. Avoiding spilling or dripping electrolyte.
5. Use proper jump start procedure.

If you spill acid on yourself:

1. Flush your skin with water.
2. Apply baking soda or lime to help neutralize the acid.
3. Flush your eyes with water for 10-15 minutes. Get medical attention immediately.

If acid is swallowed:

1. Drink large amounts of water or milk.
2. Then drink milk of magnesia, beaten eggs, or vegetable oil.
3. Get medical attention immediately.

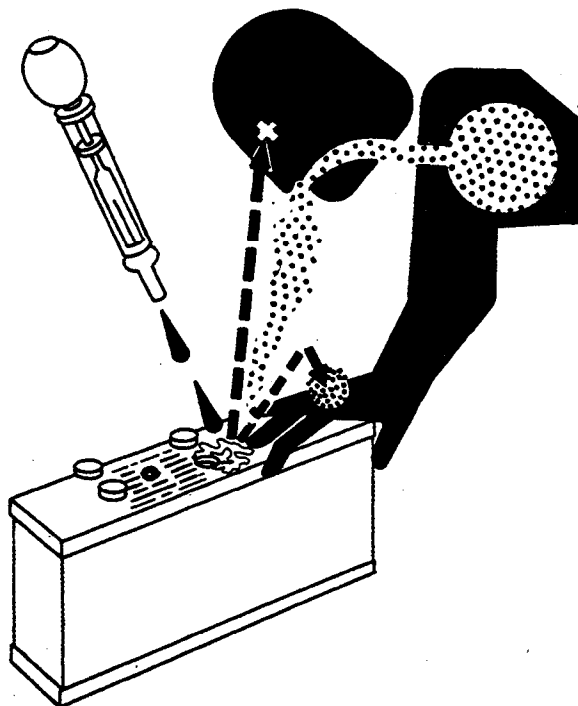

AB6;TS203 053;POISON 211287

## AVOID HIGH-PRESSURE FLUIDS

Escaping fluid under pressure can penetrate the skin causing serious injury. Relieve pressure before unhooking hydraulic or other lines. Tighten all connections before applying pressure. Keep hands and body away from pinholes and nozzles which eject fluids under high pressure. Use a piece of cardboard to search for leaks.

If ANY fluid is injected into the skin, it must be surgically removed within a few hours by a doctor familiar with this type injury or gangrene may result.



AB6;X9811 053;FLUID 180987

## AVOID CONTACT WITH ENGAGED PICKING UNIT

If service is required with engaged picking units, avoid contact with moving parts. Moving parts can puncture or dismember body parts, or cause death.

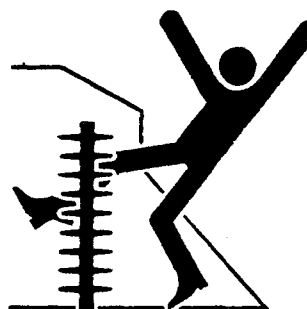

068;N39613 N01;1000K -080289

### PARK MACHINE SAFELY

Before working on the machine:

- Lower all equipment to the ground.
- Stop the engine and remove the key.
- Disconnect the battery ground strap.
- Hang a "DO NOT OPERATE" tag in operator station.

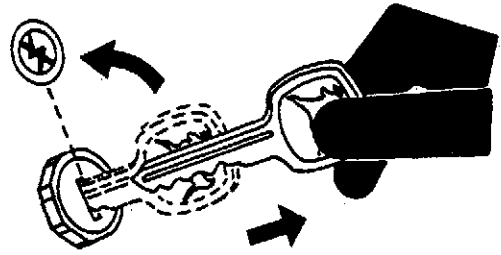

AB6;TS230 053;PARK 050188

- Look overhead for electric lines or low ceiling.

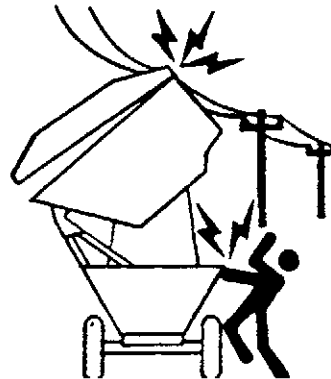

068;N39671 N01;;1000L -080289

### SUPPORT MACHINE PROPERLY

Always lower the attachment or implement to the ground before you work on the machine. If you must work on a lifted machine or attachment, securely support the machine or attachment.

Do not support the machine on cinder blocks, hollow tiles, or props that may crumble under continuous load. Do not work under a machine that is supported solely by a jack. Follow recommended procedures in this manual.

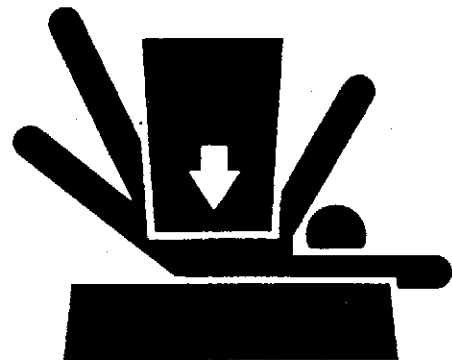

AB6;TS229 053;LOWER 211287

### WEAR PROTECTIVE CLOTHING

Wear close fitting clothing and safety equipment appropriate to the job.

Prolonged exposure to loud noise can cause impairment or loss of hearing.

Wear a suitable hearing protective device such as earmuffs or earplugs to protect against objectionable or uncomfortable loud noises.

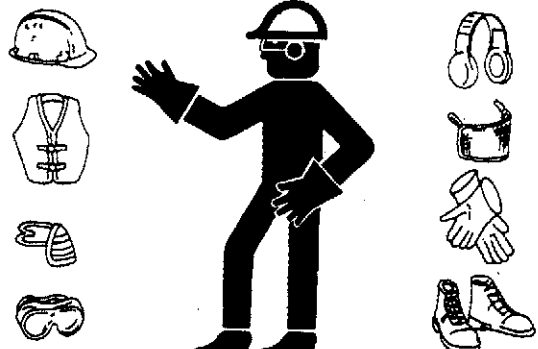

AB6;TS206 053;WEAR 230487

## CLEAN HYDROSTATIC DRIVE UNIT

Clean outside of hydrostatic back-to-back unit thoroughly. Either steam clean or wash with solvent. Clean surrounding area so dirt will not get into system when hoses and lines are disconnected.

**IMPORTANT:** Always use clean tools and keep open surfaces free of dirt and foreign matter. Cleanliness is essential when servicing the hydrostatic system.

N01;;5026 A 091084



**CAUTION:** Escaping fluid under pressure can penetrate the skin causing serious injury. Relieve pressure before disconnecting hydraulic or other lines. Tighten all connections before applying pressure. Keep hands and body away from pinholes and nozzles which eject fluids under high pressure. Use a piece of cardboard or paper to search for leaks. Do not use your hand.

If ANY fluid is injected into the skin, it must be surgically removed within a few hours by a doctor familiar with this type injury or gangrene may result.

**IMPORTANT:** When disconnecting a line, hose, or transfer tube from a hydrostatic component, always mark end and port from which it was removed so that it can be connected to proper port when reassembling.

Also, when disconnecting a line, hose, or transfer tube from a component, always plug them and component to keep dirt out of system. Use a plastic plug or plastic bag - never a cloth. Cloth contains lint which can damage hydrostatic system.

High pressure hoses have clamp-type bolted fittings with O-rings. When this type of fitting is disassembled, inner surfaces must be cleaned thoroughly and new O-rings installed. This is to insure a tight seal and reduce possibility of leakage.

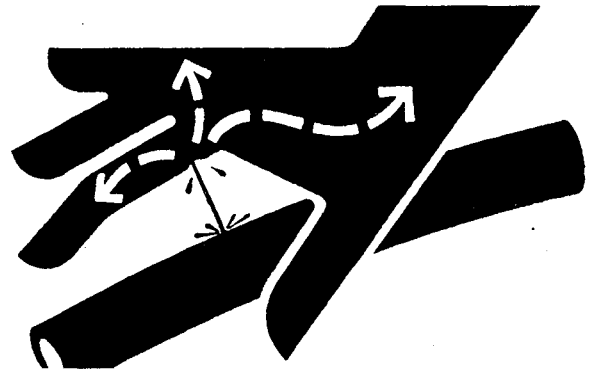

9A2;X9811 N01;;5005 GA 080385

## REMOVE HYDROSTATIC UNIT

1. Remove plant tunnel shields from either side.
2. Using locking pliers, or two pieces of metal and C-clamp; clamp off hydrostatic supply hose from bottom of hydrostatic reservoir to charge pump.
3. Disconnect control linkage (A).
4. Disconnect safety start switch wire (B) and unthread from pump.
5. Disconnect and cap hydrostatic lines (C). Plug holes in hydrostatic drive unit. Place plastic bags over ends of lines to keep dirt out of system. Secure with rubber bands.
6. Loosen steel line clamp along engine side rail and slide line back out of mounting angle grommet (F).
7. Disconnect U-joint (D) from charge pump drive sheave.
8. Unscrew U-joint coupling and remove front half of driveline.
9. Loosen charge pump drive belt (E) and remove.

A—Control Linkage  
B—Safety Start Switch Wire  
C—Hydraulic Lines  
D—U-Joint  
E—Charge Pump Drive Belt  
F—Mounting Angle Grommet

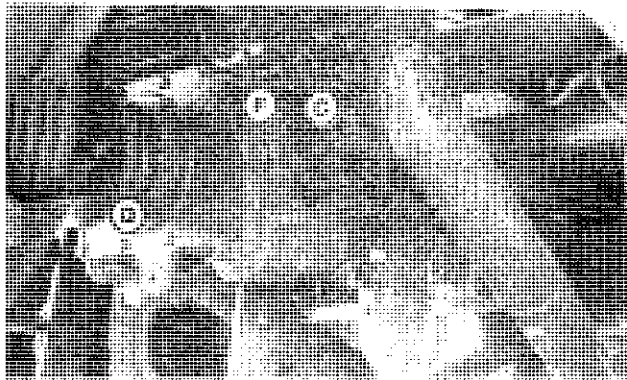
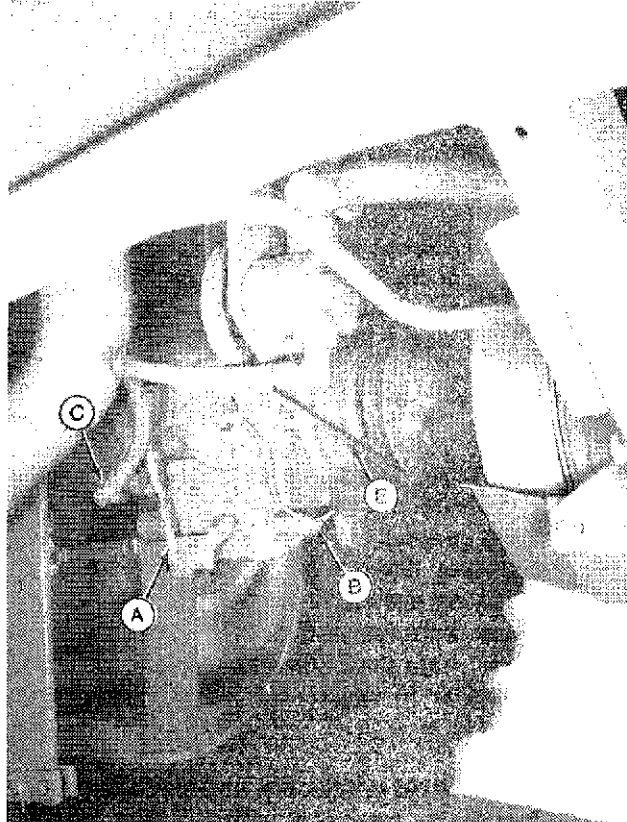

9A2;N85274 AC2 N84156 E2 N01;5005 GN 140486

10. Loosen lubrication pump drive belt (A) by loosening screws (B) and adjusting bolt (C). Remove belt.

11. Remove charge pump and lubrication pump drive sheave, cotter pin, slotted nut, and key.

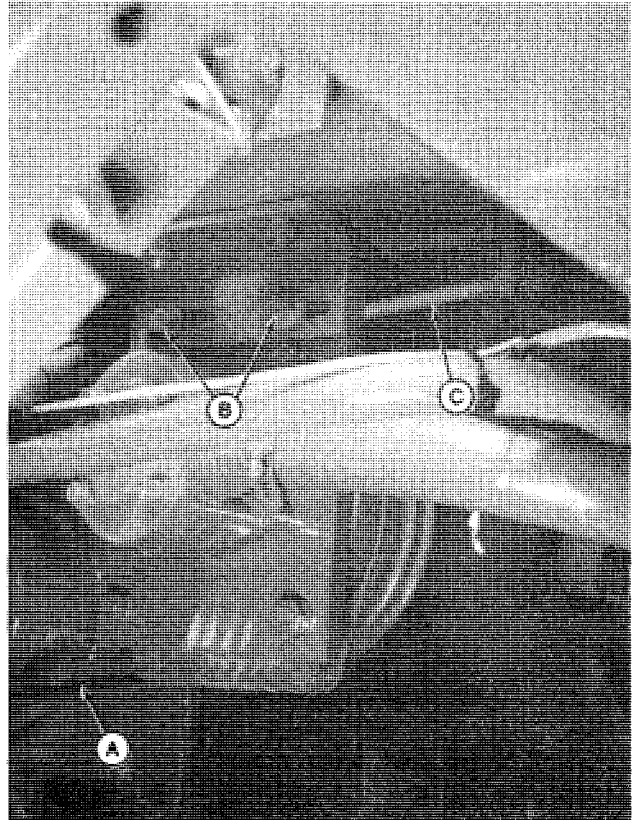

9A2;N85274 W2 N01;;5005 GO 140486

12. Position 341 kg (750 lb) service jack (A) with adapter under unit and attach to pump bracket.

**⚠ CAUTION: Combined unit weighs approximately 123 kg (270 lb). Use care in handling to avoid personal injury.**

13. Remove four pump-to-transmission attaching bolts.

14. Remove pump-to-angle mounting bolts and angle-to-main frame mounting bolts.

15. Slide unit towards rear, then lower.

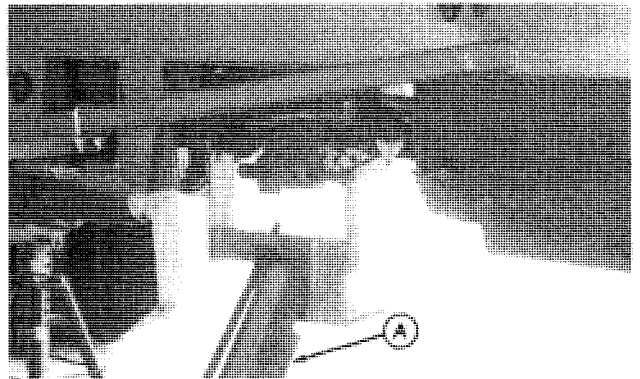

9A2;N80143 C2 N01;;5005 GP 150486

## SEPARATE HYDROSTATIC UNIT

1. Before separating the unit, scribe a line (A) across the motor housing flange, center section, and pump housing to assure correct reassembly. It is possible to attach the motor 180 degrees off of its correct location. This would give opposite rotation to the system.

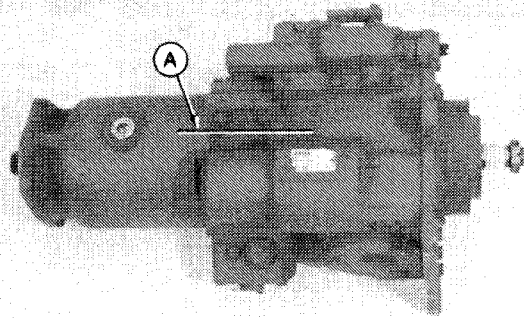

9A2;N84172 N1 N01;;5005 GQ 150486

2. Set hydrostatic unit on wood support block with motor (A) on top.



**CAUTION: The approximate weight of motor is 41 kg (90 lb).**

3. Remove center section-to-pump hex. socket head screws with JDG-352 Wrench (B).

4. Lift-off center section and motor.

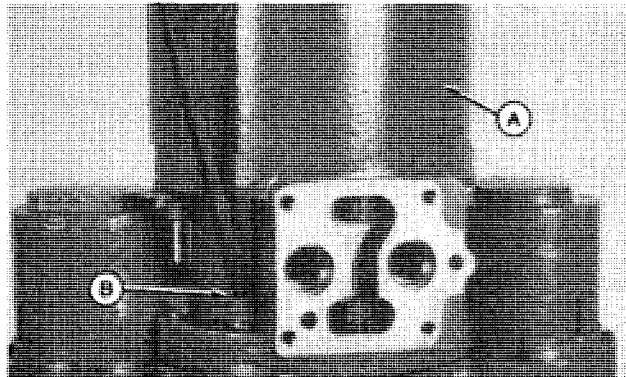

9A2;N37845 N01;;5005 GR 150486

5. Remove pump and set motor with center section on wood block.

6. Remove valve plate (A). The bearing plate may also come off at same time.

If necessary to pry plates apart, insert a small screwdriver in oil drain slots of valve plate. Carefully pry valve plate away from bearing plate.

7. Wrap plates separately in clean paper.

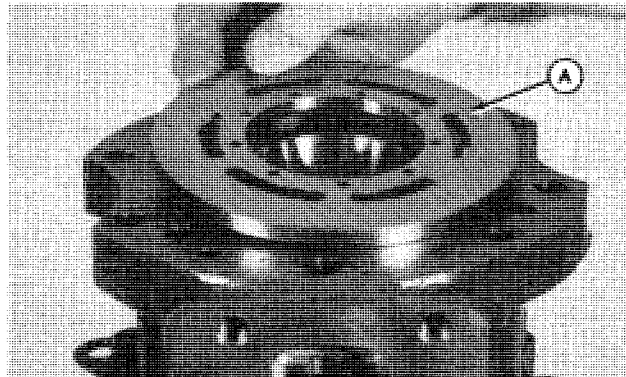

9A2;N37846 N01;;5005 GS 150486

8. Remove center section-to-motor hex. socket head screws using JDG-352 Wrench (A).

9. Lift center section off motor.

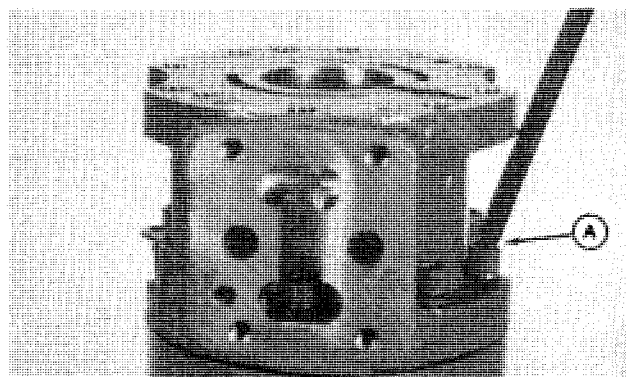

9A2;N37847 N01;;5005 GS1 150486

10. Remove motor valve plate (A).

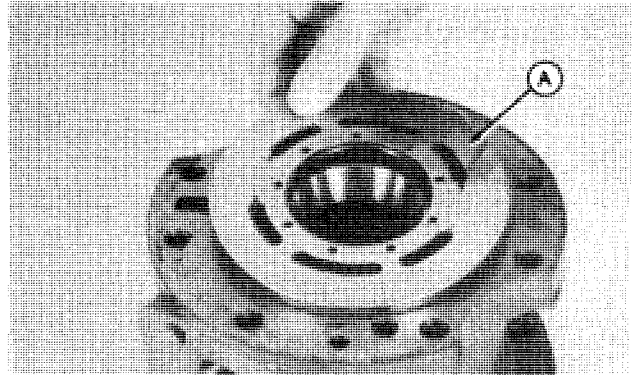

9A2;N37848 N01;;5005 GT 150486

11. The pump and motor valve plates are not interchangeable. The motor valve plate has four metering slots (A) and pump plate has only two slots (B).

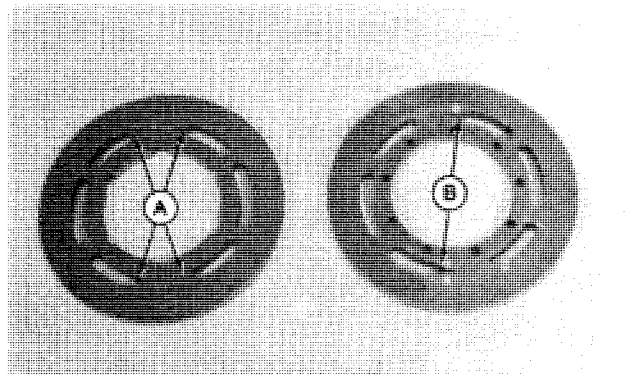

9A2;N84170 Q1 N01;;5005 GU 150486

## DISASSEMBLE MOTOR

1. Clean dirt out of shaft seal area with a spray cleaner, such as SCOTCH 3M No. 1606 Electrical Contact Cleaner or if not available, PERMATEX Gasket Remover No. 81110.

**IMPORTANT: Do not use solvent from parts cleaning tank. This solvent may be contaminated and defeat the purpose of cleaning shaft area.**

2. Remove snap ring (A).

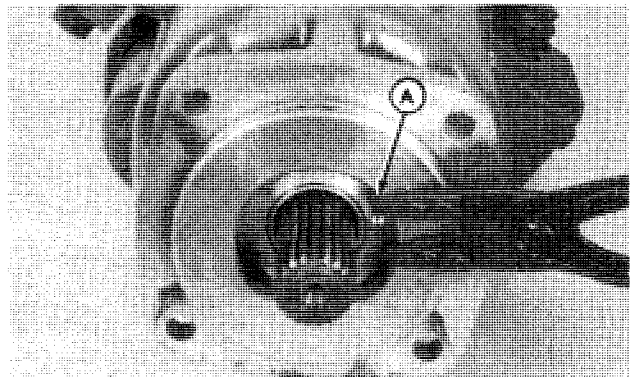

9A2;N37849 N01;;5005 -GV 180189

Eaton Hydrostatic Drive/Disassemble Motor

3. Remove stationary seal using a 1/4 x 20 UNC bolt (A).

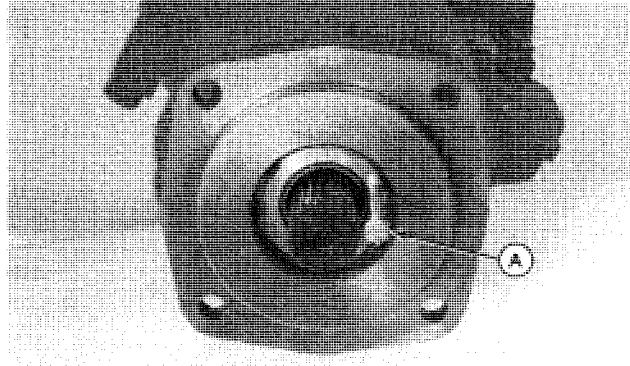

9A2;N84172 P1 N01;;5005 -JM 240987

4. Remove rotating seal using JDG-351 Seal Remover (A).  
Be careful not to scratch sealing surface.

5. Remove O-ring if it did not come out with rotating seal.

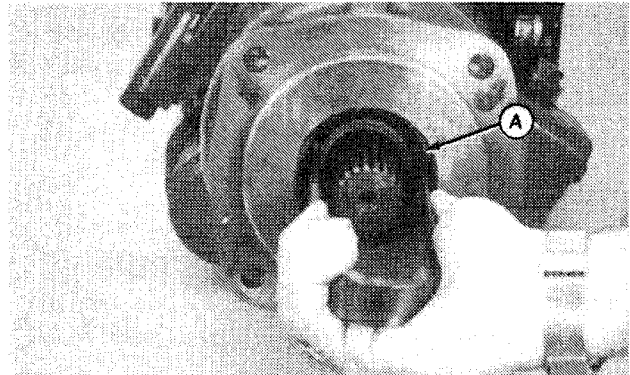

9A2;N37850 N01;;5005 -JN 240987

6. Inspect seal parts for nicks, scratches, or other damage.  
Replace all damaged parts. Install new O-rings.

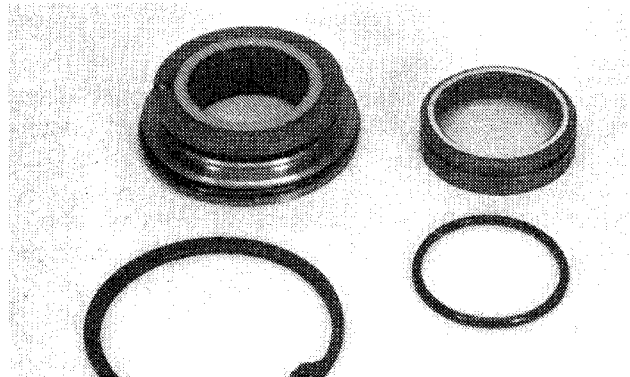

9A2;H50395 N01;;5005 -JO 240987

7. Remove gasket (A) and bearing plate (B), if not already removed.

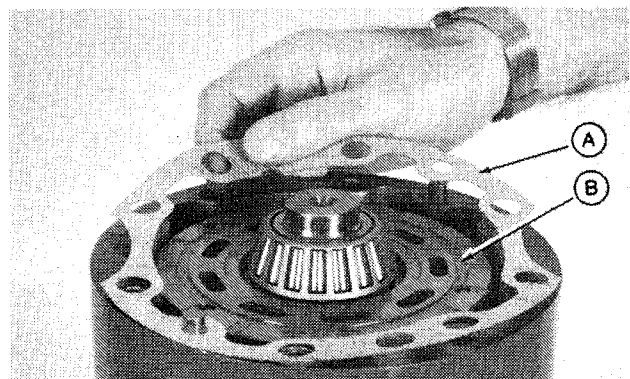

9A2;H50432 N01;;5005 -JP 240987

8. Protect cylinder barrel with clean paper or cloth before pulling bearing.
9. Pull rear bearing using puller (A) and hardened washer or steel ball (B).

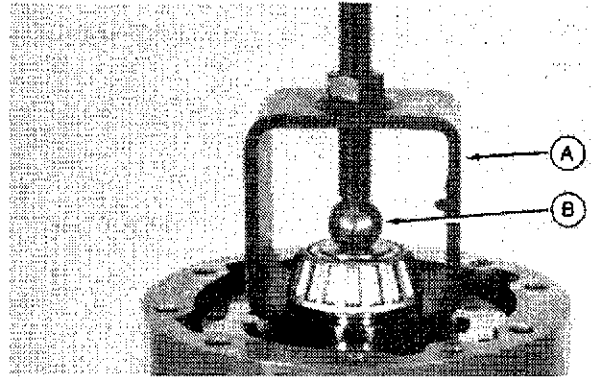

9A2;H50433 N01;5005 -GW 250987

10. Lay motor on its side and slide out cylinder barrel (A) with ball guide, pistons, and piston retainer.

The cylinder barrels and pistons must not be switched between the pump and motor. Also, do not switch pistons from one cylinder barrel to another.

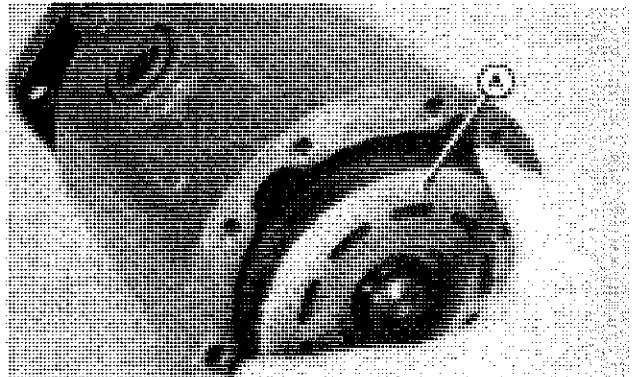

9A2;M37851 N01;5005 -JQ 240987

11. Remove ball guide (A).
12. Remove nine pistons (B) with retainer (C). Protect face of slippers. Wrap parts in clean paper.
13. Remove ball guide pins (D) and bearing plate index pins (E).

A—Ball Guide  
B—Pistons  
C—Retainer

D—Ball Guide Pins (6)  
E—Bearing Plate Pins (2)

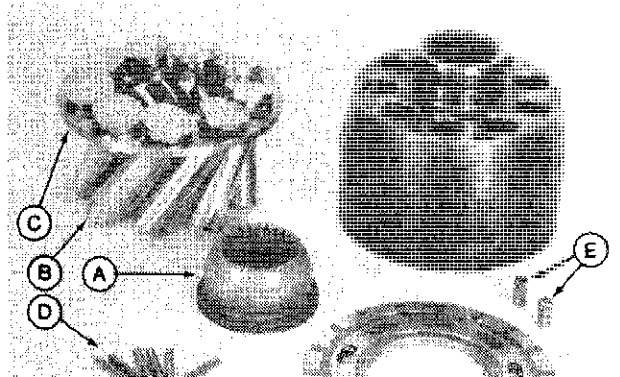

9A2;H50435 N01;5005 -JR 240987

14. If spring (A) appears damaged or contaminated, it must be removed to clean the cylinder barrel. Contamination collects in the spring bore of barrel and cannot be flushed out with spring in place.
15. To remove spring, use a press to compress spring and spring retaining ring (C).
16. Remove outer retaining ring (B).
17. Remove spring retaining ring, spring, and inner spring retaining ring.

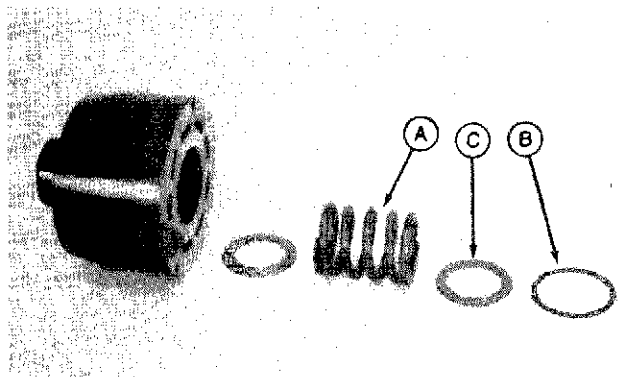

9A2;M37852 N01;5005 -JS 240987

18. Remove shaft (A) with bearing and swash plate (B) from motor housing.

19. Remove swash plate from shaft and wrap in clean paper to protect lapped surface.

20. In most cases the bearing will not need replacement. If replacement is necessary, use a press to remove it.

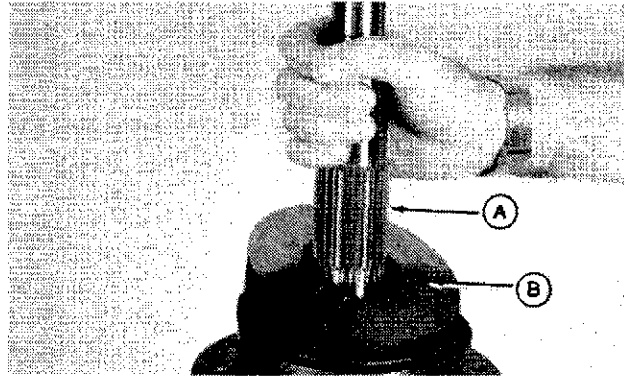

9A2;H50437 N01;5005 -JT 240987

## INSPECT PARTS

*NOTE: Some internal parts of the motor and pump are similar in appearance and function; others have the same part number. Note the various areas indicated in this illustration. Use the following illustrations to analyze failures.*

Most part failures are identifiable by inspecting the part and comparing it to the following illustrations and information to determine the suspected cause of failure.

A64; N01;5005 CM 010383

**(Worn)** This condition is usually indicated by a smooth but definite wear pattern in or across finished surfaces. A worn condition is usually caused by a lack of lubrication or very fine abrasive contamination suspended in the fluid.

**(Scored)** This condition is usually indicated by fine scratch marks in or across finished surfaces. Scoring usually is caused by a lack of or improper lubrication or possible abrasive contamination suspended in the fluid.

**(Scratched)** This condition is usually indicated by small scratches in or across finished surfaces. It is usually caused by abrasive contamination suspended in the fluid.

**(Grooved)** This condition is usually indicated by grooves cut in or across finished surfaces. Grooving is usually caused by a lack of lubrication or large particle contamination suspended in the fluid.

A64; N01;5005 CM 010383

**(Discoloration)** This condition is usually indicated by a noticeable change in color on the finished surfaces. Discoloring usually is caused by a lack of or improper lubrication.

Excessive fluid temperature may also cause this condition by increasing the lubricating film loss between rotating mating parts.

**(Smearred)** This condition is usually indicated by the presence of bronze embedded in or across finished mating surfaces. Smearing is usually caused by a lack of or improper lubrication or possible abrasive contamination suspended in the fluid. Excessive fluid temperature may also cause this condition by the lubricating fluid film loss between rotating mating parts.

A64; N01;5005 CO 170383

**(Galled)** This condition is usually indicated by the presence of material that has been removed from one surface, normally by friction, and sometimes adhered to its mating component surface. Galling usually is caused by a lack of or improper lubrication. Excessive fluid temperature may also cause this condition by increasing the lubricating fluid loss between rotating mating parts.

**(Eroded)** This condition is usually indicated by erosion (pitted appearance) or removal of material from finished surfaces. Eroding is usually caused by cavitation or voids in the fluid.

**(Rolled)** This condition is usually indicated by the extreme outer edge of the finished surface being deformed or rolled over. Rolled usually is caused by a lack of lubrication to the edges of these finished surfaces when subjected to overspeeding or block lift conditions.

A64; N01;5005 CP 170383

The following terminology will be used for determining probable causes of system and/or part failure.

*Lack of lubrication* is probably the most common, yet misinterpreted terminology associated with failure analysis of system and/or part failures. It usually is a result of condition(s) that create an insufficient oil film required to lubricate rotating part surfaces.

Without the proper oil film, rotating metal-to-metal surfaces create friction and excessive temperatures that usually cause premature part failures.

Depending on the severity of the oil film loss and friction, rotating critical surfaces will become severely worn, smeared, galled or noticeably discolored.

A64; N01;5005 CQ 010383

*Abrasive contamination* is probably the second most common, yet identifiable terminology.

This condition usually is system-related by the introduction of abrasive foreign particles that damage the critical surface areas as they pass through the system.

These abrasive particles usually are larger than the lubricating oil film thickness required to lubricate part surfaces.

A lack of lubrication may also be created by abrasive contamination that creates excessive leakage passages between critical rotating surfaces.

Depending on the size and amount of abrasive contamination passing through or contacting parts, the rotating surfaces will become worn, scored, scratched or grooved.

A64; N01;5005 CR 170383

*Cavitation* is sometimes confused with the lack of lubrication which usually is the result of, but not the cause of cavitation.

This condition usually is created by the presence of air suspended in the oil.

Excessive amounts of air in the oil will not provide an adequate film required to properly lubricate.

Partial or total restriction of the pump inlet will also create cavitation.

Depending on the severity of cavitation, rotating surfaces will become eroded, scored, smeared or galled.

A64; N01;5005 CS 170383

*Excessive oil temperature* is sometimes the result of lack of lubrication, but not necessarily the direct cause. This condition usually is system-created by improper system cooling, high pressure oil passing over relief valves and excessive closed loop leakage. Excessive oil temperatures usually will decrease the fluid viscosity or lubrication oil film thickness required to lubricate rotating surfaces.

Depending on the condition or severity of oil temperature, rotating surfaces usually will become scored, smeared, galled or discolored.

A64; N01;5005 CT 010383

The most common cause of improper lubrication is created by *chemical contaminants* present in the hydraulic fluid such as water. Water not only creates improper lubrication to rotating surfaces, but also creates undesirable chemical changes to the oil and mating surfaces.

Depending on the severity of the improper lubrication used, component parts usually will become discolored, scored, smeared, or galled.

A64; N01;5005 CU 170383

*Overspeeding* is sometimes associated with lack of lubrication, which usually is the result of, but not necessarily the direct cause of overspeeding.

Hydrostatic transmissions by design, are subject to operate within certain speed limitations. When units are operated above their design limitations, certain parts separate or tip, creating excessive loading to small areas of these parts.

This small area usually is located on the outer edge of rotating parts, and because of the excessive loading subject to this area, the lubrication is removed also. Depending on the severity of overspeeding that creates this excessive loading and loss of lubrication to rotating parts, a rolled, scored, smeared or galled condition will occur.

A64; N01;5005 CV 170383

## INSPECT SHAFT SEAL

The shaft seal assembly is a pressure-type mechanical seal that consists of two mating parts, a bronze rotating half and a steel stationary half.

To properly seal the shaft, the fire lapped sealing surface located on each seal half must be smooth, flat, and free of all nicks, burrs, and scratches.

The scoring across the sealing surface indicates the seal was subject to abrasive contamination.

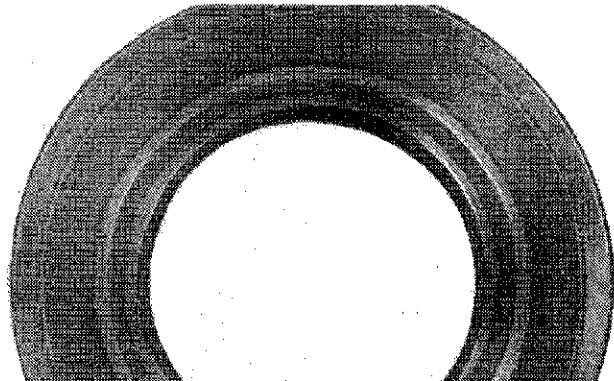

A64;N36987 N01;5005 CW 010383

The scoring marks across the sealing surface indicate that it was subject to abrasive contamination.

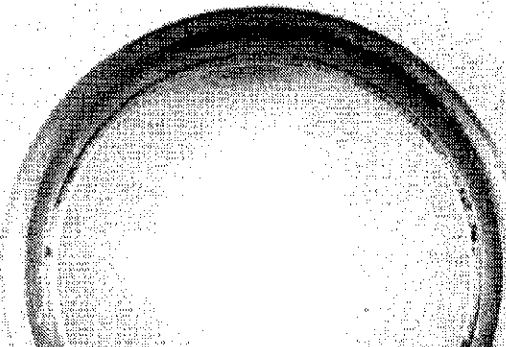

A64;H50349 N01;5005 CX 010383

The smearing around the center of the sealing surface indicates it was subject to a lack of/or insufficient lubrication. This condition usually is a result of insufficient oil film to properly lubricate rotating part mating surfaces.

The discoloration on this bronze seal half indicates the possibility of excessive oil temperatures.

Water not only creates an improper lubrication condition, but will also cause undesirable chemical changes to the oil. This chemical change to the oil usually will cause the bronze parts to discolor or turn dark.

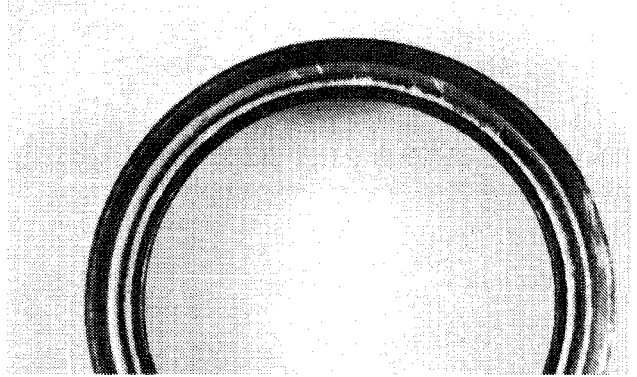

A64;H50350 N01;5005 CY 010383

### INSPECT THRUST PLATE

The smearing on this thrust plate surface indicates it was subjected to a lack of/or insufficient lubrication. This condition usually is a result of insufficient oil film required to properly lubricate rotating part surfaces.

This thrust plate may be reused by installing it with the smeared side toward the swashplate, only if the thrust plate is not damaged in any way. The other finished side must be smooth, flat and free of any nicks, burrs and scratches.



A64;H50351 N01;5005 CZ 010383

The scoring marks on this thrust plate indicate it was subjected to abrasive contamination. This contamination may have been suspended in the oil.

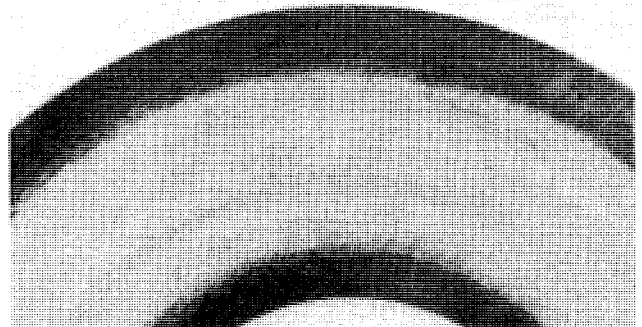

A64;H50352 N01;5005 DA 170383



**Suggest:**

**If the above button click is invalid.**

**Please download this document**

**first, and then click the above link**

**to download the complete manual.**

**Thank you so much for reading**

The discoloration on this thrust plate indicates it was subjected to extremely high temperature. This condition is a result of very high oil temperature.

This thrust plate should not be reversed and reused because the excessive temperature created bends.

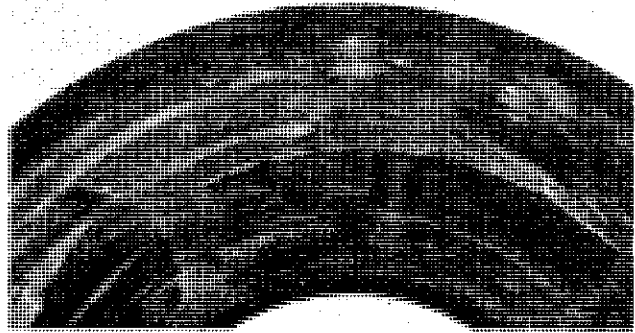

A64;H50353 N01;5005 DB 170383

### INSPECT FIXED SWASHPLATE

The scoring on this fixed swashplate indicates it was subjected to abrasive contamination.

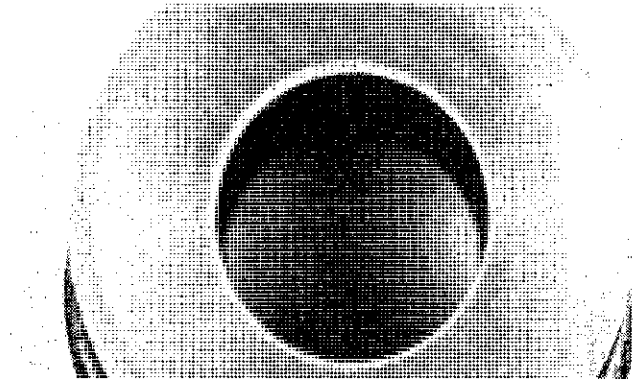

A64;H50354 N01;5005 DC 010383

### INSPECT PISTON SLIPPER

The small scratch marks across this slipper face indicates that it was subjected to some very fine abrasive.

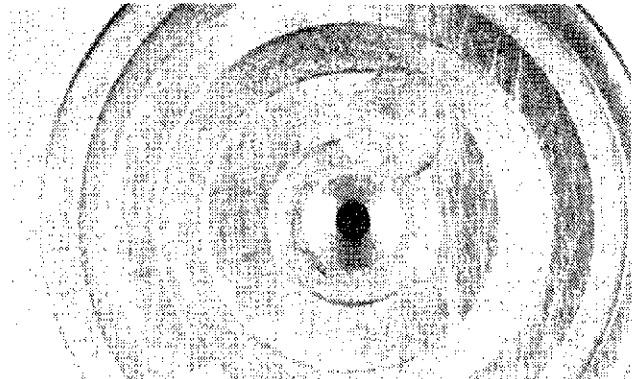

A64;H50355 N01;5005 DD 170383

The scoring on this piston slipper face indicates it was subjected to abrasive contamination. A small particle of contamination is embedded into the balance land of this piston slipper.

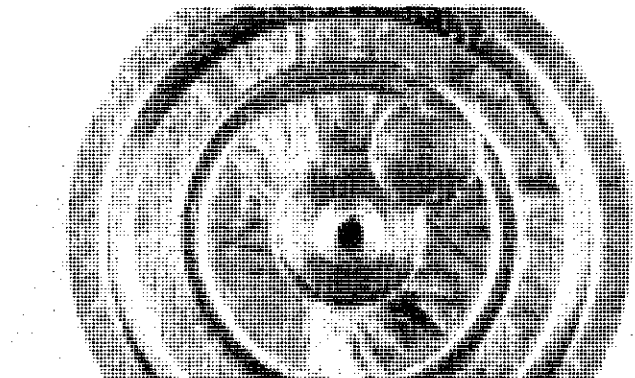

A64;H50356 N01;5005 DE 010383

**<https://www.ebooklibonline.com>**

Hello dear friend!

Thank you very much for reading.

Enter the link into your browser.

The full manual is available for immediate download.

**<https://www.ebooklibonline.com>**