



9000 Series Grain Drills



JOHN DEERE

TECHNICAL MANUAL

9000 Series
Grain Drills

TM1174 (01FEB79) English

John Deere Des Moines Works
TM1174 (01FEB79)

LITHO IN U.S.A
ENGLISH



9000 SERIES GRAIN DRILLS Technical Manual TM-1174 (Feb-79)

CONTENTS

INTRODUCTION.....	2	FERTILIZER FEED SHAFT BEARING REPLACEMENT.....	22-23
SAFETY AND YOU.....	3	FERTILIZER GEAR CASE.....	24-28
GENERAL INFORMATION.....	4-5	TRACTION-FEED FERTILIZER WHEELS AND BEARINGS.....	29-30
DIAGNOSING MALFUNCTIONS AND TESTING.....	6-8	FEED CUPS.....	31-32
PRESS WHEELS.....	8-10	DOUBLE-DISK OPENERS.....	33
CASTER WHEEL.....	11-12	GRAIN AGITATOR BEARINGS.....	34
DRIVE SHAFT AND THROW-OUT CLUTCH.....	13-16	MECHANICAL POWER LIFT.....	35-36
COUNTERSHAFT.....	17-19	GRASS SEED ATTACHMENT.....	37
FEED SHAFT BEARING REPLACEMENT.....	20-21	SPECIFICATIONS.....	38-39
REMOVING FLUTED FEED SHIFTER.....	21		

Right-hand (R.H.) and Left-hand (L.H.) Determination

"Right-hand" (R.H.) and "left-hand" (L.H.) sides are determined by facing the direction the drill will travel when in use.

All information, illustrations and specifications contained in this technical manual are based on the latest information available at the time of publication. The right is reserved to make changes at any time without notice.

INTRODUCTION

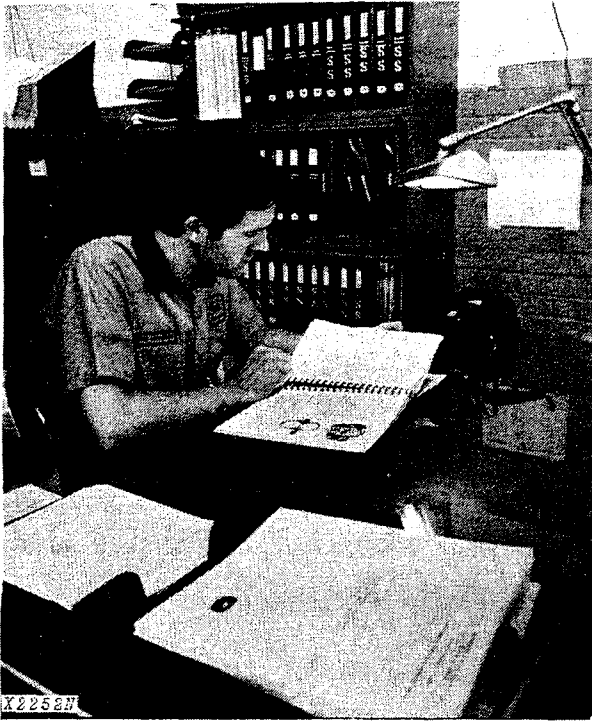

Use FOS Manuals for Reference

This technical manual is part of a twin concept of service:

- **FOS Manuals – for reference**
- **Technical Manuals – for actual service**

The two kinds of manuals work as a team to give you both the general background and technical details of shop service.

Fundamentals of Service (FOS) Manuals cover basic theory of operation, *fundamentals* of trouble shooting, *general* maintenance, and *basic* types of failures and their causes. FOS Manuals are for training new people and for reference by experienced technicians.

Technical Manuals are concise service guides for a *specific* machine. Technical Manuals are on-the-job guides containing only the vital information needed by an experienced technician.

NOTE: When the service technician may need to refer to a FOS Manual for additional information, a specific manual, chapter and/or page number is given.

Litho in U.S.A.



Use Technical Manuals for Actual Service

Some features of this technical manual.

- *Table of contents at front of manual*
- *Exploded views showing parts relationship*
- *Photos showing service techniques*
- *Specifications grouped for easy reference*

This technical manual was planned and written for you – an experienced technician. Keep it in a permanent binder in the shop where it is handy. Refer to it whenever in doubt about correct service procedures or specifications.

! This safety alert symbol identifies important safety messages in this manual. When you see this symbol, be alert to the possibility of personal injury and carefully read the message that follows.

Because John Deere sells its products worldwide, U.S. units of measure are shown with their respective Metric equivalents throughout this technical manual. These equivalents are the SI (International System) Units of Measure.

FOR YOUR CONVENIENCE

Vertical lines appear in the margins of many of the pages. These lines identify new material and revised information that affects specifications, procedures, and other important instructions.

<https://www.ebooklibonline.com>

Hello dear friend!

Thank you very much for reading.

Enter the link into your browser.

The full manual is available for immediate download.

<https://www.ebooklibonline.com>

SAFETY AND YOU



T27999N

INTRODUCTION

 This safety alert symbol identifies important safety messages in this manual and on the drill. When you see this symbol, be alert to the possibility of personal injury and carefully read the message that follows.

Be prepared if an accident or fire should occur. Know where the first aid kit and the fire extinguishers are located — know how to use them.

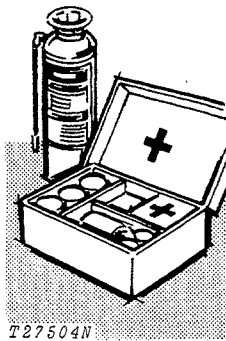

T27504N

PERSONAL SAFETY

If attached to tractor, shut off tractor engine and remove switch key before working on grain drill.

Avoid working on equipment with the tractor engine running. If it is necessary to make checks with the engine running, **ALWAYS USE TWO PEOPLE** — one, the operator, at the controls, the other person checking so as to be visible to the operator on the tractor seat. **KEEP HANDS AWAY FROM MOVING PARTS.**

Don't attempt to check belt tension while the tractor engine is running.

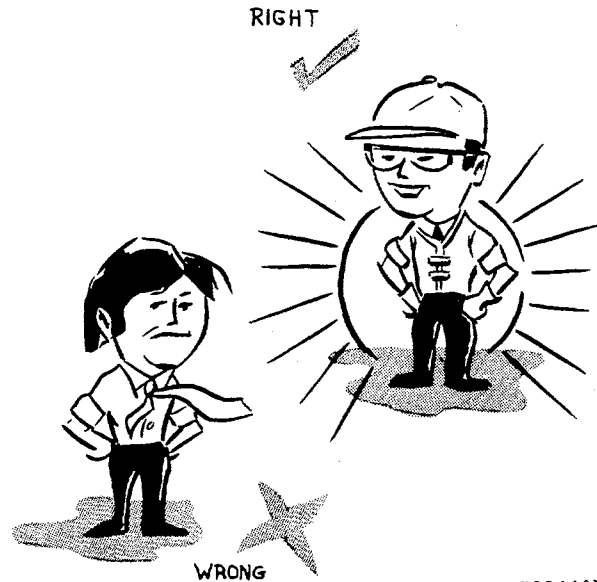

H23440N

Always avoid loose clothing or any accessory — flopping cuffs, dangling neckties and scarves — that can catch in moving parts and put you out of work.

Always wear your safety glasses while on the job.

FLUIDS UNDER PRESSURE

Escaping fluid under pressure can have sufficient force to penetrate the skin, causing serious personal injury. Before disconnecting lines, be sure to relieve all pressure. Before applying pressure to the system, be sure all connections are tight and lines, pipes and hoses are not damaged.

Fluid escaping from a very small hole can be almost invisible. Use a piece of cardboard or wood, rather than hands, to search for suspected leaks.

If injured by escaping fluid, see a doctor at once. Serious infection or reaction can develop if proper medical treatment is not administered immediately.

GENERAL INFORMATION

DESCRIPTION

The 9000 Series Press Wheel Grain Drills include two types of drills. The 9300 Series Drills are grain drills and the 9350 Series Drills are grain **and** fertilizer drills.

There are six kinds of press wheels.

There are two drill widths, 8 or 10-foot (2 438 or 3 048 mm).

There are two types of openers, disk or hoe.

There are two opener spacings available on the disk drills and four opener spacings available on the hoe drills.

Fluted feed cups meter the grain and Traction-Feed fertilizer wheels dispense the fertilizer.

The attachments available for all 9000 Series Drills include a grain agitator, grass seeder, outside scrapers for disk openers, mechanical or hydraulic row markers, rock guard attachment, acremeter, mechanical power lift and hitches for two, three, and four drills.

The serial number is located on the left-hand side of the front of the drill.

LUBRICATION

System	Capacity	Type of Lubricant
Fertilizer Feed Shaft Bearings	John Deere Multi-purpose Lubricant or an equivalent SAE multipurpose-type grease
Drive Shaft and Clutch	John Deere Multi-purpose Lubricant or an equivalent SAE multipurpose-type grease
Mechanical Power Lift	John Deere Multi-purpose Lubricant or an equivalent SAE multipurpose-type grease
Caster Wheel Spindle	John Deere Multi-purpose Lubricant or an equivalent SAE multipurpose-type grease
Gear Case	(1 qt.) (0.95 L)	John Deere SAE 90 Gear Lubricant or an equivalent SCL multi-purpose gear oil

DRIVE TRAIN DIAGRAM

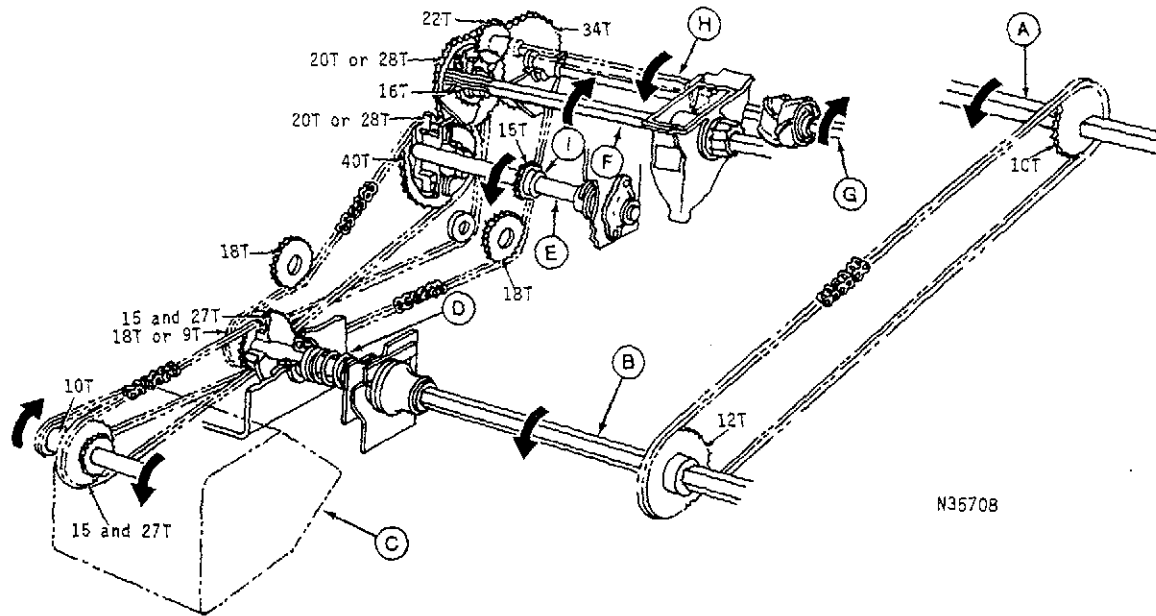

A - Press Wheel Axle
B - Primary Tube
C - Fertilizer Gear Case

D - Primary Shaft
E - Counter Shaft
F - Grain Feedshaft

G - Fertilizer Feedshaft
H - Agitator Shaft
I - Grass Drive Sprocket

T - Teeth

Fig. A - Drive Train Diagram (Disk Drill with Fertilizer)

DIAGNOSING MALFUNCTIONS AND TESTING

ORGANIZING THE DIAGNOSIS

1. Know the Unit

Study this manual to know how the individual components work and their function in the overall system.

Keep up with the latest service information. Read it and store it in a handy reference file.

2. Consult the Operator

Ask the operator how the unit was performing when the problem occurred. Find out if any corrective measures were already taken. Ask if the unit was serviced regularly as prescribed in the operator's manual.

3. Operate the Unit

If the unit can be safely operated, see for yourself how it malfunctions — don't completely rely on the operator's diagnosis.

4. Inspect the Unit

Visually check the unit. Look at the components for any cracked welds, loose hardware, damaged linkages, worn or broken lines, or anything that looks out of the ordinary.

5. List the Probable Causes

Write down the information you have learned by steps 1 through 4. What are the signs you found while inspecting the unit and what are the most probable causes as outlined under "Diagnosing"?

6. Reach Some Conclusions

Look over the possible causes and decide which ones are most likely. Reach your decision on the most probable cause and plan to check it first.

7. Test Your Conclusion

Before disassembling any components, test your conclusions to see which are correct. Tests narrow the possibilities and soon the actual cause will be pinpointed.

DIAGNOSING

Opener Disks Not Revolving

Scrapers adjusted too tightly.

Loosen, see Operator's Manual.

Pressure rod not adjusted properly.

Make sure pressure rod collar is (38 mm) 1-1/2 inches above pressure arm swivel.

Disk bearing frozen.

Replace disk and/or bearing, page 33.

Double disk assembled wrong.

Add spacer(s) between bearing and boot, page 33.

Fluted-Feed Shifter Lever Difficult to Shift

Feed gate position too high.

Lower feed gate, position shifter lever in place; then place feed gate in desired position.

Cup not cleaned after last usage.

Lubricate with penetrating oil and work loose.

Fluted-Feed Shifter Does Not Stay in Position

Bent or damaged shifter lever.

Replace entire assembly, page 21.

Varying Quantities Drilled by Individual Feeds

Feed gates not all set the same.

Set all gates identically.

Feed cup out of adjustment with the fluted-feed roll, page 32.

Set the shifter on zero and move any cups that are not completely closed, page 32.

Quantities Drilled Not Agreeing With Feed Chart

Feed gates adjusted improperly.

Adjust gates, see operator's manual.

Heavier or lighter-than-average weight seed.

Check quantity drilled, see operator's manual.

Excessive overlapping or double planting.

Be aware of driving patterns (for various field conditions) that would make the feed chart appear incorrect.

Wheel slippage because of excessive down pressure.

Use less pressure on openers.

Bridging of seed in box.

Install agitator.

Seed Distribution Stops

- Broken chain.
Replace and check drive shaft for ease of rotation.
- Feed shaft bearing worn.
Replace, page 20.
- Clutch spring broken.
Replace, page 14.
- Clutch jaws or halves are assembled wrong.
Assemble correctly, page 14.

Bunching and Skipping of Drilled Seed

- Drill improperly hitched.
Hitch drill properly, see operator's manual.
- Improper adjustment of furrow openers.
Adjust openers properly, page 33.
- Openers not turning.
Loosen scrapers or add spacers, page 33.
- Bridging of seed in box.
Install agitator.
- Loose or swinging drawbar on tractor.
Lock tractor drawbar.
- Improper adjustment of furrow openers resulting in openers not penetrating low spots or bouncing over rough ground.
Adjust furrow openers.
- Stopping drill with openers in the ground.
Raise openers before stopping.

Fertilizer Distribution Erratic or Incorrect

- Using wrong fertilizer drive.
Check for proper gear and sprocket combination, see operator's manual.
- Check quantity drilled.
See operator's manual.
- Fertilizer density other than (1 040 kg/m³) 65 lbs./ft.³.
Adjust rate for correct density, see operator's manual.
Use new density meter.
- Baffle housing bent or open too wide.
Straighten to match feed wheels or replace, page 29.
- Baffle too far from end of box.
Shift baffle and wheels closer to end of box, page 29, baffle should be no more than (3 mm) 1/8-inch from the end of box.

Fertilizer Distribution Stops

- Broken shear pin (cotter pin) on drive sprocket.
Replace pin. Check for ease of shaft rotation.
- Broken drive chains.
Inspect and replace chain; check all torques, page 38.
- Crown gear in gear case not touching pinion gears.
Add shim to adjusting shaft, page 28.
- Sleeve on feed shaft worn or rounded; shaft also rounded.
Replace, page 22.

Seed Tube Pulling Out of Disk Openers

- Tube assembled improperly.
Make sure first convolution is entirely inside boot and expanded out. Turn tube to eliminate any folds in first convolution.
Check for correct installation by pulling up on tube; then correct to feed cup.

Acremeter Tallying Incorrectly

- Land is not assumed size.
Remeasure land.
- Wheel slippage because of excessive down pressure.
Reduce pressure on openers.
- Excessive overlapping or double planting.
Be aware of driving patterns (for various field conditions) that would make the acremeter read higher.

Clutch Slips or Will Not Engage

- Improperly adjusted.
Adjust, page 16.
- Worn spring.
Replace, page 14.
- Teeth worn on clutch.
Replace, page 14.
- Throw-out rod or stationary bracket in wrong hole.
Correct, page 16.
- Broken or bent throw-out rod.
Replace rod and check correct installation, page 16.
Make sure the arm on the pressure shaft (that the rod is connected to) is installed so the flange is pointing toward the end of the drill.

Caster Wheel Pivots Excessively

Caster wheel brake out of adjustment.
Adjust hex and jam nuts, page 12.

Clutch Will Not Disengage

Worn or bent cams.
Replace, page 15 or 16.

Clutch Will Not Disengage (Continued)

Broken throw-out rod.
Replace, page 15 or 16.
Broken stationary bracket.
Replace, page 15 or 16.
Throw-out rod in wrong hole, or stationary cam
bracket out of adjustment.
Correct, page 15 or 16.

PRESS WHEELS

GENERAL INFORMATION

The press wheels provide power to turn the drive and feed shaft (s), press the seed in the furrow; and when equipped with mechanical power lift, to pull the openers out of the ground.

All wheels must be able to turn freely so a continuous and even flow of power is transmitted to the drive chain, and to prevent dirt and trash build-up on the wheels. The wheels should be checked frequently for rotation and to make sure they are not loose on the axle.

Inflate pneumatic tire to (83 kPa) 12 psi.

WHEELS, AXLE OR BEARING REPLACEMENT

If equipped with rock guard attachment, remove it as the first step when replacing bearings.

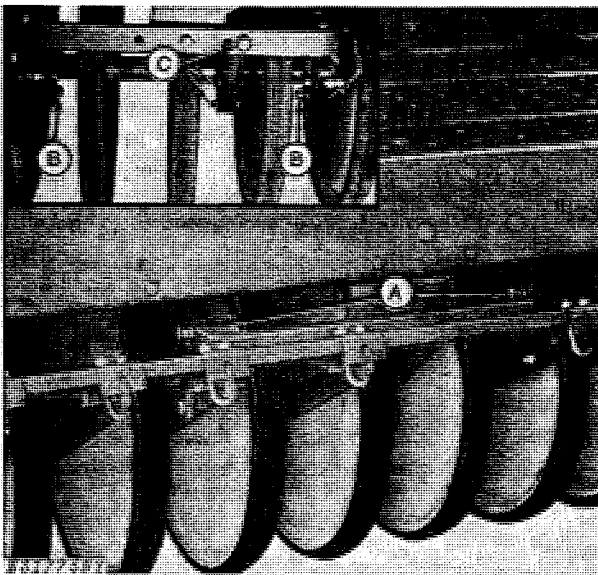

A - Rock Guard Upper Attaching Bolts
B - Rock Guard Lower Attaching Bolts
C - Chain Shield Attaching Bolts

Fig. 1 - Removing Rock Guard

1. Remove the two upper (A, Fig. 1) and two lower (B) attaching bolts (per gang) and take off the attachment. The lower bolts go through the bearing retainer.

(Right-hand Gang ONLY), Disconnect the drive chain as follows:

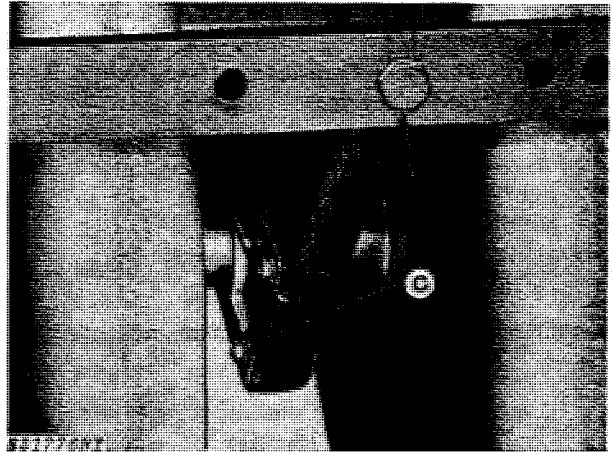

C - Chain Shield Attaching Bolts

Fig. 2 - Disconnecting Drive Chain

1. Remove the three bolts (C, Fig. 2) securing the shield to the wheels and frame.

2. Raise the wheels of the right-hand gang off the floor (with a jack under the right-hand end of the frame) and manually turn them until the chain connecting link is accessible at the front of the drill. Remove the tension from the chain by wiring the chain tightener sprocket out of the way, then disconnect the chain.

3. Lower the jack to set the wheels back on the ground.

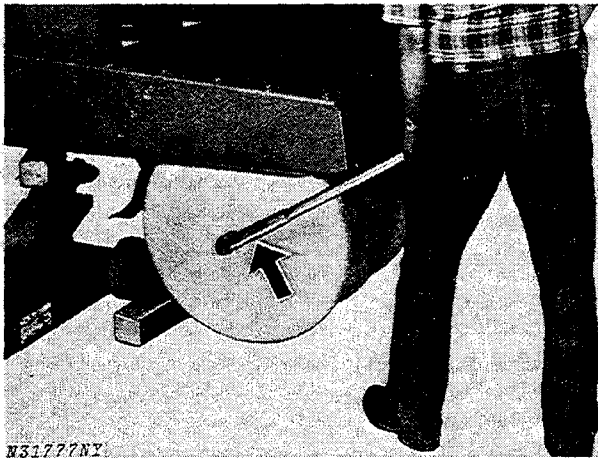

Fig. 3 - Removing Nut

2. Place a block in front of the wheels and remove the stover lock nut on the axle with a 1-1/2-inch socket wrench.

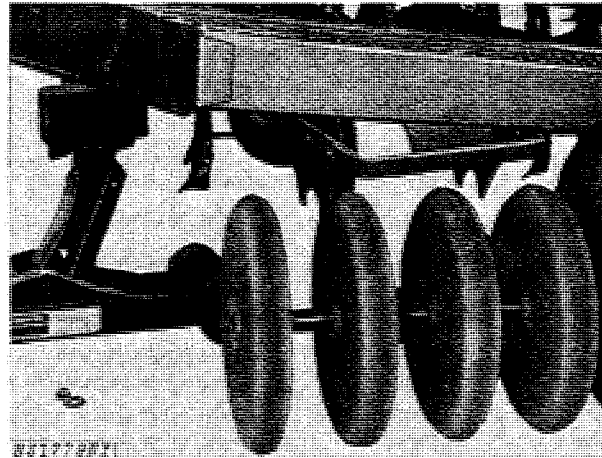
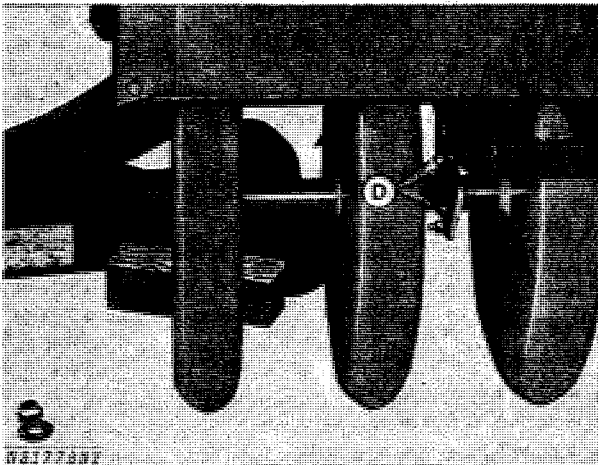

Fig. 5 - Rolling Out Gang

4. Raise the side of the drill with a jack and roll out gang of wheels from the drill.



D - Bearing Retainer Bolts

Fig. 4 - Removing Bolts

3. Remove the three bearing retainer bolts (D, Fig. 4) per bearing with a 3/4-inch wrench. When removing the bearing retainers, observe which side of the bearing carrier the halves of the bearing retainer are mounted for proper reassembly.

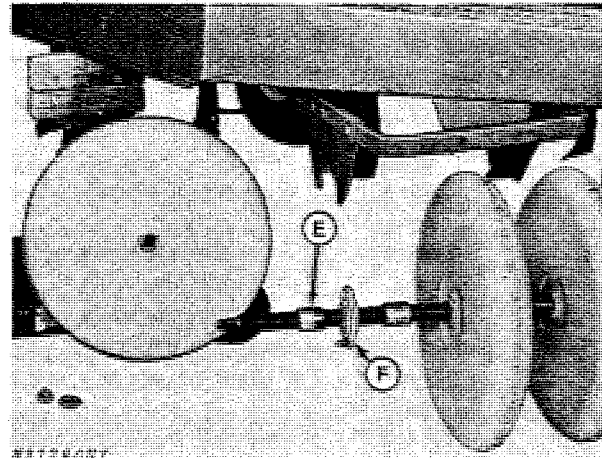

E - Spacer

F - Bearing

Fig. 6 - Sliding Wheels Off Axle

5. Slide the necessary wheels and spacers, (E, Fig. 6) off the axle to get to the bearing (F).

IMPORTANT: Keep the spacers in the same order as they were removed because of length differences. Refer to chart on page 10 to ensure correct location of spacers and other axle components.

6. Replace the bearing(s) and assemble in reverse order.

IMPORTANT: Tighten the stover lock nut to (379 N·m) 280 ft-lbs torque.

PRESS WHEEL AXLE COMPONENT LOCATIONS
8-FOOT (2 438 mm) DRILLS

No. of Openers	Opener Spacing (Inches)	Serial Number	Shaft Location	Shaft Components (See Legend Below)	Metric Equivalents		
					In.	mm	
7	14	(-8319) (8320-)	L.H.	N W 2.28 B 6.00 W 6.00 B 2.28 W N W 2.81 B 5.49 W 5.49 B 2.81 W	2	50	
			R.H.	N W 6.39 B 1.82 W 7.57 S 1.82 W 1.82 B 6.39 W N W 6.32 B 1.89 W 7.57 S 1.82 W 1.89 B 6.23 W	4	102	
		8	12	L.H.	N W 3.28 B 3.28 W 8.00 W 3.28 B 3.28 W	6	152
				R.H.	N W 3.28 B 3.28 W 3.84 S 3.84 W 3.28 B 3.28 W	7	178
10	10-2	(-8319) (8320-)	L.H.	N W 3.08 B 3.08 W 7.57 W 7.57 W 3.08 B 3.08 W N W 3.70 B 2.49 W 7.57 W 7.57 W 2.49 B 3.70 W	10	254	
			R.H.	N W 3.08 B 3.08 W 7.57 W 2.88 S 4.40 W 3.08 B 3.08 W N W 3.70 B 2.49 W 7.57 W 2.88 S 4.40 W 2.49 B 3.70 W	12	305	
		10	10-4	L.H.	N W 2.36 B 1.82 W 5.60 W 5.60 W 1.82 B 2.36 W N W 2.18 B 2.00 W 5.60 W 5.60 W 2.00 B 2.18 W	14	356
				R.H.	N W 2.36 B 1.82 W 5.60 W 1.82 S 3.44 W 1.82 B 2.36 W N W 2.18 B 2.00 W 5.60 W 1.82 S 3.44 W 2.00 B 2.18 W	0.56	14
14	7	(-8319) (8320-)	L.H.	N W 4.86 W 1.48 B 2.00 W 4.86 W 4.86 W 2.00 B 1.48 W 4.86 W	0.75	19	
			R.H.	N W 4.86 W 1.48 B 2.00 W 4.86 W 2.28 S 2.28 W 2.00 B 1.48 W 4.86 W	0.93	24	
		16	6	L.H.	N W 4.00 W 1.28 B 1.28 W 4.00 W 4.00 W 4.00 W 1.28 B 1.28 W 4.00 W	1.05	27
				R.H.	N W 4.00 W 1.28 B 1.28 W 4.00 W 1.82 S 1.82 W 4.00 W 1.28 B 1.28 W 4.00 W	1.28	33
10-FOOT (3 048 mm) DRILLS					1.48	38	
9	14	(-8319) (8320-)	L.H.	N W 5.60 B 2.28 W 9.33 W 2.28 B 5.60 W N W 5.83 B 2.08 W 9.33 W 2.08 B 5.83 W	1.63	41	
			R.H.	N W 9.33 W 1.05 B 6.84 W 3.44 S 3.28 B 1.05 W 9.33 W N W 9.33 W 1.63 B 6.32 W 3.44 S 2.61 B 1.63 W 9.33 W	1.72	44	
		10	12	L.H.	N W 8.00 W 0.56 B 6.00 W 6.00 B 0.56 W 8.00 W N W 8.00 W .075 B 5.83 W 5.83 B 0.75 W 8.00 W	1.82	46
				R.H.	N W 8.00 W 0.56 B 6.00 W 1.72 S 4.00 B 0.56 W 8.00 W N W 8.00 W 0.75 B 5.83 W 1.72 S 3.84 B 0.75 W 8.00 W	1.89	48
12	10-2	(-8319) (8320-)	L.H.	N W 8.00 W 3.28 B 3.28 W 8.00 W 3.28 B 3.28 W 8.00 W N W 8.00 W 2.69 B 3.84 W 8.00 W 3.84 B 2.69 W 8.00 W	2.00	51	
			R.H.	N W 8.00 W 3.28 B 3.28 W 3.84 W 8.00 W 3.84 B 2.69 W 8.00 W N W 8.00 W 2.69 B 3.84 W 3.84 S 3.84 W 3.84 B 2.69 W 8.00 W	2.08	53	
		12	10-4	L.H.	N W 6.00 W 2.28 B 2.28 W 6.00 W 2.28 B 2.28 W 6.00 W N W 6.00 W 1.72 B 2.81 W 6.00 W 2.81 B 1.72 W 6.00 W	2.18	55
				R.H.	N W 6.00 W 2.28 B 2.28 W 2.88 S 2.88 W 2.28 B 2.28 W 6.00 W N W 6.00 W 1.72 B 2.81 W 2.88 S 2.88 W 2.81 B 1.72 W 6.00 W	2.28	58
17	7	(-8319) (8320-)	L.H.	N W 5.06 W 1.82 B 1.82 W 5.06 W 5.06 W 5.06 W 1.82 B 1.82 W 5.06 W N W 5.06 W 1.63 B 2.00 W 5.06 W 5.06 W 5.06 W 2.00 B 1.63 W 5.06 W	2.36	60	
			R.H.	N W 5.06 W 5.06 W 0.75 B 2.88 W 5.06 W 2.88 S 1.82 W 2.88 B 0.75 W 5.06 W 5.06 W N W 5.06 W 5.06 W 0.93 B 2.69 W 5.06 W 2.88 S 1.82 W 2.69 B 0.93 W 5.06 W 5.06 W	2.49	63	
		20	6	L.H.	N W 4.00 W 4.00 W 1.28 B 1.28 W 4.00 W 4.00 W 4.00 W 1.28 B 1.28 W 4.00 W 4.00 W	2.61	66
				R.H.	N W 4.00 W 4.00 W 1.28 B 1.28 W 4.00 W 1.82 S 1.82 W 4.00 W 1.28 B 1.28 W 4.00 W 4.00 W	2.69	68

N - Nut W - Wheel Number (Inches) - Spacer Length B - Bearing S - Sprocket

CASTER WHEEL BEARING REPLACEMENT

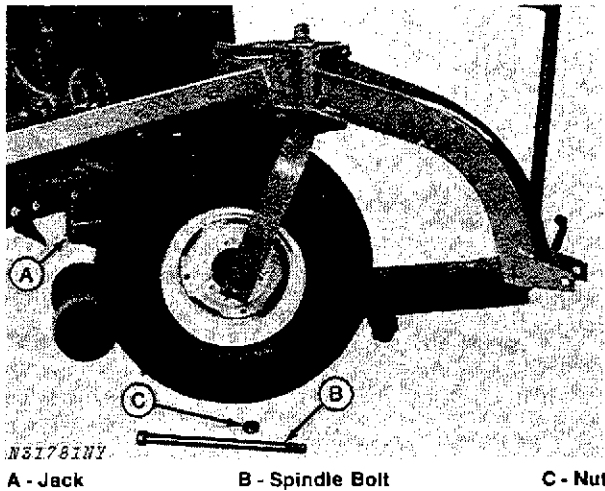

Fig. 7 - Removing Wheel and Hub

1. Raise the caster wheel off the ground with a jack placed under the front frame of the drill (A, Fig. 7).

2. Remove the spindle bolt (B) from the yoke and hub assembly by removing the nut (C) and sliding the bolt out.

NOTE: To make spindle bolt removal easier, first take the nut off, then let the tire back down on the ground to break the "seal". Jack the drill up again and remove the spindle bolt.

CAUTION: The wheel and hub assembly weights approximately (45 kg) 100 lbs. Be careful when removing it.

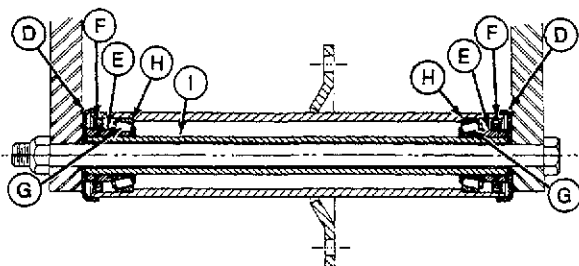

N31782N

D - End Cap F - Seal H - Bearing Cup
 E - Spacer G - Bearing Cone I - Spindle Bolt Guide

Fig. 8 - Hub Assembly

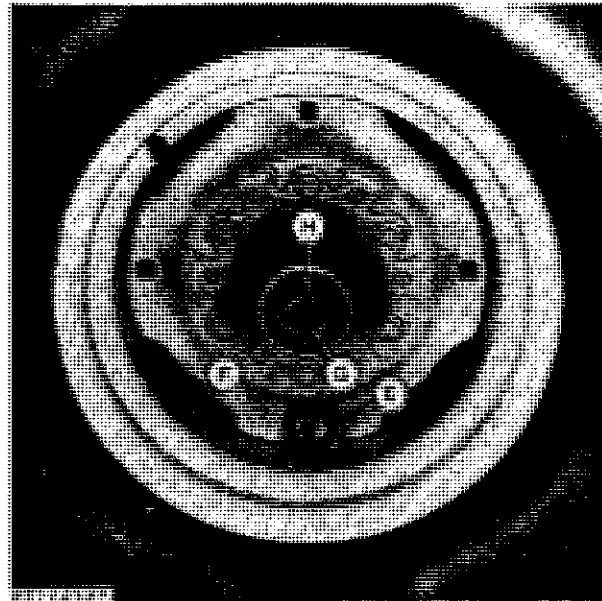

E - Spacer
 F - Seal G - Bearing Cup
 H - Spindle Bolt Guide

Fig. 9 - Spacer Out of Hub

3. After removing the spindle bolt, remove the end caps (D, Figs. 8 and 9), exposing the spacers (E) and seals (F). Remove the spacers and pry the seals out.

IMPORTANT: Always install new seals.

4. Slide the bearing cones (H) out of the hub.

5. Inspect the bearing cups (G). If necessary, drive cups out (from the inside) and replace. Use a driver with an outside diameter of (60 mm) 2-3/8-inches to install the cups (larger O.D. out).

6. Fill the hub approximately 1/3 full of wheel bearing grease. Install a new bearing that has been properly packed with grease. Fill the space in front of the bearing with grease.

7. Coat the seal with grease and install it, making sure it is seated **INSIDE** the chamfer of the housing.

8. Install the spindle bolt guide, spacer, and end cap. Assemble the wheel and hub to the yoke with the spindle bolt and install the spindle nut. Torque nut to (129-197 N•m) 95-145 ft. lbs.

NOTE: Maximum rolling torque for hub is (9 N•m) 7 ft.-lbs., maximum end play is (0.76 mm) 0.03 in.

9. Check tire inflation pressure. Inflate as necessary to (193 kPa) 28 psi.

YOKE REPLACEMENT

1. Remove the wheel and hub assembly from the yoke by removing the spindle nut and bolt. (See page 11).

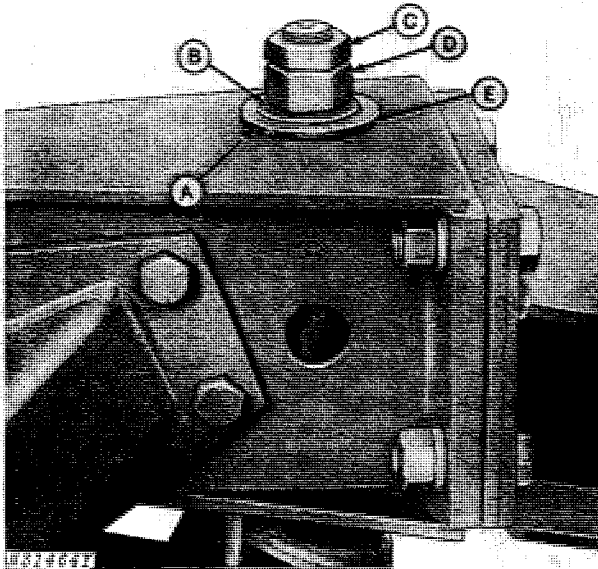

A - Flat Washer
B - Spring Washer
C - Jam Nut
D - Hex. Nut
E - Caster Wheel Support

Fig. 10 - Removing Yoke

2. Remove the jam nut (C, Fig. 10) and the hex. nut (D) from the top of the yoke; then remove the spring washer (B) and flat washer (A).

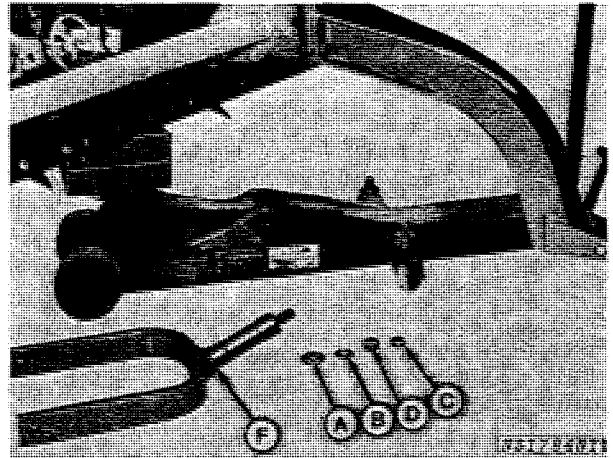

A - Flat Washer
B - Spring Washer
C - Jam Nut
D - Hex. Nut
F - Wear Washer

Fig. 11 - Yoke Removed

3. Raise the drill with a jack under the front frame and remove the yoke.

CAUTION: The yoke weighs approximately (23 kg) 50 lbs. Be careful when moving it.

4. Install the new yoke with the wear washer (F, Fig. 11). Install the flat washer, spring washer (dish face down) and hex. nut.

5. Lubricate through the grease fitting, turn the yoke 1-1/2 turns, then lubricate again.

Brake Adjustment

With drill weight on wheel, tighten hex. nut (D) until the hex. nut, spring washer (B), and the top surface of the castor wheel support (E) are just contacting. Tighten the hex. nut an additional 1/2 turn.

After the above adjustment has been made, tighten jam nut (C).

Inflate tire to (193 kPa) (1.9 bar) 28 psi.

DRIVE SHAFT AND THROW-OUT CLUTCH

GENERAL INFORMATION

The drive shaft is driven with type 2050 chain from a sprocket on the right-hand gang of press wheels. A clutch, incorporated in the drive shaft, disengages the feed shaft when the openers are raised. There are four possible sprocket locations on the inner end of the shaft to allow for different row spacings. The outer end of the shaft drives the countershaft (with the acremeter drive) with type 41 roller chain. The countershaft drives the feed shaft through gears located in the end panel of the drill.

When the drill is equipped with mechanical power lift, the inner end of the drive shaft is connected to the lift. When the lift is engaged and the drill is pulled forward, the drive shaft operates the lift, causing the openers to raise and disengaging the drive shaft clutch.

REPLACING DRIVE SHAFT INNER BEARING - 9300 and 9350

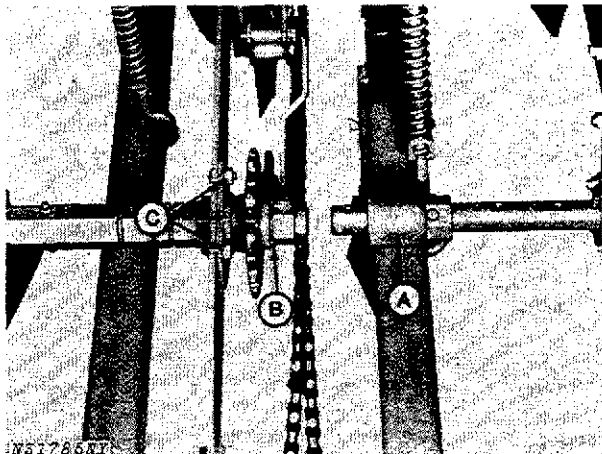

A - Power Lift Drive Socket
B - Snap Ring
C - Bearing Retainer Bolts

Fig. 12 - Removing Inner Bearing
(Drill Equipped with Power Lift)

1. Jack up right-hand side of drill to free press gang.

2. Turn the press wheels until the chain connecting link is accessible and disconnect. Wire the drive chain tightener sprocket up out of the way for ease in disconnecting. (See Step 4, page 7).

3. If equipped with power lift attachment, remove the spring pin from the power lift drive socket (A, Fig. 12) and slide the socket away from the drive shaft.

4. Depending on row spacing, remove snap ring (B) and sprocket (as illustrated).

5. Remove the three bearing retainer bolts (C).

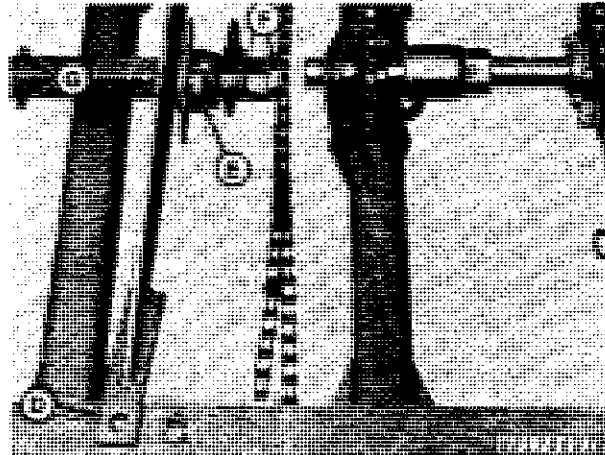

D - Bracket
E - Bearing

F - Spring Pin
G - Grease Fittings

Fig. 13 - Inner Bearing Exposed

NOTE: Keep drive shaft parts in order when removing, to ensure easier assembly.

6. If necessary, remove the 1/2-inch bolt on the front frame securing the bracket (D, Fig. 13) and slide the bracket toward the clutch to loosen the bearing (E).

7. After removing the bearing, inspect the drive shaft for wear; if worn excessively, replace the drive shaft as well as the bearing. See "Removing Drive Shaft", page 14.

8. Reassemble the inner bearing (and drive shaft if it was removed) in reverse order. Liberally lubricate the drive shaft where the bearing rides before the bearing halves are installed, and lubricate through the grease fittings after installation.

REPLACING HEX. TUBE

1. Remove the inner bearing, Figs. 12 and 13.

2. Remove the spring pin (F, Fig. 13) from the collar on the inner end of the shaft and take off the collar.

3. Remove both grease fittings (G), then slide the tube out of the clutch jaw and off the round shaft.

4. When installing a new hex. tube, liberally lubricate the round shaft. Slide the hex. shaft onto it, assemble all components, and lubricate the two grease fittings.

REMOVING DRIVE SHAFT - 9300

1. Remove the inner bearings, see page 13.

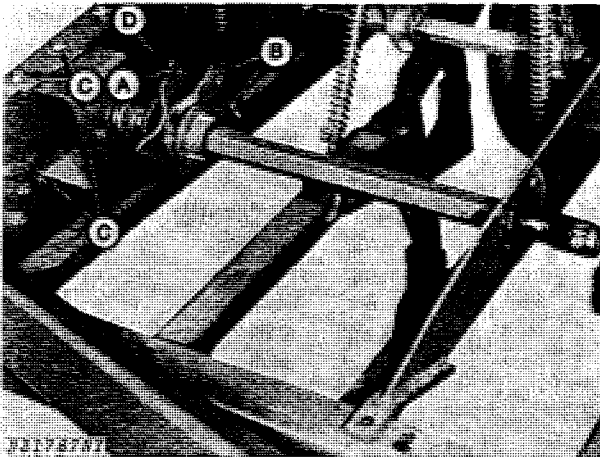

A - Outer Clutch Cam
B - Inner Clutch Cam Bracket
C - Bearing Support Bracket Bolts
D - Drive Chain

2. Remove the cotter pin and clutch throw-out rod from the outer clutch cam (A, Fig. 14), shown here removed.

3. Remove the two bolts from the inner clutch cam (B) and bracket.

4. Remove the four bolts (C) from the bearing support bracket and twist the drive sprocket out of the drive chain (D). Loosen the drive chain idler for ease in removal.

DRIVE SHAFT DISASSEMBLY - 9300

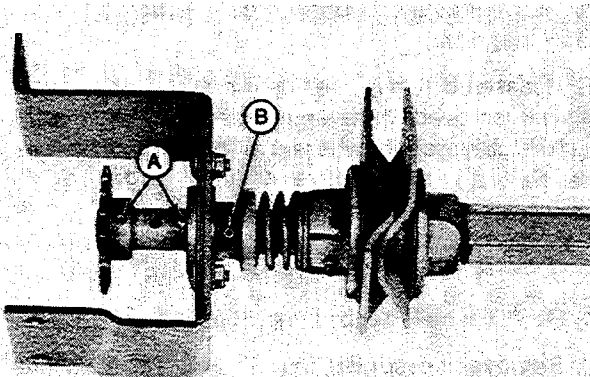

N31788NY
A - Spring Pin

B - Set Screw

Fig 15 - Drive Shaft Removed

NOTE: Keep drive shaft parts in order when removing, to ensure easier assembly.

1. Remove both spring pins (A, Fig. 15) and loosen two set screws (B). Remove sprocket and shaft.

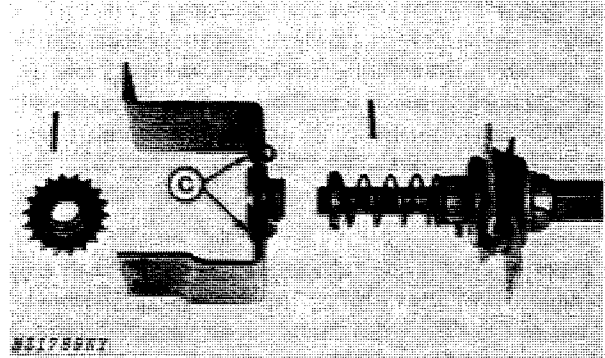

C - Bearing Retainer Bolts

Fig. 16 - Removing Bearing

2. Remove the two bearing retainer bolts (C, Fig. 16) and take off the bearing.

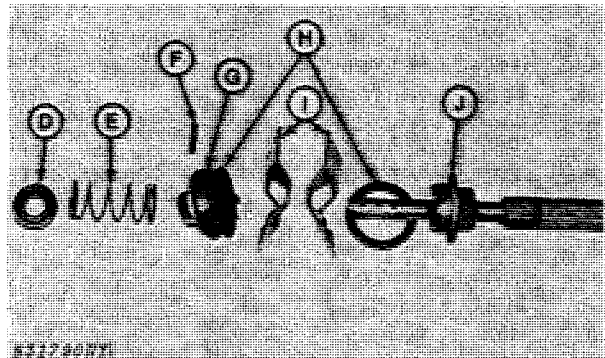

D - Spring Cup
E - Spring
F - Spring Pin
G - Outer Clutch (with grease fitting)
H - Wear Washers
I - Cams
J - Inner Clutch

Fig. 17 - Drive Shaft Components

3. Remove the cup (D, Fig. 17) and spring (E). Drive out the spring pin (F) and take off the clutch parts.

4. Slide the drive shaft out of the hex. tube for replacement.



Suggest:

If the above button click is invalid.

Please download this document

first, and then click the above link

to download the complete manual.

Thank you so much for reading

REMOVING DRIVE SHAFT - 9350

1. Remove the inner bearing, see page 13.

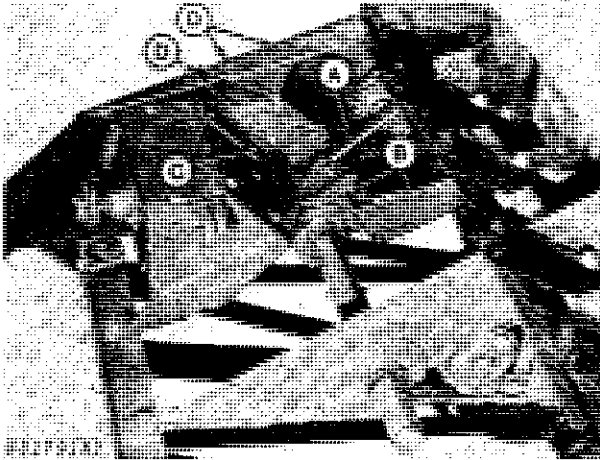

- A - Clutch-Throw-Out Rod
- B - Inner Cam Bracket Bolts
- C - Gear Case Bolts
- D - Bearing Support Bracket Bolts

Fig. 18 - Removing Drive Shaft (Disk Drill Shown)

2. Remove the cotter pin and clutch throw-out rod (A, Fig. 18) from the outer clutch cam.

3. Remove the two bolts (B) from the inner clutch cam and bracket.

4. Remove the two gear case attaching bolts (C) and the four bearing support bracket bolts (D).

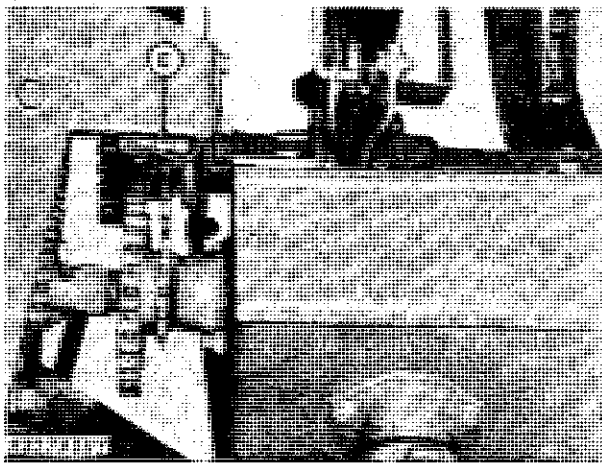

E - Drive Chain Tightener

Fig. 19 - Disconnecting Drive Chain

5. Wire the gear case drive chain tightener (E, Fig. 19) away from the chain and disconnect the chain.

6. Twist the drive shaft drive sprocket out of the countershaft drive chain and lift the drive shaft out of the drill.

DRIVE SHAFT DISASSEMBLY - 9350

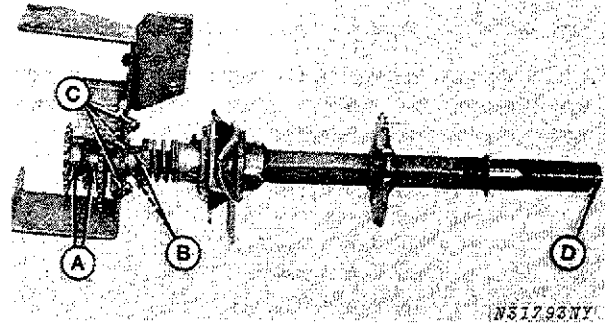

- A - Spring Pin
- B - Set Screw
- C - Bearing Retainer Bolts
- D - Spring Pin

Fig. 20 - Drive Shaft Removed

NOTE: Refer to Figs. 15 thru 17. The 9350 drive shaft components are the same as for the 9300, except for the additional double sprocket on the 9350.

1. Remove both spring pins (A, Fig. 20) and loosen both set screws (B). Slide the sprockets off the shaft.

2. Remove three bearing retainer bolts (C) to replace the bearing.

3. Remove the spring pin (D) and collar from the inner end of the shaft.

4. Slide all parts remaining on the shaft off the inner end of the shaft.

<https://www.ebooklibonline.com>

Hello dear friend!

Thank you very much for reading.

Enter the link into your browser.

The full manual is available for immediate download.

<https://www.ebooklibonline.com>