

# 8570, 8770, 8870 and 8970 Tractors Repair

For complete service information also see:

8570, 8770, 8870, and 8970 Tractors

Operation and Tests . . . . . TM1550

6076 Engine

Serial Number (500000- ) . . . . . CTM42

6101 Engine . . . . . CTM20

Radial Piston Pumps . . . . . CTM7

Engine Accessories . . . . . CTM11

1600 Series Axles . . . . . CTM18

**John Deere Waterloo Works**  
**TM1549 (10MAR93)**

LITHO IN U.S.A.  
ENGLISH

# Introduction

## FOREWORD

This manual is written for an experienced technician. Essential tools required in performing certain service work are identified in this manual and are recommended for use.

Live with safety: Read the safety messages in the introduction of this manual and the cautions presented throughout the text of the manual.



This is the safety-alert symbol. When you see this symbol on the machine or in this manual, be alert to the potential for personal injury.

Technical manuals are divided in two parts: repair and diagnostics. Repair sections tell how to repair the components. Diagnostic sections help you identify the majority of routine failures quickly.

Information is organized in groups for the various components requiring service instruction. At the beginning of each group are summary listings of all applicable essential tools, service equipment and tools, other materials needed to do the job, service parts kits, specifications, wear tolerances, and torque values.

Binders, binder labels, and tab sets can be ordered by John Deere dealers direct from the John Deere Distribution Service Center.

This manual is part of a total product support program.

## FOS MANUALS—REFERENCE

### TECHNICAL MANUALS—MACHINE SERVICE

### COMPONENT MANUALS—COMPONENT SERVICE

Fundamentals of Service (FOS) Manuals cover basic theory of operation, fundamentals of troubleshooting, general maintenance, and basic type of failures and their causes. FOS Manuals are for training new personnel and for reference by experienced technicians.

Technical Manuals are concise guides for specific machines. Technical manuals are on-the-job guides containing only the vital information needed for diagnosis, analysis, testing, and repair.

Component Technical Manuals are concise service guides for specific components. Component technical manuals are written as stand-alone manuals covering multiple machine applications.

## HANDLE FLUIDS SAFELY—AVOID FIRES

When you work around fuel, do not smoke or work near heaters or other fire hazards.

Store flammable fluids away from fire hazards. Do not incinerate or puncture pressurized containers.

Make sure machine is clean of trash, grease, and debris.

Do not store oily rags; they can ignite and burn spontaneously.



DX,FLAME -19-04JUN90

05  
1-05  
-JUN-23AUG88  
TS227

## PREVENT BATTERY EXPLOSIONS

Keep sparks, lighted matches, and open flame away from the top of battery. Battery gas can explode.

Never check battery charge by placing a metal object across the posts. Use a volt-meter or hydrometer.

Do not charge a frozen battery; it may explode. Warm battery to 16°C (60°F).



DX,SPARKS -19-03MAR93

-JUN-23AUG88  
TS204

## PREPARE FOR EMERGENCIES

Be prepared if a fire starts.

Keep a first aid kit and fire extinguisher handy.

Keep emergency numbers for doctors, ambulance service, hospital, and fire department near your telephone.

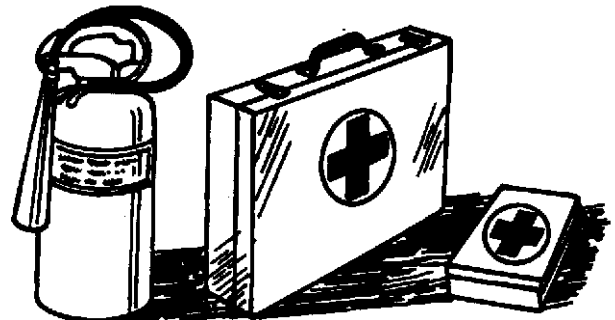

DX,FIRE2 -19-03MAR93

-JUN-23AUG88  
TS291

**<https://www.ebooklibonline.com>**

Hello dear friend!

Thank you very much for reading.

Enter the link into your browser.

The full manual is available for immediate download.

**<https://www.ebooklibonline.com>**

## PREVENT ACID BURNS

Sulfuric acid in battery electrolyte is poisonous. It is strong enough to burn skin, eat holes in clothing, and cause blindness if splashed into eyes.

Avoid the hazard by:

1. Filling batteries in a well-ventilated area.
2. Wearing eye protection and rubber gloves.
3. Avoiding breathing fumes when electrolyte is added.
4. Avoiding spilling or dripping electrolyte.
5. Use proper jump start procedure.

If you spill acid on yourself:

1. Flush your skin with water.
2. Apply baking soda or lime to help neutralize the acid.
3. Flush your eyes with water for 10—15 minutes. Get medical attention immediately.

If acid is swallowed:

1. Drink large amounts of water or milk.
2. Then drink milk of magnesia, beaten eggs, or vegetable oil.
3. Get medical attention immediately.

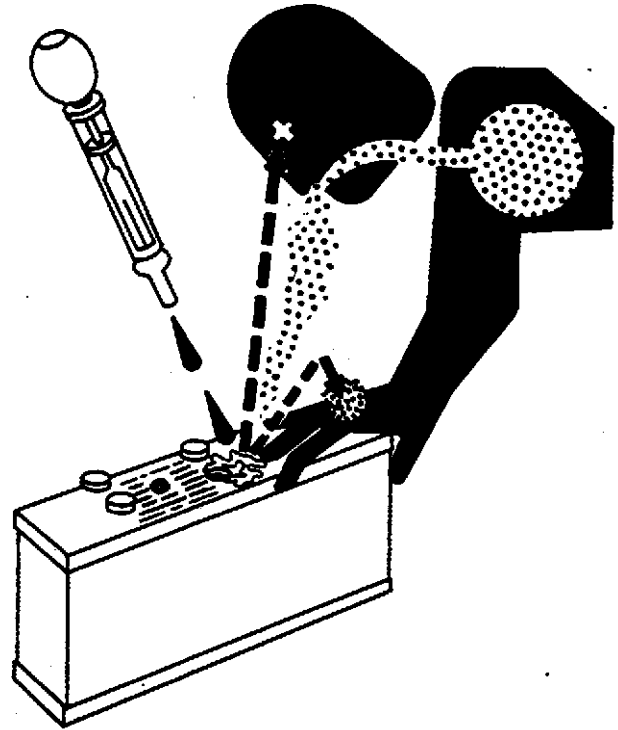

TS203 -JUN-23AUG88

DX,POISON -19-04JUN90

## HANDLE CHEMICAL PRODUCTS SAFELY

Direct exposure to hazardous chemicals can cause serious injury. Potentially hazardous chemicals used with John Deere equipment include such items as lubricants, coolants, paints, and adhesives.

A Material Safety Data Sheet (MSDS) provides specific details on chemical products: physical and health hazards, safety procedures, and emergency response techniques.

Check the MSDS before you start any job using a hazardous chemical. That way you will know exactly what the risks are and how to do the job safely. Then follow procedures and recommended equipment.

(See your John Deere dealer for MSDS's on chemical products used with John Deere equipment.)

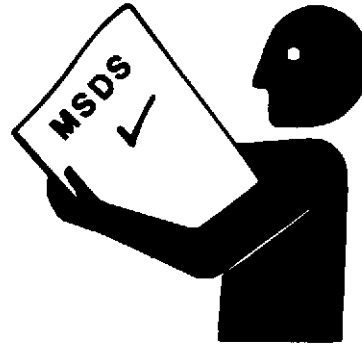

DX.MSDS,NA -19-03MAR93

05  
3  
-JUN-26NOV90  
TS1132

## AVOID HIGH-PRESSURE FLUIDS

Escaping fluid under pressure can penetrate the skin causing serious injury.

Avoid the hazard by relieving pressure before disconnecting hydraulic or other lines. Tighten all connections before applying pressure.

Search for leaks with a piece of cardboard. Protect hands and body from high pressure fluids.

If an accident occurs, see a doctor immediately. Any fluid injected into the skin must be surgically removed within a few hours or gangrene may result. Doctors unfamiliar with this type of injury should reference a knowledgeable medical source. Such information is available from Deere & Company Medical Department in Moline, Illinois, U.S.A.

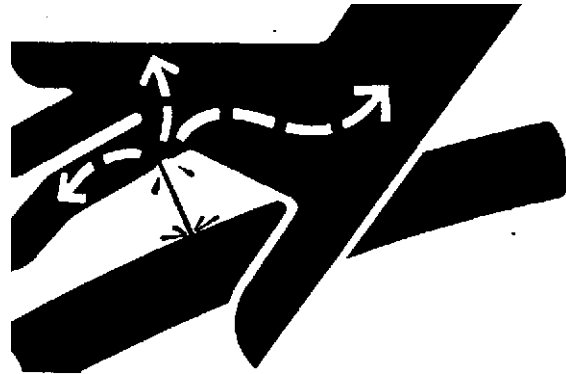

DX,FLUID -19-03MAR93

-JUN-23AUG88  
X9811

05  
05  
4

### PARK MACHINE SAFELY

Before working on the machine:

- Lower all equipment to the ground.
- Stop the engine and remove the key.
- Disconnect the battery ground strap.
- Hang a "DO NOT OPERATE" tag in operator station.

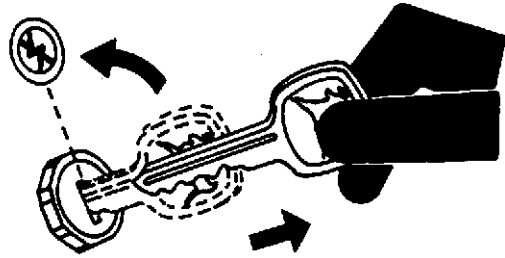

DX,PARK -19-04JUN90

TS230 -JUN-24MAY89

### SUPPORT MACHINE PROPERLY

Always lower the attachment or implement to the ground before you work on the machine. If you must work on a lifted machine or attachment, securely support the machine or attachment.

Do not support the machine on cinder blocks, hollow tiles, or props that may crumble under continuous load. Do not work under a machine that is supported solely by a jack. Follow recommended procedures in this manual.

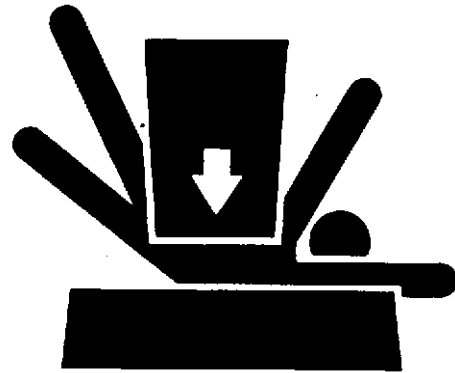

DX,LOWER -19-04JUN90

TS229 -JUN-23AUG88

### WEAR PROTECTIVE CLOTHING

Wear close fitting clothing and safety equipment appropriate to the job.

Prolonged exposure to loud noise can cause impairment or loss of hearing.

Wear a suitable hearing protective device such as earmuffs or earplugs to protect against objectionable or uncomfortable loud noises.

Operating equipment safely requires the full attention of the operator. Do not wear radio or music headphones while operating machine.

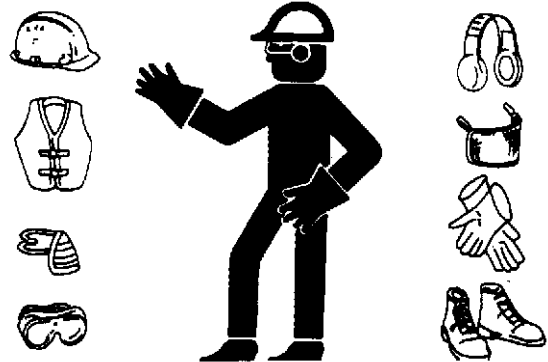

DX,WEAR -19-10SEP90

TS206 -JUN-23AUG88

## WORK IN CLEAN AREA

Before starting a job:

- Clean work area and machine.
- Make sure you have all necessary tools to do your job.
- Have the right parts on hand.
- Read all instructions thoroughly; do not attempt shortcuts.

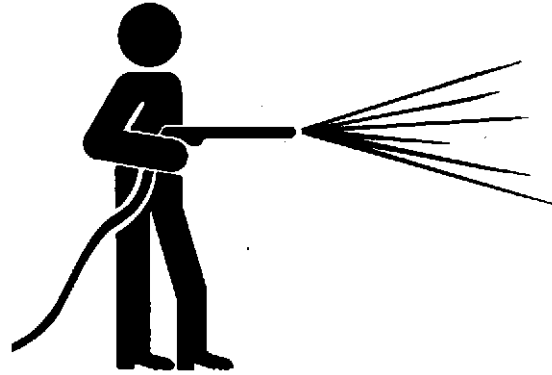

DX,CLEAN -19-04JUN90

T6642EJ -JUN-18OCT88

5195

## SERVICE MACHINES SAFELY

Tie long hair behind your head. Do not wear a necktie, scarf, loose clothing, or necklace when you work near machine tools or moving parts. If these items were to get caught, severe injury could result.

Remove rings and other jewelry to prevent electrical shorts and entanglement in moving parts.

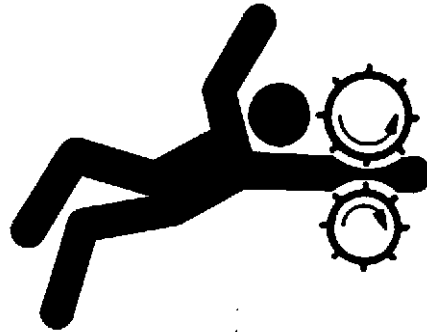

DX,LOOSE -19-04JUN90

TS228 -JUN-23AUG88

## WORK IN VENTILATED AREA

Engine exhaust fumes can cause sickness or death. If it is necessary to run an engine in an enclosed area, remove the exhaust fumes from the area with an exhaust pipe extension.

If you do not have an exhaust pipe extension, open the doors and get outside air into the area.

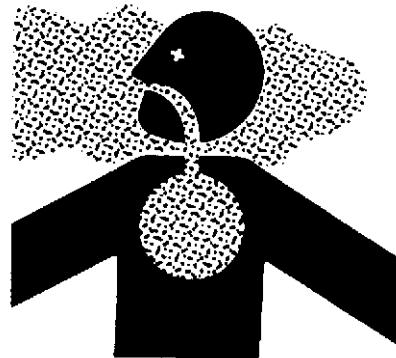

DX,AIR -19-04JUN90

TS220 -JUN-23AUG88

## ILLUMINATE WORK AREA SAFELY

Illuminate your work area adequately but safely. Use a portable safety light for working inside or under the machine. Make sure the bulb is enclosed by a wire cage. The hot filament of an accidentally broken bulb can ignite spilled fuel or oil.



DX,LIGHT -19-04JUN90

TS223 -JUN-23AUG88

## SPECIAL OR ESSENTIAL TOOLS

*NOTE: Order tools according to information given in the U.S. SERVICE-GARD™ Catalog or in the European Microfiche Tool Catalog (MTC).*

DX,TOOLS -19-05JUN91

Gudgeon Oscillation Stop . . . . . JDG660

RW18082 -UN-09APR90

Prevents gudgeon oscillation during axle removal

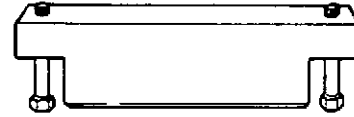

JDG660 -19-10APR90

## SERVICE EQUIPMENT AND TOOLS

*NOTE: Order tools from the U.S. SERVICEGARD™ Catalog or from the European Microfiche Tool Catalog (MTC). Some tools may be available from a local supplier.*

Name	Use
D05124ST Torque Multiplier	Remove and install axle mounting cap screws
* DFRW22 Balancer Tool	Aid in axle and final drive removal or installation

\* Dealer Fabricated Tool—See Section 99

RX14331505,1 -19-10APR90

## SPECIFICATIONS

Item	Measurement	Specification
Axle Housing to Frame Mounting Cap Screws	Torque	1070 N·m (790 lb-ft)
Drive Shaft Cap Screws	Torque	150 N·m (110 lb-ft)
Drawbar Support Stabilizer Link Cap Screws	Torque	620 N·m (460 lb-ft)
Rear Drawbar Support Cap Screws	Torque	620 N·m (460 lb-ft)

RX14331510,5B -19-31JAN92

## AXLE AND FINAL DRIVE REPAIR— USE CTM-18

For complete repair information on the 1600 Series Axles, component technical manual (CTM-18) is also required.

Use the component technical manual in conjunction with this machine manual.



RX14331505,3 -19-30JAN92

RW14298 -JUN-13DEC88

## REMOVE REAR AXLE AND FINAL DRIVES

For tractors equipped WITH hitch and PTO, perform Steps 1—6. For tractors WITHOUT hitch and PTO, begin with Step 7.

1. Remove draft links, lift links, center link, and quick coupler.
2. Disconnect electrical harness from hitch control valve.
3. Disconnect lift cylinders from lift arm. Tie lift arm securely to brace (A).

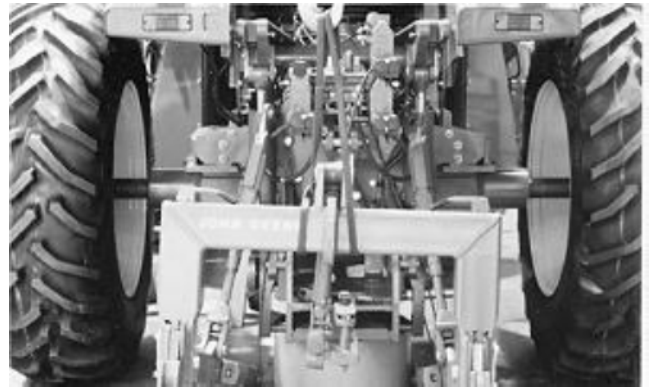

RW13422 -JUN-11JUN90

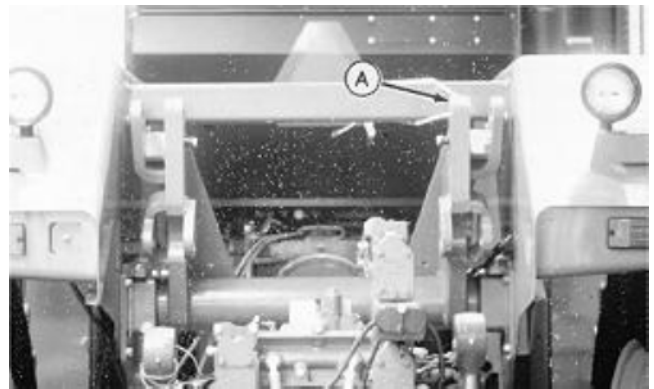

RW13388 -JUN-11JUN90

RX14331510,2 -19-31JAN92

4. Disconnect driveshaft from PTO drop box.
5. Disconnect upper inlet hose and bottom return hose from PTO drop box.
6. Remove six support bracket cap screws (A).

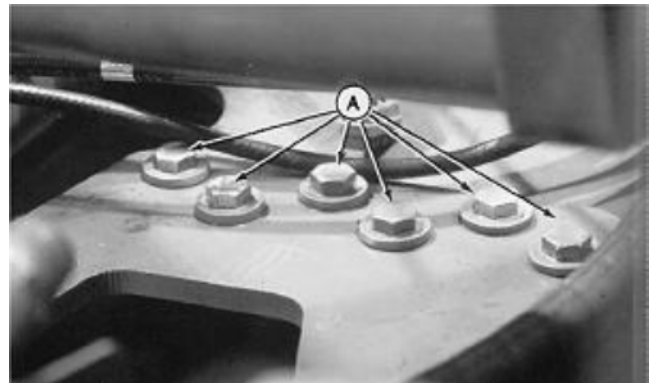

RW13387 -JUN-11JUN90

RX14331510,3 -19-10APR90

**For tractors WITHOUT hitch and PTO, or with hitch and PTO removed, perform the following steps:**

7. Drain oil from axle assembly.
  8. Disconnect SCV manifold from bracket.
  9. Remove draft sensor assembly (A), if equipped.
  10. Remove draft link supports (B) (with hitch) or drawbar support stabilizer links (without hitch).
  11. Install lifting strap around rear drawbar support, or to center link attaching pin if equipped with hitch.
  12. Remove six cap screws holding rear plate.
  13. Remove rear plate with drawbar.
- NOTE: Drop box and hitch lift cylinders can be removed with rear drawbar support, for tractors equipped with hitch and PTO.*
14. Lift rear gudgeon cover.
  15. Disconnect hoses and drive shaft to rear axle and final drives.

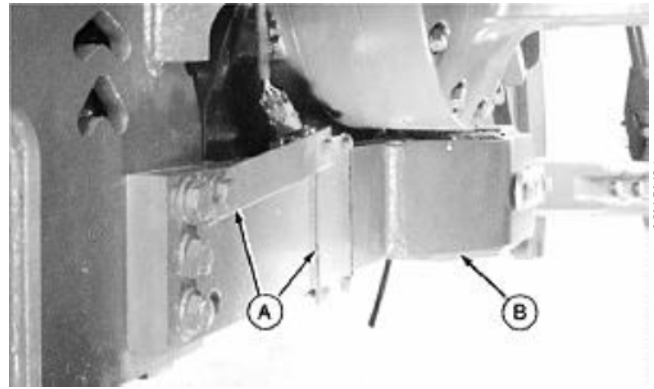

RW19560 -JUN06NOV91

15  
10  
3

RX14331510,1B -19-13DEC91

16. Install JDG660 Gudgeon Oscillation Stop (B) to keep rear frame from oscillating.
17. Install stand under gudgeon (A).
18. Remove rear wheels.

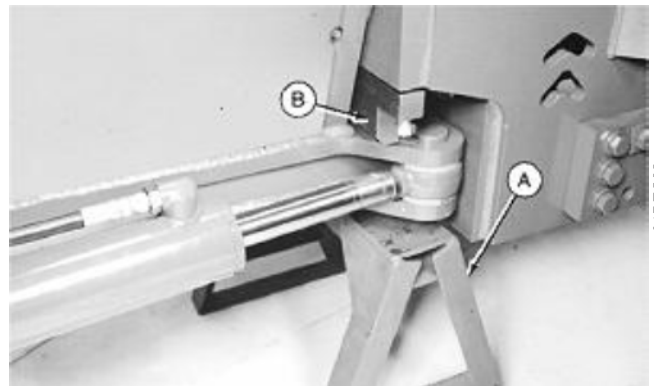

RW22271 -JUN01DEC92

RX15491510,1 -19-24FEB93

19. Remove two outer axle mounting cap screws (A).
20. Attach DFRW22 Balancer Tool (B) with two removed cap screws to balance axle. (See Dealer Fabricated Tools, Section 99.)
21. Attach hoist and lifting straps (C) to axles. Remove remaining cap screws and lower axle away from rear frame.

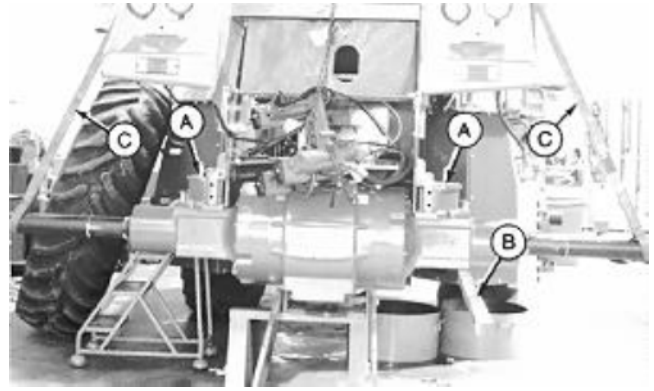

RX14331510,3B -19-13DEC91

RW18099  
-JUN-09APR90

15  
10  
4

## INSTALL REAR AXLE AND FINAL DRIVES

1. Raise axle and final drives under tractor and tighten attaching cap screws to 1070 N·m (790 lb-ft).
2. Turn axle to align drive shafts. Install four drive shaft cap screws and tighten to 150 N·m (110 lb-ft).
3. Install hoses to rear axle.
4. Install rear drawbar support. Finger tighten attaching cap screws.
5. Install drawbar support stabilizer links (draft link supports with hitch). Start all cap screws before tightening either side.
6. Tighten stabilizer links cap screws to 620 N·m (460 lb-ft).
7. Tighten rear drawbar support cap screws to 620 N·m (460 lb-ft).
8. Install hitch and PTO components in reverse order of disassembly.
9. Install rear wheels.
10. Check hydraulic oil level.
11. Recalibrate draft sensor per TM1550, Section 270, Group 10A.

RX15491510,2 -19-24FEB93

**SPECIAL OR ESSENTIAL TOOLS**

*NOTE: Order tools according to information given in the U.S. SERVICE-GARD™ Catalog or in the European Microfiche Tool Catalog (MTC).*

DX,TOOLS -19-05JUN91

Flywheel Turning Tool . . . . . JDE81-1  Turn engine flywheel	RG4950 -UN-23AUG88	
		JDE81,1A -19-21MAY91

Timing Pin . . . . . JDE81-4  Lock engine flywheel	RG5068 -UN-23AUG88	
		JDE81,4A -19-10APR90

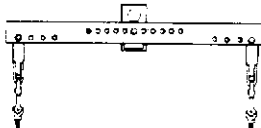
Lift Sling . . . . . JDG23  Remove and install engine	RW18149 -UN-09APR90	
		JDG23 -19-21MAY91

**SERVICE EQUIPMENT AND TOOLS**

*NOTE: Order tools from the U.S. SERVICEGARD™ Catalog or from the European Microfiche Tool Catalog (MTC). Some tools may be available from a local supplier.*

Name	Use
JDG19 Special Mounting Bracket	Remove and install components
JDG138-1 Alternator and Compressor Adapter	Adjust engine V-belts tension
JDG529 Belt Tension Gauge	Adjust engine V-belts tension

RX14331515,5B -19-09JAN92

## SPECIFICATIONS

Item	Measurement	Specification
Engine Mounting Cap Screws	Torque	366 N·m (260 lb-ft)
Engine Coupler Driveshaft	Torque	204 N·m (150 lb-ft)
Air Conditioning Compressor Adjusting Strap Cap Screw	Torque	30 N·m (22 lb-ft)
Air Conditioning Compressor Belt		
All Models		
New Belt	Tension	580—620 N (130—140 lb)
After Break In*	Tension	380—420 N (85—95 lb)

\* Break-in period is 10 minutes

RX14331515.6B -19-13DEC91

## REMOVE ENGINE

1. Drain antifreeze and disconnect battery ground cable.
2. Remove hood (A), hood support/cross brace, side panels (B), and left side hood rail (C).
3. On 8970, remove cross brace behind the radiator.



RW22282 -JUN15JAN93

RX15491515.1 -19-24FEB93

## Engine/Engine

4. Disconnect wiring harnesses at left front of engine.
5. Remove electrical power cables (A) from starter.
6. Disconnect all radiator hoses from engine.
7. Remove air-to-air after cooler pipe on 8570, 8770, and 8870.
8. Remove ether starting aid line.
9. Remove air conditioning compressor and tie to side of tractor.

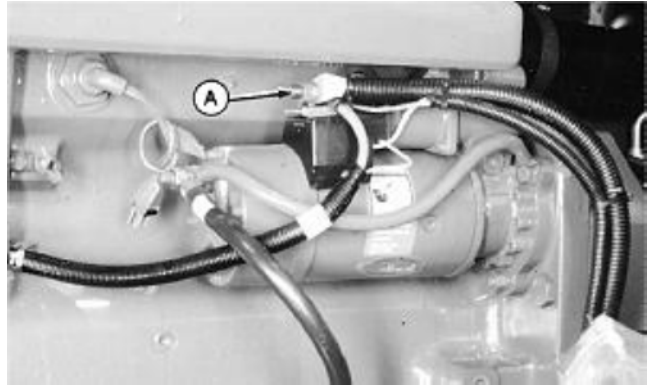

-JUN-15JAN93  
RW22283

RX15491515.2 -19-24FEB93

10. Remove viscous drive (A).
11. Remove fan (B).
12. Remove fan shroud.

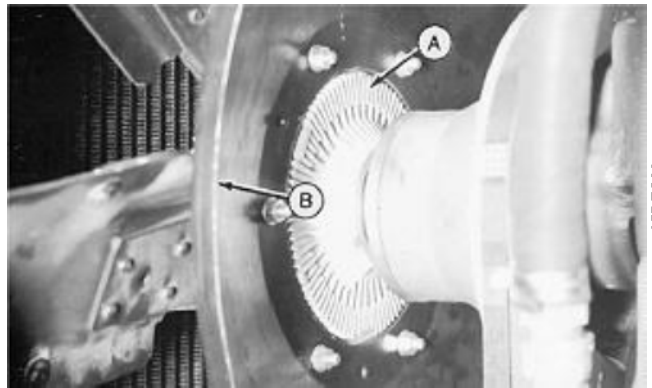

-JUN-05DEC88  
RW14009

RX15491515.3 -19-24FEB93

13. Disconnect fuel lines.
14. Disconnect throttle control wiring harness.
15. Disconnect air and exhaust pipes from turbocharger.
16. Disconnect heater hoses from engine.

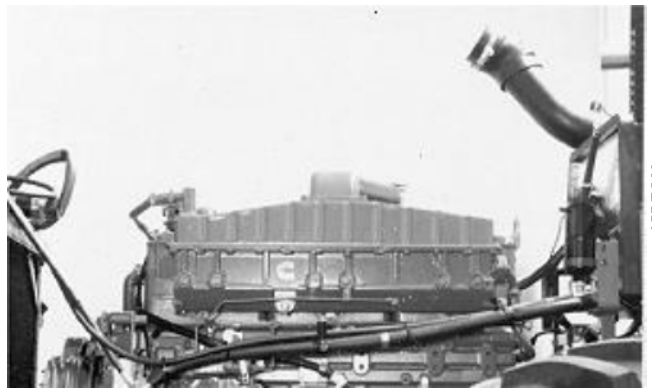

-JUN-05DEC88  
RW13447

RX15491515.4 -19-24FEB93

17. Disconnect engine-to-transmission drive shaft (A). Remove drive shaft coupler cap screws on 8570, 8770, and 8870 tractors using a JDE81-1 Flywheel Turning Tool and a JDE81-4 Timing Tool to hold flywheel from turning.

18. Remove plastic flywheel cover (B) on 8570 tractor.

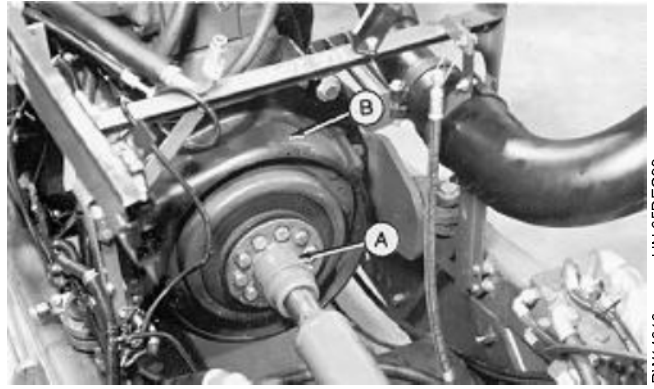

RX15491515.5 -19-24FEB93

RW14010 -JUN05DEC88

19. Install JDG23 Engine Lift Sling to engine lifting brackets or eye bolts.



8570-8770-8870

RW13452 -JUN05DEC88

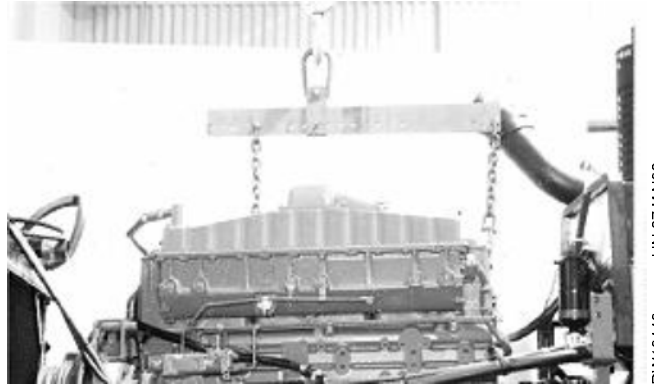

8970

RW13449 -JUN27JAN92

RX15491515.6 -19-24FEB93

15  
15  
4

20. Remove front (A) and rear (B) engine isolator mounting cap screws.

21. Carefully lift engine from tractor.

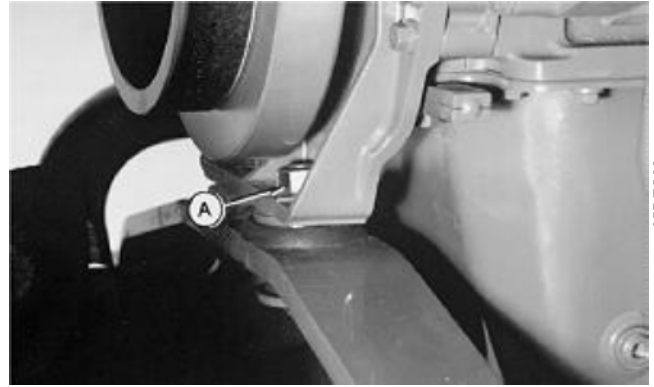

RW13450 -JUN05DEC88

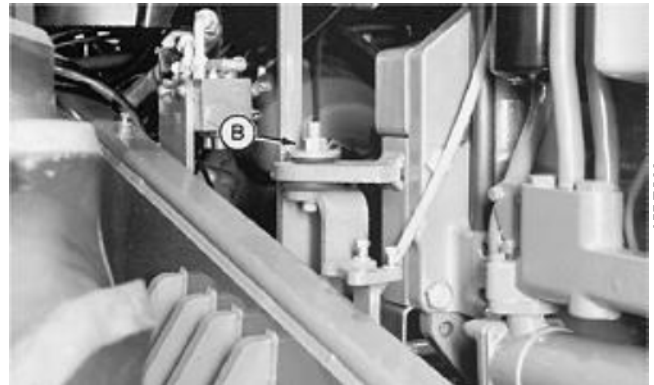

RW13451 -JUN05DEC88

RX14331515,3B -19-13DEC91

## INSTALL ENGINE

1. Install engine and tighten isolator mounting cap screws to 366 N·m (260 lb-ft).
2. Tighten drive shaft-to-engine coupler cap screws to 204 N·m (150 lb-ft).
3. Install air conditioning compressor and tighten adjusting strap cap screw to 30 N·m (22 lb-ft).
4. Tighten air conditioning compressor belt tension with a JDG529 Belt Tension Gauge (A) and a JDG138-1 Adapter. Tension should be set to the following specifications:



RG4683 -JUN15DEC88

*NOTE: Specification for air conditioning belt tension is the same for all tractor models.*

### BELT TENSION SPECIFICATION

New Belt . . . . .	580—620 N (130—140 lb force)
After Break In* . . . . .	380—420 N (85—95 lb force)

\* Break-in period is 10 minutes

RX15491515,7 -19-24FEB93

**SPECIAL OR ESSENTIAL TOOLS**

*NOTE: Order tools according to information given in the U.S. SERVICE-GARD™ Catalog or in the European Microfiche Tool Catalog (MTC).*

DX,TOOLS -19-05JUN91

Lifting Bracket . . . . . JDG15

RW18152 -UN-09APR90

Remove and install SOUND-GARD body



JDG15 -19-12OCT90

**SERVICE EQUIPMENT AND TOOLS**

*NOTE: Order tools from the U.S. SERVICEGARD™ Catalog or from the European Microfiche Tool Catalog (MTC). Some tools may be available from a local supplier.*

Name	Use
JDG19 Special Mounting Bracket	Remove and install components

RX14331520,15B -19-09JAN92

**SPECIFICATIONS**

Item	Measurement	Specification
Sound-Gard Body Mounts	Torque	204 N·m (150 lb-ft)

RX14331520,13B -19-13DEC91

15  
20  
1

## REMOVE SOUND-GARD BODY

1. Install hinge lock pin (A) to lock tractor in straight position.



RW17875  
-JUN-18DEC89

RX14331520,14B -19-30JAN92

2. Disconnect battery ground cable (A) under right rear of SGB.

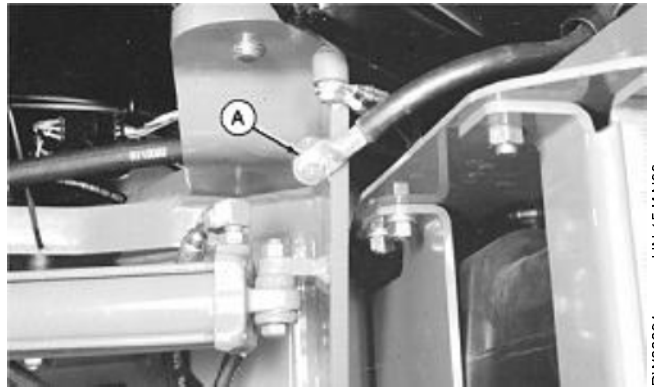

RW22284  
-JUN-15JAN93

3. Disconnect SGB ground wire (B) at rear of SGB.

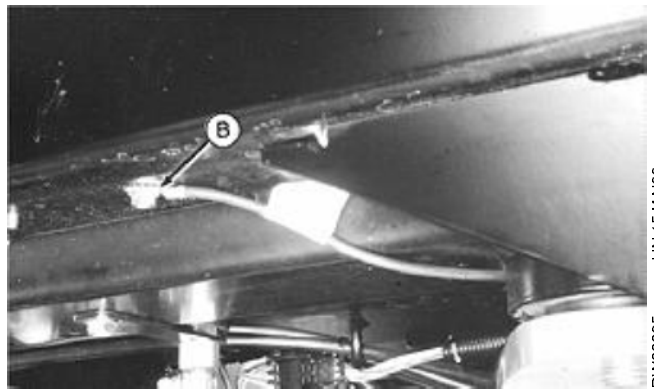

RW22285  
-JUN-15JAN93

RX15491520,1 -19-24FEB93

4. Remove SGB floor mat (A).

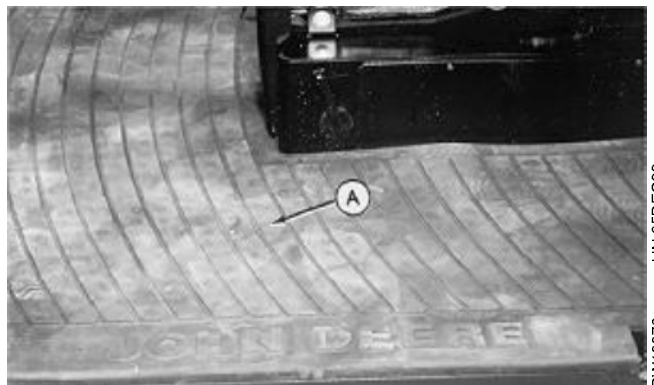

RW13976  
-JUN-05DEC88

RX15491520,2 -19-24FEB93

**For tractors with PowrSync transmission, perform Steps 4a, 4b, 4c, and 4d.**

4a. Remove side cover on shift console.

4b. Remove floor plate (A).

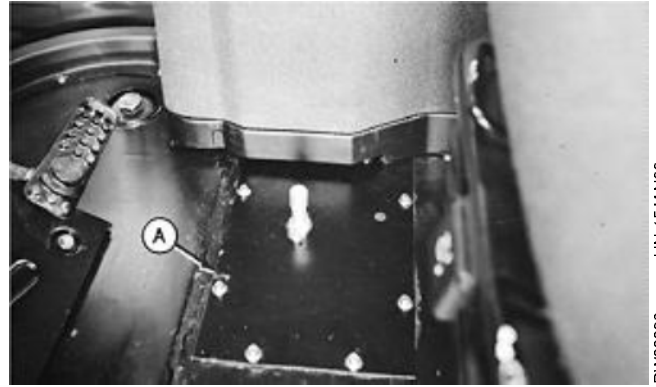

RX15491520.3 -19-09MAR93

RW22286  
-JUN-15JAN93

4c. Remove two bellcrank-to-transmission cap screws (B).

4d. Disconnect both shift linkages (A). If the transmission is going to be removed, disconnect the shift linkages at right side of transmission and clutch cable on left side of transmission.

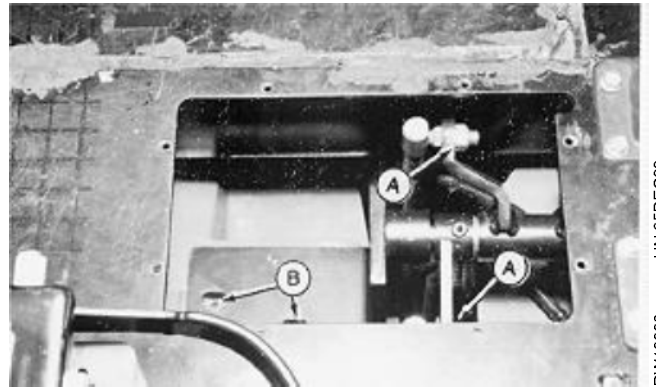

RX15491520.4 -19-24FEB93

RW13396  
-JUN-05DEC88

5. Remove control support cover (A).



RX15491520.5 -19-24FEB93

RW13978  
-JUN-05DEC88

6. Disconnect clutch control cable (A). Pull cable clear of SGB through grommet.



RX15491520.6 -19-24FEB93

RW13982  
-JUN-05DEC88

7. Remove pin (A) connecting brake valve to brake pedals.

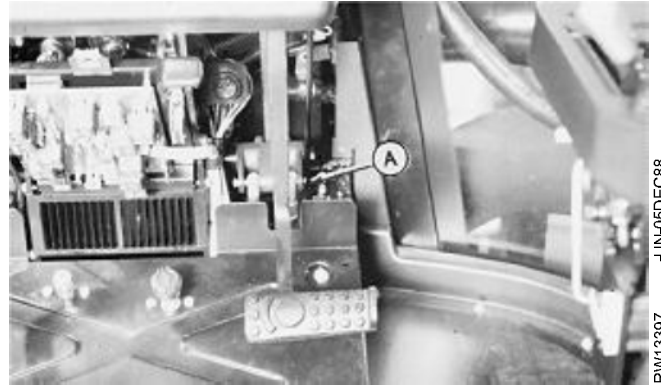

RX15491520,7 -19-24FEB93

RW13397 -JUN-05DEC88

8. Remove four SGB mounting cap screws, one in each corner (A). Remove plug in bottom of storage box to gain access to right rear mounting cap screws.



RX15491520,8 -19-24FEB93

RW13979 -JUN-05DEC88

9. Install JDG15 Lifting Bracket (A) to top of SGB.

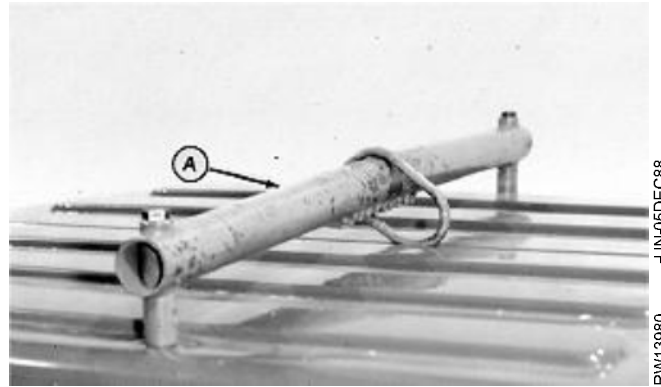

RX15491520,9 -19-24FEB93

RW13980 -JUN-05DEC88

10. Remove hood (A) and side shields (B).

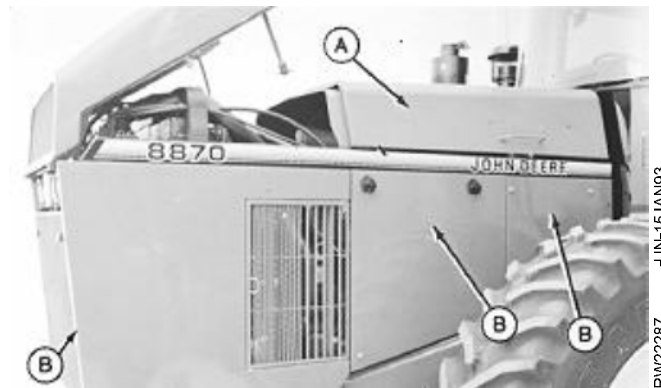

RX15491520,10 -19-24FEB93

RW22287 -JUN-15JAN93

15  
20  
4

11. Remove AQS air intake duct (A) at base of windshield.



RX15491520,11 -19-24FEB93

RW22288  
-JUN-15JAN93

12. Disconnect heater hoses (A) from AQS module.

13. Disconnect electrical connectors at left, rear lower corner of module.

14. Disconnect heater valve control cable.



RX15491520,12 -19-24FEB93

RW22289  
-JUN-15JAN93

15. Remove line clamp (A) from left hood rail.



RX15491520,13 -19-24FEB93

RW22290  
-JUN-15JAN93

16. Install lifting strap around end of pressurizer blower motor housing and through air filter collector drawer handle on molded AQS units.

17. Remove top cap screws, then bottom cap screws from the bulkhead.

18. Remove AQS module and carefully set unit on engine and hood rail.

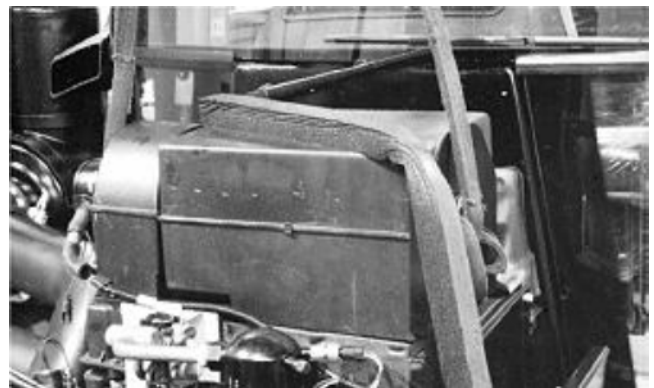

RX15491520,14 -19-24FEB93

RW19503  
-JUN-06JAN92

19. Disconnect bulkhead electrical connectors (A).

*NOTE: Electrical connector has a center attaching screw holding it to the bulkhead.*

20. Remove steering metering pump (B). DO NOT remove hoses from pump.

21. Remove brake valve (C). DO NOT remove hoses from valve.

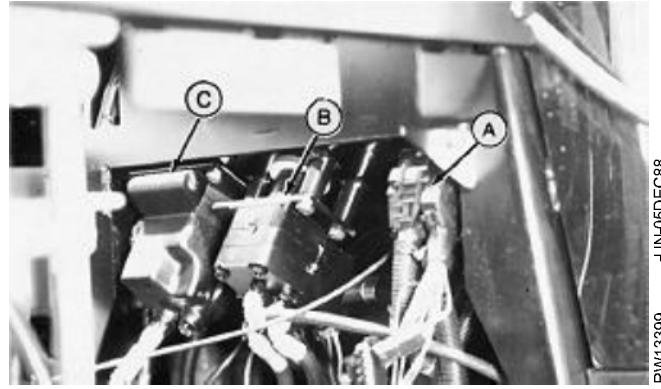

RX15491520,15 -19-24FEB93

RW13399 -JUN-05DEC88

22. Disconnect bulkhead electrical connector (A).

23. Disconnect SGB power cable (B).

24. Remove wiring harness clamp (C).

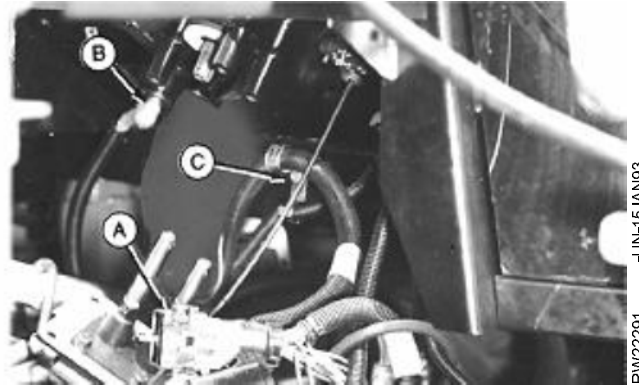

RX15491520,16 -19-24FEB93

RW22291 -JUN-15JAN93

**For tractors with POWER SHIFT transmission, perform Steps 24a and 24b.**

24a. Disconnect parking brake cable at front differential.

24b. Disconnect harness (A) at right rear of SGB.



RX15491520,17 -19-24FEB93

RW13361 -JUN-05DEC88

25. Disconnect SCV control cables (A), PTO control cable (if equipped) and remove with SGB.



RX15491520,18 -19-24FEB93

RW13993 -JUN-05DEC88

15  
20  
6



**Suggest:**

**If the above button click is invalid.**

**Please download this document first, and then click the above link to download the complete manual.**

**Thank you so much for reading**

26. Carefully remove SGB.

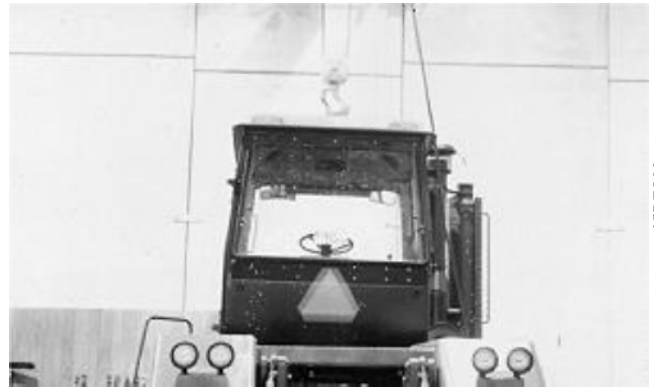

RX15491520,19 -19-24FEB93

RW13400 -JUN-05DEC88

## INSTALL SOUND-GARD BODY

**NOTE:** There is one black spacer-washer on each mount.

1. Carefully install SGB in reverse order of disassembly.

**CAUTION:** For tractors with MST, there must be clearance between top of bellcrank arm on the transmission shift linkage and the bottom of floor panel with the transmission in PARK position. Failure to do so could result in transmission slipping out of PARK. (See Adjust Transmission Shift Linkage, Section 50, Group 55.)

2. Install four lower mounting cap screws (A) and (B). DO NOT TIGHTEN.

3. Install two upper mounting cap screws (C) and tighten to 50 N·m (37 lb-ft).

4. Lift up on front portion of module (D) by hand and tighten two lower cap screws (B) to 50 N·m (37 lb-ft).

5. Tighten two remaining cap screws (A) to 50 N·m (37 lb-ft).

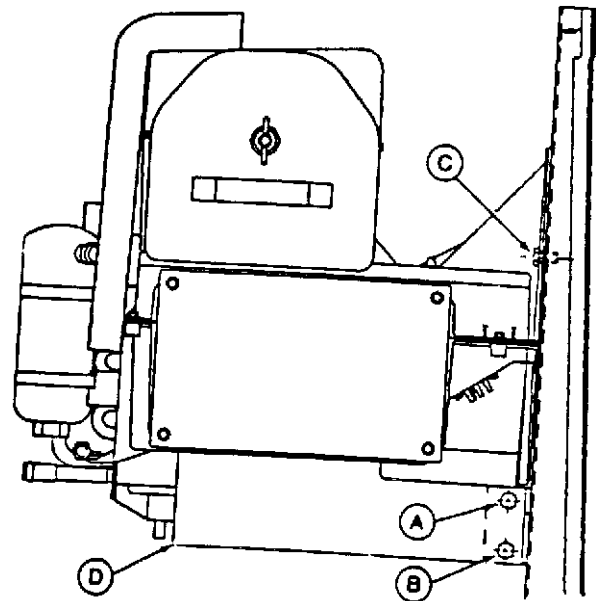

-JUN-15JAN93

RW22673

RX15491520,20 -19-24FEB93

**<https://www.ebooklibonline.com>**

Hello dear friend!

Thank you very much for reading.

Enter the link into your browser.

The full manual is available for immediate download.

**<https://www.ebooklibonline.com>**