

# **6100, 6500, 6600 Self-Propelled Sprayers**

**For complete service information also see:**

**3029, 4039, 4045,  
6059 and 6068 Engines . . . . . CTM8**

**Alternators and Starting Motors . . . . . CTM77**

**John Deere Des Moines Works  
TM1511 (05DEC97)**

LITHO IN U.S.A.  
ENGLISH

# Introduction

## FOREWORD

This manual is written for an experienced technician. Essential tools required in performing certain service work are identified in this manual and are recommended for use.

Live with safety: Read the safety messages in the introduction of this manual and the cautions presented throughout the text of the manual.



This is the safety-alert symbol. When you see this symbol on the machine or in this manual, be alert to the potential for personal injury.

Technical manuals are divided in two parts: repair and operation and tests. Repair sections tell how to repair the components. Operation and tests sections help you identify the majority of routine failures quickly.

Information is organized in groups for the various components requiring service instruction. At the beginning of each group are summary listings of all applicable essential tools, service equipment and tools, other materials needed to do the job, service parts kits, specifications, wear tolerances, and torque values.

Technical Manuals are concise guides for specific machines. They are on-the-job guides containing only the vital information needed for diagnosis, analysis, testing, and repair.

Fundamental service information is available from other sources covering basic theory of operation, fundamentals of troubleshooting, general maintenance, and basic type of failures and their causes.

# Contents

## SECTION 10—GENERAL INFORMATION

- Group 05—Safety
- Group 10—General Specifications
- Group 15—Fuels and Lubricants

## SECTION 20—ENGINE REPAIR

- Group 05—Remove and Install Engine
- Group 10—Cooling System

## SECTION 30—FUEL AND AIR SYSTEMS

- Group 05—Air Intake and Exhaust
- Group 10—Diesel Fuel System

## SECTION 40—ELECTRICAL REPAIR

- Group 05—Battery
- Group 10—Starting System
- Group 15—Charging System
- Group 20—Engine Electrical Components
- Group 25—Lights, Instruments, and Accessory Circuit Repair
- Group 30—Connector Repair
- Group 35—Machine Monitor System
- Group 40—Solution Control/Monitor System
- Group 45—Solution Pump Electric Clutch
- Group 50—Retractable Ladder

## SECTION 50—POWER TRAIN REPAIR

- Group 05—Remove and Install Hydrostatic Components
- Group 10—Hydrostatic Drive Repair
- Group 15—Power Wheel Repair

## SECTION 60—STEERING AND BRAKES

- Group 05—Remove and Install Steering Components
- Group 10—Steering Column Repair
- Group 15—Steering Valve Repair
- Group 20—Steering Motor—Single Wheel
- Group 25—Steering Cylinder—Wide Axle
- Group 30—Brake System Repair
- Group 35—Front Wheel and Axle

## SECTION 70—HYDRAULIC SYSTEM

- Group 05—Hydraulic Pump
- Group 10—Hydraulic Valves
- Group 15—Hydraulic Cylinders
- Group 20—Hydraulic Filter/Manifold
- Group 25—Oil Cooler
- Group 30—Hydraulic Reservoir

## SECTION 80—SOLUTION SPRAY SYSTEM

- Group 05—Nozzle Repair
- Group 10—Solution Tank
- Group 15—Solution Pump
- Group 20—Solution Control Valves

## SECTION 90—OPERATOR'S STATION REPAIR

- Group 05—R-12 Air Conditioning System Service
- Group 06—R134a Air Conditioning System Service
- Group 10—R-12 Air Conditioning System Repair
- Group 11—R134a Air Conditioning System Repair
- Group 15—Air Intake (Pressurizer) System Repair
- Group 20—Seat Repair
- Group 25—Operator's Cab
- Group 30—Controls
- Group 35—Cab Heater (If Equipped)

## SECTION 220—ENGINE OPERATION AND TESTS

- Group 10—Diagnostic Information

## SECTION 230—FUEL/AIR OPERATION AND TESTS

- Group 10—Diagnostic Information

## SECTION 240—ELECTRICAL SYSTEM OPERATION, TESTS AND ADJUSTMENTS

- Group 01—Theory of Operation
- Group 02—Electrical Diagrams
- Group 03—Diagnostic Information
- Group 05—Charging System
- Group 10—Starting System
- Group 15—Lights and Accessories
- Group 16—Fuses and Relays

Continued on next page

*All information, illustrations and specifications in this manual are based on the latest information available at the time of publication. The right is reserved to make changes at any time without notice.*

TM1511-19-05DEC97

COPYRIGHT© 1997  
DEERE & COMPANY  
Moline, Illinois

All rights reserved  
A John Deere ILLUSTRATION® Manual  
Previous Editions  
Copyright 1996, 1994, 1993, 1992 Deere & Company

**<https://www.ebooklibonline.com>**

Hello dear friend!

Thank you very much for reading.

Enter the link into your browser.

The full manual is available for immediate download.

**<https://www.ebooklibonline.com>**

- Group 20—Machine Monitor System
- Group 24—Agitation Solenoid Valve System—6600
- Group 25—Solution Control System without (ERC)
- Group 26—Electronic Rate Control (ERC) Solution System
- Group 30—Air Conditioning System
- Group 31—Pressurizer/Blower System
- Group 35—Fuel Control System
- Group 40—Tread Adjust System (If Equipped)
- Group 45—Rear Fold Boom Control System
- Group 46—Front Fold Boom Control System
- Group 50—Ground Speed Control System
- Group 55—Auxiliary Hydraulics System (If Equipped)
- Group 60—Windshield Wiper System
- Group 65—Retractable Ladder System—6500, 6600
- Group 70—Air Seat System (If Equipped)

**SECTION 250—POWER TRAIN OPERATION AND TESTS**

- Group 05—System Operational Checks
- Group 10—Diagnostic Information
- Group 15—System Tests
- Group 20—System Adjustments
- Group 25—Theory of Operation

**SECTION 260—STEERING/BRAKES OPERATION, TESTS AND ADJUSTMENTS**

- Group 05—System Operational Checks
- Group 10—Diagnostic Information
- Group 15—System Tests
- Group 20—Adjustments
- Group 25—Theory of Operation

**SECTION 270—HYDRAULIC SYSTEM OPERATION, TESTS AND ADJUSTMENTS**

- Group 05—System Operational Checks
- Group 10—Diagnostic Information
- Group 15—System Tests
- Group 20—System Adjustments
- Group 25—Theory of Operation

**SECTION 280—SOLUTION SYSTEM OPERATION, TESTS AND ADJUSTMENTS**

- Group 05—System Operational Checks
- Group 10—Diagnostic Information
- Group 15—Tests
- Group 20—Adjustments
- Group 25—Theory of Operation

**SECTION 281—FOAM MARKER SYSTEM OPERATION, TESTS AND ADJUSTMENTS**

- Group 05—System Operational Checks
- Group 10—Diagnostic Information
- Group 15—Tests
- Group 25—Theory of Operation

**SECTION 290—OPERATOR'S STATION OPERATION, TESTS AND ADJUSTMENTS**

- Group 05—Operator's Station Operational Checks
- Group 10—Operator's Station Diagnostic Information
- Group 15—Operator's Station Tests
- Group 20—Adjustments
- Group 25—Operator Station Theory of Operation
- Group 30—Heater Theory of Operation

**SECTION 299—DEALER FABRICATED TOOLS**

- Group 00—Dealer Fabricated Tools

**Index**

# Section 10 GENERAL INFORMATION

## Contents

### Page

**Group 05—Safety** . . . . . 10-05-1

### **Group 10—General Specifications**

#### Machine Specifications

6100 . . . . . 10-10-1

6500 . . . . . 10-10-6

6600 . . . . . 10-10-11

#### Dimensions

6100 . . . . . 10-10-16

6500 Single Wheel . . . . . 10-10-18

6500 Wide Axle . . . . . 10-10-20

6600 . . . . . 10-10-21

Metric Cap Screw Torque Values . . . . . 10-10-24

Unified Inch Cap Screw Torque Values . . 10-10-25

Flat Face O-Ring Seal Fitting Torque

Chart . . . . . 10-10-26

Identification Numbers . . . . . 10-10-27

### **Group 15—Fuels and Lubricants**

Diesel Fuel . . . . . 10-15-1

Diesel Engine Oil . . . . . 10-15-2

Hydrostatic and Hydraulic Oils . . . . . 10-15-3

Final Drives . . . . . 10-15-4

Extreme Pressure Grease . . . . . 10-15-4

Hydraulic Brake Fluid . . . . . 10-15-5

Lubricant Storage . . . . . 10-15-5

Alternative and Synthetic Lubricants . . . . 10-15-5

Engine Coolant . . . . . 10-15-6

## RECOGNIZE SAFETY INFORMATION

This is the safety-alert symbol. When you see this symbol on your machine or in this manual, be alert to the potential for personal injury.

Follow recommended precautions and safe operating practices.

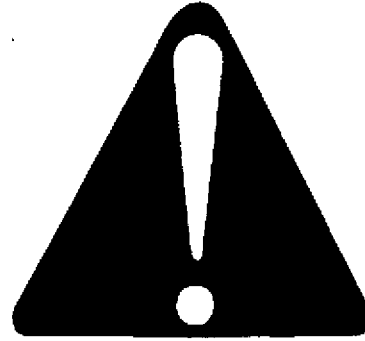

DX,ALERT -19-03MAR93

10  
05  
1  
T81389 -UN-07DEC88

## UNDERSTAND SIGNAL WORDS

A signal word—DANGER, WARNING, or CAUTION—is used with the safety-alert symbol. DANGER identifies the most serious hazards.

DANGER or WARNING safety signs are located near specific hazards. General precautions are listed on CAUTION safety signs. CAUTION also calls attention to safety messages in this manual.



DX,SIGNAL -19-03MAR93

TS187 -19-30SEP88

## FOLLOW SAFETY INSTRUCTIONS

Carefully read all safety messages in this manual and on your machine safety signs. Keep safety signs in good condition. Replace missing or damaged safety signs. Be sure new equipment components and repair parts include the current safety signs. Replacement safety signs are available from your John Deere dealer.

Learn how to operate the machine and how to use controls properly. Do not let anyone operate without instruction.

Keep your machine in proper working condition. Unauthorized modifications to the machine may impair the function and/or safety and affect machine life.

If you do not understand any part of this manual and need assistance, contact your John Deere dealer.

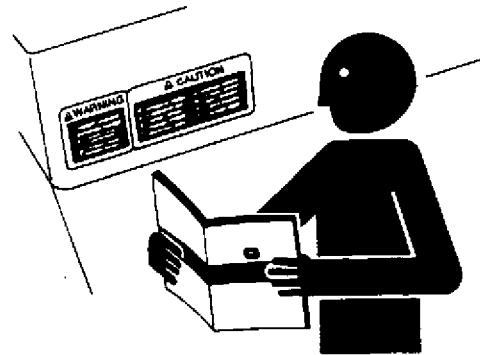

DX,READ -19-03MAR93

TS201 -UN-23AUG88

10  
05  
2

### HANDLE FLUIDS SAFELY—AVOID FIRES

When you work around fuel, do not smoke or work near heaters or other fire hazards.

Store flammable fluids away from fire hazards. Do not incinerate or puncture pressurized containers.

Make sure machine is clean of trash, grease, and debris.

Do not store oily rags; they can ignite and burn spontaneously.



DX,FLAME -19-04JUN90

-JUN-23AUG88  
TS227

### PREVENT BATTERY EXPLOSIONS

Keep sparks, lighted matches, and open flame away from the top of battery. Battery gas can explode.

Never check battery charge by placing a metal object across the posts. Use a volt-meter or hydrometer.

Do not charge a frozen battery; it may explode. Warm battery to 16°C (60°F).



DX,SPARKS -19-03MAR93

-JUN-23AUG88  
TS204

### PREPARE FOR EMERGENCIES

Be prepared if a fire starts.

Keep a first aid kit and fire extinguisher handy.

Keep emergency numbers for doctors, ambulance service, hospital, and fire department near your telephone.

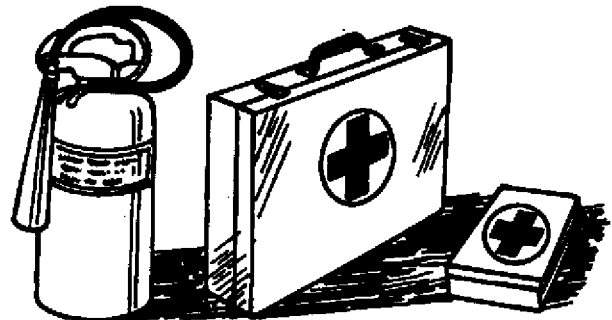

DX,FIRE2 -19-03MAR93

-JUN-23AUG88  
TS291

## REMOVE AND INSTALL MAIN DRIVE BELT

1. Remove wing nuts securing pump shield and lower shield to ground.
2. Move solution tank back. (See procedure in Section 80, Group 10.)
3. Remove solution pump drive belt. (See procedure in Section 80, Group 15.)
4. Loosen nut (B) on idler sheave tension rod (A) to release main drive belt tension.
5. Remove main drive belt.
6. Inspect main drive belt for wear or damage. Replace as necessary.
7. Install main drive belt.
8. Adjust main drive belt. (See procedure in Section 250, Group 20.)
9. Install solution pump drive belt. (See procedure in Section 80, Group 15.)
10. Move solution tank forward and install. (See procedure in Section 80, Group 10.)
11. Install pump shield and secure with wing nuts.

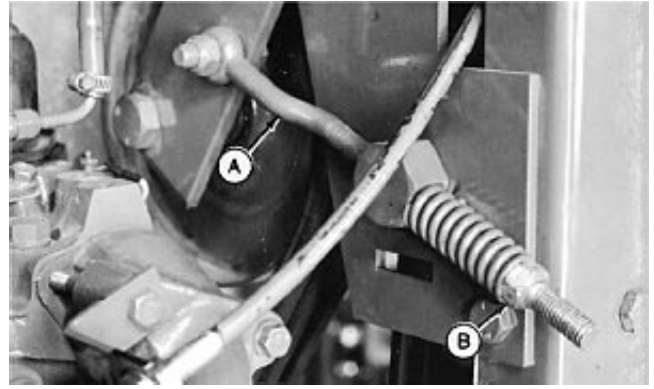

N44546  
-JUN-18JUN92

50  
05  
2

NX1511,5005,C -19-21FEB94

## REMOVE HYDROSTATIC DRIVE PUMP

6500 (SN —6000) shown throughout. 6100, 6500 (SN 6001— ) and 6600 procedures the same except where noted.

1. Extend tread width to access components.
2. Remove the solution tank. (See procedure in Section 80, Group 10.)
3. Clean the hydrostatic drive pump and its line connections.

*NOTE: Approximate capacity of reservoir is 34 L (9 gal.)*

4. Drain the hydraulic reservoir.
5. Remove plug (I) to drain pump.

*NOTE: Close all openings using caps and plugs.*

6. Remove line (A).

For 6100, 6500 (SN 6001— ), 6600: A hose is used in this location.

**IMPORTANT: Do not attempt to turn nut (D). Nut is brazed to line. Loosen nut (E) to disconnect lines (C) and (F).**

7. Remove retainers (H) and lines (C) and (F).
8. Disconnect hoses (B) and (G).

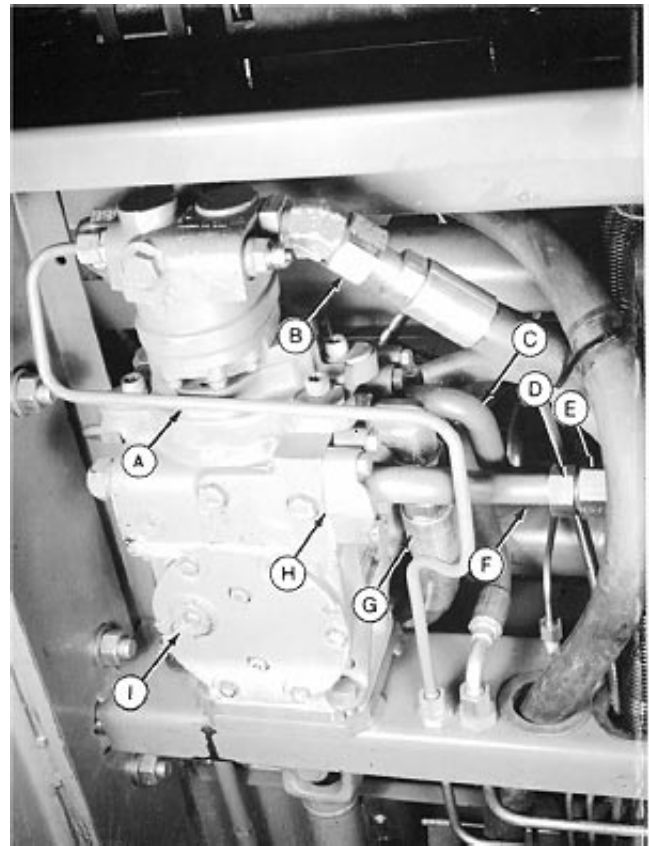

6500 (SN —6000) Shown

- A—Hydraulic Line 6500 (SN —6000)  
Hydraulic Hose 6100, 6500 (SN 6001— ),  
6600
- B—Hydraulic Hose
- C—Hydraulic Line
- D—Fixed Nut
- E—Connector Nut
- F—Hydraulic Line
- G—Hydraulic Hose
- H—Retainer (4 used)
- I—Drain Plug

NX1511,5005,D -19-25JUN97

Remove and Install Hydrostatic Components/Hydrostatic Drive Pump

9. Disconnect hose (A).

10. Disconnect line (B).

For 6100, 6500 (SN 6001— ), 6600: A hose is used in this location.

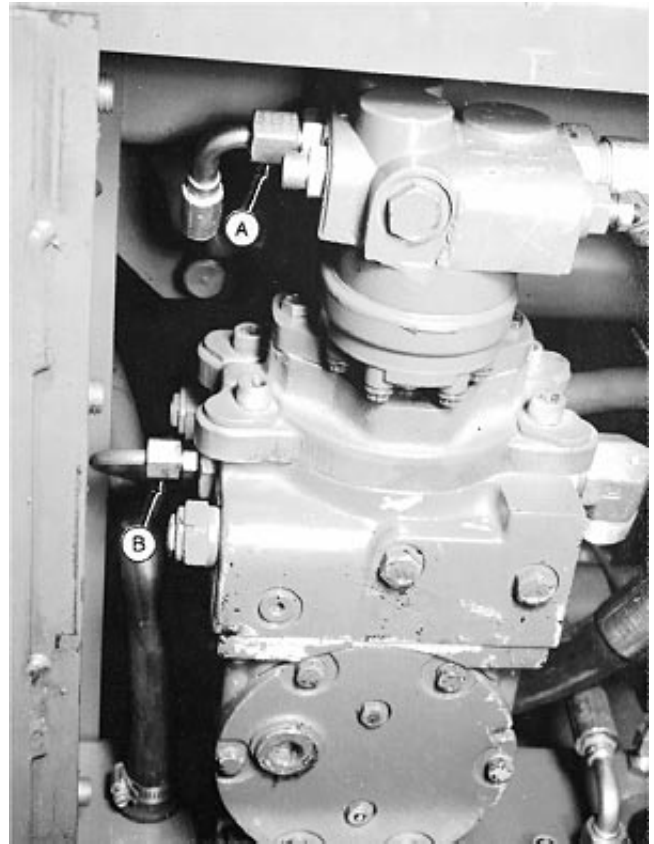

NX1511,5005,E -19-25JUN97

N44769 -UN-30JUL92

50  
05  
4

11. Disconnect neutral switch wiring connector (A).  
(Located at top of pump.)

12. Disconnect control cable (B).

13. Disconnect pump-to-oil cooler hose (C).

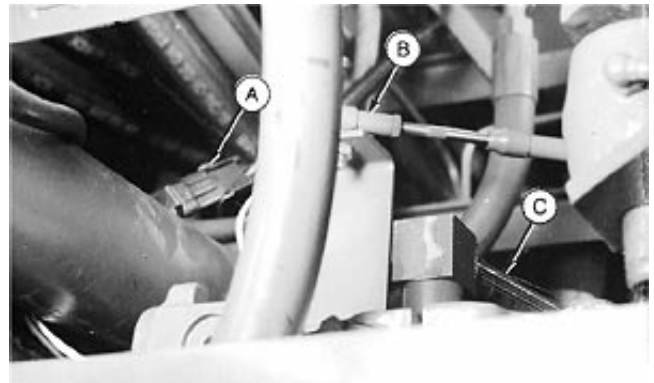

NX1511,5005,F -19-02NOV92

N44770 -UN-30JUL92

14. Loosen cap screws (A).

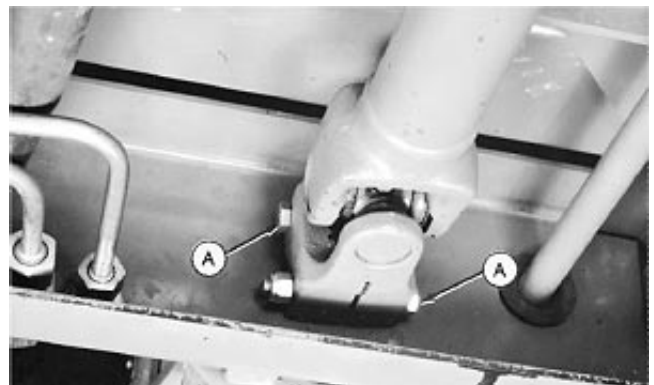

NX1511,5005,G -19-02NOV92

N44771 -UN-30JUL92

15. Remove three hydrostatic pump mounting cap screws and washers. Leave mounting cap screw (A) in place.

16. Install transmission jack under pump.

17. Remove remaining mounting cap screw (A) and washer.

*NOTE: Clearance is very close during pump removal. Remove hydraulic pump from hydrostatic pump, if necessary, to ease removal. (See procedure in Section 70, Group 05.)*

18. Remove hydrostatic pump.

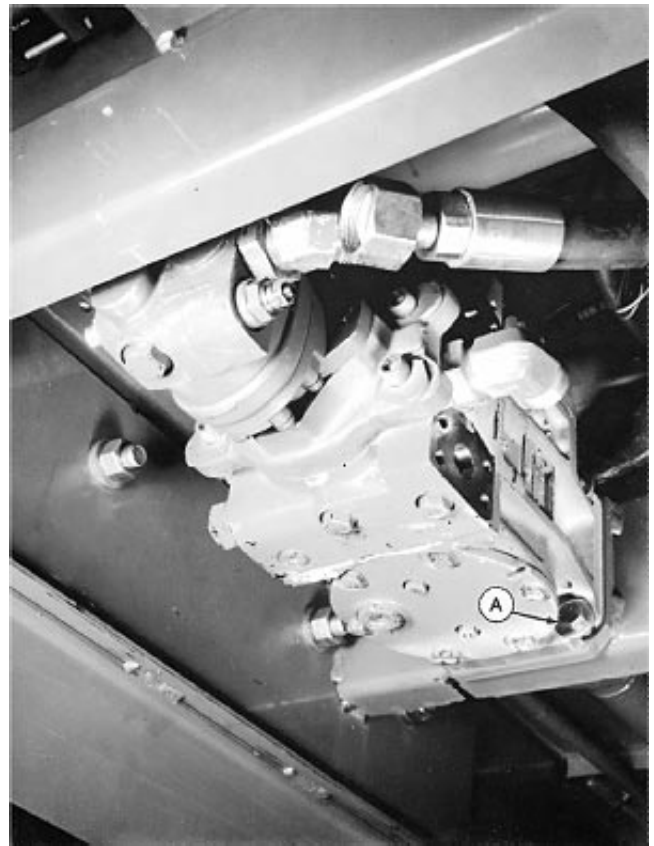

N44772 -JUN-30JUL92

50-5

NX1511,5005,H -19-25JUN97

## INSTALL HYDROSTATIC DRIVE PUMP

6500 (SN —6000) shown throughout. Procedures for 6100, 6500 (SN 6001— ), 6600 are the same except where noted.

1. Coat splines of hydrostatic pump input shaft with John Deere NEVER-SEEZ<sup>®</sup> Lubricant, or equivalent.

2. Use a transmission jack to install hydrostatic pump. (Pump input shaft must be connected to driveshaft yoke during pump installation.)

3. Install four washers and cap screws (A).



N44772 -JUN-30JUL92

NX1511,5005,I -19-25JUN97

Remove and Install Hydrostatic Components/Hydrostatic Drive Pump

4. Tighten cap screws (A).

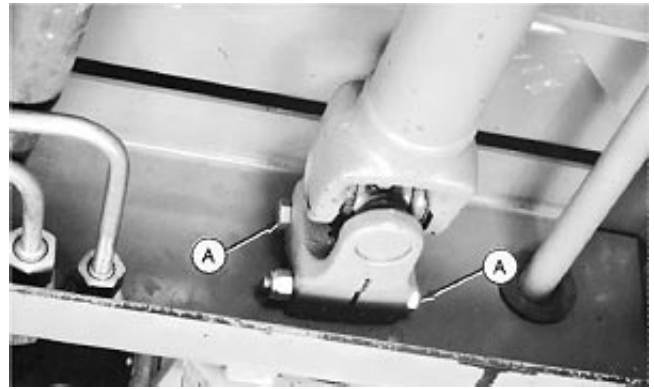

NX1511,5005,J1 -19-11NOV97

N44771  
-UN-30JUL92

5. Connect pump-to-oil cooler hose (C).

6. Connect control cable (B).

7. Connect wiring connector (A).

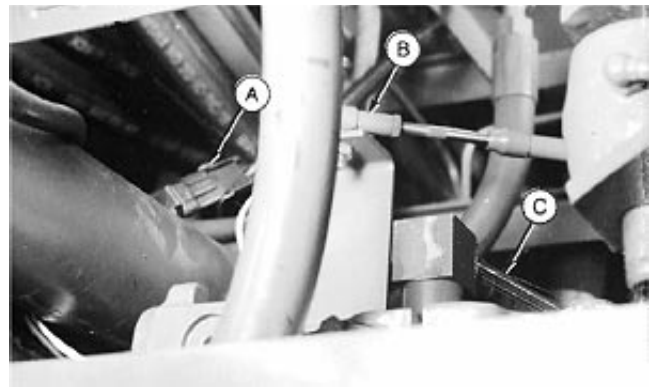

NX1511,5005,K -19-02NOV92

N44770  
-UN-30JUL92

**IMPORTANT: Replace all O-rings. Used or damaged O-rings can leak.**

8. Connect line (B), using new O-ring.

For 6100, 6500 (SN 6001— ), 6600: A hose is used in this location.

9. Connect hose (A), using new O-ring.

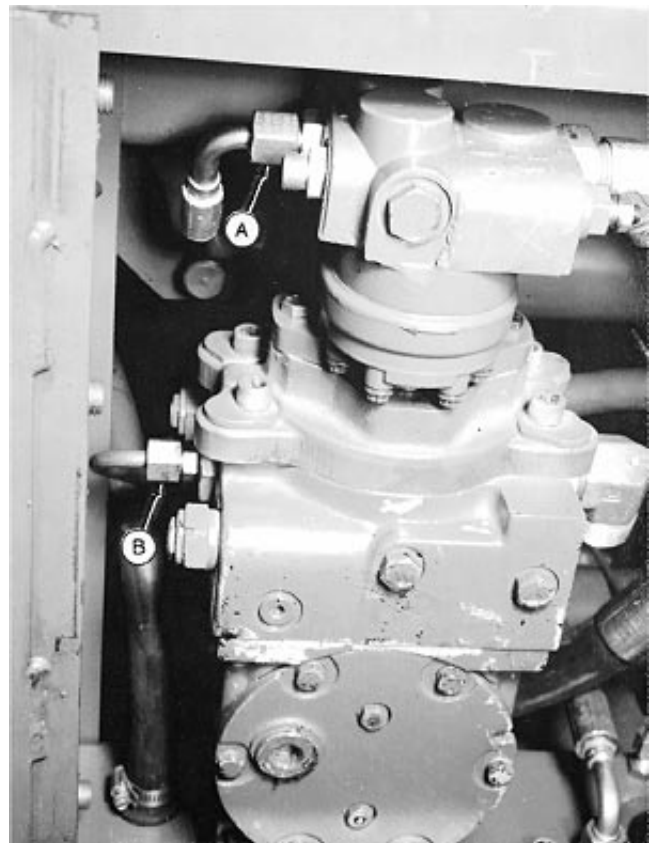

NX1511,5005,L -19-25JUN97

N44769  
-UN-30JUL92

10. Connect hoses (B) and (G) using new O-rings.
11. Install lines (C) and (F) using new O-rings, and retainers (H).
12. Install line (A) using new O-rings.

For 6100, 6500 (SN 6001— ) 6600: A hose is used in this location.

13. Tighten plug (I) to 27 N·m (20 lb-ft).

*NOTE: To prevent overfilling reservoir, retract all hydraulic cylinders before completely filling reservoir.*

14. Fill reservoir to sight glass with proper hydraulic oil. (See Section 10, Group 15.)

15. Adjust hydrostatic neutral linkage, if necessary. (See procedure in Section 250, Group 20.)

16. Install the solution tank. (See procedure in Section 80, Group 10.)

- |   |                  |
|---|------------------|
| A—Hydraulic Line 6500 (SN —6000)            | D—Fixed Nut      |
| Hydraulic Hose 6100, 6500 (SN 6001— ), 6600 | E—Connector Nut  |
| B—Hydraulic Hose                            | F—Hydraulic Line |
| C—Hydraulic Line                            | G—Hydraulic Hose |
|   | H—Retainer       |
|   | I—Drain Plug     |

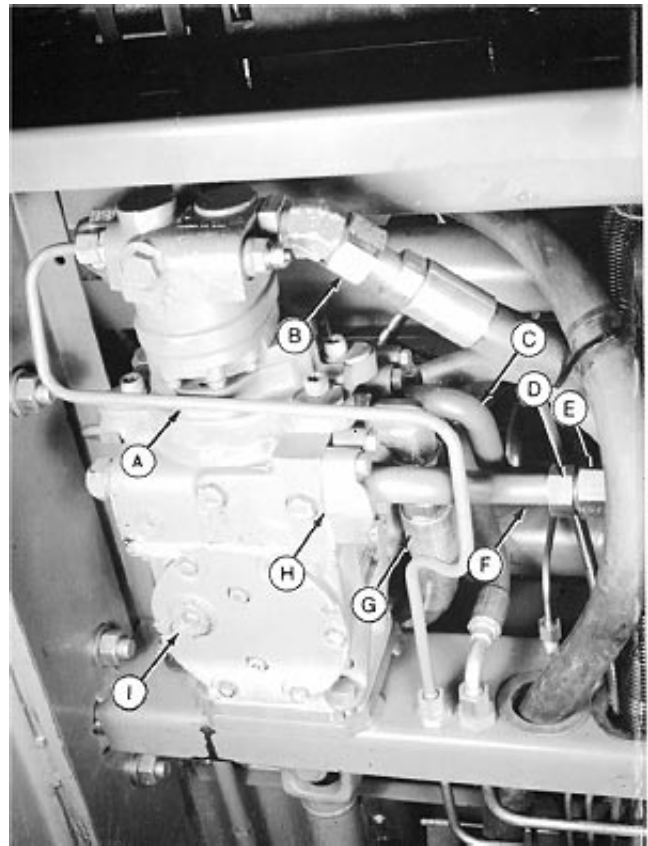

6500 (SN —6000) shown

NX1511,5005,M -19-25JUN97

## REMOVE DRIVE SHAFT

1. Remove solution tank. (See procedure in Section 80, Group 10.)
2. Remove nut (A) and spring.
3. Remove drive belt from drive shaft sheave.

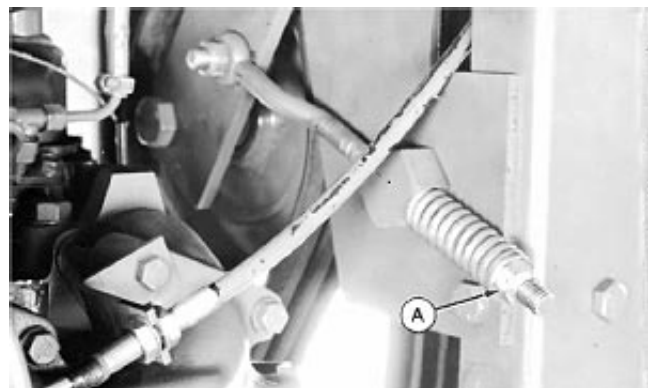

NX1511,5005,N -19-21FEB94

Remove and Install Hydrostatic Components/Drive Shaft

4. Loosen cap screws (A).

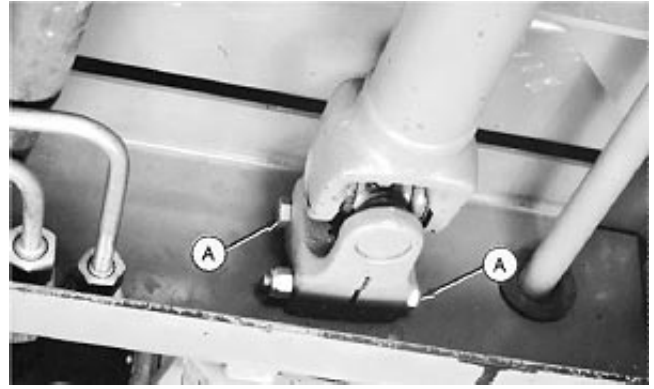

N44771 -UN-30JUL92

NX1511,5005,O -19-02NOV92

5. Remove nut and cap screw from hose clamp (C).

For 6500 (SN 6001— ): Remove sheave bracket retainer (D), cap screws (F), washers, nuts and bracket (E).

6. Remove nut and cap screw (A).

7. Remove four nuts (B), cap screws and washers.

8. Remove drive shaft assembly.

- A—Cap Screw (2 used)
- B—Nuts (4 used)
- C—Hose Clamp
- D—Sheave Bracket Retainer
- E—Bracket
- F—Cap Screws (2 used)

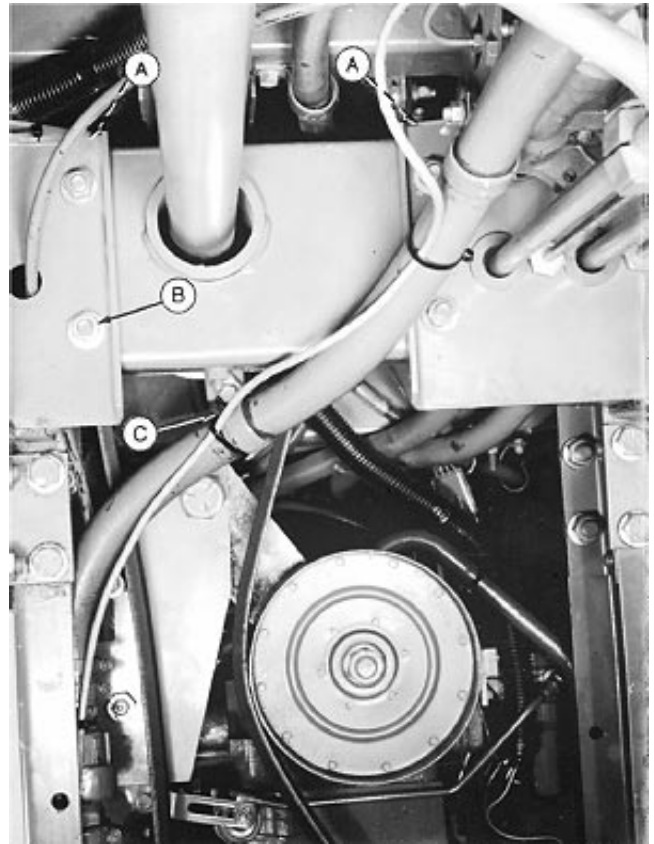

N44774 -UN-30JUL92

6500 (SN —6000) Shown

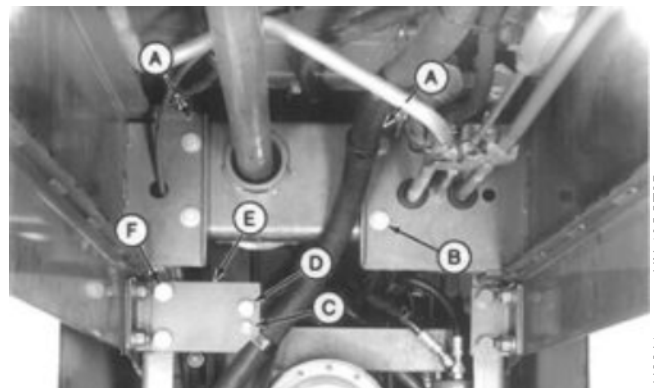

N48641 -UN-10OCT95

6500 (SN 6001— ) Shown

NX1511,5005,P -19-25JUN97

## INSTALL DRIVE SHAFT

1. Coat splines of drive shaft yoke with John Deere NEVER-SEEZ<sup>®</sup> lubricant or equivalent.
2. Install drive shaft assembly. Install yoke on hydrostatic pump input shaft.
3. Install cap screws, washers and nuts (B).
4. Install cap screws (A) and nuts.

For 6100, 6500 (SN 6001— ), 6600: Install bracket (E) using cap screws (F), washers and nuts. Install sheave bracket retainer (D).

5. Install clamp (C) using nut and cap screw.

- A—Cap Screws (2 used)
- B—Nuts (4 used)
- C—Hose Clamp
- D—Sheave Bracket Retainer
- E—Bracket
- F—Cap Screws (2 used)

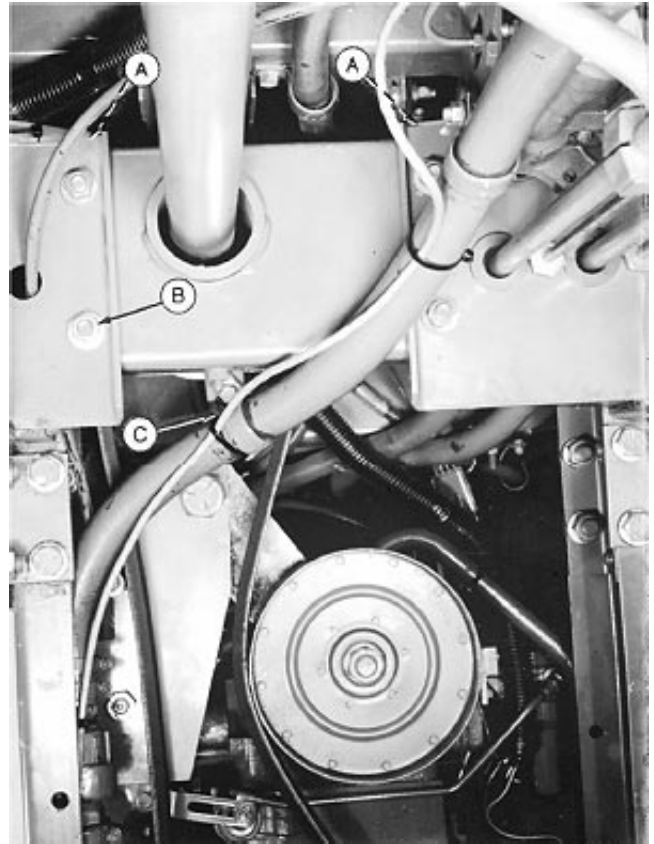

6500 (SN —6000) Shown

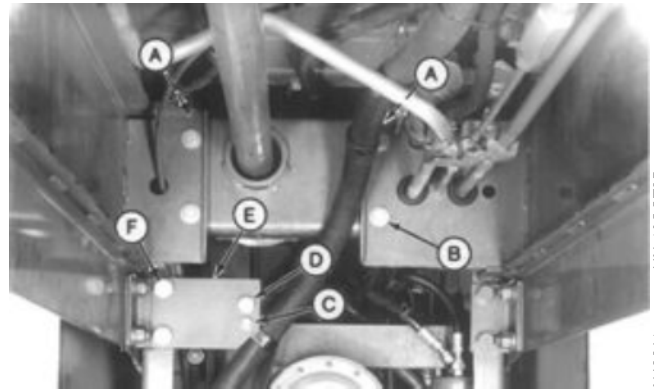

6500 (SN 6001— ) Shown  
NX1511,5005,Q -19-25JUN97

6. Tighten cap screws (A).

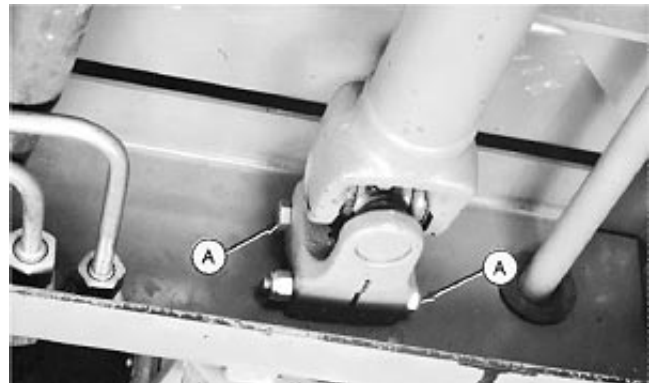

NX1511,5005,R -19-02NOV92

7. Install drive belt on drive shaft sheave.
8. Install spring and nut (A). Tighten nut to adjust idler spring to 61 mm (2.4 in.) and tension main drive belt.
9. Install solution tank. (See procedure in Section 80, Group 10.)

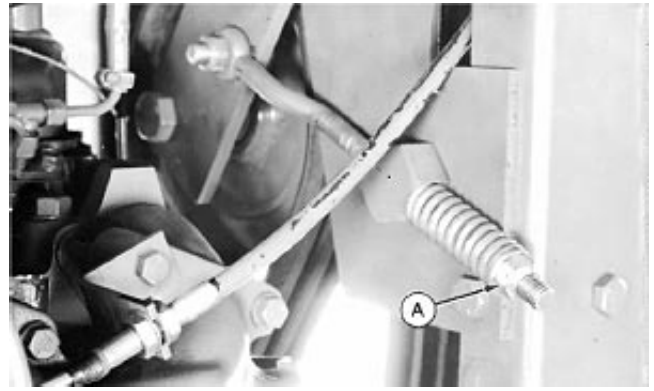

NX1511,5005,S -19-02NOV92

N44773 -JUN-30JUL92

## INSPECT DRIVE SHAFT

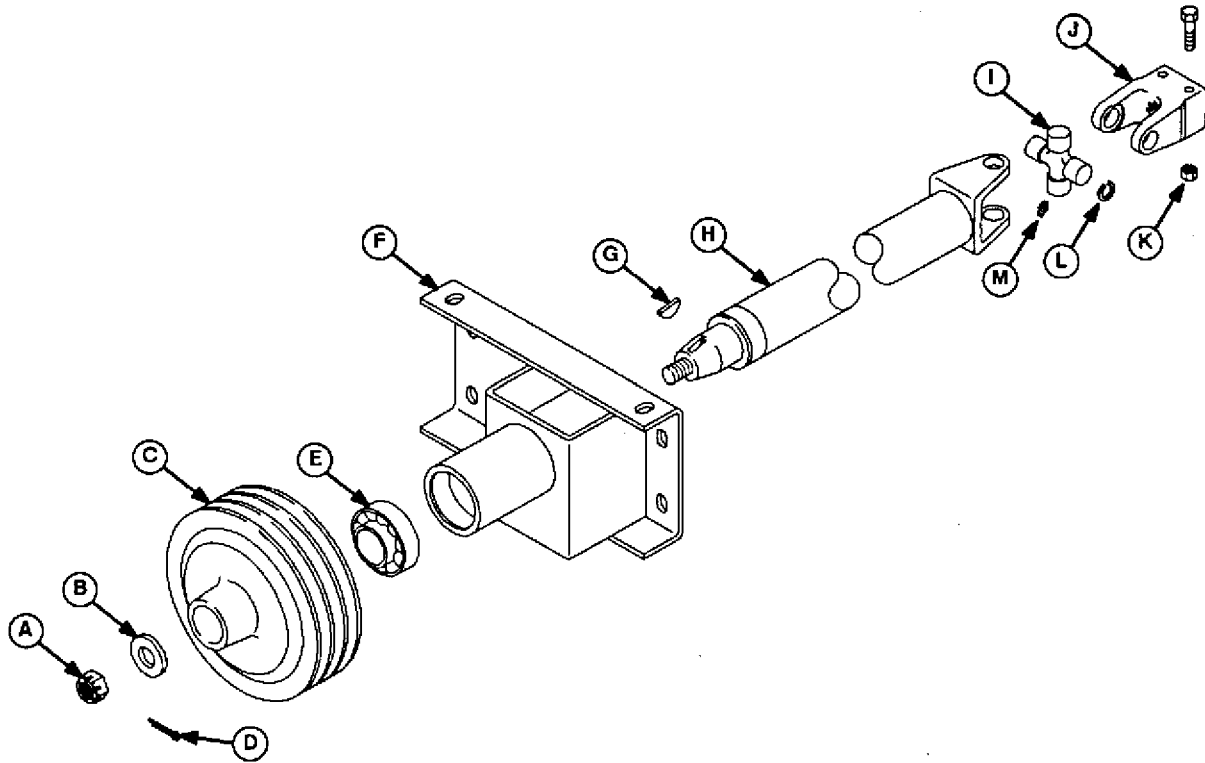

A—Castellated Nut  
B—Washer  
C—Sheave  
D—Cotter Pin

E—Bearing  
F—Bracket  
G—Woodruff Key

H—Drive Shaft  
I—Cross  
J—Yoke

K—Lock Nut (2 used)  
L—Snap Ring  
M—Lubrication Fitting

Inspect parts (A—M) for wear or damage. Inspect bearing (E) for smooth operation, driveshaft for

straightness and splines of yoke (J) for damage. Replace parts as necessary.

NX1511,5005,T -19-21NOV95

N44775 -JUN-03AUG92

## REMOVE AND INSTALL MANIFOLD—6500 (SN —6000)

*NOTE: Approximate capacity of reservoir is 34 L (9 gal.).*

1. Drain reservoir.
2. Remove walking cover.
3. Label lines and hoses to aid in connection. Disconnect all lines and hoses from manifold. Close all openings using caps and plugs.

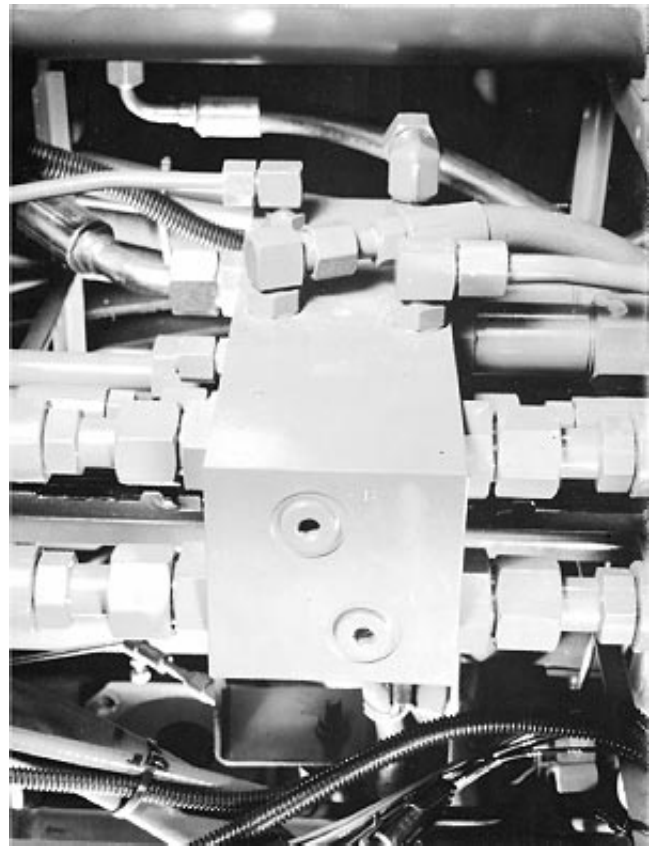

NX1511,5005,U -19-25JUN97

N44776 -JUN-30JUL92

50-05-11

4. Disconnect solenoid valve wiring connector (B), located at bottom of manifold.
5. Remove four cap screws (A). Remove manifold.
6. Inspect manifold for cracks or damage. Remove ground speed solenoid valve, if necessary. (See procedure in this group.)
7. Install manifold using cap screws.
8. Connect wiring connector.



NX1511,5005,V -19-21NOV95

N44777 -JUN-30JUL92

**IMPORTANT: Replace all O-rings. Used or damaged O-rings can leak.**

9. Connect all lines and hoses using new O-rings, as shown.

*NOTE: To prevent overfilling, retract all hydraulic cylinders before completely filling reservoir.*

10. Fill reservoir to sight glass with proper hydraulic oil. (See Section 10, Group 15.)

11. Operate all hydraulic functions and check manifold connections for leaks.

12. Install walking cover.

- A—LMA Port-to-Left Wheel Motor (rear fitting)
- B—LMB Port-to-Left Wheel Motor (front fitting)
- C—LC Port-to-Left Wheel Motor (lower fitting)
- D—LT Port-to-Left Wheel Motor (upper fitting)
- E—PA Port-to-Hydrostatic Pump A Port
- F—PB Port-to-Hydrostatic Pump B Port
- G—T Port-to-Reservoir
- H—R Port-to-Filter
- I—GR Plug
- J—RT Port-to-Right Wheel Motor (upper fitting)
- K—RC Port-to-Right Wheel Motor (lower fitting)
- L—RMA Port-to-Right Wheel Motor (front fitting)
- M—RMB Port-to-Right Wheel Motor (rear fitting)
- N—R Port-to-Tread Adjust Valve T Port
- O—R Port-to-Auxiliary Valve T Port
- P—GC Plug
- Q—C Port-to-Hydrostatic Pump
- R—R Port-to-Boom Control Valve T Port
- S—Plug
- T—Plug
- U—Ground Speed Solenoid Valve
- V—R Port-to-Steering Return Line (at crossmember)

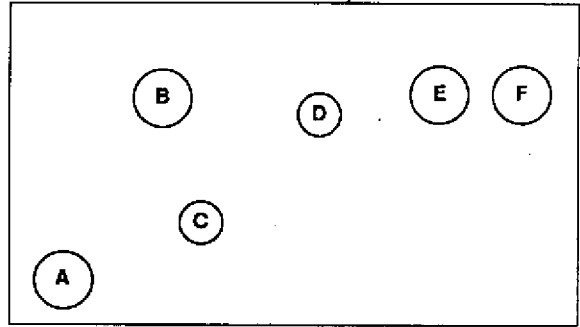

Right Side

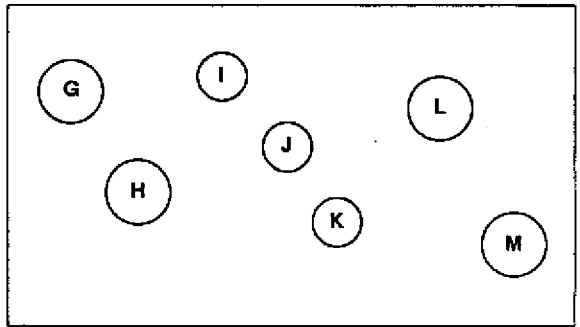

Left Side

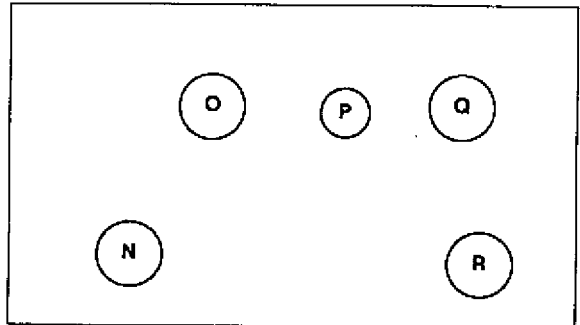

Top

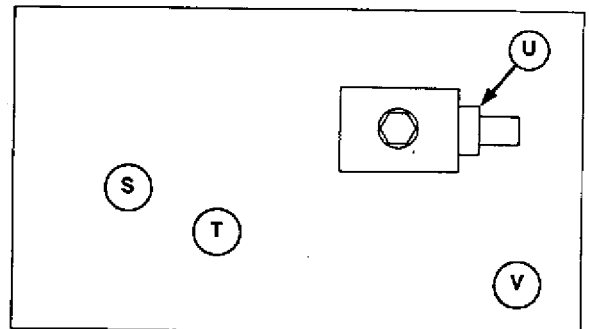

Bottom

-UN-03AUG92  
 N44778  
 -UN-03AUG92  
 N44779  
 -UN-03AUG92  
 N44780  
 -UN-03AUG92  
 N44781

50  
 05  
 12

## REMOVE AND INSTALL GROUND SPEED SOLENOID VALVE—6500 (SN —6000)

*NOTE: Approximate capacity of reservoir is 34 L (9 gal).*

1. Drain the hydraulic reservoir.

*NOTE: Ground speed solenoid valve is located on bottom of manifold.*

2. Disconnect wiring connector (B).
3. Remove two cap screws (A). Remove valve.
4. Inspect valve. (See procedure in this group.) Replace if necessary.
5. Install valve.
6. Connect wiring connector.

*NOTE: To prevent overfilling, retract all hydraulic cylinders before completely filling reservoir.*

7. Fill reservoir to level of sight glass using proper hydraulic oil. (See Section 10, Group 15.)

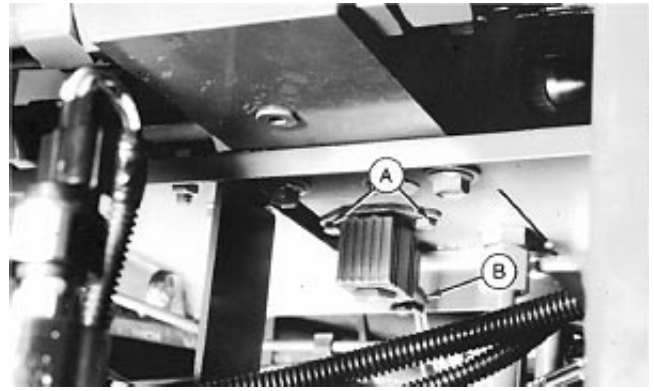

N44782 -UN-30JUL92

NX1511,5005.X -19-25JUN97

## INSPECT GROUND SPEED SOLENOID VALVE—6500 (SN —6000)

1. Remove nut (A).
2. Remove solenoid (B) and clamp (C).

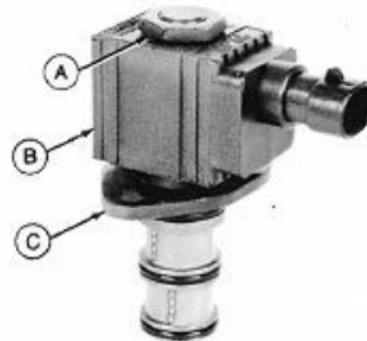

N44783 -UN-30JUL92

NX1511,5005.Y -19-25JUN97

Remove and Install Hydrostatic Components/Ground Speed Solenoid Valve

3. Remove parts (A—H).
4. Clean and inspect parts for wear or damage. Replace valve if necessary.
5. Replace all O-rings.
6. Install parts.

- A—Valve Body
- B—O-Ring
- C—O-Ring
- D—O-Ring
- E—Spring
- F—Plunger
- G—Spool
- H—Snap Ring

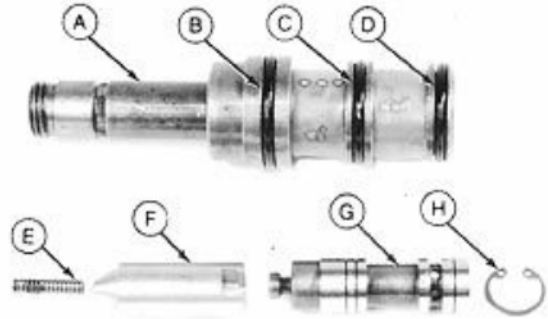

NX1511,5005,Z -19-21NOV95

-UN-30JUL92  
N44784

7. Install parts (A—C). Tighten nut (A) to 6 N·m (53 lb-in.).

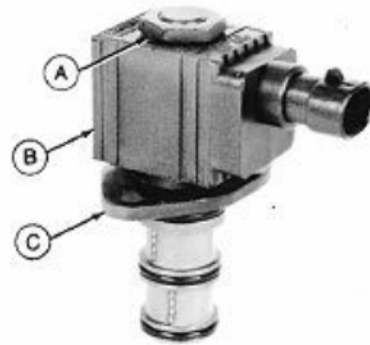

NX1511,5005,AA -19-02NOV92

-UN-30JUL92  
N44783

50  
05  
14

## REMOVE AND INSTALL GROUND SPEED SOLENOID VALVE—6100, 6500 (SN 6001— ), 6600

*NOTE: Approximate capacity of reservoir is 34 L (9 gal).*

1. Drain the hydraulic reservoir.
2. Disconnect wiring connector (F).
3. Remove hoses (A, B, D and E). Cap and plug all openings.
4. Remove cap screws, washers, nuts (C) and valve.
5. Install valve using cap screws, washers and nuts.
6. Install all hoses and wiring connector.
7. Fill hydraulic reservoir to center of sight glass with recommended oil. (See Section 10, Group 15.)

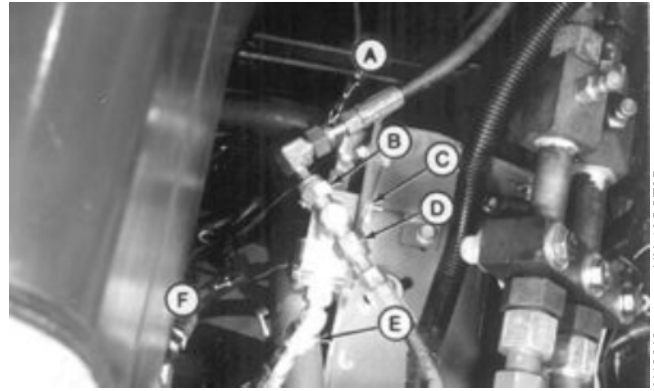

A—Hose to Reservoir  
B—Hose to Right Wheel Motor  
C—Nut (2 used)  
D—Hose to Left Wheel Motor  
E—Hose from Hydrostatic Pump  
F—Wire Connector to Solenoid

NX1511,5005,AC -19-25JUN97

N48648 -JUN-10OCT95

50  
05  
15

## DISASSEMBLE AND ASSEMBLE GROUND SPEED SOLENOID VALVE—6100, 6500 (SN 6001— ), 6600

*NOTE: Record orientation of fittings-to-valve housing before removing them, to aid in assembly.*

1. Remove fittings (C—E).
2. Remove nut (A) and solenoid coil assembly (F).
3. Remove solenoid valve (B).

A—Nut  
B—Solenoid Valve  
C—90° Fitting  
D—T-Fitting  
E—45° Fitting  
F—Coil Assembly

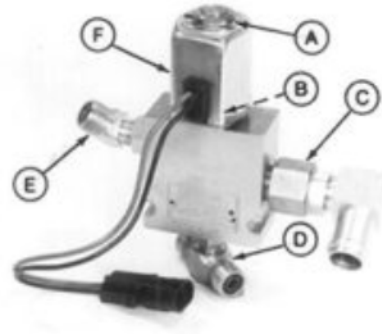

NX1511,5005,AD -19-25JUN97

N48649 -JUN-10OCT95

Remove and Install Hydrostatic Components/Ground Speed Solenoid Valve

4. Remove parts (A—E).

5. Clean and inspect solenoid valve (F) for wear or damage. Replace valve if necessary.

6. Replace all O-rings and backup rings with new. Used or damaged O-rings will leak.

7. Clean and inspect valve housing for cracks or damaged threads. Replace valve housing if necessary.

- A—O-Ring
- B—Backup Ring
- C—Backup Ring
- D—O-Ring
- E—O-Ring
- F—Solenoid Valve

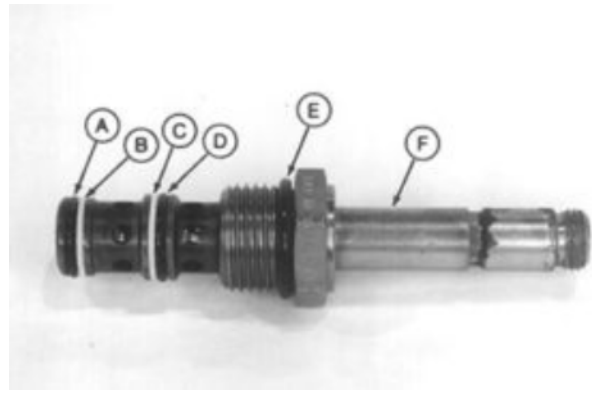

-JUN-10OCT95  
N48650

NX1511,5005,AE -19-21NOV95

8. Install fittings into valve housing (A). Position fittings as they were before removal.

50  
05  
16

9. Lubricate solenoid valve (B) to top of threads using clean hydraulic oil.

10. Install valve and tighten to 47 N·m (35 lb-ft).

*NOTE: Tighten solenoid valve nut to specifications. Overtightening nut can cause valve failure.*

11. Install parts (C—G). Tighten nut (G) to 6.5 N·m (60 lb-in.) maximum.

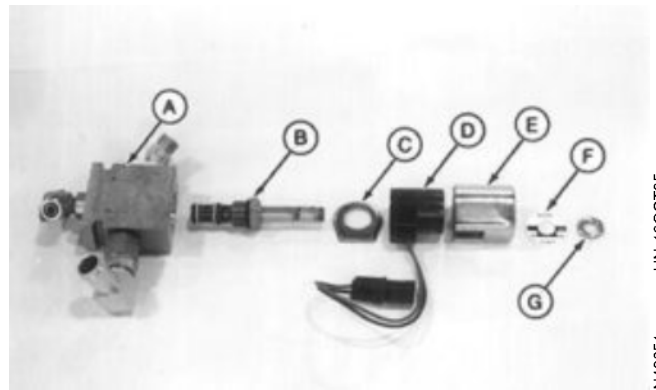

-JUN-10OCT95  
N48651

- A—Valve Housing
- B—Solenoid Valve
- C—Base Plate
- D—Coil
- E—Coil Housing
- F—Identification Plate
- G—Nut

NX1511,5005,AF -19-21NOV95



**Suggest:**

**If the above button click is invalid.**

**Please download this document**

**first, and then click the above link**

**to download the complete manual.**

**Thank you so much for reading**

## REMOVE AND INSTALL HYDROSTATIC DRIVE MOTOR

1. Remove brake disc and caliper. (See procedure in Section 60, Group 30.)
2. Remove bracket (B) (if equipped).

*NOTE: When disconnecting hose (G), be careful not to lose restrictor plate with O-ring (H).*

3. Disconnect hose (G). Remove restrictor plate with O-ring (H).
4. Disconnect hoses (D—F). Close all openings with caps and plugs.

**CAUTION:** Approximate weight of motor is 23 kg (51 lbs).

5. Remove two nuts (C).
6. Remove motor and O-ring.
7. Apply petroleum jelly to new O-ring and install motor.
8. Install nuts and tighten to 115 N·m (85 lb-ft).
9. Connect hoses (D—F).
10. Connect hose (G), making sure restrictor plate with O-ring (H) is installed in fitting.
11. Install bracket (B) (if equipped).
12. Install brake disk and caliper. (See procedure in Section 60, Group 30.)

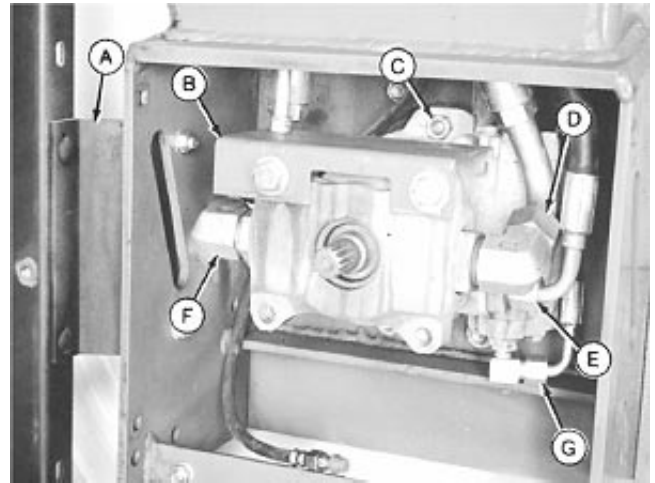

Right Side Shown



- A—Support
- B—Park Brake Cable Bracket (if equipped)
- C—Nut (2 used)
- D—Hydraulic Hose
- E—Hydraulic Hose
- F—Hydraulic Hose
- G—Hydraulic Hose
- H—.028 in. Orifice Restrictor Plate with O-Ring

NX1511,5005,AB -19-21NOV95

N44245 -JUN-18JUN92

-JUN-18JUN92

N44246

50  
05  
17

**<https://www.ebooklibonline.com>**

Hello dear friend!

Thank you very much for reading.

Enter the link into your browser.

The full manual is available for immediate download.

**<https://www.ebooklibonline.com>**