

# **4430 and 4630 Tractors**

## **TECHNICAL MANUAL**

4430 and 4630  
Tractors

# 4430 AND 4630 TRACTORS TECHNICAL MANUAL TM-1172 (JAN-77)

## CONTENTS

### SECTION 10—GENERAL

- Group 5—General Tractor Specifications
- Group 10—Predelivery, Delivery, and After-Sale Services
- Group 15—Tune-Up
- Group 20—Lubrication
- Group 25—Separation
- Group 30—Specifications

### SECTION 20—ENGINE

- Group 5—General Information and Diagnosis
- Group 10—Cylinder Head, Valve Train, and Camshaft
- Group 15—Cylinder Block, Liners, Pistons, and Rods
- Group 20—Crankshaft, Main Bearings, and Flywheel
- Group 25—Lubricating System
- Group 30—Cooling System
- Group 35—Specifications

### SECTION 30—FUEL SYSTEM

- Group 5—Diagnosing Malfunctions
- Group 10—Air Intake System
- Group 15—Diesel Fuel System
- Group 20—Speed Control Linkage
- Group 25—Specifications and Special Tools

### SECTION 40—ELECTRICAL SYSTEM

- Group 5—Information and Wiring Diagrams
- Group 10—Delcotron Charging Circuit
- Group 15—Delco-Remy Starting Circuit
- Group 20—John Deere Starting Circuit
- Group 25—Lighting and Accessory Circuits
- Group 30—Specifications

### SECTION 50—POWER TRAIN

- Group 5—Perma-Clutch
- Group 10—PTO, Perma-Clutch
- Group 15—Syncro-Range Transmission
- Group 20—Creeper Transmission
- Group 25—Quad-Range Transmission
- Group 30—Power Shift Transmission
- Group 35—PTO, Power Shift
- Group 40—Differential
- Group 45—Final Drive
- Group 50—Hi-Crop Final Drive
- Group 55—Power Front-Wheel Drive
- Group 60—Specifications

### SECTION 60—STEERING AND BRAKES

- Group 5—General Information

### SECTION 70—HYDRAULIC SYSTEM

- Group 5—General Information
- Group 6—Testing and Diagnosis
- Group 10—Miscellaneous Hydraulic Components
- Group 15—Hydraulic Pumps
- Group 20—Power Steering
- Group 25—Power Brakes
- Group 30—Rockshaft and Implement Hitches
- Group 35—Selective Control Valve, Breakaway Couplers, and Remote Cylinders
- Group 40—Specifications

### SECTION 80—SOUND-GARD BODY

- Group 5—Air Conditioning System
- Group 10—Heating System
- Group 15—Seat
- Group 20—Miscellaneous Components
- Group 25—Specifications

### SECTION 90—MISCELLANEOUS

- Group 5—Front Axles
- Group 10—Wheels
- Group 15—Specifications

*All information, illustrations and specifications contained in this technical manual are based on the latest information available at the time of publication. The right is reserved to make changes at any time without notice.*

## INTRODUCTION

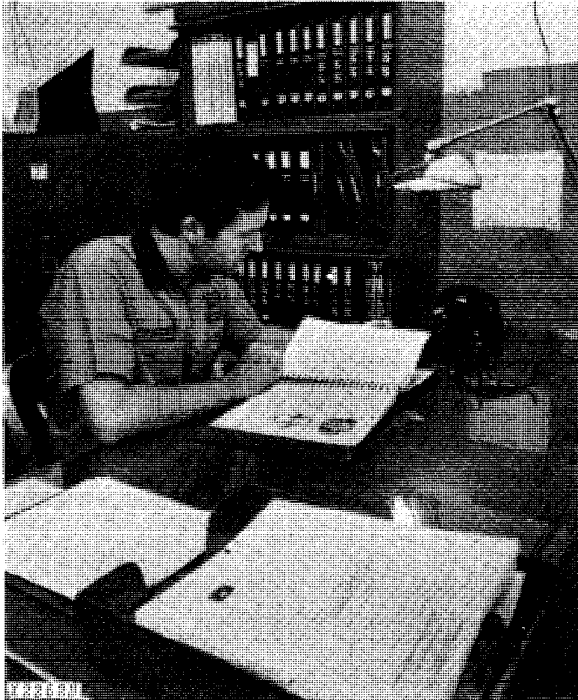

Use FOS Manuals for Reference

This technical manual is part of a twin concept of service:

- **FOS Manuals—for reference**
- **Technical Manuals—for actual service**

The two kinds of manuals work as a team to give you both the general background and technical details of shop service.

*Fundamentals of Service (FOS) Manuals* cover basic theory of operation, *fundamentals* of trouble shooting, *general* maintenance, and *basic* types of failures and their causes. FOS Manuals are for training new men and for reference by experienced men.

*Technical Manuals* are concise service guides for a specific machine. Technical Manuals are on-the-job guides containing only the vital information needed by a journeyman mechanic.



When a serviceman should refer to a FOS Manual for more information, a FOS symbol like the one at the left is used in the TM to identify the reference.



Use Technical Manuals for Actual Service

Some features of this technical manual:

- *Table of contents at front of manual*
- *Exploded views showing parts relationship*
- *Photos showing service techniques*
- *Specifications grouped for easy reference*

This technical manual was planned and written for you—a journeyman mechanic. Keep it in a permanent binder in the shop where it is handy. Refer to it whenever in doubt about correct service procedures or specifications.

Using the technical manual as a guide will reduce error and costly delay. It will also assure you the best in finished service work.



This safety alert symbol identifies important safety messages in this manual. When you see this symbol, be alert to the possibility of personal injury and carefully read the message that follows.

**<https://www.ebooklibonline.com>**

Hello dear friend!

Thank you very much for reading.

Enter the link into your browser.

The full manual is available for immediate download.

**<https://www.ebooklibonline.com>**

## Section 10 GENERAL

### CONTENTS OF THIS SECTION

	Page		Page
GROUP 5—SPECIFICATIONS		GROUP 25—SEPARATION	
General Tractor Specifications .....	5-1	Removing Sound-Gard Body without	
GROUP 10—PREDELIVERY, DELIVERY,		Control Support .....	25-1
AND AFTER-SALES SERVICE		Removing Sound-Gard Body with	
Before Unloading Tractor .....	10-1	Control Support .....	25-6
Predelivery Services .....	10-4	Separating Engine from	
Delivery Services .....	10-20	Clutch Housing .....	25-11
After-Sale Services .....	10-21	Removing Engine from Front End .....	25-15
GROUP 15—TUNE-UP		Removing Front End (4430) .....	25-19
Preliminary Engine Testing .....	15-1	Removing Front End (4630) .....	25-23
Engine Tune-Up .....	15-1	Separating Clutch Housing from	
Operation .....	15-8	Power Shift Transmission Case .....	25-26
General .....	15-8	Separating Clutch Housing from	
GROUP 20—LUBRICATION		Quad-Range Transmission Case .....	25-28
Lubricants .....	20-1	Removing Rear Axle Housing .....	25-30
Engine .....	20-2	GROUP 30—SPECIFICATIONS .....	30-1
Transmission-Hydraulic System .....	20-3		
Front Wheel Bearings .....	20-6		
Grease Fittings .....	20-6		

## Group 5 GENERAL TRACTOR SPECIFICATIONS

#### HORSEPOWER:\*

4430 .....	125.88 hp ( 93.87 kW)
4630 .....	150.66 hp (112.43 kW)

#### ENGINE:

Type .....	6-cylinder, in-line, valve-in-head, diesel, turbocharged
Bore and stroke .....	4-1/4 x 4-3/4 in. (108 x 121 mm)
Displacement .....	404 cu. in. (6620 cm <sup>3</sup> )
Compression ratio .....	15.5 to 1
Firing order .....	1-5-3-6-2-4
Valve clearance .....	In.-0.018 in. (0.46 mm) Ex.-0.028 in. (0.71 mm)
Injection pump timing .....	TDC
Engine Speeds:	
Working range .....	1500 to 2200 rpm
Maximum transport speed .....	2400 rpm
Engine speeds:	
Slow idle .....	800 rpm
Fast idle .....	2400 rpm

\*Official test: hp. measured at the PTO at 2200 engine rpm.

LUBRICATION SYSTEM:..... Full pressurized  
 with full-flow micronic oil  
 filter, water cooled oil  
 cooler, and bypass valves  
 for filter and cooler.

#### FUEL SYSTEM:

Type .....	Diesel, direct injection
Filter .....	Two-stage with replaceable impregnated paper element.
Injection pump type .....	Multiple plunger, in-line
Air cleaner .....	Dry type, with safety element

#### COOLING SYSTEM:

Type .....	Pressurized with centrifugal pump
Temperature control .....	Heavy-duty thermostats

**CAPACITIES**

- Fuel Tank
  - 4430 ..... 46 U.S. gals. (175 l)
  - 4630 ..... 65 U.S. gals. (245 l)
  
- Cooling system\*
  - 4430 ..... 30 U.S. qts. (28 l)
  - 4630 ..... 36 U.S. qts. (34 l)
- \*Add 2 qts. (2 l) if equipped with Sound-Gard Body heater.
- Engine crankcase (includes filter change) ..... 17 U.S. qts. (16 l)
- Transmission-hydraulic system—drain and fill\*\*
  - 4430 Syncro-Range ..... 11 U.S. gals. (42 l)
  - 4430 Quad-Range ..... 11 U.S. gals. (42 l)
  - 4430 Power Shift ..... 10 U.S. gals. (38 l)
  - 4630 Syncro-Range ..... 21 U.S. Gals. (80 l)
  - 4630 Quad-Range ..... 21 U.S. Gals. (80 l)
  - 4630 Power Shift ..... 12 U.S. Gals. (46 l)
- \*\*Add 3 to 6 gals. if transmission is disassembled and all oil removed. Add 5 gals. (19 l) if equipped with power front-wheel drive.
- Hi-Crop final drive (each side) ... 2 U.S. qts. (2 l)

**SYNCRO-RANGE TRANSMISSION:**

- Type ..... Syncro-range, constant mesh
- Perma-Clutch ..... Hydraulically operated, wet clutch, multiple disk
- Gear selections ..... 8 forward and 2 reverse
- Shifting ..... 4 stations, synchronized forward speed shifting within stations

**QUAD-RANGE TRANSMISSION:**

- Type ..... 2-speed, power shifted, planetary and 8-speed, syncro-range transmission with constant mesh gears
- Perma-Clutch ..... Hydraulically operated multiple disk wet clutch
- Gear selections ..... 16 forward and 6 reverse
- Shifting
  - Range selector lever ..... Collar shifted between ranges
  - Speed selector lever
    - Forward-rearward lever movement
      - Mechanically synchronized forward speed shifting of syncro-range transmission
    - Sideways lever movement ..... Power shifted planetary transmission speeds

**POWER SHIFT TRANSMISSION:**

- Type ..... Planetary gears, hydraulically actuated wet disk clutches and brakes
- Gear selections ..... 8 forward and 4 reverse
- Shifting ..... Hydraulic, powershifting controlled by speed selector

**POWER TAKE-OFF**

- Type ..... Independent PTO with rear power take-off controlled by hand-operated clutch lever stub shafts used for dual speed PTO speed conversion
- Speed (2200 engine rpm) ..... Dual speed—540 or 1000 rpm; single speed—1000 rpm
- PTO ahead of drawbar
  - hitch point ..... 540 rpm—14 in. (356 mm)
  - 1000 rpm—16 in. (406 mm)

**ELECTRICAL SYSTEM**

- Type ..... 12-volt, negative grounded
- Batteries:
  - Diesel ..... Two, 6-volt, 5D group, 800 amps cold cranking at 0°F (-18°C) 376 minutes reserve capacity at 25 amps
- Alternator ..... 12-volt, 55 amp with Sound-Gard body, 37 amp without Sound-Gard body

**POWER FRONT-WHEEL DRIVE**

- Type ..... Hydraulic motor driven with planetary gear reduction in wheel hub, uses pressure oil from hydraulic system
- Torque ..... Low (series connected) and high (parallel connected)
- Controls ..... Solenoid-operated control valves, synchronized with transmission controls

**HYDRAULIC SYSTEM**

- Type ..... Closed center, constant pressure
- Actuates power steering, power brakes, power front-wheel drive, and implement control
- Standby pressure ..... 2250 psi (155 bar)

**BRAKES**

- Type ..... Hydraulically actuated power disk-type operating in oil

**STEERING**

- Type ..... Hydraulically actuated power, manual operation in case of hydraulic failure

**TIRES AND TREADS** ..... See page 10-6.

**GROUND SPEEDS**

Approximate ground speeds are given in the following charts. Speeds are shown in miles per hour, with kilometers per hour in parentheses.

Speeds are for a 4430 Tractor with 20.8-34 tires or a 4630 Tractor with 20.8-38 tires.

**SYNCRO-RANGE TRANSMISSION GROUND SPEEDS**

Gear	1500 Engine rpm	2200 Engine rpm
1st	1.3 (2.1)	2.0 (3.2)
2nd	2.1 (3.4)	3.1 (5.0)
3rd	2.8 (4.5)	4.1 (6.6)
4th	3.6 (5.8)	5.3 (8.5)
5th	4.5 (7.2)	6.6 (10.6)
6th	5.9 (9.5)	8.7 (14.0)
7th	7.7 (12.4)	11.2 (18.0)
8th	12.5 (20.1)	18.3 (29.5)
1st rev.	2.7 (4.3)	4.0 (6.4)
2nd rev.	4.4 (7.1)	6.4 (10.3)

With optional Creeper engaged:

1st	0.3 (0.5)	0.4 (0.6)
2nd	0.5 (0.8)	0.7 (1.1)
3rd	0.6 (1.0)	0.9 (1.4)
4th	0.8 (1.3)	1.1 (1.8)
5th	1.0 (1.6)	1.4 (2.3)
1st reverse	0.6 (1.0)	0.8 (1.3)
2nd reverse	0.9 (1.4)	1.3 (2.1)

**POWER SHIFT TRANSMISSION GROUND SPEEDS**

Gear	1500 Engine RPM	2200 Engine RPM
1st	1.2 (1.9)	1.7 (2.7)
2nd	1.7 (2.7)	2.5 (4.0)
3rd	2.6 (4.2)	3.8 (6.1)
4th	3.4 (5.5)	5.0 (8.0)
5th	4.4 (7.1)	6.5 (10.5)
6th	5.8 (9.3)	8.5 (13.7)
7th	7.4 (11.9)	10.9 (17.5)
8th	12.6 (20.3)	18.5 (29.8)
1st rev.	1.4 (2.3)	2.1 (3.4)
2nd rev.	2.0 (3.2)	3.0 (4.8)
3rd rev.	3.2 (5.1)	4.7 (7.6)
4th rev.	4.2 (6.8)	6.1 (9.8)

**QUAD-RANGE TRANSMISSION GROUND SPEEDS**

Range	Speed	1500 Engine RPM	2200 Engine RPM
A	1	1.4 (2.3)	2.0 (3.2)
	2	1.7 (2.7)	2.5 (4.0)
	3	2.2 (3.5)	3.3 (5.3)
	4	2.8 (4.5)	4.1 (6.6)
	1R	2.2 (3.5)	3.2 (5.1)
	2R	2.7 (4.3)	4.0 (6.4)
B	1	3.1 (5.0)	4.6 (7.4)
	2	4.0 (6.4)	5.8 (9.3)
	3	5.1 (8.2)	7.5 (12.1)
	4	6.5 (10.5)	9.6 (15.4)
	1R	5.0 (8.0)	7.3 (11.7)
	2R	6.3 (10.1)	9.3 (15.0)
C	1	3.7 (6.0)	5.4 (8.7)
	2	4.7 (7.6)	6.8 (10.9)
	3	6.0 (9.7)	8.8 (14.2)
	4	7.7 (12.4)	11.2 (18.0)
	1R	5.9 (9.5)	8.6 (13.8)
	2R	7.5 (12.1)	10.9 (17.5)
D	1	5.7 (9.2)	8.3 (13.4)
	2	7.2 (11.6)	10.5 (16.9)
	3	9.3 (15.0)	13.6 (21.9)
	4	11.8 (19.0)	17.3 (27.8)

**DIMENSIONS (4430):**

	Tractor without Roll-Gard*	Tractor with Sound-Gard Body*
Wheel base	106-5/8 in. (2 710 mm)	106-5/8 in. (2 710 mm)
Over-all length	160-3/4 in. (4 080 mm)	160-3/4 in. (4 080 mm)
Height to muffler cover	109-5/16 in. (2 770 mm)	125-1/4 in. (3 180 mm)
Height to steering wheel	85-1/4 in. (2 160 mm)	---
Height to top of Sound-Gard Body	---	114 in. (2 900 mm)
Over-all width (regular axle)	89-5/8 in. (2 280 mm)	89-5/8 in. (2 280 mm)
Width at fender	70-7/8 in. (1 800 mm)	82 in. (2 080 mm)
Width at roof	----	54-3/8 in. (1 380 mm)
Turning radius	147 in. (3.73 m)	147 in. (3.73 m)

\*Tractor equipped with 18.4-38 R-1 rear tires and 10.00-16 front tires.

DIMENSIONS (4630):

	Tractor without Roll-Gard*	Tractor with Sound-Gard Body*
Wheel base .....	112-5/8 in. (2.86 m)	112-5/8 in. (2.86 m)
Overall length .....	171-1/4 in. (4.35 m)	171-1/4 in. (4.35 m)
Height to muffler cover .....	110-1/8 in. (2.80 m)	127-5/8 in. (3.24 m)
Height to steering wheel .....	89-3/8 in. (2.27 m)	---
Height to top of Sound-Gard Body .....	---	118-1/8 in. (3.00 m)
Overall width (regular axle) ..	95-7/8 in. (2.44 m)	95-7/8 in. (2.44 m)
Width at roof .....	----	54-3/8 in. (1.38 m)
Width at fenders .....	70-7/8 in. (1.80 m)	82 in. (2.08 m)
Turning radius .....	158 in. (4.01 m)	158 in. (4.01 m)

SHIPPING WEIGHT\*\*

	Tractor without Roll-Gard	Tractor with Sound-Gard Body
4430 .....	9,732 lbs. (4415 kg)	10,762 lbs. (4880 kg)
4630 .....	12,465 lbs. (5654 kg)	13,365 lbs. (6062 kg)

\*\*With equipment for average field service, less fuel and ballast. Add 375 lbs. (170 kg) if equipped with a Power Shift transmission. Add 125 lbs. (57 kg) if equipped with a Quad-Range transmission. Add 450 lbs. (204 kg) if equipped with a 4-post Roll-Gard. Add approximately 1000 lbs. (454 kg) if equipped with a Power Front-Wheel Drive.

ADDITIONAL SPECIFICATIONS:

For additional specifications, refer to the section of this manual which covers that particular part of the tractor.

\*Tractor equipped with 20.8-38 rear tires and 10.00-16 front tires.

(Specifications and design subject to change without notice.)

## Group 10 PREDELIVERY, DELIVERY, AND AFTER-SALE SERVICES

The John Deere Delivery Receipt, when properly filled out and signed by the dealer and customer, verifies that the predelivery and delivery services were satisfactorily performed. When delivering this machine, give the customer his copy of the delivery receipt and the operator's manual. Explain their purpose to him.

Because of the shipping factors involved, plus extra finishing touches that are necessary to promote customer satisfaction, proper predelivery service is of prime importance to the dealer.

A tag pointing out the factory-recommended procedure for predelivery service is attached to each new tractor before it leaves the factory.

After completing the factory-recommended dealer checks and services listed on the predelivery tag, remove the tag from the tractor and file it with the shop order for the job. The tag will certify that the tractor has received the proper predelivery service when that portion of the customer's John Deere Delivery Receipt is completed.

### BEFORE UNLOADING TRACTOR

Before starting tractor to unload it, make a few quick checks to be sure it is in good operating condition.

### Checking Engine Oil Level

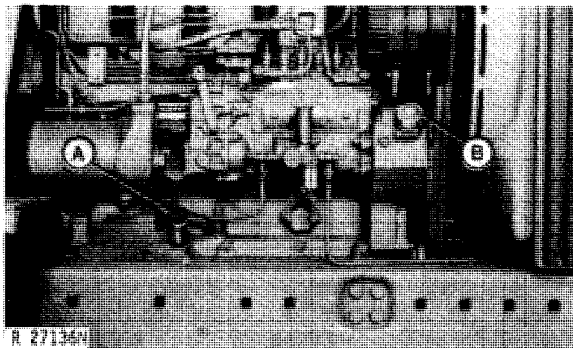

A—Dipstick

B—Filler Cap

Fig. 1-Engine Oil Dipstick and Filler Cap

Loosen and remove engine oil dipstick (A, Fig. 1). Observe oil level. If necessary, add sufficient oil to bring oil level to full mark on dipstick. Use John Deere Torq-Gard Supreme SAE 10W-20 or its equivalent.

*NOTE: Tractor should be on a level surface when oil level is checked. If it is not, check only to make sure the crankcase is not dry. Recheck oil level later, when tractor is on level ground.*

### Checking Coolant Level

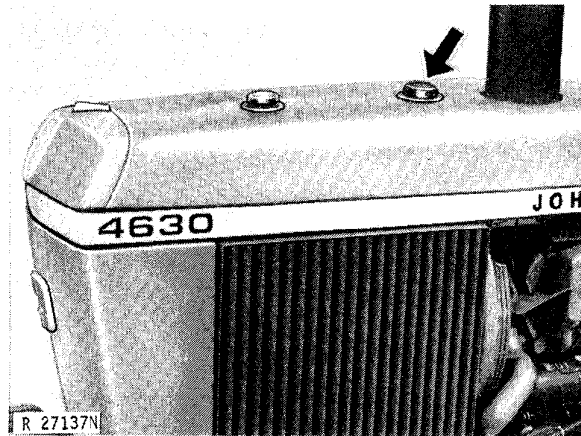
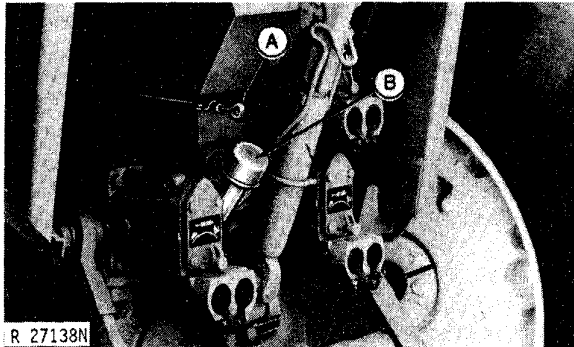

Fig. 2-Radiator Filler Cap

Remove radiator filler cap and check coolant level. Coolant should be at least 1-1/2 inches (38 mm) above baffle in radiator top tank. If necessary, add coolant to obtain this level. Use permanent type, ethylene glycol antifreeze which contains a rust inhibitor but does not contain a stop-leak additive.

### Checking Transmission-Hydraulic System Oil Level



A—Dipstick                      B—Filler Cap

Fig. 3-Transmission-Hydraulic System Dipstick

Remove transmission-hydraulic system dipstick (A, Fig. 3) and observe oil level on dipstick. If necessary, add sufficient oil to bring level to full mark on dipstick. Use John Deere Hy-Gard Transmission and Hydraulic Oil or its equivalent.

*NOTE: Tractor should be on a level surface when oil level is checked. If it is not, check only to make sure the system is not dry. Recheck oil level later, when tractor is on level ground.*

### Reducing Tire Pressure

Tires are overinflated for shipping. To avoid risk of tire damage, reduce inflation pressure before driving tractor.

### Front Tires

Tire Size	Ply Rating	Maximum Pressure
7.5L-15	6	44 psi (3.0 bar) (3.0 kg/cm <sup>2</sup> )
7.50-18	6	44 psi (3.0 bar) (3.0 kg/cm <sup>2</sup> )
7.50-20	6	44 psi (3.0 bar) (3.0 kg/cm <sup>2</sup> )
9.50-20	8	44 psi (3.0 bar) (3.0 kg/cm <sup>2</sup> )
10.00-16	6	32 psi (2.2 bar) (2.2 kg/cm <sup>2</sup> )
11L-15	6	32 psi (2.2 bar) (2.2 kg/cm <sup>2</sup> )
11.00-16	8	40 psi (2.8 bar) (2.8 kg/cm <sup>2</sup> )
12.4-24	6	24 psi (1.7 bar) (1.7 kg/cm <sup>2</sup> )
14L-16.1	6	28 psi (1.9 bar) (1.9 kg/cm <sup>2</sup> )
14.9-24	6	20 psi (1.4 bar) (1.4 kg/cm <sup>2</sup> )

### Rear Tires

Tire Size	Ply Rating	Maximum Pressure
12.4-42	6	12 psi (0.8 bar) (0.8 kg/cm <sup>2</sup> )
15.5-38	6	20 psi (1.4 bar) (1.4 kg/cm <sup>2</sup> )
15.5-38	8	26 psi (1.8 bar) (1.8 kg/cm <sup>2</sup> )
16.9-38	8	24 psi (1.7 bar) (1.7 kg/cm <sup>2</sup> )
18.4-34	6	16 psi (1.1 bar) (1.1 kg/cm <sup>2</sup> )
18.4-34	8	20 psi (1.4 bar) (1.4 kg/cm <sup>2</sup> )
18.4-38	6	16 psi (1.1 bar) (1.1 kg/cm <sup>2</sup> )
18.4-38	8	20 psi (1.4 bar) (1.4 kg/cm <sup>2</sup> )
18.4-38	10	26 psi (1.8 bar) (1.8 kg/cm <sup>2</sup> )
20.8-34	6	18 psi (1.2 bar) (1.2 kg/cm <sup>2</sup> )
20.8-34	8	18 psi (1.2 bar) (1.2 kg/cm <sup>2</sup> )
20.8-38	8	18 psi (1.2 bar) (1.2 kg/cm <sup>2</sup> )
20.8-38	10	22 psi (1.5 bar) (1.5 kg/cm <sup>2</sup> )
23.1-30	8	16 psi (1.1 bar) (1.1 kg/cm <sup>2</sup> )
23.1-34	8	16 psi (1.1 bar) (1.1 kg/cm <sup>2</sup> )
24.5-32	10	20 psi (1.4 bar) (1.4 kg/cm <sup>2</sup> )

### Inspecting Tractor

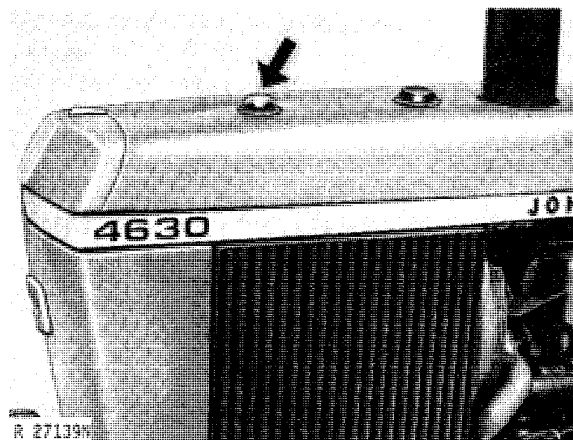

Fig. 4-Fuel Tank Filler Cap

1. Check fuel tank to be sure tractor has enough fuel for unloading and driving around the lot. If not, add a little fuel. Try to never run a diesel engine out of fuel.
2. Inspect tractor for any damage in transit. Notify carrier immediately if you find any.
3. At the same time, check for any oil leaks, missing parts, or obvious defects. Notify your service manager if you find any.

## Unloading Tractor

*NOTE: Muffler outlet is plugged before shipment, to prevent wind from turning turbocharger and possibly damaging bearings. Remove plug before starting engine.*

1. Remove tie downs and blocking. See that there are no obstructions in the way.
2. Be sure transmission is in park. Push engine stop knob in, and position hand throttle approximately 1/3 of the way forward.
3. Turn key switch all the way clockwise to start engine. Release key as soon as engine starts. Run engine at approximately 1000 rpm.

Do not operate starter more than 30 seconds at a time, to prevent overheating starter. Wait at least two minutes between attempts.

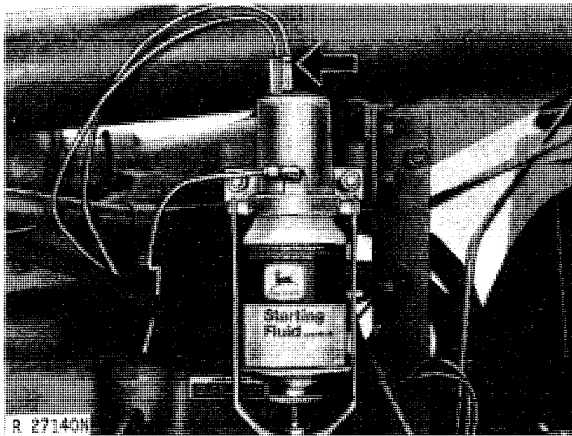

Fig. 5-Electric Starting Aid Connector

*NOTE: Electric starting aid is not connected. If necessary, attach connector to solenoid.*

4. After engine starts, make sure engine oil pressure gauge rises to the green band. If it does not, stop engine immediately and determine the cause.
5. Check brakes before moving tractor. Pedal travel should not exceed three inches (80 mm).
6. With transmission in lowest gear, carefully drive tractor onto level ground.

## TRACTOR STORAGE

To prevent deterioration of tractor during storage, spend a few minutes properly preparing it.

### Short-Term (Under 30 Days)

1. Fill fuel tank. This prevents condensation of moisture in tank.
2. Check engine oil level, transmission-hydraulic oil level, and coolant level. Add oil or coolant if necessary. During cold weather, be sure coolant contains sufficient anti-freeze.
3. Check electrolyte level in batteries. If electrolyte does not cover plates, add distilled water. Make sure batteries are fully charged.
4. Store tractor in a dry, protected place. If necessary to store tractor outside, cover it with a protective material. Protect tires from heat, sunlight, and petroleum products.

### Long-Term (Over 30 Days)

1. If tractor is to be stored longer than 30 days, use an AR41785 Engine Storage Kit and an extra can of AR41870 Internal Corrosion Inhibitor. Follow instructions in kit, except do not change engine oil, replace filters, or drain and flush cooling system on a new tractor.
2. Loosen fan belts and air conditioning compressor belt.
3. Clean the tractor. Touch up any painted surfaces which are scratched or chipped.
4. Coat exposed metal surfaces, such as axles and piston rods of hydraulic cylinders, with grease or corrosion preventative.
5. Store tractor in a dry, protected place. If necessary to store tractor outside, cover it with a protective material. Protect tires from heat, sunlight, and petroleum products.
6. When removing tractor from storage, remove protective cover and unseal all openings. Check engine oil level, transmission-hydraulic system oil level, coolant level, and tire inflation pressure. Install batteries. Adjust belt tension. Fill fuel tank. Perform 600-hour service. Hold engine stop knob out and crank engine until oil pressure builds up before starting engine. (Do not crank engine longer than 30 seconds. Wait at least two minutes for starter to cool before trying again.)

## PREDELIVERY SERVICE

### ELECTRICAL SYSTEM

#### Batteries

1. Check battery terminals and battery cable ends. If they are corroded, clean and coat them with a mixture of petroleum jelly and baking soda.

2. Check electrolyte level in each battery cell. Add distilled water if necessary to bring level above cell plates.

3. If batteries are not fully charged, charge them. Connect charger to positive cable to starter and to tractor frame. If using a fast charging rate, loosen cap on each cell while charging.

#### Belt Tension

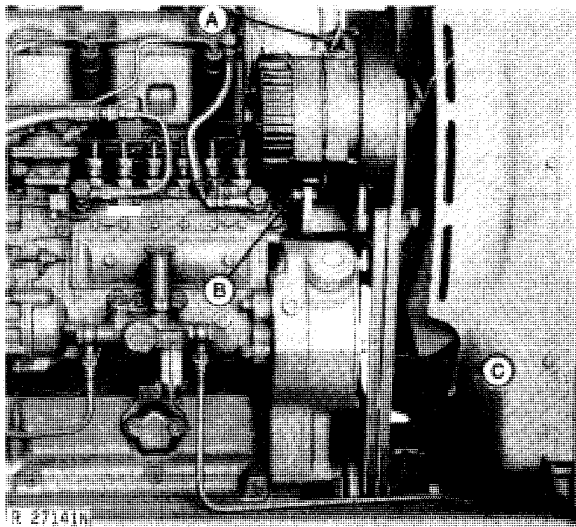

A—Adjusting Cap Screw      C—1" (25 mm) Flex  
B—Mounting Bolt

Fig. 6—Adjusting Fan Belt Tension

Check tension of fan belts and air conditioning compressor belt. Adjust if necessary. Fan belts should deflect one inch (25 mm) when a 25-pound (110 N) force is applied midway between pulleys.

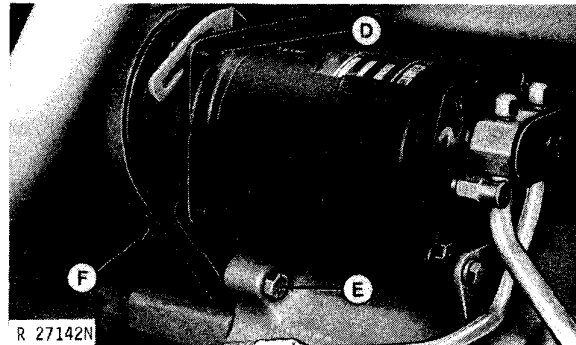

D—Adjusting Cap Screw      F—1/4" (6 mm) Flex  
E—Mounting Bolt

Fig. 7—Adjusting Compressor Belt Tension

Compressor belt should deflect one-fourth inch (6 mm) when a 15-pound (65 N) force is applied midway between pulleys.

#### Lighting

1. Install light switch knob.
2. See that all lights work properly.

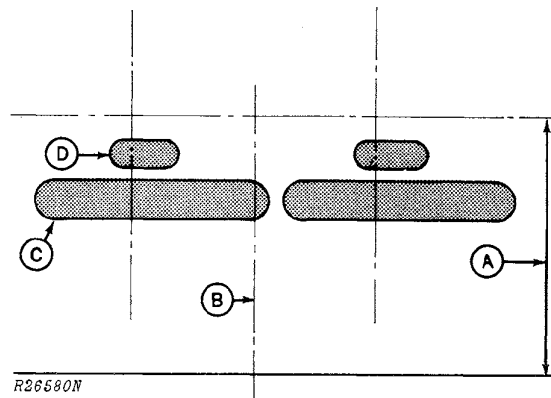

A—Height of Lamp      C—Lower Light Zone  
B—Centerline of Tractor      D—Upper Light Zone

Fig. 8—Light Pattern at 25 ft. (8 m)

3. Check headlight adjustment. Direct headlight beams slightly downward and to the right. See that no lights will blind the operators of other vehicles.

4. If flashing lights are prohibited by local regulations, see that warning lamps are prepared for non-flashing operation. On tractors with turn signals, use AR67398 Turn Signal Controller. On tractors without turn signals, disconnect flasher in electrical load center and install AR41694 Wiring Lead at connector.

### Starting Aid

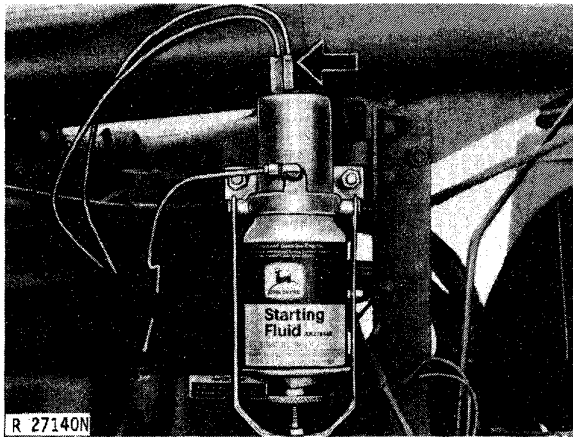

Fig. 9-Electric Starting Aid Connector

Tractors are shipped with electric starting aid disconnected. Before delivering tractor, attach connector to solenoid.

### Power Front-Wheel Drive

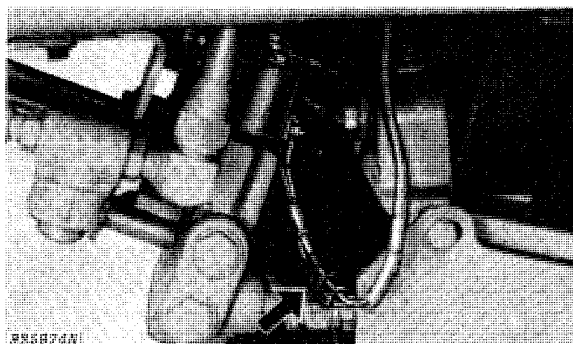

Fig. 10-Power Front-Wheel Drive Connector

Tractors with power front-wheel drive are shipped with solenoids disconnected. Before delivering tractor, connect wiring harness to solenoids.

## COOLING SYSTEM

### Coolant Level

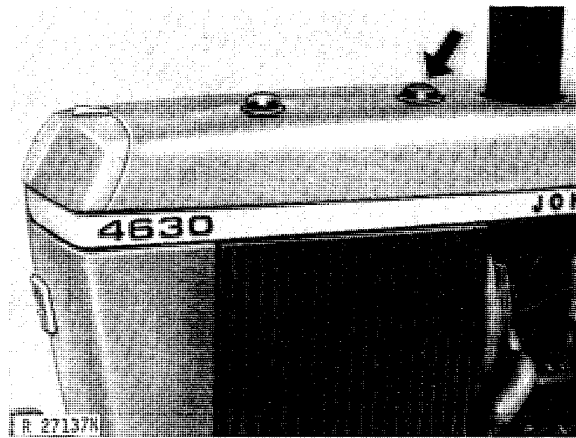

Fig. 11-Radiator Cap

Remove radiator cap and check coolant level. Level should be at least 1-1/2 inches (38 mm) above baffle in radiator top tank. If coolant is low, fill to proper level and try to determine why coolant was lost.

### Anti-Freeze Protection

Use a dependable, temperature-correcting hydrometer to check anti-freeze protection of coolant. If more is needed, use permanent type, ethylene glycol anti-freeze which contains a rust inhibitor but does not contain a stop-leak additive.

### Leaks

Check entire cooling system—radiator, heater, engine oil cooler, intercooler, and all connecting pipes and hoses—for any sign of leaks. Tighten clamps on radiator hoses and heater hoses.

## TIRES, WHEELS, AND WEIGHTS

### Adjusting Front Tread Width

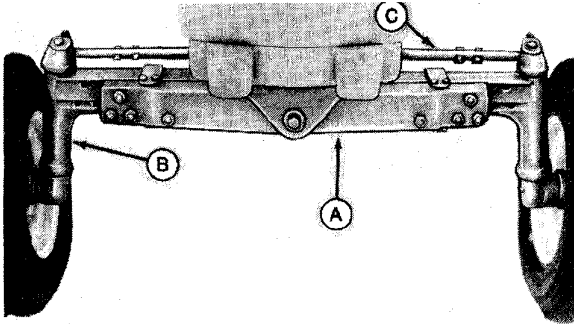

R 27143N

A—Front Axle  
B—Knee

C—Tie Rod

Fig. 12-Front Axle

Adjust front tread width to customer's needs.

1. Jack up front end of tractor.

**IMPORTANT:** Do not place jack under engine oil pan or, on Power Front-Wheel Drive tractor, under the hose guard at front axle.

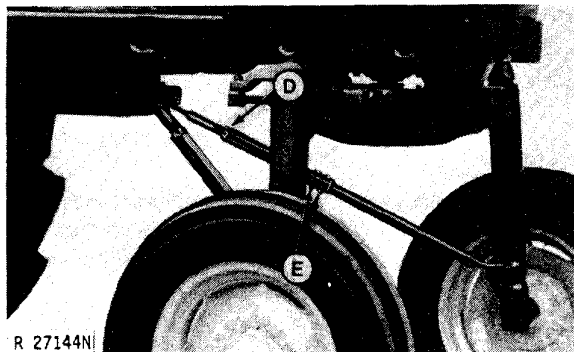

R 27144N

D—Slotted Nut

E—Lock Bolts

Fig. 13-Hi-Crop Radius Rods

2. On Hi-Crop tractors, loosen the slotted nuts on radius rods away from couplings and remove radius rod coupling lock bolts.

3. Remove bolts from front axle and from tie rods. Move the front axle knees out to desired tread width.

4. Reinstall bolts. Tighten axle-to-knee bolts to 370 ft-lbs (500 Nm) (50 kgm) on all 4430 Tractors except Hi-Crop. Tighten to 445 ft-lbs (600 Nm) (60 kgm) on Hi-Crop and 4630 Tractors.

5. On Hi-Crop tractors, adjust radius rod couplings so that lock bolt holes are aligned. Install lock bolts and tighten slotted nuts. Exposed threads on radius rods must never exceed 1-3/8 inches (35 mm).

6. On Power Front-Wheel Drive tractors, make sure small bleed hoses are not pinched or kinked.

7. Check toe-in each time front tread is changed. See the following instructions.

### Checking Toe-In

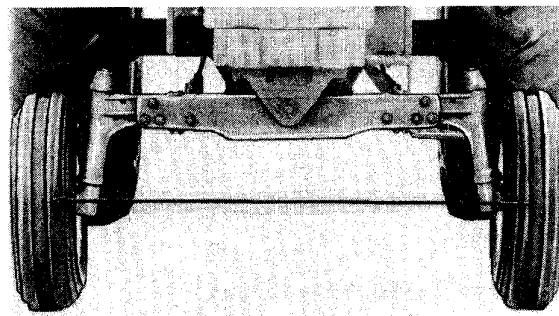

R 27145N

Fig. 14-1/8 to 3/8 in. (3 to 9 mm) Toe-In

To check toe-in, steer front wheels straight ahead and measure distance from tire to tire, first at front of tires and then at rear. Front measurement should be 1/8 to 3/8 inch (3 to 9 mm) less than rear.

If toe-in adjustment is needed, remove bolts from tie rod tubes and loosen clamps on inner ends of tie rods. Turn tie rod tubes in or out until toe-in is correct. Replace bolts and tighten clamps.

Tie rods should be adjusted to equal length, so tractor will turn equally sharp in either direction.

## Adjusting Rear Tread Width

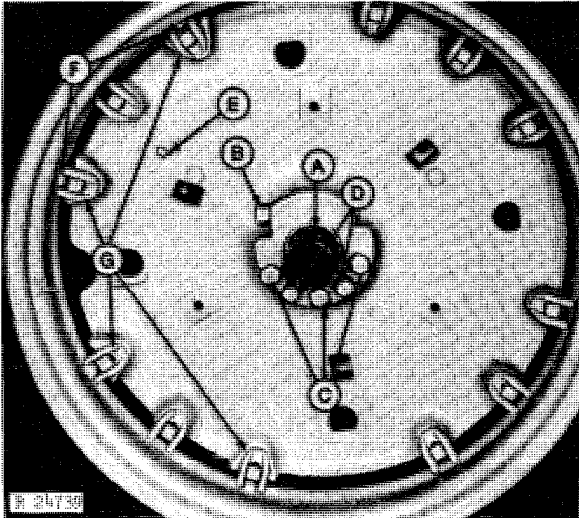

A—Rack  
B—Pinion  
C—Special Bolts  
D—Jack Screws  
E—Weight Reference Mark  
F—Rim Driving Lugs  
G—Wheel Driving Lugs

Fig. 15-Rack and Pinion Wheel

Adjust rear tread width to customer's needs.

**CAUTION:** Unless tractor is equipped with double rear wheels, tread width must be at least 60 inches (1.52 m) for tractor stability.

1. Jack up tractor. Rotate wheel so that rack is on top of axle.
2. If needed, clean axle with a steel brush.
3. Loosen the three special bolts (C, Fig. 15) approximately 3/8 inch (10 mm) each.
4. Tighten the two jack screws (D) evenly until key sleeve loosens.

*NOTE: If sleeve is difficult to break loose, also loosen the three special bolts on inboard side of wheel. If sleeve still will not break loose, strike end of axle several times with a heavy hammer and evenly retighten jack screws. It helps to soak sleeves with penetrating oil.*

5. Turn pinion (B) to slide wheel in or out on axle to desired position. For extreme tread positions, it may be necessary to reverse wheel on axle or change rim position on wheel.

**IMPORTANT:** Tires or weights must have at least one inch (25 mm) clearance with fenders. To prevent damaging pinion when hub is tightened, do not put wheel in its very innermost position—back it out at least 1/8 inch (3 mm).

6. Back jack screws all the way out against stop. Do not force.

7. Lubricate threads and tighten special bolts to 300 ft-lbs (410 Nm) (41 kgm). Retighten bolts several times until all three stay tightened to specified torque. Jack screws must be free to turn after hub is tightened. If necessary, loosen jack screws further and retighten special bolts.

**IMPORTANT:** After driving tractor approximately 100 yards (100 m), retighten special bolts to proper torque. Instruct customer to retighten them after 3 hours work and again after 10 hours work, and to keep them tight.

## Installing Ballast

### Rear Wheel Weights

1. See that weight reference mark (E, Fig. 15) on wheel is up, so hand holds on weights will be in horizontal position.
2. Position weights so that reference mark on weight matches reference mark on wheel. Otherwise, certain weights would not leave wrench clearance for adjusting wheel tread.
3. Install mounting bolts and tighten securely.

**IMPORTANT:** On a tractor with double wheels, ballasting the outer wheel is not recommended.

## Installing Ballast—Continued

### Single Front Weights

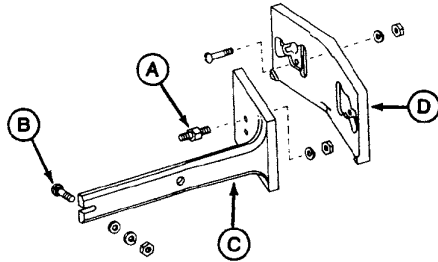

R 27146N

A—Special Screw  
B—Bolt  
C—Side Weight  
D—Single Front Weight

Fig. 16—Single Front Weights

1. Install special screws (A, Fig. 16) in upper holes in mounting pad, short end first. Tighten screws securely.
2. Install bolt (B) loosely in side frame.
3. Slide side weight (C) onto special screw and bolt. Install washers and nuts, and tighten securely.
4. After both side weights are installed, install front weights (D) one at a time. Rotate each weight 180° with respect to preceding weight to line up mounting holes. As many as eight front weights may be used.

### Double Front Weights

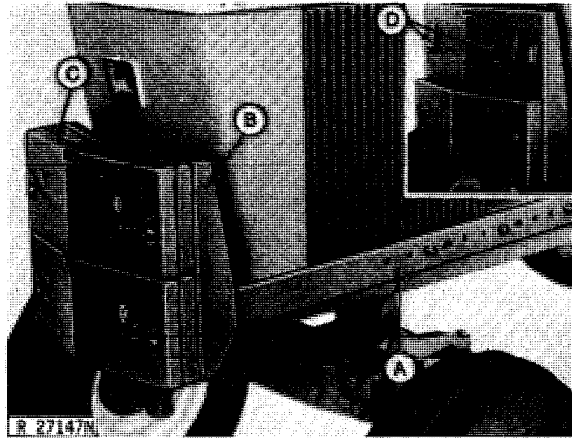

A—Weight Support  
B—Double Front Weight  
C—Single Front Weights  
D—Spring Nuts

Fig. 17—Double Front Weights

1. Install weight supports (A, Fig. 17) first. Instructions are included with mounting hardware.
2. Attach double weight (B) to weight supports, using four square-head bolts, and tighten securely.
3. Use four longest round-head bolts to attach first two single front weights. Hold bolts in position with spring washers.
4. Install additional single front weights one at a time. Rotate each weight 180° with respect to preceding weight to line up mounting holes. Two rows of up to seven single weights may be used.

### Quik-Tatch Front Weights

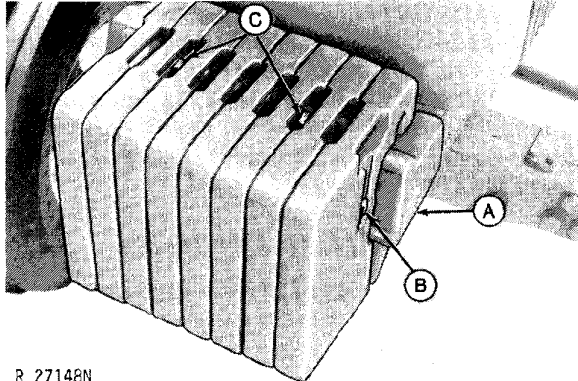

R 27148N

A—Weight Support  
B—Bolt

C—Retainers

Fig. 18-Quik-Tatch Front Weights

Up to 10 Quik-Tatch Front Weights may be installed on weight support. Complete instructions are included with mounting hardware.

If fabricated steel (rather than cast iron) weight support is used, side wings and up to four additional weights may be added.

### Liquid Ballast in Tires

Liquid ballast can be used in any tires—front or rear, tubeless or tube type.

Special equipment is required for installing fluid in tires. Follow instructions provided with equipment, and observe the following restrictions.

1. Use calcium chloride to keep water from freezing. A mixture of 3.5 pounds of calcium chloride per gallon of water (0.42 kg/l) will not freeze solid above  $-50^{\circ}\text{F}$  ( $-45^{\circ}\text{C}$ ).
2. Fill tire only to level of valve stem. This leaves 25% air space to absorb impacts.
3. On a tractor equipped with double wheels, ballasting the outer wheel is not recommended.

### Installing Double Wheels

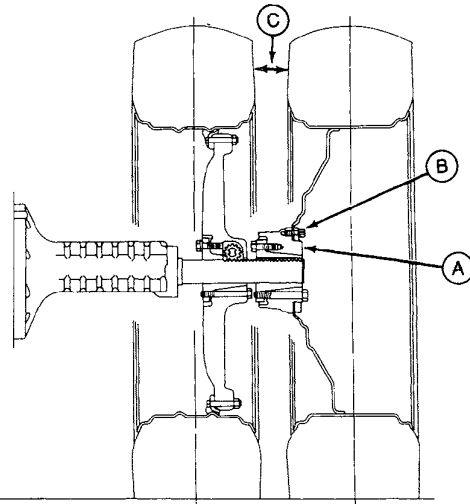

R 27149N'

A—Hub  
B—Cap Screws

C—Minimum Gap of 4 in.  
(100 mm)

Fig. 19-Double Wheels

### Hubs Installed at Factory

If hubs are already installed on axles, simply attach steel wheels to hubs. Tighten wheel retaining cap screws to 240 ft-lbs (325 Nm) (32 kgm) torque.

**IMPORTANT:** Be sure gap between tires is at least four inches (100 mm). See page 7 for tread adjustment instructions.

**IMPORTANT:** After driving tractor approximately 100 yards (100 m) retighten wheel retaining cap screws to 240 ft-lbs (325 Nm) (32 kgm) torque. Instruct customer to retighten them after 3 hours work and again after 10 hours work, and to keep them tight.

## Installing Double Wheels—Continued

### Hubs Not Installed

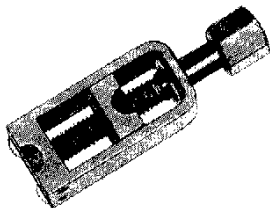

R 26708N

Fig. 20-JDG-18 Snap Ring Tool\*

\*Order from Service Tools, Box 314, Owatonna MN 55060.

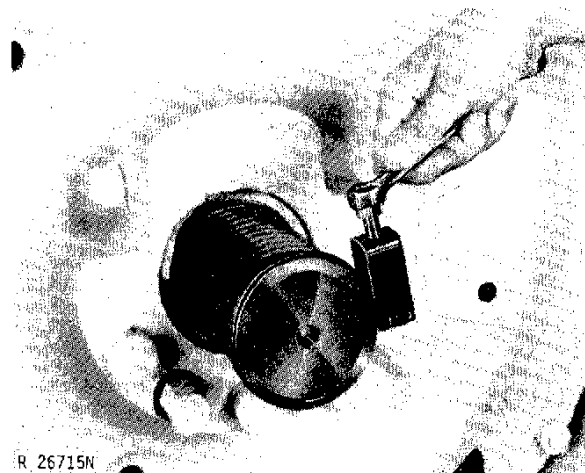

R 26715N

Fig. 21-Using JDG-18 Snap Ring Tool

1. If hubs are not installed, remove snap ring from end of axle. Use JDG-18 Snap Ring Tool as shown in Fig. 21.

2. Install wheel on axle, and adjust tread to desired position. See tread adjustment instructions on page 7.

**IMPORTANT: Be sure gap between tires is at least four inches (100 mm).**

3. Reinstall snap ring on end of axle.

4. Install other wheel in same manner.

**IMPORTANT:** After driving tractor approximately 100 yards (100 m), tighten hub special screws to 300 ft-lbs (410 Nm) (41 kgm) torque. If steel outer wheels are used, tighten wheel retaining cap screws to 240 ft-lbs (325 Nm) (32 kgm) torque. Instruct customer to retighten them after 3 hours work and again after 10 hours work, and to keep them tight.

## Checking Tire Inflation Pressure

Check inflation pressure of all tires before delivering tractor. Adjust pressure to the maximums listed below. The customer can then easily reduce pressure slightly if necessary, depending on how tractor is used.

### Front Tires

Tire Size	Ply Rating	Maximum Pressure
7.5L-15	6	44 psi (3.0 bar) (3.0 kg/cm <sup>2</sup> )
7.50-18	6	44 psi (3.0 bar) (3.0 kg/cm <sup>2</sup> )
7.50-20	6	44 psi (3.0 bar) (3.0 kg/cm <sup>2</sup> )
9.50-20	8	44 psi (3.0 bar) (3.0 kg/cm <sup>2</sup> )
10.00-16	6	32 psi (2.2 bar) (2.2 kg/cm <sup>2</sup> )
11L-15	6	32 psi (2.2 bar) (2.2 kg/cm <sup>2</sup> )
11.00-16	8	40 psi (2.8 bar) (2.8 kg/cm <sup>2</sup> )
12.4-24	6	24 psi (1.7 bar) (1.7 kg/cm <sup>2</sup> )
14L-16.1	6	28 psi (1.9 bar) (1.9 kg/cm <sup>2</sup> )
14.9-24	6	20 psi (1.4 bar) (1.4 kg/cm <sup>2</sup> )

### Rear Tires

Tire Size	Ply Rating	Maximum Pressure
12.4-42	6	12 psi (0.8 bar) (0.8 kg/cm <sup>2</sup> )
15.5-38	6	20 psi (1.4 bar) (1.4 kg/cm <sup>2</sup> )
15.5-38	8	26 psi (1.8 bar) (1.8 kg/cm <sup>2</sup> )
16.9-38	8	24 psi (1.7 bar) (1.7 kg/cm <sup>2</sup> )
18.4-34	6	16 psi (1.1 bar) (1.1 kg/cm <sup>2</sup> )
18.4-34	8	20 psi (1.4 bar) (1.4 kg/cm <sup>2</sup> )
18.4-38	6	16 psi (1.1 bar) (1.1 kg/cm <sup>2</sup> )
18.4-38	8	20 psi (1.4 bar) (1.4 kg/cm <sup>2</sup> )
18.4-38	10	26 psi (1.8 bar) (1.8 kg/cm <sup>2</sup> )
20.8-34	6	18 psi (1.2 bar) (1.2 kg/cm <sup>2</sup> )
20.8-34	8	18 psi (1.2 bar) (1.2 kg/cm <sup>2</sup> )
20.8-38	8	18 psi (1.2 bar) (1.2 kg/cm <sup>2</sup> )
20.8-38	10	22 psi (1.5 bar) (1.5 kg/cm <sup>2</sup> )
23.1-30	8	16 psi (1.1 bar) (1.1 kg/cm <sup>2</sup> )
23.1-34	8	16 psi (1.1 bar) (1.1 kg/cm <sup>2</sup> )
24.5-32	10	20 psi (1.4 bar) (1.4 kg/cm <sup>2</sup> )

### Checking Wheel-Stop Snap Ring Installation

Make sure snap ring is installed on the outer end of each rear axle. If necessary to install a snap ring, use JDG-18 Snap Ring Tool as shown in Fig. 21.

### LUBRICATION

#### Checking Engine Oil Level

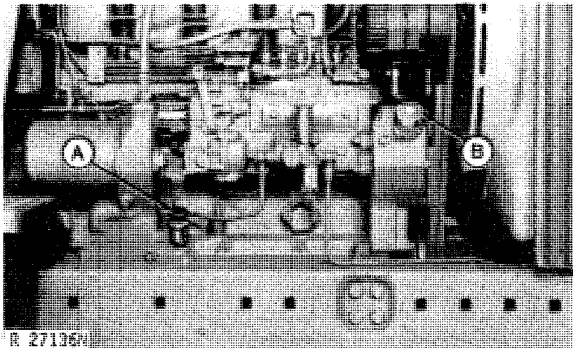

A—Dipstick B—Filler Cap

Fig. 22-Crankcase Dipstick and Filler Cap

With the tractor on level ground and the engine stopped for 10 minutes or more, loosen the dipstick and remove it. Observe the engine oil level on the dipstick, with the dipstick seated evenly. If the oil level is down to the lower marks on the dipstick, add sufficient John Deere Torq-Gard Supreme Engine Oil or its equivalent of the proper viscosity to bring the level to the upper marks.

#### Checking Transmission-Hydraulic Oil Level

With the tractor on level ground, run the engine for a minute to fill the filter. Stop the engine and check the transmission-hydraulic system oil level with the dipstick. If the oil level is down to the "ADD" mark at the bottom of the "SAFE" range on the dipstick, remove the filler cap and add John Deere Hy-Gard Transmission and Hydraulic Oil or its equivalent to bring the oil level up to the top of the "SAFE" range.

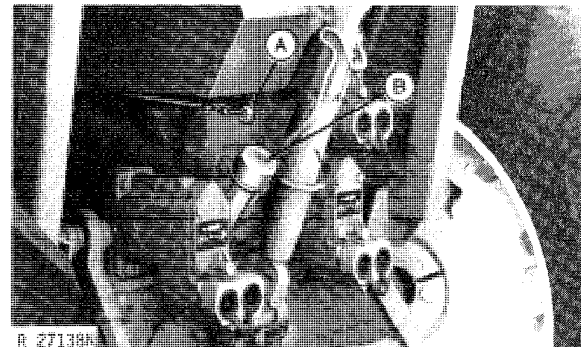

A—Dipstick B—Filler Cap

Fig. 23-Transmission-Hydraulic System Dipstick

#### Checking Hi-Crop Final Drive Oil Level

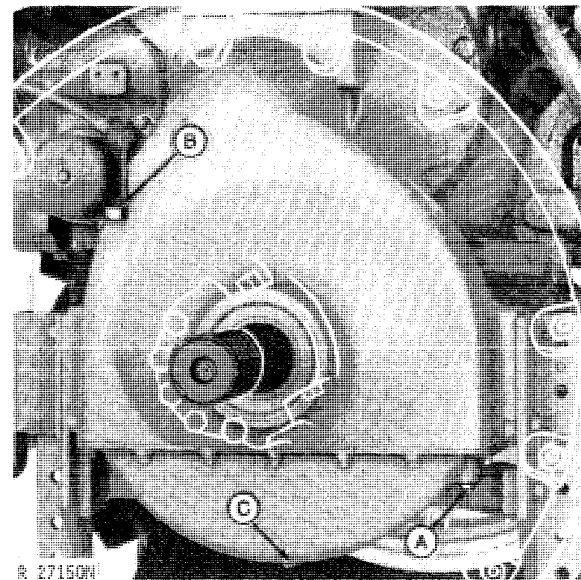

A—Oil Level Plug B—Filler Plug C—Drain Plug

Fig. 24-Hi-Crop Final Drive Housing

Remove oil level plug (A, Fig. 24) from each final drive housing and check oil level. If low, add gear lubricant at filler plug (B). Use John Deere Gear Lubricant or its equivalent. Use SAE 90 at temperatures above 32°F (0°C) and SAE 80 at temperatures below 32°F (0°C).

#### Lubricating Grease Fittings

Lubricate all grease fittings. See instructions beginning on page 20-6.

## ENGINE

### Checking Air Intake Connections

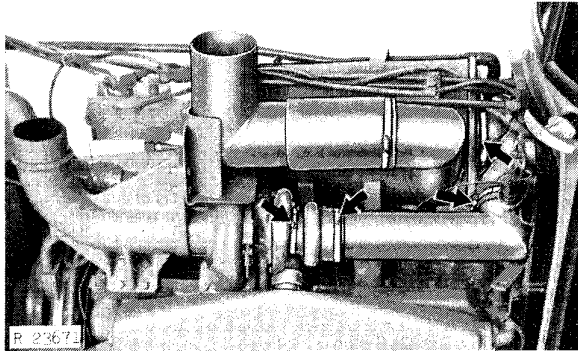

Fig. 25-Air Intake Connections (4630 Shown)

Check all connections in air intake system for possible leaks. Tighten any loose clamps. Be sure rubber dust unloading valve is on air cleaner.

### Filling Fuel Tank

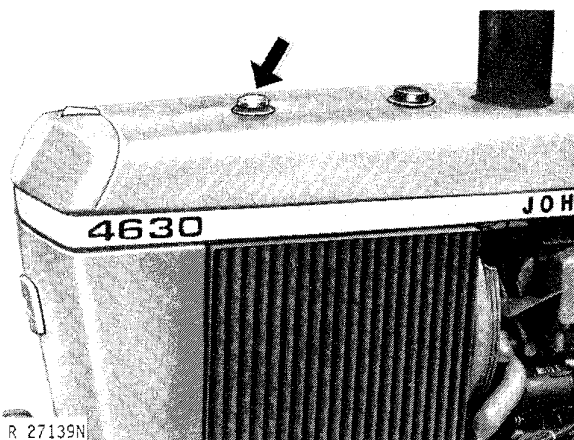
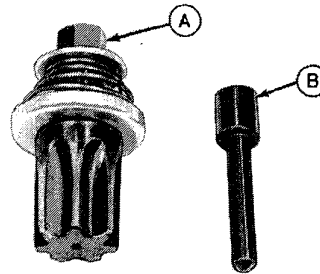

Fig. 26-Fuel Tank Filler Cap

Fill fuel tank with diesel fuel. Be sure fuel is clean, as improperly stored fuel is the cause of many engine problems. Fuel tank capacity is 46 U.S. gallons (175 l) for 4430 Tractors and 65 U.S. gallons (245 l) for 4630 Tractors.

### Checking Engine Timing



R 26134N

- A—JDE-81-1 Engine Rotation Tool\*
- B—JDE-81-4 Timing Pin\*

Fig. 27-Tools Required for Checking Timing

\*Order from Service Tools, Box 314, Owatonna, MN 55060.

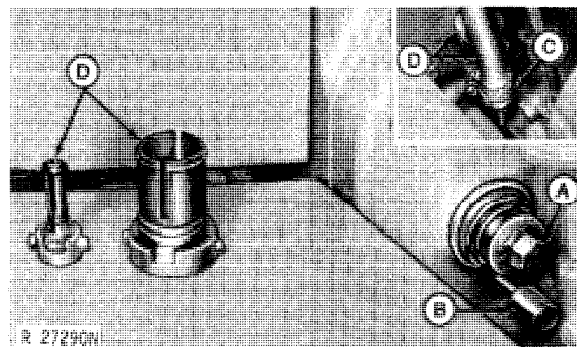

- A—Engine Rotation Tool
- B—Timing Pin
- C—Crankcase Vent Hose
- D—Plastic Plugs

Fig. 28-Installing Engine Rotation Tool and Timing Pin

1. Disconnect crankcase vent hose (C, Fig. 28). Remove plastic plugs (D), and install engine rotation tool and timing pin as shown.

2. Hold timing pin lightly against flywheel, and slowly turn engine IN DIRECTION OF NORMAL ROTATION (clockwise, as viewed from front of tractor) until pin engages hole in flywheel.

**IMPORTANT:** Normal backlash of gears is enough to throw pump timing off by several degrees, resulting in poor engine performance. To avoid backlash, always approach timing mark by turning engine in direction of normal rotation.

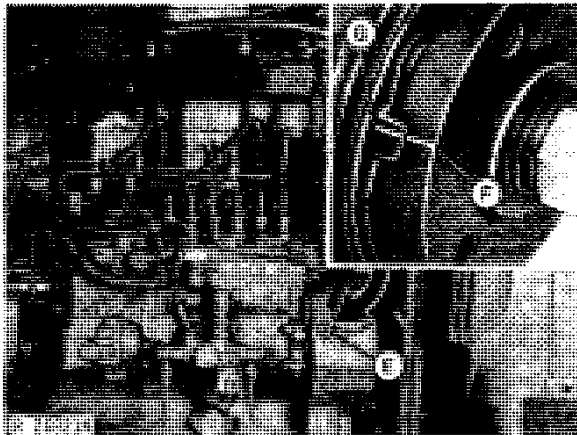

E—Timing Hole Plug      G—Pointer Mark  
 F—Drive Hub Mark

Fig. 29—Injection Pump Timing Marks

3. Remove timing hole plug (E, Fig. 29). See if timing marks are aligned.

4. If drive hub timing mark is not visible, number one piston is at top of exhaust stroke instead of compression stroke. Turn flywheel another 360° in direction of normal rotation until timing pin engages hole in flywheel. See if timing marks are aligned.

5. If timing is correct, replace plugs and reconnect hose.

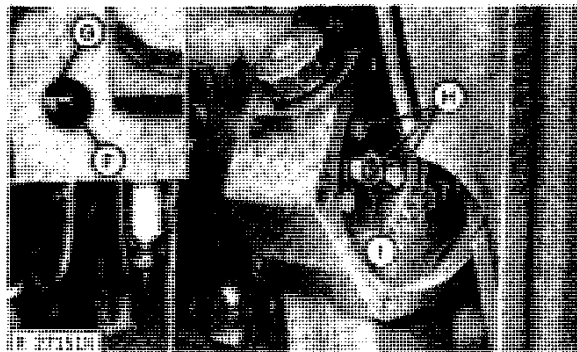

F—Drive Hub Mark      H—Cap Screws  
 G—Pointer Mark      I—Pump Drive Shaft Nut

Fig. 30—Adjusting Timing

6. If timing is not correct, remove timing gear cover. Loosen three cap screws (H), and turn pump drive shaft nut (I) to align timing marks. Tighten cap screws. Replace timing gear cover and plugs, and reconnect hose.

## Starting Engine

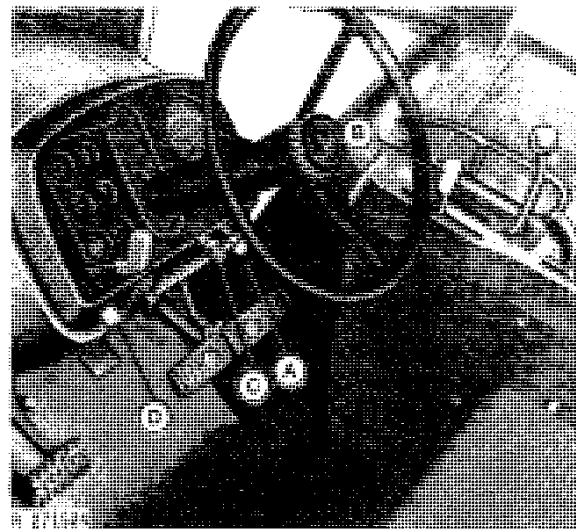

A—Engine Stop Knob      C—Key Switch  
 B—Hand Throttle      D—Electric Starting Aid

Fig. 31—Engine Starting Controls

1. Be sure transmission is in park and everyone is clear of tractor. Push engine stop knob (A, Fig. 31) in, and position hand throttle (B) 1/3 of the way forward.

2. Turn key switch (C) clockwise to first position, and check instrument panel gauges and indicator lights.

(a) Voltmeter should rise to the green band. If it does not, voltage is low, and batteries may have to be charged.

(b) Unless the tractor has a Power Shift transmission, transmission oil indicator lamp should flash. If it does not, turn off key switch and determine cause. See Group 25 of Section 40.

**⚠ CAUTION:** Before starting engine, be sure there is plenty of ventilation. Use exhaust hose to outside if available.

3. Turn key switch fully clockwise to start engine. Release key as soon as engine starts.

**IMPORTANT:** Do not operate starter more than 30 seconds at a time. Wait at least two minutes before trying again. If key is released before engine starts, wait until starter and engine stop turning before trying again.

## Starting Engine—Continued

4. Check instrument panel indicator lights while engine is cranking.

(a) Air cleaner indicator lamp should glow while key switch is in start position. A test circuit is provided to be sure the lamp works.

(b) If the tractor has a Power Shift transmission, the transmission oil indicator lamp should also glow. If lamps do not work properly, refer to Group 25 of Section 40.

5. Note operation of starter. If it does not appear to be working properly, refer to Group 15 (Delco-Remy) or Group 20 (John Deere) of Section 40.

6. If needed, press electric starting aid (D) to inject starting fluid into air intake system.

**IMPORTANT: Inject starting fluid only in short bursts and only while engine is turning.**

7. Check instrument panel gauges and indicator lamps after engine starts. Refer to Group 25 of Section 40 if gauges or lights malfunction.

(a) Indicator lamps should go out.

(b) Oil pressure gauge should rise to green band. Stop engine immediately if it does not.

(c) Voltmeter should rise into green band for charging.

*NOTE: Voltmeter should register higher when engine is running than when engine is stopped. This indicates that alternator is charging.*

(d) Engine temperature gauge and fuel gauge should work correctly.

(e) Speed-hour meter should correctly show engine speed.

8. Check hand throttle and engine stop knob operation. If they do not work smoothly, refer to Group 20 of Section 30.

## Checking Engine Speeds

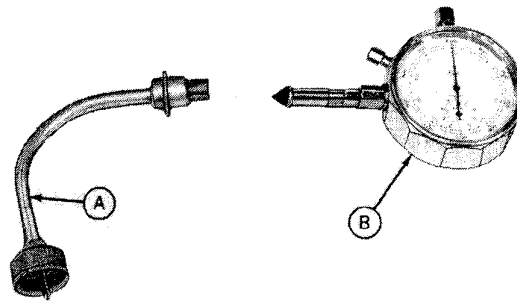

R 26818N

A—JDE-28 Adapter\*

B—Hand Tachometer

Fig. 32—Tools Required for Checking Engine Speeds

\*Order from Service Tools, Box 314, Owatonna, MN 55060.

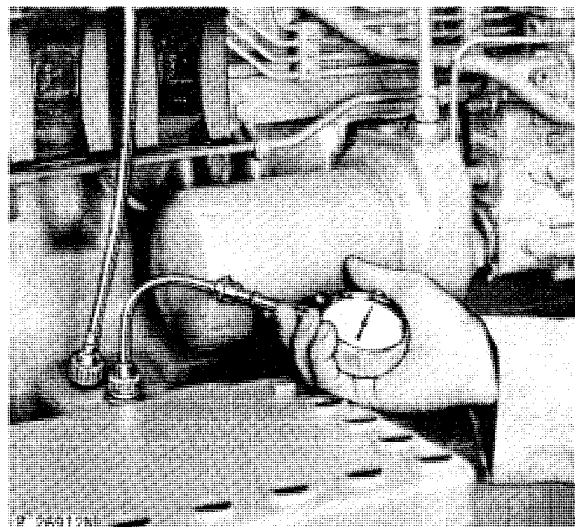

A—JDE-28 Adapter

B—Hand Tachometer

Fig. 33—Checking Engine Speeds

1. With engine stopped, remove tachometer drive cable and install JDE-28 Adapter in its place as shown in Fig. 33.

2. Start engine. Pull throttle all the way rearward to run engine at slow idle. Measure speed with hand tachometer as shown in Fig. 33. Speed should be 780 to 820 rpm.

3. Push throttle all the way forward to run engine at fast idle. Measure speed with hand tachometer. Speed should be 2325 to 2425 rpm.

4. If idle speeds are incorrect, disconnect speed control linkage and test engine speeds as instructed on pages 15-15 through 15-18 of Section 30.

5. If idle speeds are correct with speed control linkage disconnected, check and adjust linkage as instructed in Group 20 of Section 30. If not, remove and repair injection pump as instructed in Group 15 of Section 30.

## OPERATION

### Driving Tests

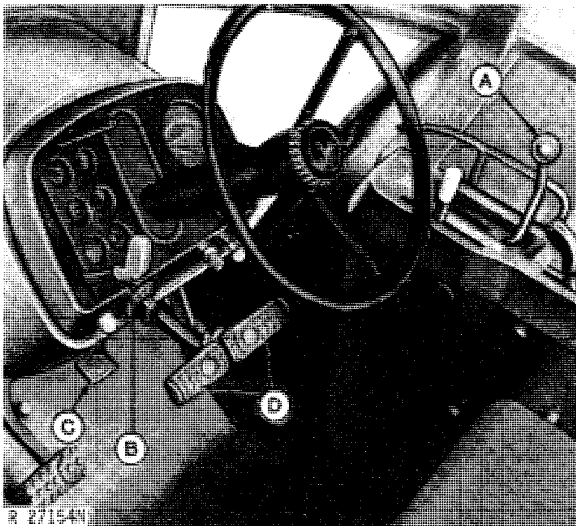

A—Speed Selector                      C—Differential Lock  
B—PTO Clutch Lever                D—Brake Pedals

Fig. 34—Operating Controls

1. Shift transmission through all gears, driving tractor in each gear. If you find any problem in transmission, linkage, shift levers, clutch, or any part of power train, refer to Section 50.

2. Check for smooth operation of all controls. If you find any problem, refer to the appropriate area in this manual.

Power Steering . . . . . Section 70 Group 20  
Power Brakes . . . . . Section 70 Group 25  
Hand Throttle . . . . . Section 30 Group 20  
Foot Throttle . . . . . Section 30 Group 20  
All Lights & Switches . . . . . Section 40 Group 25

3. Check operation of differential lock, if equipped. While driving tractor, depress differential lock pedal (C, Fig. 32). Pedal should remain engaged until brakes are used. Pedal should release when either brake pedal is depressed.

If differential lock does not function properly, refer to Group 40 of Section 50.

4. Check operation of power front-wheel drive, if equipped.

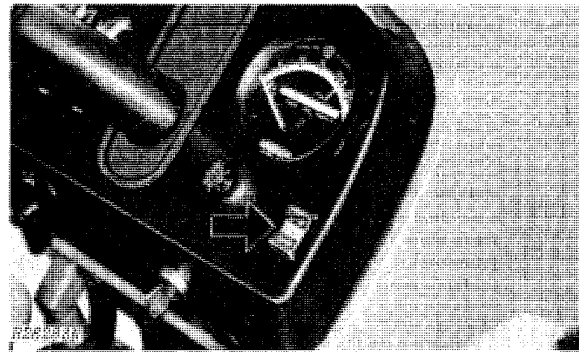

Fig. 35—Power Front-Wheel Drive Switch

(a) If possible, operate tractor on a sandy or graveled surface. This makes it easier to see whether front wheels are pulling.

(b) Operate engine at approximately 2000 rpm.

(c) Drive tractor in each transmission gear. Repeatedly engage and disengage power front-wheel drive switch, both high torque and low torque, in each gear.

### Driving Tests—Continued

(d) By watching front wheels, you should be able to see whether front-wheel drive is engaging. Drive should engage only in the gears listed below.

POWER SHIFT			QUAD-RANGE		
Gear	Lo	Hi	Gear	Lo	Hi
1	x	x	A-1	x	x
2	x	x	A-2	x	x
3	x	x	A-3	x	x
4	x	x	A-4	x	x
5	x		A-1R	x	x
6	x		A-2R	x	x
7			B-1	x	x
8			B-2	x	*
			B-3	x	*
1R	x	x	B-4		*
2R	x	x	B-1R	x	*
3R	x	x	B-2R		*
4R	x	x	C-1	x	*
			C-2	x	*
			C-3	x	*
			C-4		*
1	x	x	C-1R	x	*
2	x	x	C-2R		*
3	x	x	D-1		*
4	x	x	D-2		*
5	x		D-3		*
6	x		D-4		*
7			*Automatically switched to low torque.		
8					
1R	x	x			
2R	x	x			

If you find any problem, refer to Group 5 of Section 40 (for electrical problems) or Group 45 of Section 50 (for hydraulic or mechanical problems).

#### Brake Accumulator

Make sure brake accumulator is working properly. Pedals should have a solid feel for at least five applications after engine has been stopped for at least 15 minutes.

If any problem is found (excessive pedal travel, no solid feel, etc.) refer to Group 25 of Section 70.

### Power Take-Off

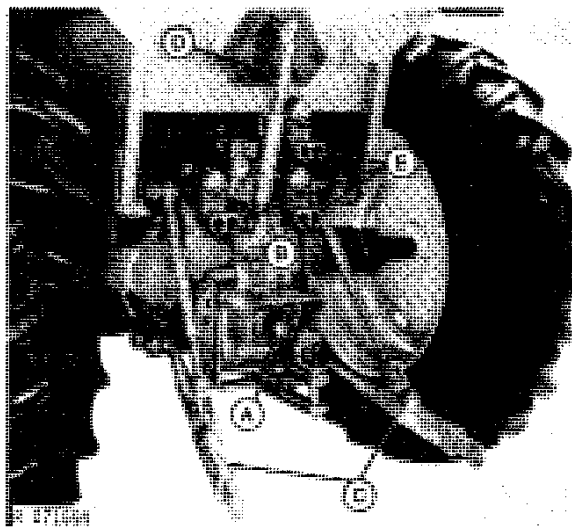

A—PTO Guard  
B—Master Shield  
C—Draft Links  
D—Center Link  
E—Breakaway Couplers

Fig. 36-PTO and Hitch Components

1. Examine both PTO guard and master shield.
2. With PTO guard removed and engine running, make sure PTO shaft rotates when PTO clutch lever is engaged and stops when lever is disengaged.
3. With PTO engaged, shut engine off. Unless tractor has a Power Shift transmission, PTO clutch lever should disengage automatically when engine stops.
4. If you find any problem, refer to Group 10 (Perma-Clutch) or Group 35 (Power Shift) in Section 50.

## Implement Hitch Components

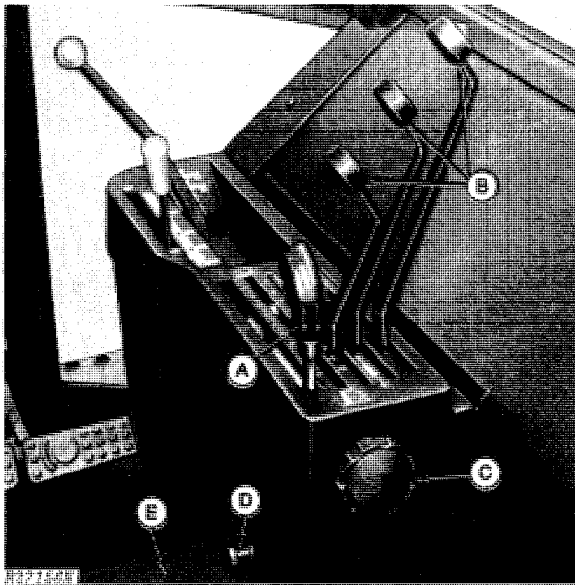

A—Rockshaft Control Lever  
B—Selective Control Levers  
C—Depth Stop Knob  
D—Friction Adjusting Screw  
E—Rockshaft Selector Lever

Fig. 37-Implement Hitch Controls

1. Raise and lower rockshaft several times to make sure it functions smoothly. If control lever is too easy or too hard to move, reset friction adjusting screw (D, Fig. 35).
2. Be sure rockshaft selector lever (E) moves freely. Leave it in the MIN position to prevent unexpected rockshaft movement while hitching implements.
3. Be sure sway blocks are positioned properly.
4. Check Quik-Coupler latches and handles to be sure they are not binding.
5. Attach a remote hydraulic cylinder to a breakaway coupler. See that coupler, coupler operating levers, and rate-of-operation valve function smoothly.
6. Extend and retract cylinder several times. Make sure operating lever automatically returns to neutral when cylinder reaches end of its stroke.
7. Repeat steps 5 and 6 for each breakaway coupler.

8. Inspect all components of implement hitch area. Check for missing parts, damage, oil leaks, or anything which might lead to problems.

## Sound-Gard Body and Operator's Station

1. Be sure windows and door open and close properly. See that seals are properly installed around windows, door, and cowl.

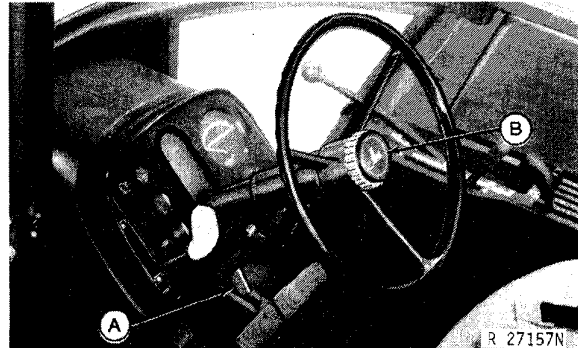

A—Tilt Release Lever      B—Telescope Release Knob

Fig. 38-Tilt-Telescope Steering Wheel

2. Check steering wheel tilt and telescope mechanisms.

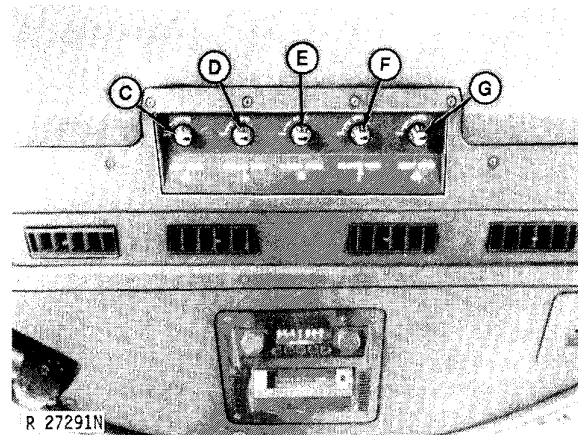

C—Left-Hand Wiper Switch  
D—Air Conditioning Temperature Switch  
E—Blower Switch  
F—Heater Temperature Control  
G—Right-Hand Wiper Switch

Fig. 39-Sound-Gard Body Controls

### Sound-Gard Body and Operator's Station—Continued

3. Check operation of pressurizer blowers, heater, and air conditioner. Run blowers on high and low speeds, and make sure both blower motors are running. If air conditioner does not work, check thermal fuse.

4. Wet windshield, and check wipers for proper sweep angle and park position. If adjustment is needed, refer to Group 25 of Section 40.

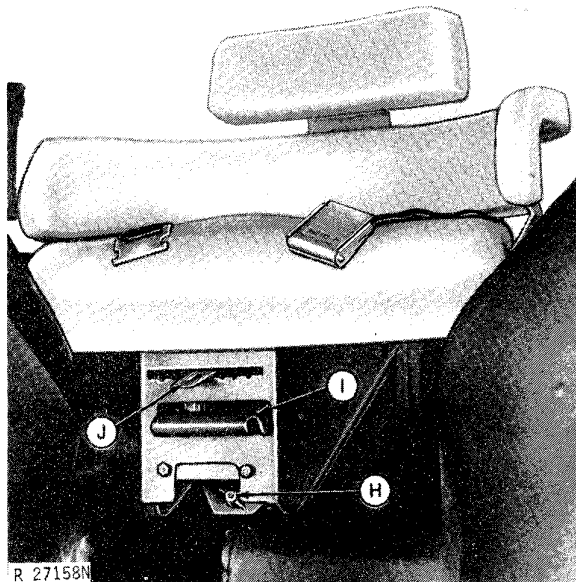

H—Weight Adjustment Screw  
I—Seat Release Latch  
J—Height Adjustment Lever

Fig. 40—Seat Controls (Regular Seat)

5. Inspect seat and its adjustments. To adjust for operator's height, lift seat release lever (I, Fig. 40) and slide seat all the way back. Move height adjustment lever (J) to the desired position, and slide seat forward.

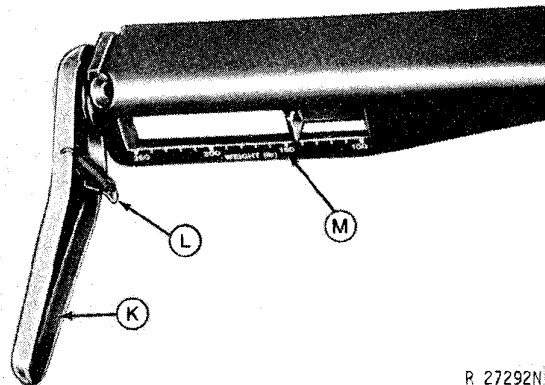

K—Handle  
L—Ratchet Lock

M—Weight Indicator Scale

Fig. 41—Weight Adjustment (Personal Posture Seat)

6. Adjust counterbalance spring if seat does not move all the way back when seat release latch is lifted.

(a) Lift seat release latch, and push seat all the way back.

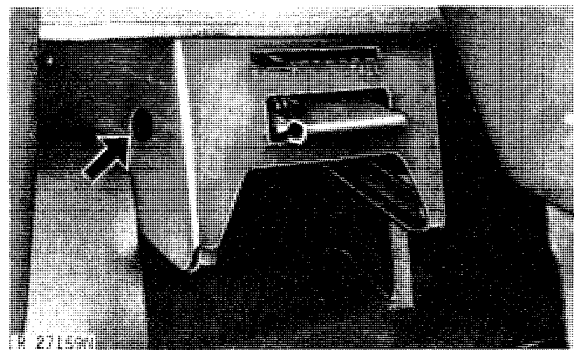
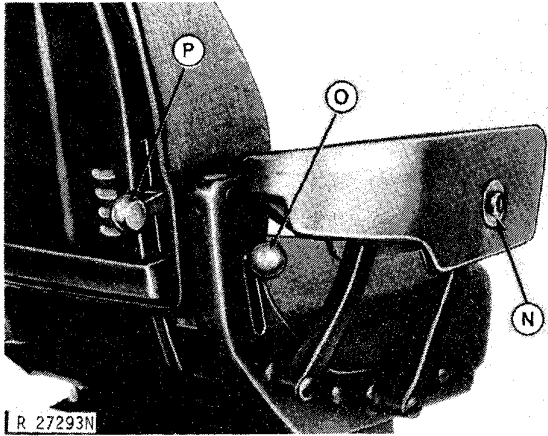

Fig. 42—Counterbalance Spring

(b) Insert screwdriver in slotted end of shaft. Push inward to release shaft. Turn shaft counterclockwise two or three turns, and be sure it engages the locking slots.

7. On Personal Posture Seat, also check armrest height, backrest angle, and lumbar support mechanisms.



N—Armrest Release Button      P—Lumbar Support Control  
 O—Backrest Angle Control

Fig. 43—Personal Posture Seat Controls

8. If you find any problem in seat, refer to Group 15 of Section 80.

**GENERAL**

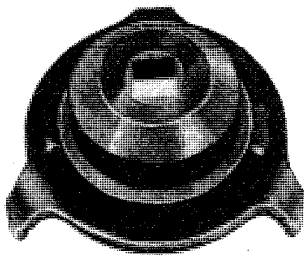

R 26423N

Fig. 44—JDG-11 Adapter\*

\*Order from Service Tools, Box 314, Owatonna, MN 55060.

1. Tighten the following bolts to the torques specified.

	ft-lbs	Nm	kgm
Four-post Roll-Gard mounting bolts . . . . .	150	200	20
Front axle-to-knee bolts			
4430 except Hi-Crop . . . . .	370	500	50
4430 Hi-Crop and 4630 . . . . .	445	600	60
Front wheel-to-hub bolts . . . . .	100	135	14
Special bolts on rear hubs . . . . .	300	410	41
Steel wheel-to-hub bolts . . . . .	240	325	33
Rimclamp-to-wheel bolts . . . . .	170	230	23
Rockshaft lift arm retainers . . . . .	300	410	41

2. Check all other accessible nuts and cap screws. If you find any that are loose, tighten according to the chart on page 20.

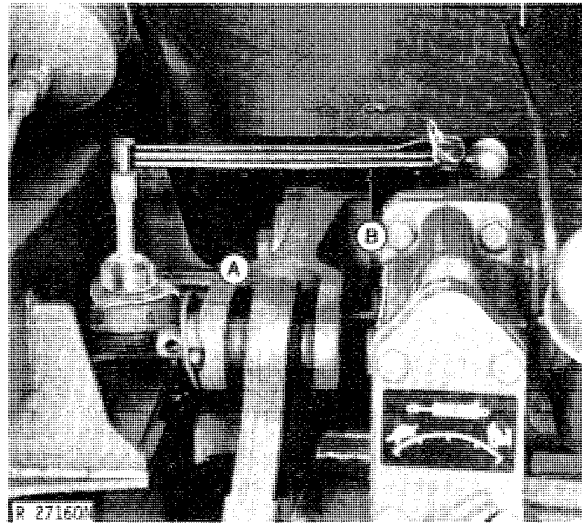

A—JDG-11 Adapter      B—Torque Wrench

Fig. 45—Checking Sound-Gard Body Mount Caps

3. Check Sound-Gard Body mount caps as shown in Fig. 45. Turning cap should require 15 to 25 ft-lbs (20 to 35 Nm) (2 to 3.5 kgm). Tighten or loosen mounting bolt if needed.

*NOTE: On early tractors (4430 serial number -41550 and 4630 serial number -15402) turning cap should require 9 to 11 ft-lbs (12 to 15 Nm) (1.2 to 1.5 kgm).*

4. Check engine, fuel system, cooling system, and hydraulic system for leaks. Correct as necessary.

5. Clean tractor and touch up paint.

**TORQUE CHART**

Bolt Diameter	Plain Head*			Three Radial Dashes*			Six Radial Dashes*		
	ft-lbs	Nm	kgm	ft-lbs	Nm	kgm	ft-lbs	Nm	kgm
1/4 in. (6.35 mm)	6	8	0.8	10	14	1.4	14	19	1.9
5/16 in. (7.93 mm)	13	18	1.8	20	27	2.7	30	41	4.1
3/8 in. (9.53 mm)	23	31	3.1	35	47	4.7	50	70	7.0
7/16 in. (11.11 mm)	35	47	4.7	55	75	7.5	80	110	11
1/2 in. (12.70 mm)	55	75	7.5	85	115	12	120	160	16
9/16 in. (14.29 mm)	75	100	10	130	175	18	175	240	24
5/8 in. (15.88 mm)	105	140	14	170	230	23	240	325	33
3/4 in. (19.05 mm)	185	250	25	300	410	41	425	575	58
7/8 in. (22.23 mm)	160	220	22**	445	600	60	685	930	93
1 in. (25.40 mm)	250	340	34**	670	900	90	1030	1400	140

\*The types of bolts and cap screws are identified by head markings as follows:

Plain Head: regular machine bolts and cap screws.

3-Dash Head: tempered steel high-strength bolts and cap screws.

6-Dash Head: tempered steel extra high-strength bolts and cap screws.

\*\*Machine bolts and cap screws 7/8-inch and larger are sometimes formed hot rather than cold, which accounts for the lower torque.

**DELIVERY SERVICE**

A thorough discussion of the operation and service of a new tractor at the time of delivery helps to assure complete customer satisfaction. Proper delivery should be an important phase of a dealer's program. A portion of the John Deere Delivery Receipt emphasizes the importance of proper delivery service.

Many complaints have arisen simply because the owner was not shown how to operate and service his new tractor properly. Enough time should be devoted, at the customer's convenience, to introducing the owner to his new tractor and explaining to him how to operate and service it.

**IMPORTANT: Install plug in muffler outlet if transporting tractor to customer. This will prevent damage to the turbocharger caused by air passing through the turbocharger and rotating it without lubrication when the engine is stopped.**

The following procedure is recommended before the serviceman and owner complete the delivery acknowledgments portion of the delivery receipt.

Using the tractor operator's manual as a guide, be sure the owner understands these points thoroughly:

1. Controls and instruments.
2. How to start and stop the engine.
3. The importance of the break-in period.
4. How to use liquid or cast-iron ballast.
5. All functions of the hydraulic system.
6. Using the power takeoff.
7. The importance of safety.
8. The importance of lubrication and periodic services.

Give particular emphasis to sway blocks, rockshaft speed-of-drop, rockshaft selector lever (load and depth control), transmission oil indicator light (whether temperature or pressure and what to do if it comes on), voltmeter (how to see whether alternator is charging), and Sound-Gard Body air filters. These areas are very often misunderstood.

After explaining and demonstrating the above features, have the owner sign the delivery receipt and give him the operator's manual.

## AFTER-SALE INSPECTION

The purchaser of a new John Deere tractor is entitled to a free inspection within the warranty period after the equipment has been "run in". The terms of this after-sale inspection are outlined on the back of the John Deere Delivery Receipt.

The purpose of this inspection is to make sure that the customer is receiving satisfactory performance from his tractor. At the same time, the inspection should reveal whether the tractor is being operated, lubricated, and serviced properly.

If the recommended after-sale service inspection is followed, the dealer can eliminate a needless volume of service work by preventing minor irregularities from developing into serious problems later on. This will promote strong dealer-customer relations and present the dealer an opportunity to answer questions that may have arisen during the first few days of operation.

The following inspection program is recommended within the first 100 hours of tractor operation.

### Cooling System

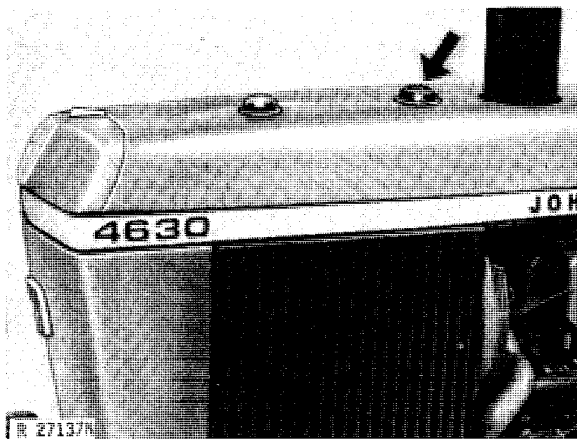

Fig. 46-Radiator Cap

1. Remove radiator cap and check coolant level. Level should be at least 1-1/2-inches (38 mm) above baffle in radiator top tank. If coolant is low, fill to proper level and try to determine why coolant was lost.

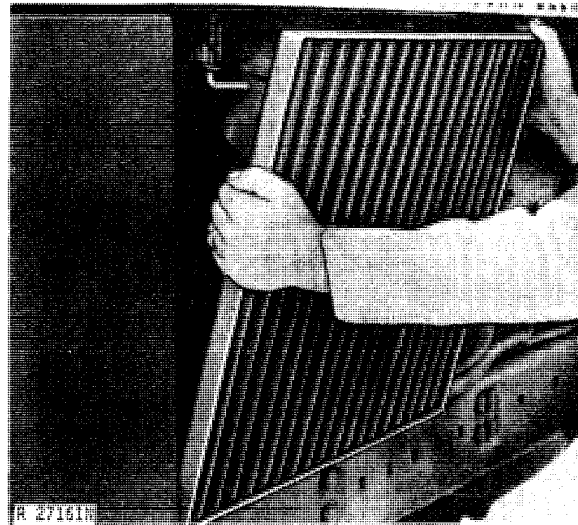

Fig. 47-Removing Side Grille Screen

2. Remove side grille screens. Remove any trash which has accumulated on radiator and oil cooler-condenser.

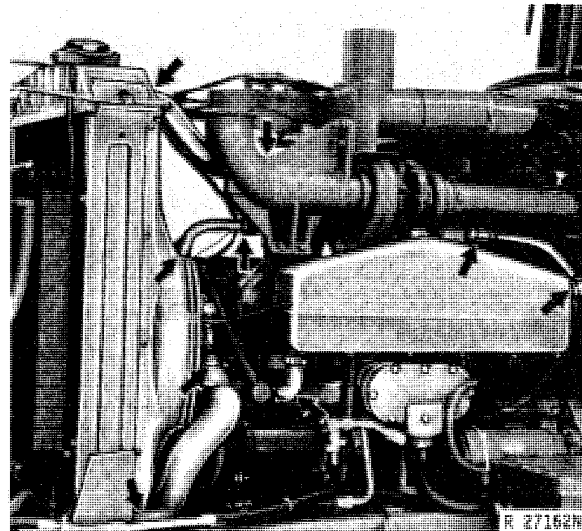

Fig. 48-Cooling System

3. Check all hoses and connections for leaks. Correct as necessary.

## Fuel System

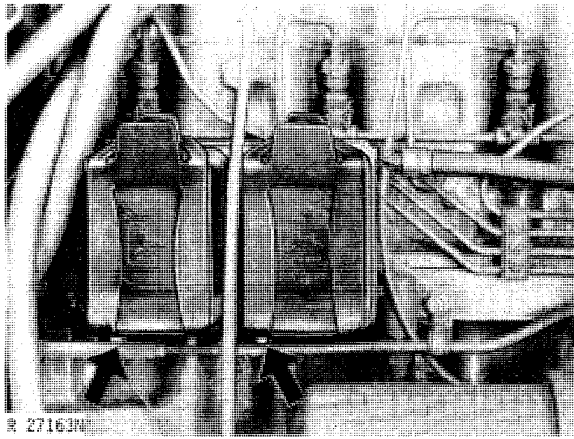
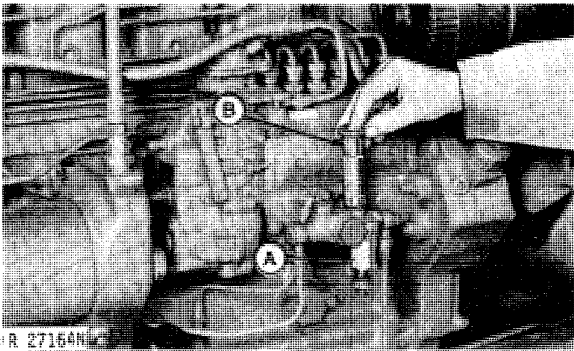

Fig. 49-Fuel Filter Drain Plugs

1. Check fuel filters for water or sediment. If any is present, remove drain plugs and drain it out. Caution customer about importance of proper fuel storage.



A—Sediment Bowl B—Hand Primer

Fig. 50-Fuel Transfer Pump

2. Check sediment bowl (A, Fig. 50) on fuel transfer pump. If water or sediment is present, clean it out. Close valve on bottom of fuel tank before removing sediment bowl.

3. If either fuel filters or sediment bowl is drained, bleed air from system. Loosen hand primer (B) and pump until most of air bubble disappears.

4. Check entire fuel system for leaks. Correct as necessary.

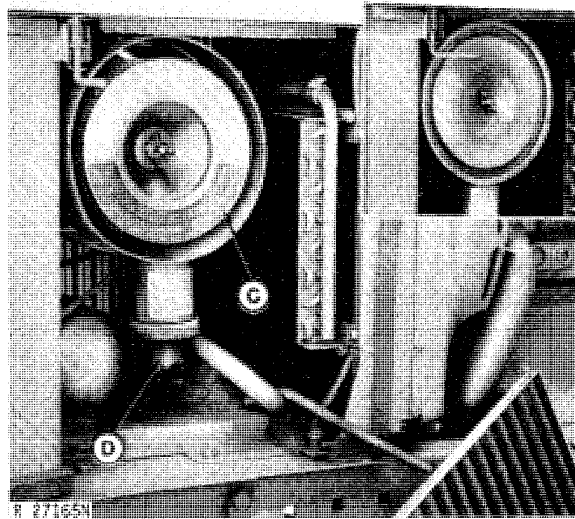

C—Air Cleaner Element D—Dust Unloading Valve

Fig. 51-Air Cleaner (4430 Shown)

5. Inspect air cleaner element (C, Fig. 51) and dust unloading valve (D). Clean element if needed.

## Lubrication

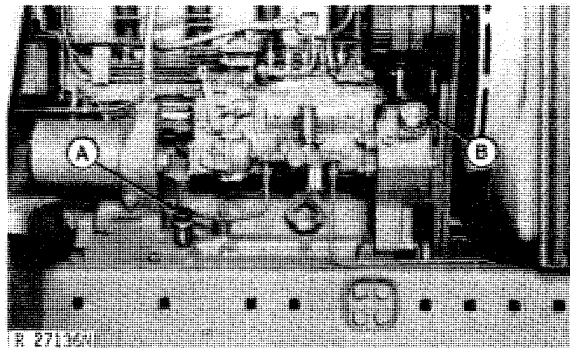

A—Dipstick B—Filler Cap

Fig. 52-Crankcase Dipstick and Filler Cap

1. With the tractor on level ground and the engine stopped for 10 minutes or more, loosen the dipstick and remove it. Observe the engine oil level on the dipstick, with the dipstick seated evenly. If the oil level is down to the lower marks on the dipstick, add sufficient John Deere Torq-Gard Supreme Engine Oil or its equivalent of the proper viscosity to bring the level to the upper marks.

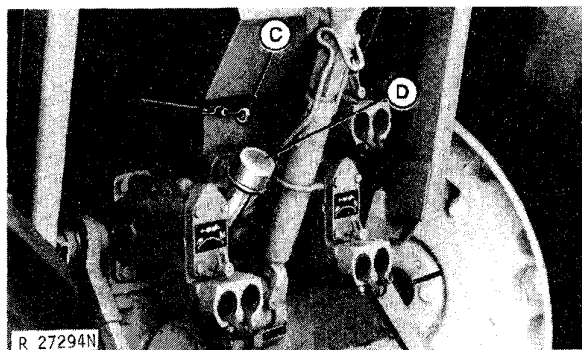

C—Dipstick

D—Filler Cap

Fig. 53-Transmission-Hydraulic System Dipstick

2. With the tractor on level ground, check the transmission-hydraulic system oil level with the dipstick. If the oil level is down to the "ADD" mark at the bottom of the "SAFE" range on the dipstick, remove the filler cap and add John Deere Hy-Gard Transmission and Hydraulic Oil or its equivalent to bring the oil level up to the top of the "SAFE" range.

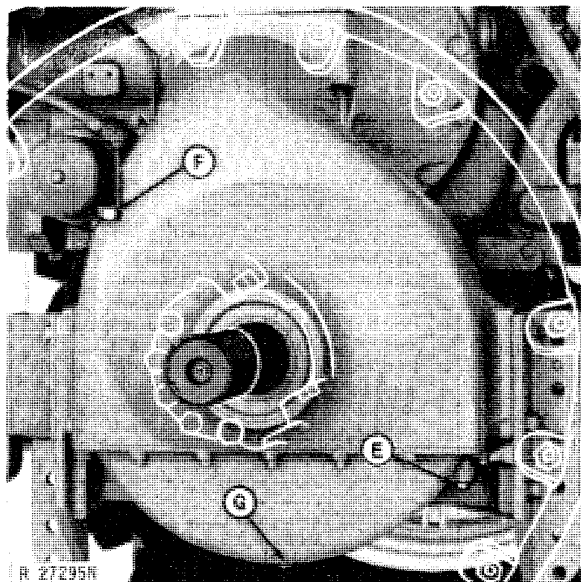

E—Oil Level Plug  
F—Filler Plug

G—Drain Plug

Fig. 54-Hi-Crop Final Drive Housing

3. Remove oil level plug (E, Fig. 54) from each final drive housing and check oil level. If low, add gear lubricant at filler plug (F). Use John Deere Gear Lubricant or its equivalent. Use SAE 90 at temperatures above 32°F (0°C) and SAE 80 at temperatures below 32°F (0°C).

## Electrical System

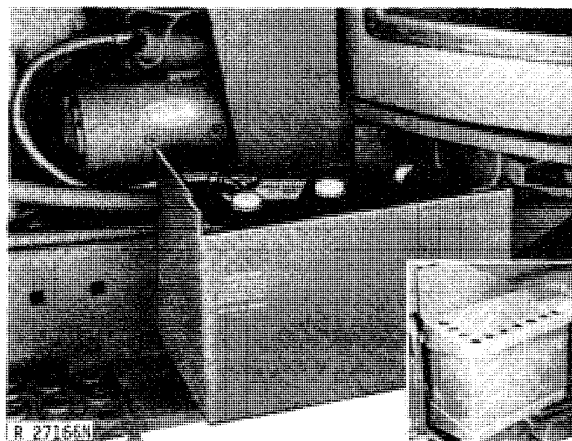

Fig. 55-Battery Compartment

1. Check specific gravity of batteries with a hydrometer. Specific gravity, corrected to 80°F (27°C) is 1.260 for a fully charged battery. To correct for temperature of electrolyte, add 0.004 for every 10°F above 80°F (0.007 for every 10°C above 27°C). Subtract at the same rate if electrolyte is below 80°F (27°C).

If batteries are not near full charge, try to determine the reason. Refer to Group 10 of Section 40.

2. Check level of electrolyte in each cell of each battery. Level should be to bottom of filler neck. If water is needed, use clean, mineral-free water.

If water must be added to batteries more often than every 200 hours, alternator may be overcharging. Refer to Group 10 of Section 40.

**Electrical System—Continued**

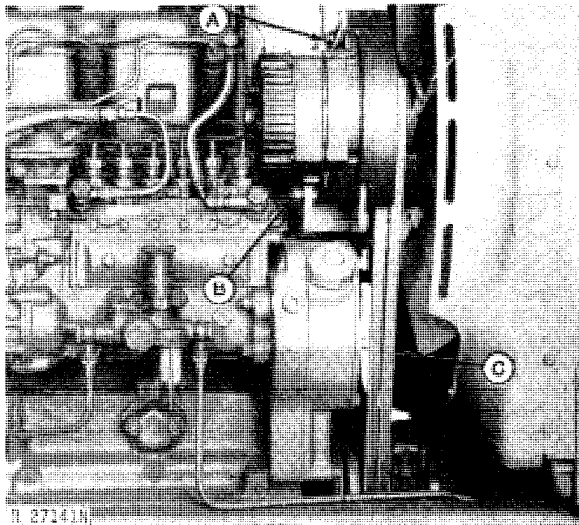

A—Adjusting Cap Screw      C—1" (25 mm) Flex  
 B—Mounting Bolt

*Fig. 56-Adjusting Fan Belt Tension*

3. Check tension of fan belts and air conditioning compressor belt. Adjust if necessary. Fan belts should deflect one inch (25 mm) when a 25-pound (110 N) force is applied midway between pulleys.

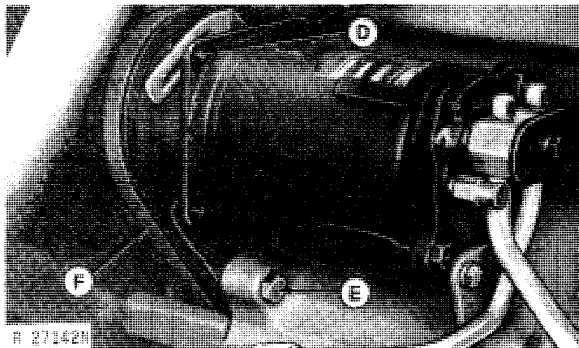

D—Adjusting Cap Screw      F—1/4" (6 mm) Flex  
 E—Mounting Bolt

*Fig. 57-Adjusting Compressor Belt Tension*

4. Compressor belt should deflect one-fourth inch (6 mm) when a 15-pound (65 N) force is applied midway between pulleys.

5. Check operation of all lights. If you find any problem, refer to Group 25 of Section 40.

6. Follow engine starting instructions beginning on page 13. Check operation of starter, gauges, and indicator lamps.

**OPERATION**

Perform all checks as instructed under "OPERATION" beginning on page 15.

1. Driving tests.
2. Brake accumulator.
3. Power take-off.
4. Implement hitch components.
5. Sound-Gard Body and operator's station.

**ENGINE**

1. Check engine speeds as instructed on page 14.
2. Check engine valve clearance as instructed in Group 10 of Section 20. Intake valve clearance should be 0.016 to 0.022 in. (0.4 to 0.6 mm). Exhaust valve clearance should be 0.026 to 0.032 in. (0.7 to 0.8 mm).

**GENERAL**

1. Tighten the following bolts to the torques specified.

	ft-lbs	Nm	kgm
Four-post Roll-Gard Mounting bolts	150	200	20
Front axle-to-knee bolts			
4430 except Hi-Crop	370	500	50
4430 Hi-Crop and 4630	445	600	60
Front wheel-to-hub bolts	100	135	14
Special bolts on rear hubs	300	410	41
Steel wheel-to-hub bolts	240	325	33
Rim clamp-to-wheel bolts	170	230	23
Rockshaft lift arm retainers	300	410	41

2. Check all other accessible nuts and cap screws. If you find any that are loose, tighten according to the chart on page 20.

3. Check engine, fuel system, cooling system, and hydraulic system for leaks. Correct as necessary.

4. Check air conditioner sight glass as instructed in Group 5 of Section 80.

## Group 15 TUNE-UP

### PRELIMINARY ENGINE TESTING

Before tuning up a tractor, determine whether a tune-up will restore operating efficiency. When there is doubt, the following preliminary tests will help to determine if the engine can be tuned up. If the condition is satisfactory, proceed with the tune-up. Choose from the following procedures only those necessary to restore the unit.

1. After engine has been stopped for several hours, carefully loosen crankcase drain plug and watch for any water to seep out. A few drops could be due to condensation, but any more than this would indicate problems which require engine repairs rather than just a tune-up. Refer to Section 20.

2. With engine stopped, inspect engine coolant for an oil film. With engine running, inspect coolant for air bubbles. Either condition would indicate problems which require engine repairs rather than just a tune-up. Refer to Section 20.

3. Perform a dynamometer test as instructed in Group 5 of Section 20, and record horsepower. Repeat dynamometer test after tune-up, so horsepower output before and after tune-up can be compared.

At 2200 engine rpm, output should be 125 horsepower (93 kW) for 4430 Tractors and 150 horsepower (112 kW) for 4630 Tractors.

4. Perform compression test as instructed in Group 5 of Section 20. If test is performed as outlined, compression should be 330 to 370 psi (22.5 to 25.5 bar) (23 to 26 kg/cm<sup>2</sup>).

### ENGINE TUNE-UP

#### Air Intake System

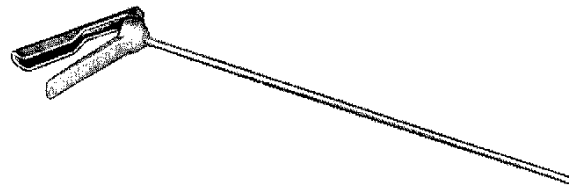

R27167W

Fig. 1-AR62377 Dry Element Cleaning Gun

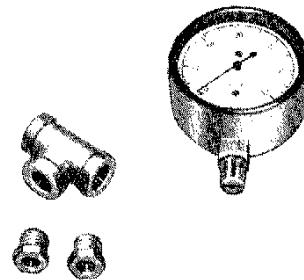

R27169B

Fig. 2-D-05022ST Water Vacuum Gauge\*  
(Formerly JDST-11)

\*Order from Service Tools, Box 314, Owatonna, MN 55060.

### Air Intake System—Continued

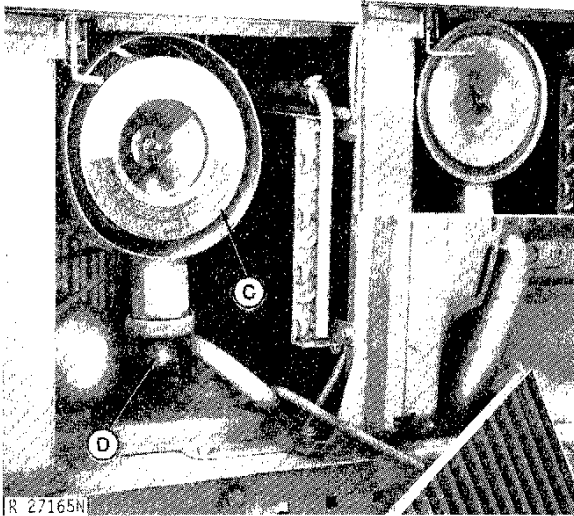

A—Air Cleaner Element      B—Dust Unloading Valve

Fig. 3-Air Cleaner (4430 Shown)

1. Inspect air cleaner primary element (A, Fig. 3). If dirty, clean by patting element with your hand or use AR62377 Dry Element Cleaning Gun.

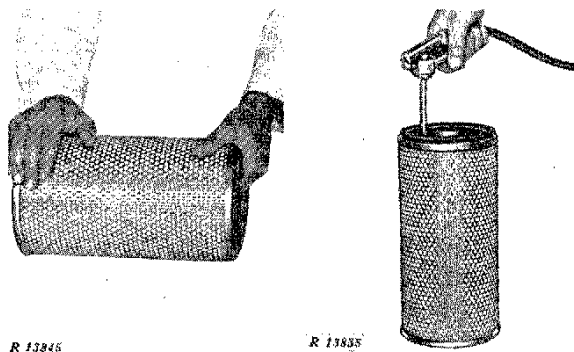

Fig. 4-Cleaning Filter Element

**IMPORTANT:** Do not blow air from outside of element to inside. Be sure metal screen does not touch paper element, as it would quickly rub holes. Inspect element carefully before reinstalling. Do not clean secondary element.

*NOTE:* Both primary and secondary elements should be replaced at least once a year. During a tune-up is a good time to perform this service.

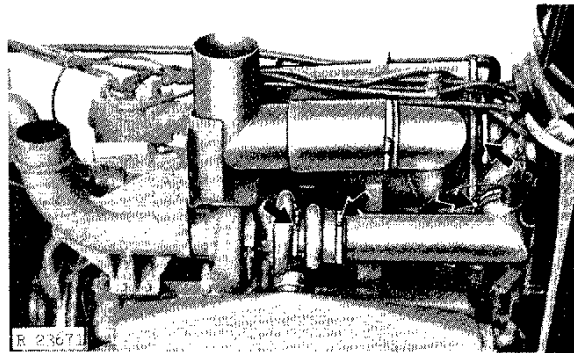

Fig. 5-Air Intake Connections (4630 Shown)

2. Check all connections in air intake system for possible leaks. Tighten any loose clamps. Be sure rubber dust unloading valve is in good condition.

3. Check for restrictions in air intake system by measuring vacuum.

(a) Run engine and bring to operating temperature.

(b) Remove side shields, grille screens, air stack extension, muffler, and hood.

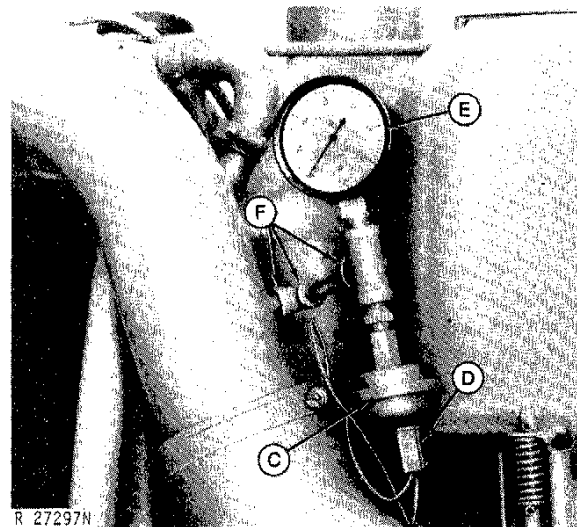

C—Switch      E—Water Vacuum Gauge  
D—Wiring Connector      F—Pipe Fittings

Fig. 6-Testing Air Intake System Restriction

(c) Disconnect wiring connector (D, Fig. 6) from switch (C). Unscrew switch from connection on air intake pipe.

(d) Install a 1/8-inch elbow pipe fitting on intake pipe. Connect "T" and pipe nipple fittings to elbow. This connection facilitates testing restriction indicator switch in step 4.

(e) Connect vacuum gauge to one side of "T" and indicator switch to other side. Connect wiring to switch.

**NOTE:** The vacuum gauge is calibrated in inches of water. A water manometer may also be used.

(f) Operate engine at full load and note gauge reading. With clean filter elements, at 2200 engine rpm and full load, vacuum should be 10-1/2 to 11-1/2 inches of water (26 to 29 mbar). Maximum permitted vacuum is 25 inches of water (62 mbar).

(g) If vacuum is excessive, try to find and correct the cause.

4. While checking air intake system for restrictions, it is a good idea to check operation of restriction indicator switch.

With engine running as in part f of step 3, use a piece of cardboard to partially cover air cleaner intake. Increase the restriction until air cleaner indicator light comes on, and note vacuum reading.

Restriction indicator switch should close at 24 to 26 inches of water (60 to 65 mbar). If it does not, replace it.

5. Check intake manifold pressure as instructed in Group 5 of Section 30. (Note that 6404T engine and 6404A engine are covered separately.)

At 2200 rpm and full load, manifold pressure should be 15 to 17 psi (1.0 to 1.1 bar) (1.0 to 1.1 kg/cm<sup>2</sup>) for 4430 Tractors and 16 to 20 psi (1.1 to 1.4 bar) (1.1 to 1.4 kg/cm<sup>2</sup>) for 4630 Tractors.

## Exhaust System

Inspect exhaust system for any leaks or restrictions. Correct as necessary.

## Crankcase Ventilation System

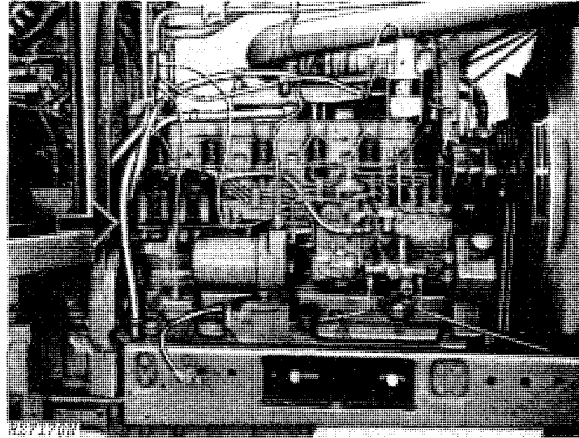

Fig. 7-Crankcase Vent Tube

Inspect crankcase ventilation system for restrictions. Lack of ventilation causes sludge to form in engine crankcase. This can lead to clogging of oil passages, filters, and screens, resulting in serious engine damage.

Clean crankcase vent tube in solvent if it is restricted.

## Cooling System

1. Clean side grille screens if dirty.

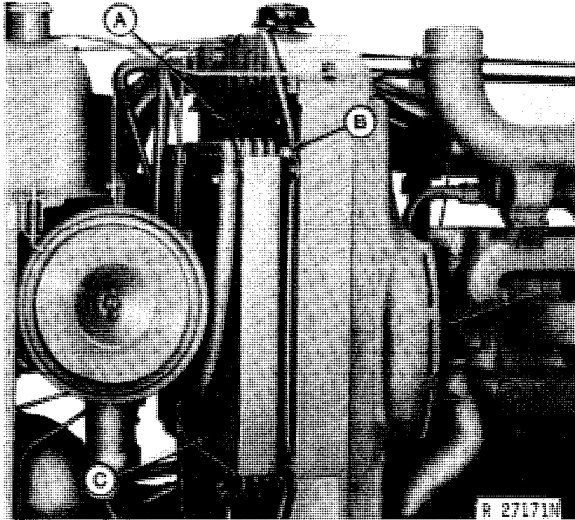

A—Radiator  
B—Cap Screw

C—Oil Cooler-  
Condenser

Fig. 8-Radiator and Oil Cooler-Condenser

2. Clean radiator and oil cooler-condenser. To clean portion of radiator behind oil cooler-condenser unit, remove the two screws at top of unit. Slide unit to one side to expose half the radiator. After cleaning that half, slide the unit to the other side. Replace cap screws when finished.

3. Drain and flush cooling system.

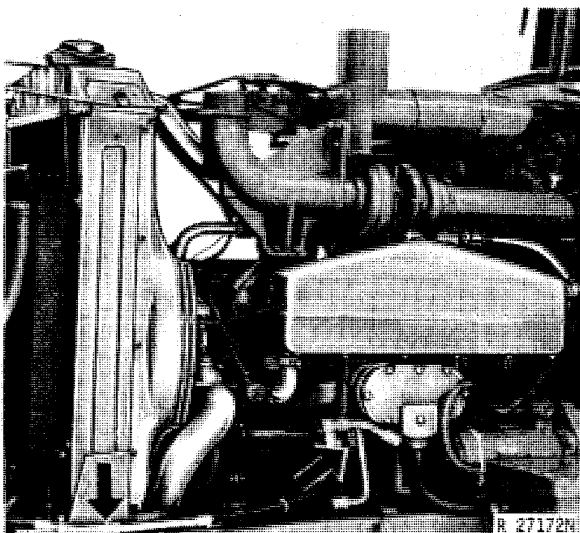

Fig. 9-Cooling System Drain Cocks

- (a) Drain cooling system by opening drain cocks on radiator and engine block.

- (b) Turn Sound-Gard Body heater on and leave it on until finished.

- (c) Close drain cocks and fill cooling system with clean water.

- (d) Run engine until it reaches operating temperature to stir up possible rust or sediment.

- (e) Stop engine and drain coolant before rust or sediment settles.

- (f) Close drain cocks and fill cooling system with a solution of John Deere Cooling System Cleaner and water. Follow the instructions with the cleaner.

- (g) After cleaning, flush the system with clean water.

- (h) Fill cooling system with clean, soft water and antifreeze. Use a permanent-type, ethylene glycol antifreeze which contains a rust inhibitor but does not contain a stop-leak additive.

- (i) Recheck coolant level after starting engine. Coolant should be 1-1/2 inches (40 mm) above baffle in radiator top tank.

Cooling system capacity is 30 U.S. quarts (28 l) for 4430 Tractors and 36 U.S. quarts (34 l) for 4630 Tractors. Add 2 quarts (2 l) for Sound-Gard Body heater.

4. Remove and check thermostats as instructed in Group 30 of Section 20. Thermostats should open at 160 to 180°F (71 to 82°C).

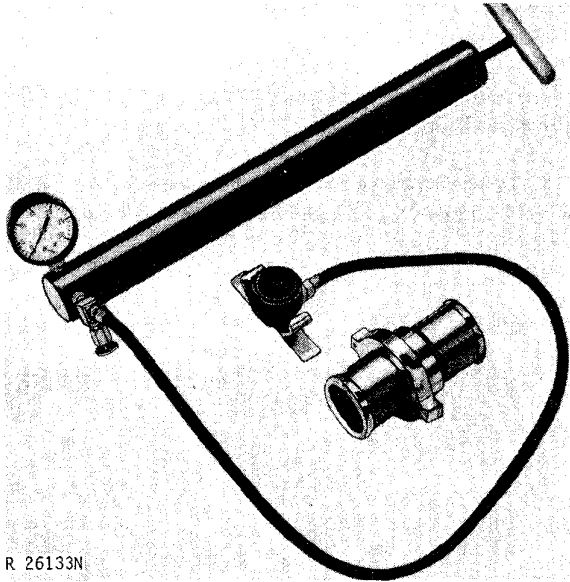

R 26133N

Fig. 10-BT-11-52 Radiator Tester\*

\*Order from Service Tools, Box 314, Owatonna MN 55060.

5. Check radiator and pressure cap for leaks.

(a) Visually check cooling system for leaks or damage.

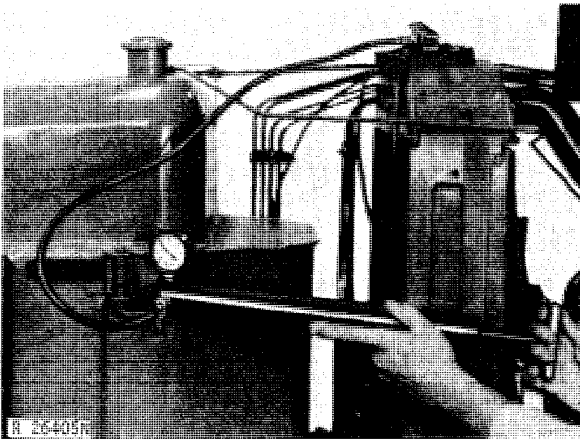

R 26405N

Fig. 11-Testing Radiator

(b) Attach BT-11-52 Radiator Tester to radiator filler neck, and pump pressure up to 10 psi (0.7 bar) (0.7 kg/cm<sup>2</sup>).

(c) Cooling system should hold the pressure. If it does not, try to find and correct the problem.

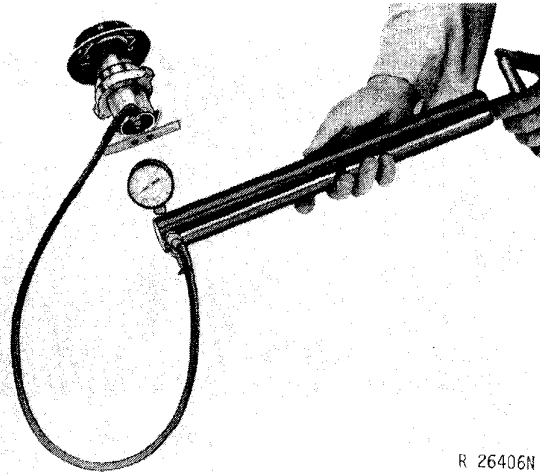

R 26406N

Fig. 12-Testing Pressure Cap

(d) Install pressure cap on radiator tester, and pump pressure up to limit of pressure cap. Cap should maintain 6.25 to 7.50 psi (0.4 to 0.5 bar) (0.4 to 0.5 kg/cm<sup>2</sup>) pressure. If it does not, replace it.

## Diesel Fuel System

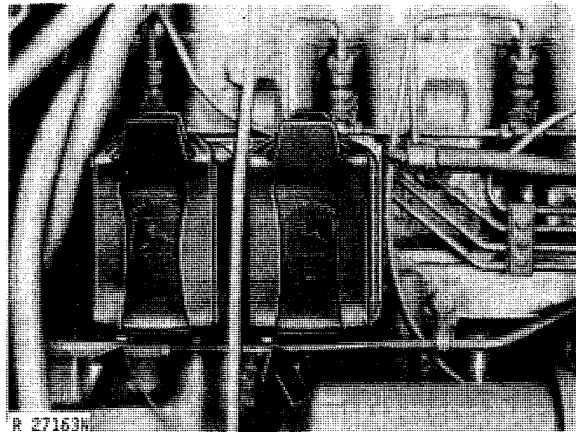

R 27163N

Fig. 13-Fuel Filter Drain Plugs

1. Check fuel filters for water or sediment. If any is present, remove drain plugs and drain it out. Caution customer about importance of proper fuel storage.

**NOTE:** Fuel filters must be replaced periodically to prevent excessive restriction. During a tune-up is a good time to perform this service.

## Diesel Fuel System—Continued

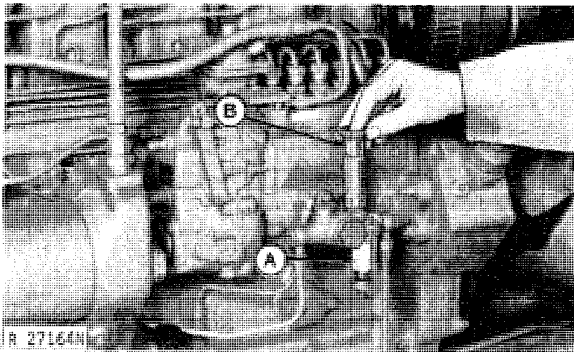

A—Sediment Bowl      B—Hand Primer

Fig. 14-Fuel Transfer Pump

2. Check sediment bowl (A, Fig. 14) on fuel transfer pump. If water or sediment is present, clean it out. Close valve on bottom of fuel tank before removing sediment bowl.

3. If either fuel filters or sediment bowl is drained, bleed air from system. Loosen hand primer (B) and pump until most of air bubble disappears.

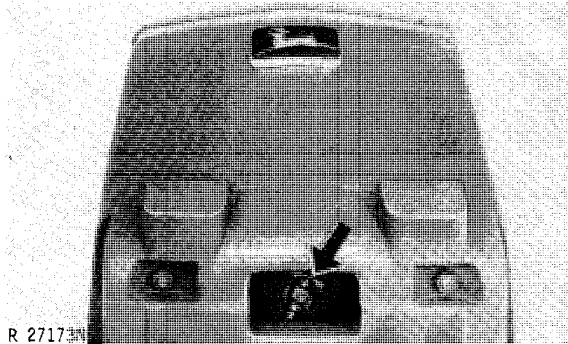

Fig. 15-Fuel Tank Shut-Off Valve

4. Drain any water or sediment from fuel tank.
  - (a) On tractors with only a drain cock on bottom of tank, simply open drain cock.
  - (b) On tractors with only a fuel line and shut-off valve on bottom of tank, shut valve off, disconnect fuel line, and loosen or remove valve.
  - (c) On tractors with both a fuel line and a plug on bottom of tank, loosen or remove plug.

5. Check entire fuel system for leaks. Correct as necessary.

6. Check injection pump timing as instructed in Group 10 of this section.

7. Check engine idle speeds as instructed in Group 10 of this section. Slow idle speed should be 780 to 820 rpm, and fast idle speed should be 2325 to 2425 rpm.

## Electrical System

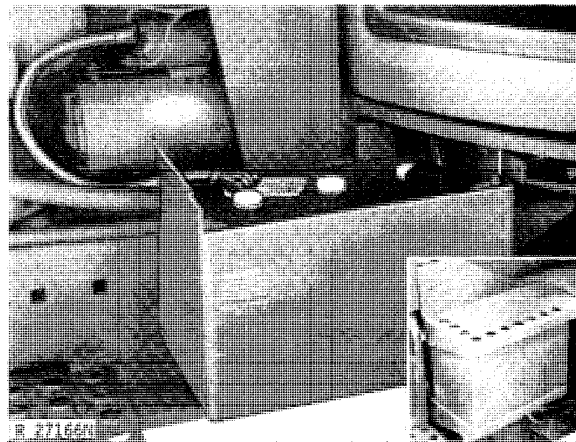

Fig. 16-Battery Compartment

1. Clean batteries, cables, and compartments with a damp cloth. If corrosion is present, remove it and wash the terminals with a solution of ammonia or baking soda in water. Then flush area with clean water.

2. Coat battery terminals and connectors with petroleum jelly mixed with baking soda to retard corrosion.

3. Check specific gravity of batteries with a hydrometer. Specific gravity, corrected to 80°F (27°C) is 1.260 for a fully charged battery. To correct for temperature of electrolyte, add 0.004 for every 10°F above 80°F (0.007 for every 10°C above 27°C). Subtract at the same rate if electrolyte is below 80°F (27°C).

If batteries are not near full charge, try to determine the reason. Refer to Group 10 of Section 40.

4. Check level of electrolyte in each cell of each battery. Level should be to bottom of filler neck. If water is needed, use clean, mineral-free water.

If water must be added to batteries more often than every 200 hours, alternator may be overcharging. Refer to Group 10 of Section 40.

5. If batteries appear to be either undercharged or overcharged, check alternator and charging circuit. Follow diagnosis and testing procedures outlined in Group 10 of Section 40.

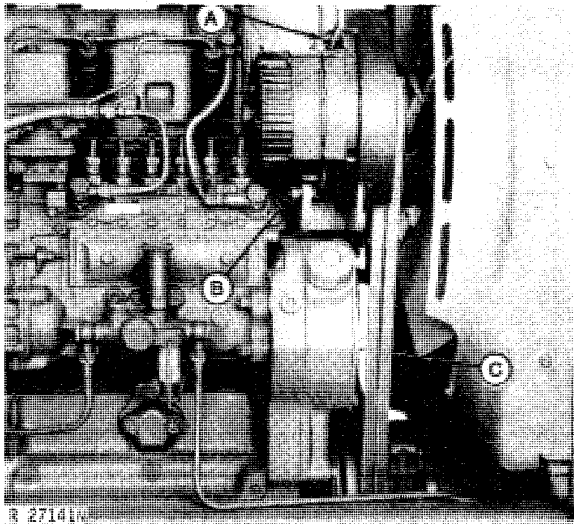

A—Adjusting Cap Screw      C—1" (25 mm) Flex  
B—Mounting Bolt

Fig. 17-Adjusting Fan Belt Tension

6. Check tension of fan belts. Adjust if necessary. Fan belts should deflect one inch (25 mm) when a 25-pound (110 N) force is applied midway between pulleys.

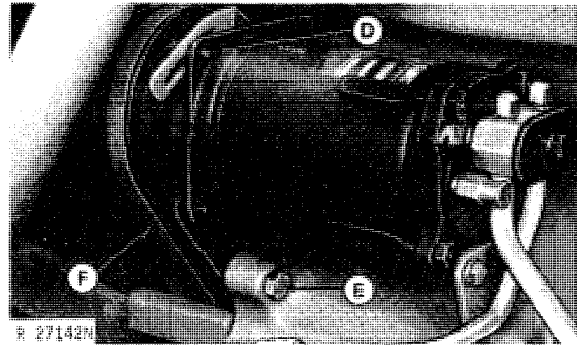

D—Adjusting Cap Screw      F—1/4" (6 mm) Flex  
E—Mounting Bolt

Fig. 18-Adjusting Compressor Belt Tension

7. Check tension of air conditioning compressor belt. Adjust if necessary. Belt should deflect one-fourth inch (6 mm) when a 15-pound (65 N) force is applied midway between pulleys.

8. Check operation of all lights. If you find any problem, refer to Group 25 of Section 40.

9. Check operation of start-safety switch. Starter should not operate unless transmission is in neutral or park.

10. Follow engine starting instructions beginning on page 13 in Group 10 of this Section. Check operation of starter, gauges, and indicator lights.

11. Check air conditioner sight glass as instructed in Group 5 of Section 80.

## Final Engine Test

Repeat dynamometer test as instructed in Group 5 of Section 20. Compare performance with previous test, and record for future reference.

At 2200 engine rpm, output should be 125 horsepower (93 kW) for 4430 Tractors and 150 horsepower (112 kW) for 4630 Tractors.

## OPERATION

Perform all checks as instructed under "OPERATION" beginning on page 15 in Group 10 of this section.

1. Driving tests.
2. Brake accumulator.
3. Power take-off.
4. Implement hitch components.
5. Sound-Gard Body and operator's station.

If you find or suspect any problem with any component, refer to the appropriate area in this manual.

## GENERAL

### Checking Tire Inflation Pressure

Check inflation pressure of all tires before delivering tractor. Adjust pressure to the maximums listed below. The customer can then easily reduce pressure slightly if necessary, depending on how tractor is to be used.

### Rear Tires

Tire Size	Ply Rating	Maximum Pressure
12.4-42	6	12 psi (0.8 bar) (0.8 kg/cm <sup>2</sup> )
15.5-38	6	20 psi (1.4 bar) (1.4 kg/cm <sup>2</sup> )
15.5-38	8	26 psi (1.8 bar) (1.8 kg/cm <sup>2</sup> )
16.9-38	8	24 psi (1.7 bar) (1.7 kg/cm <sup>2</sup> )
18.4-34	6	16 psi (1.1 bar) (1.1 kg/cm <sup>2</sup> )
18.4-34	8	20 psi (1.4 bar) (1.4 kg/cm <sup>2</sup> )
18.4-38	6	16 psi (1.1 bar) (1.1 kg/cm <sup>2</sup> )
18.4-38	8	20 psi (1.4 bar) (1.4 kg/cm <sup>2</sup> )
18.4-38	10	26 psi (1.8 bar) (1.8 kg/cm <sup>2</sup> )
20.8-34	6	18 psi (1.2 bar) (1.2 kg/cm <sup>2</sup> )
20.8-34	8	18 psi (1.2 bar) (1.2 kg/cm <sup>2</sup> )
20.8-38	8	18 psi (1.2 bar) (1.2 kg/cm <sup>2</sup> )
20.8-38	10	22 psi (1.5 bar) (1.5 kg/cm <sup>2</sup> )
23.1-30	8	16 psi (1.1 bar) (1.1 kg/cm <sup>2</sup> )
23.1-34	8	16 psi (1.1 bar) (1.1 kg/cm <sup>2</sup> )
24.5-32	10	20 psi (1.4 bar) (1.4 kg/cm <sup>2</sup> )

### Front Tires

Tire Size	Ply Rating	Maximum Pressure
7.5L-15	6	44 psi (3.0 bar) (3.0 kg/cm <sup>2</sup> )
7.50-18	6	44 psi (3.0 bar) (3.0 kg/cm <sup>2</sup> )
7.50-20	6	44 psi (3.0 bar) (3.0 kg/cm <sup>2</sup> )
9.50-20	8	44 psi (3.0 bar) (3.0 kg/cm <sup>2</sup> )
10.00-16	6	32 psi (2.2 bar) (2.2 kg/cm <sup>2</sup> )
11L-15	6	32 psi (2.2 bar) (2.2 kg/cm <sup>2</sup> )
11.00-16	8	40 psi (2.8 bar) (2.8 kg/cm <sup>2</sup> )
12.4-24	6	24 psi (1.7 bar) (1.7 kg/cm <sup>2</sup> )
14L-16.1	6	28 psi (1.9 bar) (1.9 kg/cm <sup>2</sup> )
14.9-24	6	20 psi (1.4 bar) (1.4 kg/cm <sup>2</sup> )

### Packing Front Wheel Bearings

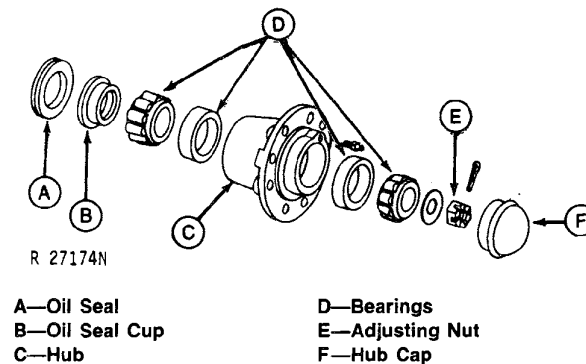

Fig. 19-Front Wheel Bearings

1. Disassemble and clean front wheel bearings.
2. Inspect bearings carefully and replace them if they are worn. If three deep grooves are worn in oil seal cup, replace cup and seal.
3. Pack bearings with wheel bearing grease. Pack seal lips with John Deere Multi-Purpose Lubricant or its equivalent.
4. Install wheel and tighten adjusting nut until a slight drag is felt when wheel is rotated.
5. Back nut off just enough to insert cotter pin in first hole.

### Checking Toe-In

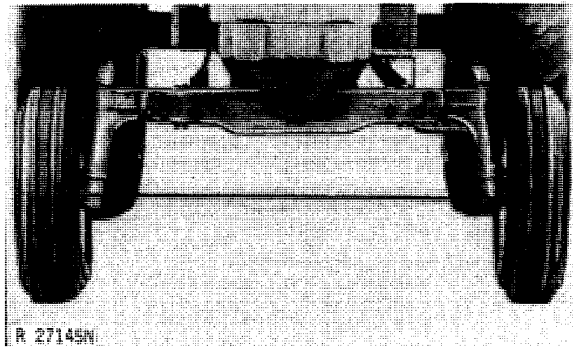

Fig. 20-1/8 to 3/8 in. (3 to 9 mm) Toe-In

To check toe-in, steer front wheels straight ahead and measure distance from tire to tire, first at front of tires and then at rear. Front measurement should be 1/8 to 3/8 inch (3 to 9 mm) less than rear.

If toe-in adjustment is needed, remove bolts from tie rod tubes and loosen clamps on inner ends of tie rods. Turn tie rod tubes in or out until toe-in is correct. Replace bolts and tighten clamps.

Tie rods should be adjusted to equal length, so tractor will turn equally sharp in either direction.

### Miscellaneous

1. Tighten the following bolts to the torques specified.

	ft-lbs	Nm	kgm
Four-post Roll-Gard mounting bolts . . . . .	150	200	20
Front axle-to-knee bolts			
4430 except Hi-Crop . . . . .	370	500	50
4430 Hi-Crop and 4630 . . . . .	445	600	60
Front wheel-to-hub bolts . . . . .	100	135	14
Special bolts on rear hubs . . . . .	300	410	41
Steel wheel-to-hub bolts . . . . .	240	325	33
Rim clamp-to-wheel bolts . . . . .	170	230	23
Rockshaft lift arm retainers . . . . .	300	410	41

2. Check all other accessible nuts and cap screws. If you find any that are loose, tighten according to the chart below.

3. Check engine, fuel system, cooling system, and hydraulic system for leaks. Correct as necessary.

### TORQUE CHART

Bolt Diameter	Plain Head*			Three Radial Dashes*			Six Radial Dashes*		
	ft-lbs	Nm	kgm	ft-lbs	Nm	kgm	ft-lbs	Nm	kgm
1/4 in. (6.35 mm)	6	8	0.8	10	14	1.4	14	19	1.9
5/16 in. (7.93 mm)	13	18	1.8	20	27	2.7	30	41	4.1
3/8 in. (9.53 mm)	23	31	3.1	35	47	4.7	50	70	7.0
7/16 in. (11.11 mm)	35	47	4.7	55	75	7.5	80	110	11
1/2 in. (12.70 mm)	55	75	7.5	85	115	12	120	160	16
9/16 in. (14.29 mm)	75	100	10	130	175	18	175	240	24
5/8 in. (15.88 mm)	105	140	14	170	230	23	240	325	33
3/4 in. (19.05 mm)	185	250	25	300	410	41	425	575	58
7/8 in. (22.23 mm)	160	220	22**	445	600	60	685	930	93
1 in. (25.40 mm)	250	340	34**	670	900	90	1030	1400	140

\*The types of bolts and cap screws are identified by head markings as follows:

Plain Head: regular machine bolts and cap screws.

3-Dash Head: tempered steel high-strength bolts and cap screws.

6-Dash Head: tempered steel extra high-strength bolts and cap screws.

\*\*Machine bolts and cap screws 7/8-inch and larger are sometimes formed hot rather than cold, which accounts for the lower torque.



## Group 20 LUBRICATION

Effective use of lubricating oils and greases is perhaps the most important step toward low upkeep cost, long tractor life, and satisfactory service. Use only lubricants specified in this section. Apply them at intervals and according to the instructions in the lubrication and periodic service section.

### ENGINE LUBRICATING OILS



We recommend John Deere Torq-Gard Supreme engine oil for use in the engine crankcase. Torq-Gard oil is compounded specifically for use in John Deere engines and provide superior lubrication under all conditions. NEVER PUT ADDITIVES IN THE CRANKCASE. Torq-Gard oil was formulated to provide all the protection your engine needs. Additives could reduce this protection rather than help it.

If Torq-Gard Supreme is NOT USED, use an engine oil that conforms to one of the following specifications.

#### Single Viscosity Oils

API Service CD/SD  
 MIL-L-2104C  
 Series 3\*

#### Multi-Viscosity Oils

API Service CC/SE, CC/SD, or SD  
 MIL-L-46152

\* As further assurance of quality, the oil should also be identified as suitable for API service designation SD.

Depending on the expected atmospheric temperature at start for the fill period, use oil of viscosity as shown in the following chart.

Some increase in oil consumption may be expected when SAE 5W-20 or SAE 5W oils are used. Check oil level more frequently.

Air Temperature	John Deere Torq-Gard Supreme Oil	Other Oils	
		Single Viscosity Oil	Multi-Viscosity Oil
Above 32°F (0°C)	SAE 30	SAE 30	Not recommended
-10 to 32°F** (-23 to 0°C)	SAE 10W-20	SAE 10W	10W-30
Below -10°F (-23°C)	SAE 5W-20	SAE 5W	SAE 5W-20

\*\*If air temperature is below 10°F (-12°C), use an engine heater. SAE 5W-20 oils may also be used to insure optimum lubrication of engine and turbocharger.

### TRANSMISSION-HYDRAULIC OILS

Use only John Deere Hy-Gard Transmission and Hydraulic Oil or its equivalent in the transmission-hydraulic system. Other types of oil will not give satisfactory service and may result in eventual damage. This special oil, available from your John Deere dealer, may be used in all weather conditions.

### GREASES

Use John Deere Multi-Purpose Lubricant or an equivalent SAE multipurpose-type grease for all grease fittings. Wheel bearing grease is recommended for front wheel bearings. Application of grease as instructed in the lubrication section will provide proper lubrication and will prevent bearing contamination.

### GEAR LUBRICANTS

Use John Deere Gear Lubricant or an equivalent SCL Multipurpose-Type gear oil meeting API designation GL-4 in the Hi-Crop final drive housing.

### STORING LUBRICANTS

Your tractor can operate at top efficiency only if clean lubricants are used. Use clean containers to handle all lubricants. Store them in an area protected from dust, moisture, and other contamination.

### GENERAL INFORMATION

Carefully written and illustrated instructions are included in the tractor operator's manual. Remind your customer to follow the recommendations in these instructions.

For your convenience when servicing the tractor, the following chart shows capacities and types of lubricants for the various components.

Component	Capacity	Type of Lubricant	Interval of Service
Engine Crankcase	17 U.S. quarts (16 l) (includes filter)	See "Engine Lubricating Oils" on page 20-1	10 Hours—Check level 100 Hours—Change oil 200 Hours—Replace filter 200 Hours—Clean breather filter
Transmission and Hydraulic System	See page 5-2	John Deere Hy-Gard Transmission and Hydraulic Oil	200 Hours—Check level 200 Hours—Change filter on Perma-Clutch tractors 600 Hours—Replace filter on Power Shift tractors 1200 Hours—Change oil 1200 Hours—Clean main pump screen
Hi-Crop Final Drive Housings	2 U.S. quarts (2 l)	Above 32°F (0°C), use John Deere SAE 90 Gear Lubricant or its equivalent; below 32°F (0°C), use John Deere SAE 80 Gear Lubricant or its equivalent	200 Hours—Check level 1200 Hours—Change oil
Front Wheel Bearings	.....	Wheel Bearing Grease	1200 Hours—Repack bearings
Grease Fittings	.....	John Deere Multipurpose Lubricant	See pages 6 through 8

### ENGINE CRANKCASE

#### Checking Oil Level

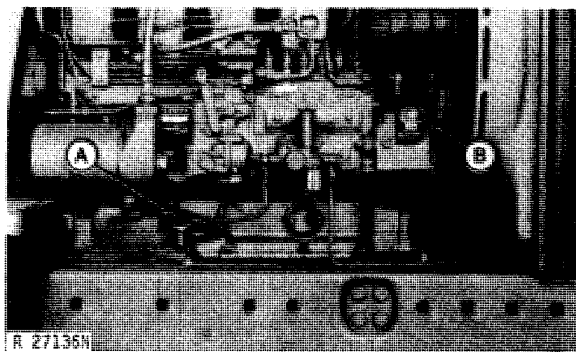

A—Dipstick

B—Filler Cap

Fig. 1-Crankcase Dipstick and Filler Cap

With the tractor on level ground and the engine stopped for 10 minutes or more, loosen the dipstick and remove it. Observe the engine oil level on the dipstick, with the dipstick seated evenly. If the oil level is down to the lower marks on the dipstick, add sufficient John Deere Torq-Gard Supreme Engine Oil or its equivalent of the proper viscosity to bring the level to the upper marks.

**SERVICE INTERVAL:** At predelivery and after every 10 hours.

## Changing Oil and Filter

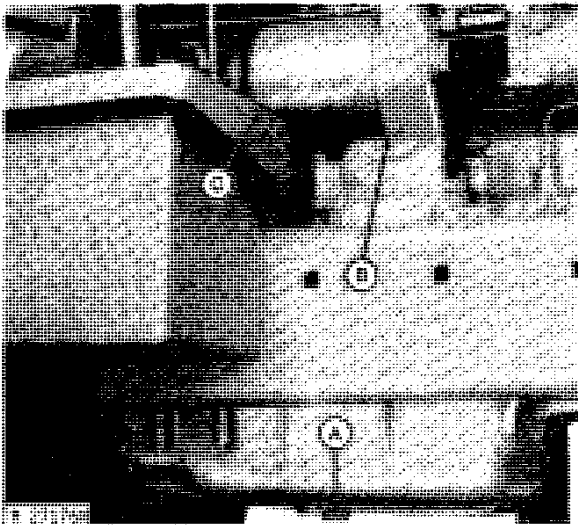

A—Crankcase Drain Plug      C—Filter Element  
B—Filter Drain Plug

Fig. 2-Crankcase Drain Plug

With the engine warm, remove the crankcase drain plug (A, Fig. 2) and drain the oil from the crankcase. Also remove the oil filter drain plug (B) and drain the filter.

Install the drain plugs and add new John Deere Torq-Gard Engine Oil or its equivalent of the proper viscosity (page 1). Run the engine at slow idle speed. Check for leaks around the crankcase drain plug. Retighten if necessary. The oil level on the dipstick 10 minutes after stopping should be at the upper marks. The capacity is 17 U.S. quarts (16 l).

**Keep a record of all oil and filter changes on the stickers that come with the filters.**

SERVICE INTERVAL: Every 100 hours.

While draining the crankcase oil, change the crankcase oil filter (C). Remove the filter element by turning it counterclockwise. Clean the filter mounting pad. Install new sealing ring. Apply a thin film of oil to the sealing ring and screw the new element in place by hand until it is tight. Engine crankcase oil capacity with filter change is 17 U.S. quarts (16 l).

**IMPORTANT: The element does not have a bypass valve. Replace only with a genuine John Deere filter element.**

SERVICE INTERVAL: Every 200 hours.

## TRANSMISSION AND HYDRAULIC SYSTEM

### Checking Oil Level

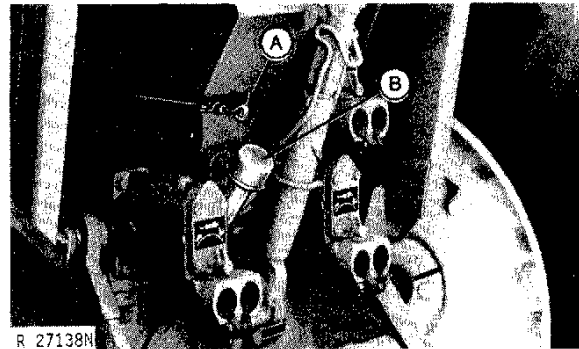

A—Dipstick      B—Filler Cap

Fig. 3-Transmission-Hydraulic System Dipstick

With the tractor on level ground, run the engine for a minute to fill the filter. Stop the engine and check the transmission-hydraulic system oil level with the dipstick. If the oil level is down to the "ADD" mark at the bottom of the "SAFE" range on the dipstick, remove the filler cap and add John Deere Hy-Gard Transmission and Hydraulic Oil or its equivalent to bring the oil level up to the top of the "SAFE" range.

SERVICE INTERVAL: At predelivery and every 200 hours.

### Changing Filter Elements

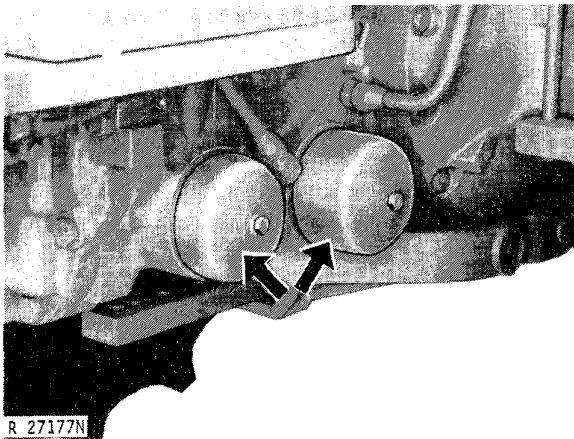

Fig. 4-Transmission-Hydraulic Filter Covers  
(Power Shift Shown)

With engine stopped, remove transmission-hydraulic system oil filter cover. On tractors with Power Shift transmission, remove both covers.

Replace filter element or elements. Replace cover gasket. Replace cover and tighten to 45 ft-lbs (60 Nm) (6 kgm).

*NOTE: Newer filter elements have a seal at each end and do not require a packing between element and retainer.*

**SERVICE INTERVAL:** After the first 100 hours. Then every 200 hours on all except Power Shift. Every 600 hours on Power Shift.

### Changing Oil

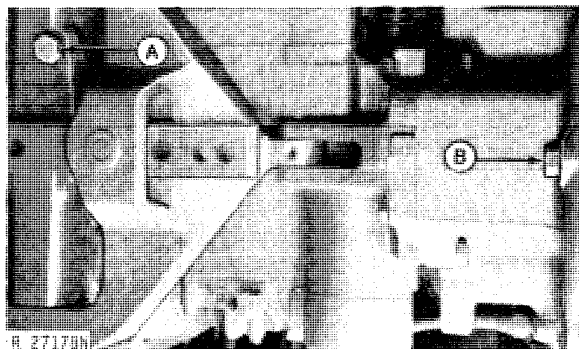

A—Transmission Case Drain Plug  
B—Clutch Housing Drain Plug

Fig. 5-Transmission-Hydraulic System Drain Plugs

With the engine warm, remove the transmission case drain plug (A, Fig. 5). On all except Power Shift, also remove clutch housing drain plug (B).

Reinstall plugs and fill system with John Deere Hy-Gard Transmission and Hydraulic Oil or its equivalent. Capacities are listed below.

#### Transmission-hydraulic system—drain and fill\*

4430 Syncro-Range . . . . .	11 U.S. gals. (42 l)
4430 Quad-Range . . . . .	11 U.S. gals. (42 l)
4430 Power Shift . . . . .	10 U.S. gals. (38 l)
4630 Syncro-Range . . . . .	21 U.S. gals. (80 l)
4630 Quad-Range . . . . .	21 U.S. gals. (80 l)
4630 Power Shift . . . . .	12 U.S. gals. (46 l)

\*Add 3 to 6 gals. if transmission is disassembled and all oil removed. Add 5 gals. (19 l) if equipped with power front-wheel drive.

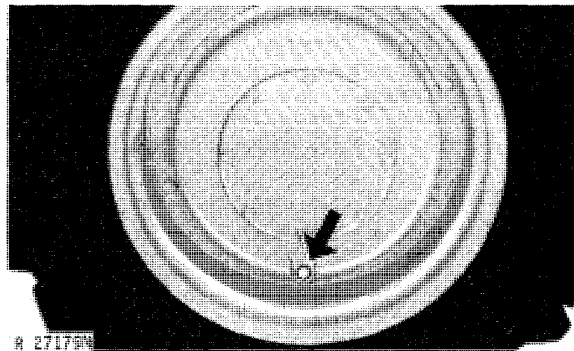
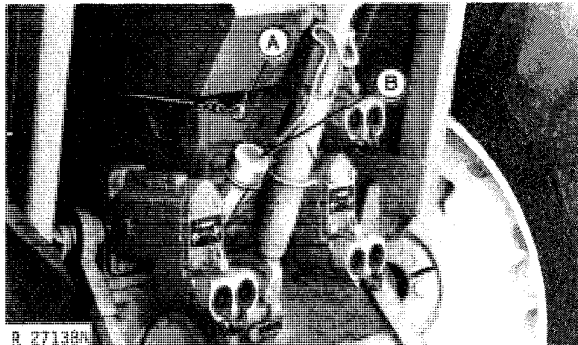

Fig. 6-Power Front-Wheel Drive Drain Plug

On Power Front-Wheel Drive tractors, position the drain plug on the wheel at the bottom, clean the area around the plug, protect the tire, and drain each wheel housing. Position the drain hole near the top and put 2 quarts (2 l) of John Deere Hy-Gard Transmission and Hydraulic Oil or its equivalent in each front wheel. Install the drain plugs. With transmission oil level at the top of the "SAFE" range, add 2 extra gallons (8 l) to transmission. Operate the front drive for 2 or 3 hours and ADD oil to the transmission to bring it to the proper level. The front wheels hold approximately 2-1/4 gallons (9 l) each.

**SERVICE INTERVAL:** Every 1200 hours.

### Cleaning Breather Filter and Main Pump Screen



A—Dipstick

B—Filler Cap

Fig. 7-Transmission-Hydraulic System Filler Cap

Remove transmission-hydraulic system filler cap. Wash breather filter in solvent, and blow it dry with compressed air.

SERVICE INTERVAL: Every 200 hours.

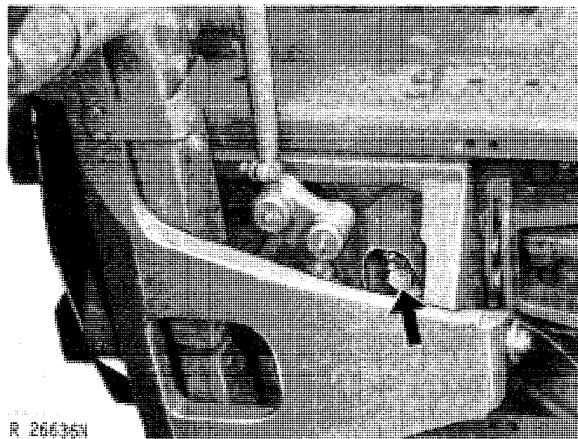

Fig. 8-Main Hydraulic Pump Screen

Remove plug (Fig. 8) from bottom of main hydraulic pump, and remove screen from hole. Wash screen in solvent, and blow it dry with compressed air. Reinstall screen and plug.

SERVICE INTERVAL: Every 1200 hours.

### HI-CROP FINAL DRIVE HOUSINGS

#### Checking Oil Level

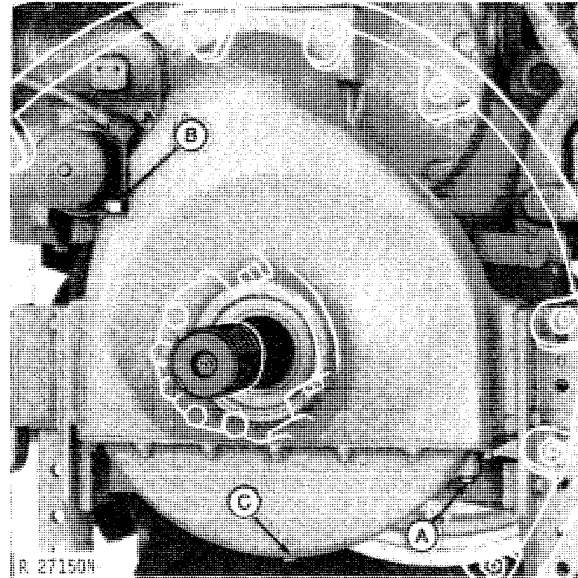

A—Oil Level Plug

C—Drain Plug

B—Filler Plug

Fig. 9-Hi-Crop Final Drive Housing

Remove oil level plug (A, Fig. 9) from each final drive housing and check oil level. If low, add gear lubricant at filler plug (B). Use John Deere Gear Lubricant or its equivalent. Use SAE 90 at temperatures above 32°F (0°C) and SAE 80 at temperatures below 32°F (0°C).

SERVICE INTERVAL: Every 200 hours.

#### Changing Oil

Remove drain plug (C, Fig. 9) from each final drive housing and drain oil. Replace drain plugs and remove filler plugs. Add 2 U.S. quarts (2 l) of John Deere Gear Lubricant or its equivalent to each housing. Use SAE 90 at temperatures above 32°F (0°C) and SAE 80 at temperatures below 32°F (0°C).

SERVICE INTERVAL: Every 1200 hours.

## FRONT WHEEL BEARINGS

### Cleaning and Packing Bearings

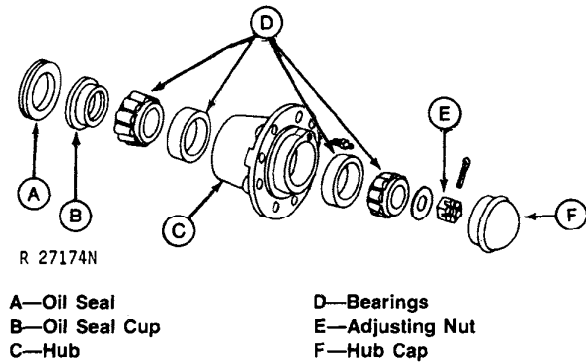

Fig. 10-Front Wheel Bearings

1. Jack up front axle.
2. Remove hub cap. Remove cotter pin and adjusting nut.
3. Disassemble parts. Clean parts in solvent and blow them dry with compressed air.
4. Inspect parts carefully for damage. Replace bearings if they are worn. Replace oil seal and oil seal cup if three deep grooves are worn in cup.
5. Pack bearings with wheel bearing grease. Coat seal with John Deere Multipurpose Lubricant or its equivalent.
6. Reassemble parts. Tighten adjusting nut until a slight drag is felt when wheel is turned. Back nut off just enough to insert cotter pin in first hole.
7. Reinstall hub cap.

SERVICE INTERVAL: Every 1200 hours.

## GREASE FITTINGS

### Lubricating Front Axle

If tractor has a wide front axle, apply several shots of John Deere Multi-Purpose Lubricant or its equivalent to tie rods, the pivot pins, and the steering spindles (10 fittings). On Hi-Crop tractors with radius rods, also apply several shots of grease to the radius rod pivot grease fitting.

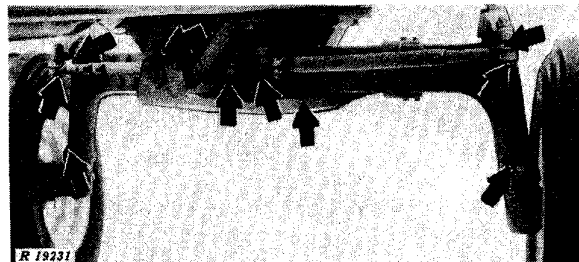

Fig. 11-Wide Front Axle Grease Fittings

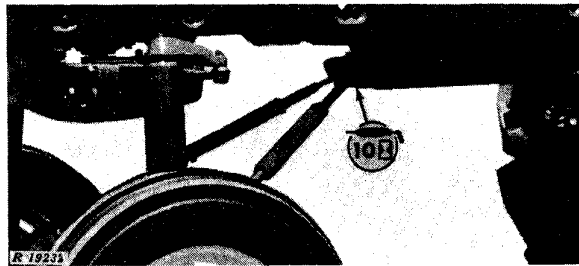

Fig. 12-Radius Rod Pivot Grease Fitting

SERVICE INTERVAL: At predelivery and every 10 hours.

### Lubricating Wide-Swing Drawbar

If the tractor has a wide-swing drawbar, apply several shots of John Deere Multi-Purpose Lubricant or its equivalent to the drawbar rollers.

SERVICE INTERVAL: At predelivery and every 10 hours.

### Lubricating Hi-Crop Rear Axles

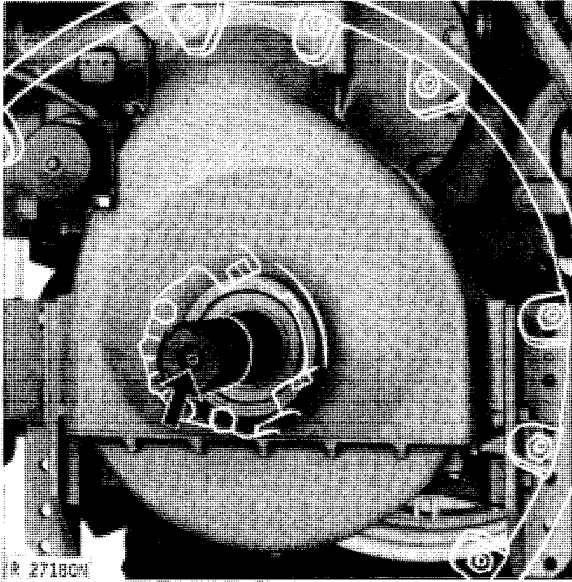

Fig. 13-Hi-Crop Rear Axle Grease Fitting

On Hi-Crop tractors, apply several shots of John Deere Multi-Purpose Lubricant or its equivalent to the grease fittings on the ends of the rear axles.

**SERVICE INTERVAL:** At predelivery and every 10 hours.

### Lubricating Front Wheels

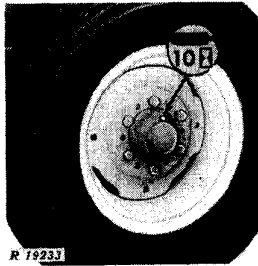

Fig. 14-Front Wheel Grease Fitting

When the tractor is being operated in extremely wet and muddy conditions, grease each front wheel (except Power Front-Wheel Drive) daily or every 10 hours. To do so, remove the pipe plugs, install fittings, and apply several shots of John Deere Multi-Purpose Lubricant or its equivalent. CONTINUE lubricating the front wheels at this interval until the bearings can be cleaned and packed with wheel bearing grease.

**SERVICE INTERVAL:** Only if tractor is operated in extremely wet and muddy conditions, lubricate every 10 hours until bearings can be cleaned and packed as instructed on page 6.

### Lubricating Rear Axle Bearings

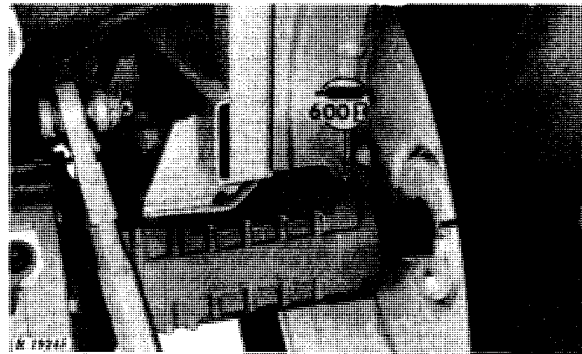

Fig. 15-Rear Axle Grease Plug

Grease the rear axle bearings by removing the pipe plug on each end of the axle housing, installing a grease fitting, and applying John Deere Multi-Purpose Lubricant or its equivalent at each fitting until grease appears at the axle seals. (If rear wheel weights obscure rear axle seal, apply a maximum of 25 shots of grease.)

**SERVICE INTERVAL:** At predelivery and every 600 hours. If tractor is operated in extremely wet and muddy conditions, lubricate every 10 hours.

## Lubricating 3-Point Hitch

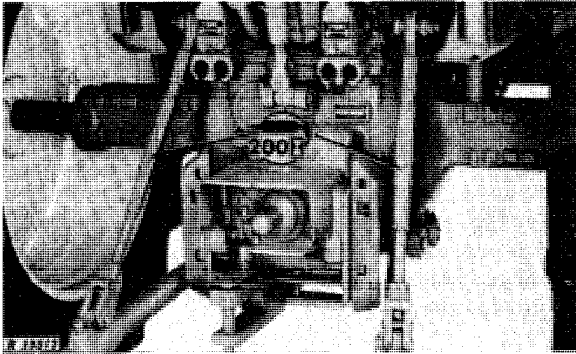

Fig. 16-3-Point Hitch Grease Fittings

Grease the 3-point hitch by applying 3 or 4 shots of John Deere Multi-Purpose Lubricant or its equivalent at each fitting.

**SERVICE INTERVAL:** At predelivery and every 200 hours.

**NOTE:** On tractors with a Power Shift transmission, the Sound-Gard Body can be removed with the control support to facilitate service of the rear clutch pack, planetary, and PTO gear train. The control support need not be removed with the Sound-Gard Body when servicing components of Quad-Range and Syncro-Range transmissions.

### REMOVING SOUND-GARD BODY WITHOUT CONTROL SUPPORT

#### Special Tools

The following items, or their equivalents, are recommended when performing this job. For increased efficiency, gather them together before beginning the job.

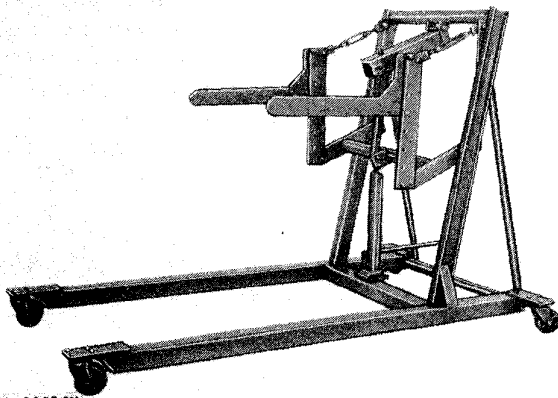

R 26614N

Fig. 1-Brown Body Lift\*

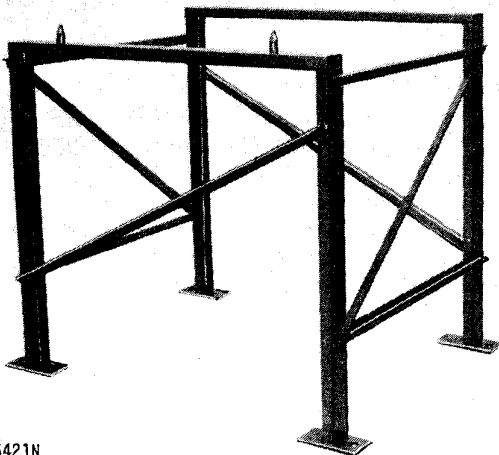

R 26421N

Fig. 2-JDG-10-2 Support Stand\*\*

\*Brown Tractor Co.  
Bonham, Texas 75418

\*\*Service Tools  
Box 314, Owatonna, MN 55060

## Group 25 SEPARATION

### Removal

1. (Not Illustrated) Disconnect battery ground cable.
2. (Not Illustrated) On tractors equipped with a heater, drain the cooling system.

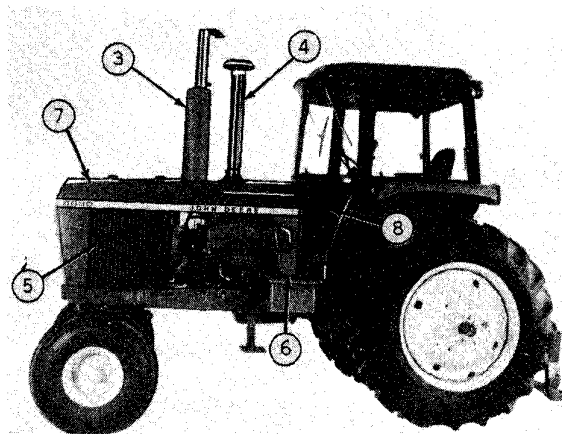

R 26615N

Fig. 3-Removing Muffler, Screens and Cowling

3. Remove muffler.
4. Remove air intake stack (4630).
5. Remove left and right-hand grille screens.
6. Remove left and right-hand side shields.
7. Remove hood.
8. Remove left and right-hand cowling.
9. (Not Illustrated) Remove floor mat.

### Removal—Continued

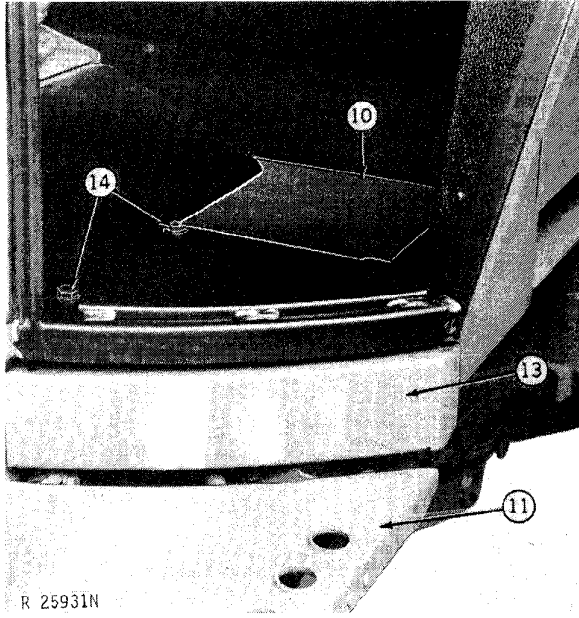
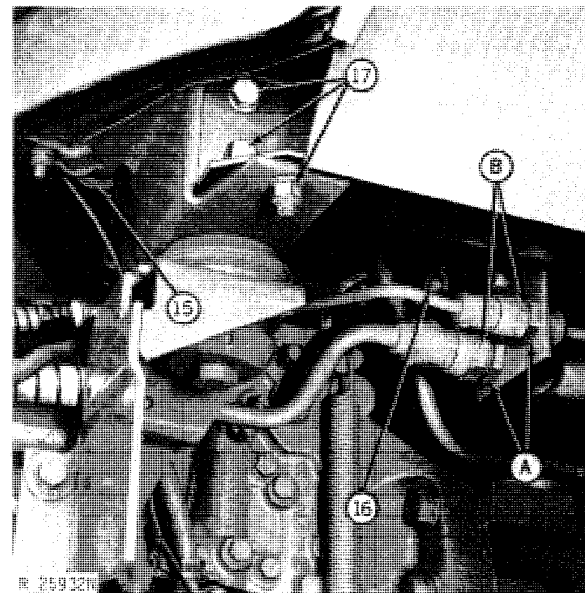

Fig. 4-Removing Battery Box Covers and Cap Screws

10. Remove left and right-hand cab floor filler panels.
11. Remove left and right-hand battery box covers.
12. (Not Illustrated) Remove batteries and battery boxes.
13. Remove left and right-hand riser panels.
14. Remove Sound-Gard Body-to-control support cap screws.



A—Coupler Body                      B—Coupler

Fig. 5-Disconnecting Couplers and Wiring

15. Disconnect left-hand wiring lead. (Connector is located under control support.)

16. Remove control support-to-Sound-Gard Body cap screws (left and right-hand sides).

17. Remove Sound-Gard Body-to-control support bracket cap screws (left and right-hand sides).

**⚠ CAUTION:** Follow safety precautions when working with the air conditioning system:

Refrigerant-12 by itself is harmless and non-poisonous; however, special precautions should be taken when servicing any refrigerant air conditioning system or handling refrigerant containers.

(a) Do not expose eyes or skin to liquid refrigerant. Always wear safety goggles when opening refrigerant lines. Liquid Refrigerant-12 has a boiling temperature of approximately  $-21^{\circ}\text{F}$  ( $-29^{\circ}\text{C}$ ) at seal level; therefore, serious injury could result if liquid refrigerant contacts the eye or skin. If Refrigerant-12 strikes the eye, call a doctor IMMEDIATELY and:

Do not rub the eye. Splash cold water on the eye to gradually raise the temperature of the contacted area.

Obtain treatment from a physician as soon as possible.

If the liquid refrigerant comes in contact with the skin, treat the injury as though it were frozen or frostbitten.

(b) Do not discharge refrigerant into an area where there is exposed flame. Heavy concentrations of refrigerant-12 contacting an open flame will produce a poisonous gas.

(c) Do not weld or steam clean near or on an air conditioning system. Excessive pressure could be built-up within the system.

(d) Before loosening a refrigerant fitting, cover the connection with a cloth.

**IMPORTANT:** Keep ends of couplers clean to prevent possible contamination of system.

18. Disconnect refrigerant couplers on tractors with air conditioning.

*NOTE:* Disconnect couplers by holding the coupler body (A, Fig. 5) stationary with a wrench and unscrewing coupler (B) with another wrench. If refrigerant can be heard escaping as coupler is loosened, retighten coupler and loosen again.

19. (Not Illustrated) Remove clamp on high pressure refrigerant line located near refrigerant couplers.

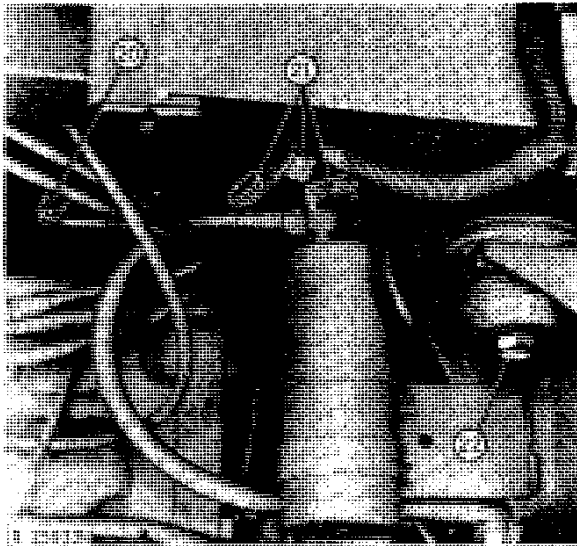

Fig. 6-Disconnecting Speed Control Rod and Cap Screws

20. Disconnect speed control rod from inner arm.

21. Disconnect Sound-Gard Body wiring.

22. Remove Sound-Gard Body mounting cap screws (left- and right-hand sides).

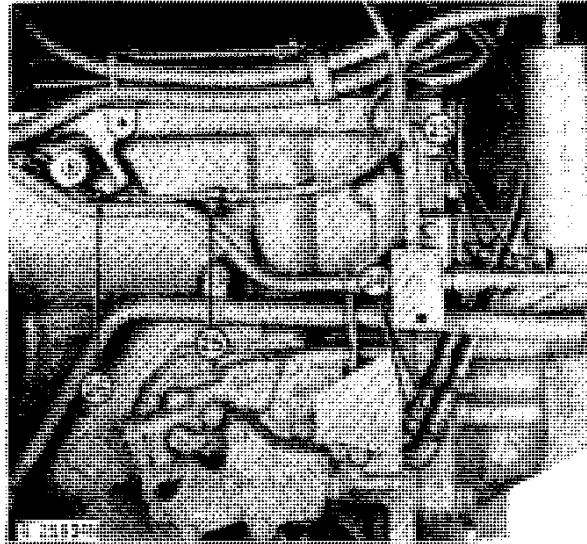

Fig. 7-Disconnecting Shifter Control Cables

23. Remove transmission control cable clamps. (Power Shift transmission.)

24. Disconnect transmission control cables from control valve arms.

25. Remove transmission lock control cable clamp. (Power Shift transmission.)

26. Disconnect transmission lock cable from spring.

*NOTE:* On tractors with a Quad-Range transmission and Power Front-Wheel Drive, disconnect electrical connector located under shifter controls. On tractors with Power Shift transmission and Power Front-Wheel Drive, disconnect wiring from switches on transmission.

## Removal—Continued

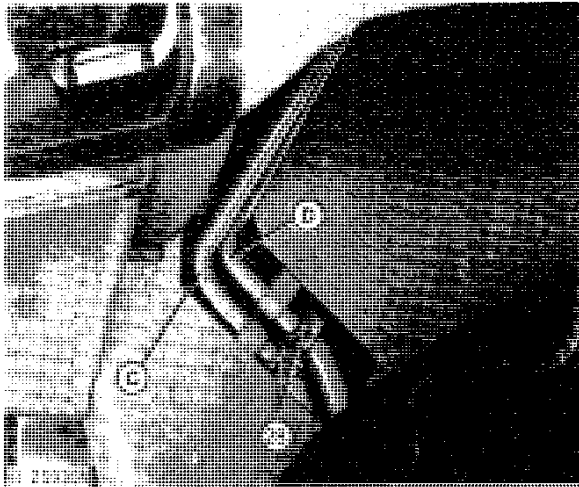

C—Supply Pipe

D—Return Pipe

Fig. 8-Disconnecting Heater Hoses

27. (Not Illustrated) Remove heater hose-to-body clamps (located inside of right-hand fender well).

*NOTE: Identify supply and return hoses for proper installation (Fig. 8).*

28. Disconnect heater hoses.

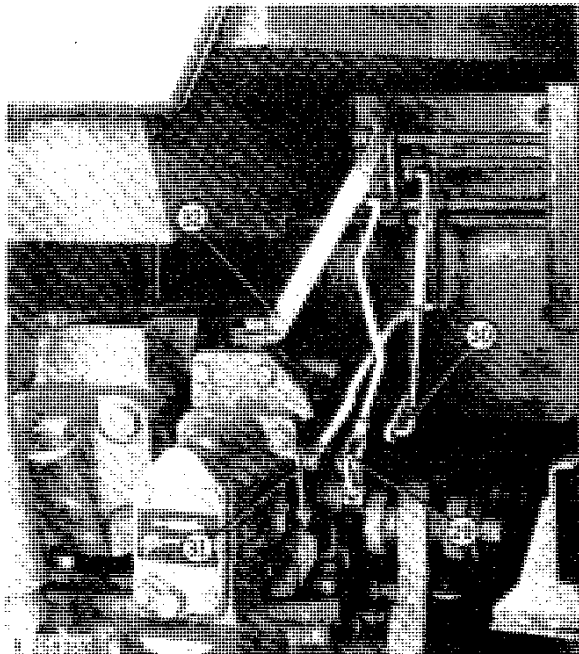

Fig. 9-Disconnecting Control Linkage

29. Disconnect rockshaft operating rod from control arm on rockshaft.

30. Disconnect load selective control valve rod from control arm on rockshaft.

31. Disconnect selective control valve rods from operating arms at selective control valve.

32. Disconnect Sound-Gard Body link from top of rockshaft control valve housing.

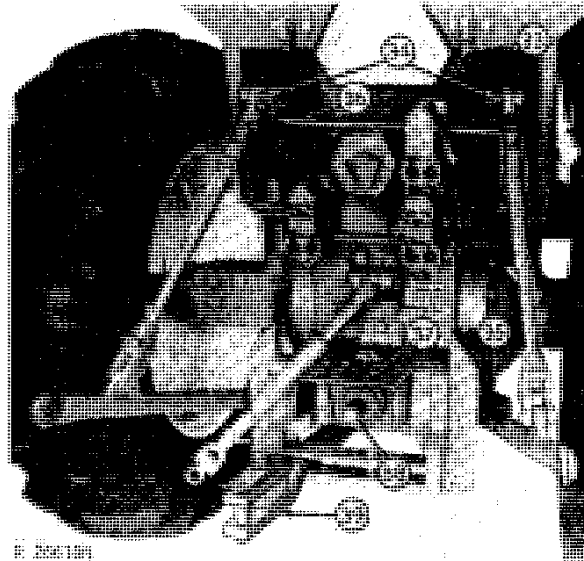

Fig. 10-Securing Control Rods

33. Wire selective control valve rods and rockshaft control rods to remote cylinder transport bracket.

34. Disconnect both lift links from rockshaft lift arms.

35. Remove both draft links from draft link support.

36. Secure rockshaft lift arms in the up position.

37. Remove PTO master shield.

38. Remove rear PTO guard.

39. Move drawbar to far left or far right position.

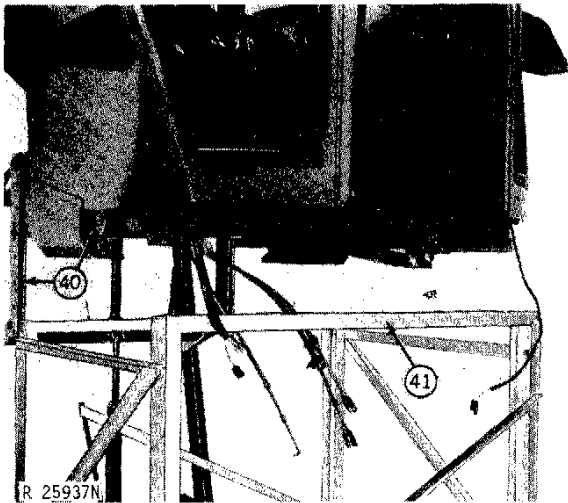

Fig. 11-Placing Sound-Gard Body On Support Stand

40. Move Brown Body Lift into position, and carefully lift off Sound-Gard Body.

41. Place Sound-Gard Body on JDG-10-2 Support Stand.

## INSTALLATION

### Special Tools

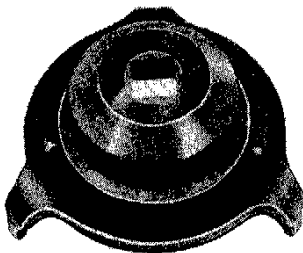

R 26423N

Fig. 12-JDG-11 Adapter\*

\*Service Tools Inc.,  
 Box 314, Owatonna, MN 55060

## Assembly

Reverse the removal steps given on the previous pages and note the special installation instructions which follow.

1. (Not Illustrated) Before installing body, be sure rubber seal that contacts the control support is in place and is in good condition.

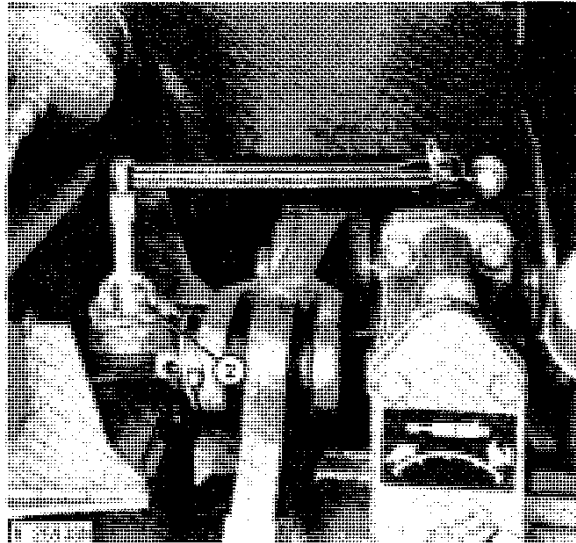

Fig. 13-Installing Retaining Caps

2. Use JDG-11 Adapter on Sound-Gard Body retaining caps and tighten to the following specifications:

#### Retaining Cap Torque Specifications

9 to 11 ft-lbs (12 to 15 Nm) (1.2 to 1.5 kgm)\*  
 15 to 25 ft-lbs (20 to 34 Nm) (2 to 3.4 kgm)\*\*

4430	4630
*( -T041550)	*( -T015402)
**(T041551- )	**(T015403- )

**IMPORTANT: Do not over-torque front cap screw on rear mount. Doing so may deform the special washer and crush the spacer.**

3. Tighten the front cap screw on rear mounts to 110 to 150 ft-lbs (149 to 203 Nm) (14.9 to 20.3 kgm).

*NOTE: Roll-Gard mounting cap screws are also tightened to the above torque.*

4. Check for leaks (p. 80-5-14) around couplers on tractors equipped with air conditioning.

## REMOVING SOUND-GARD BODY WITH CONTROL SUPPORT

### Special Tools

Brown Body-Lift (Fig. 1, p. 10-25-1)

JDG-10-2 Support Stand (Fig. 2, p. 10-25-1)

### Removal

1. (Not Illustrated) Disconnect battery ground cable.
2. (Not illustrated) On tractors equipped with a heater, drain the cooling system.

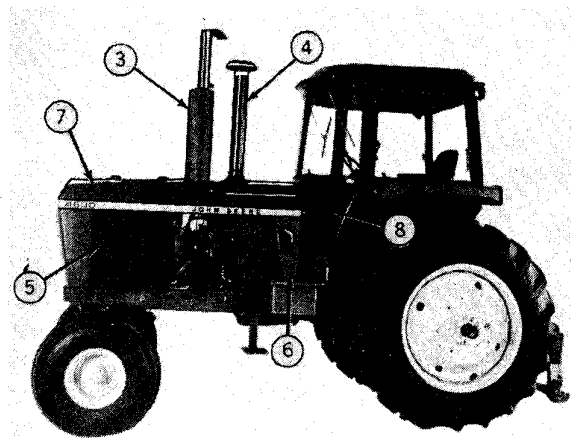

R 26615N

Fig. 14-Removing Muffler, Screens and Cowling

3. Remove muffler.
4. Remove air intake stack (4630).
5. Remove left and right-hand grill screens.
6. Remove left and right-hand side shields.
7. Remove hood.
8. Remove left and right-hand cowling.
9. (Not Illustrated) Remove floor mat.

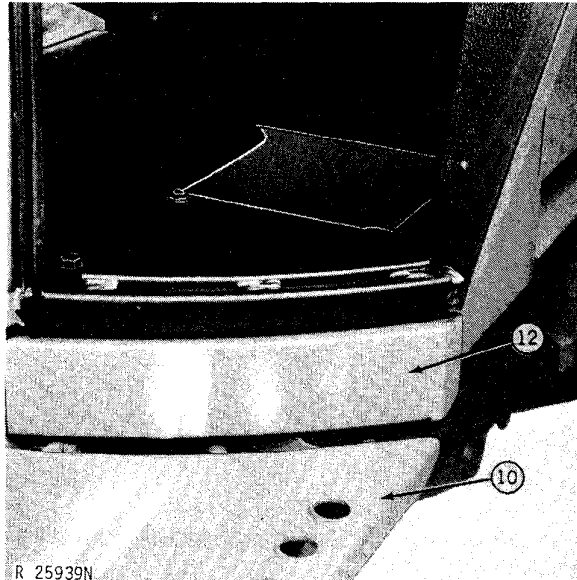

R 25939N

Fig. 15-Removing Battery Box Covers and Riser Panels

10. Remove left and right-hand battery box covers.
11. (Not Illustrated) Remove batteries and battery boxes.
12. Remove left and right-hand riser panels.

**⚠ CAUTION:** Follow all safety precautions found on page 10-25-2 when working with the air conditioning system.

**IMPORTANT:** Keep ends of couplers clean to prevent possible contamination of system.

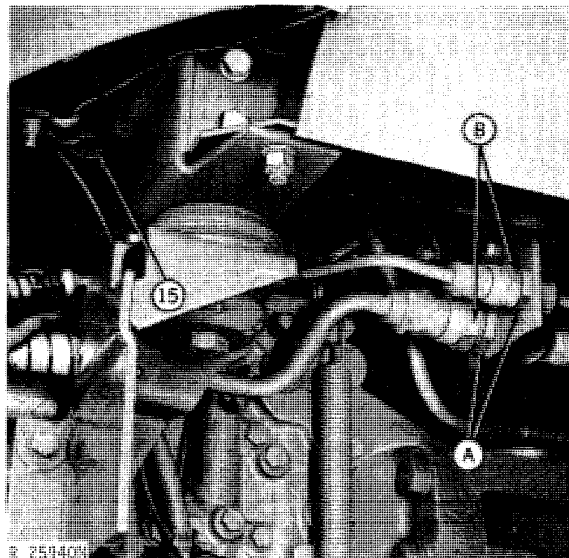

R 25940N

A—Coupler Body

B—Coupler

Fig. 16-Disconnecting Couplers and Wiring

13. Disconnect refrigerant couplers on tractors with air conditioning.

*NOTE: Disconnect couplers by holding the coupler body (A, Fig. 16) stationary with a wrench and unscrewing coupler (B) with another wrench. If refrigerant can be heard escaping as coupler is loosened, retighten coupler and loosen again.*

14. (Not Illustrated) Remove clamp on high pressure refrigerant line located near refrigerant couplers.

15. Disconnect left-hand wiring lead (under control support).

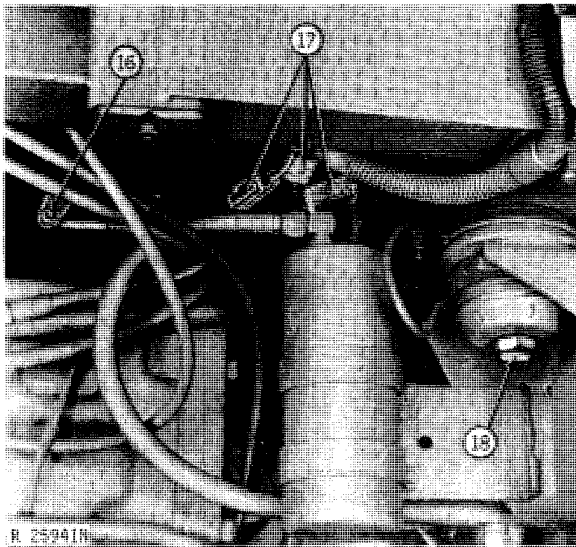

Fig. 17-Disconnecting Speed Control Rod and Cap Screws

16. Disconnect speed control rod from inner arm.

17. Disconnect Sound-Gard Body wiring.

18. Remove the Sound-Gard Body mounting cap screws (left and right sides).

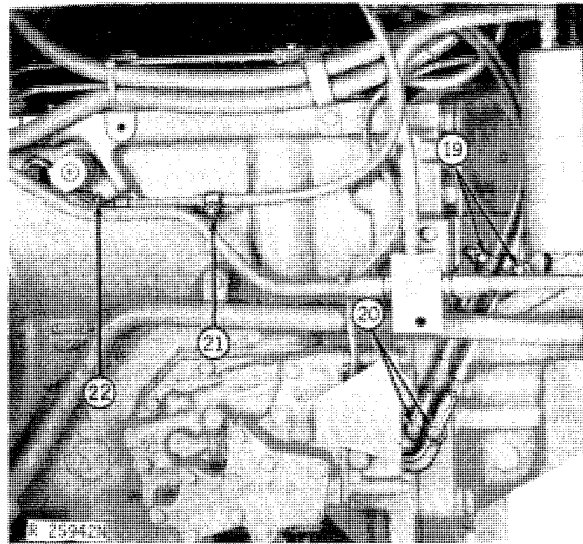

Fig. 18-Disconnecting Shifter Control Cables

19. Remove transmission control cable clamps (Power Shift).

20. Disconnect transmission control cables at control valve arms.

21. Remove transmission park lock holding clamp (Power Shift).

22. Disconnect transmission park lock cable from spring.

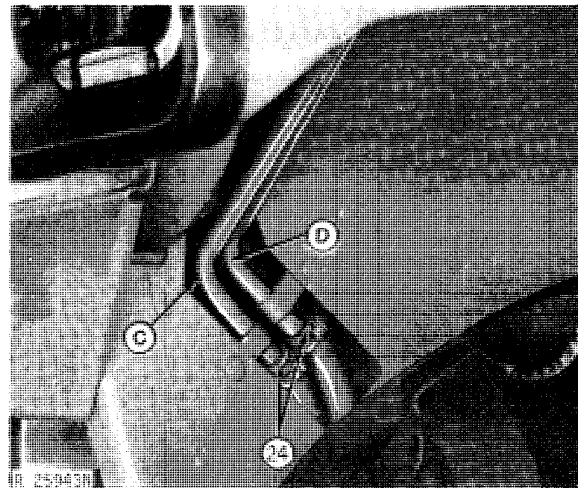

C—Supply Hose

D—Return Hose

Fig. 19-Disconnecting Heater Hoses

### Removal—Continued

23. (Not Illustrated) Remove heater hose-to-body clamps (located inside of right-hand fender well).

*NOTE: Identify supply and return hoses for proper installation (Fig. 19).*

24. Disconnect heater hoses.

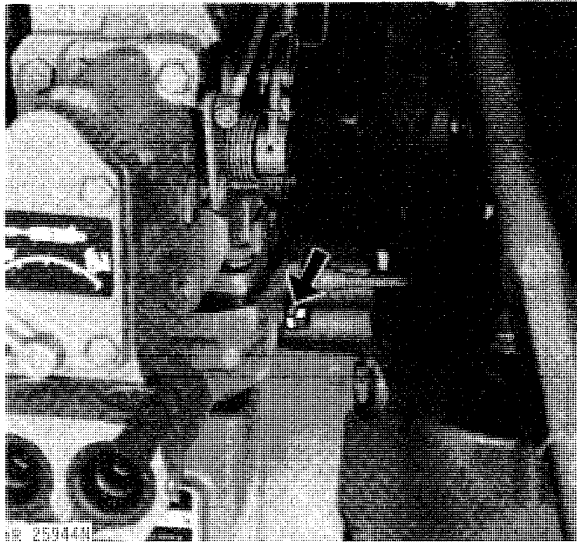

Fig. 20-Discharging Accumulator

**CAUTION:** Before disconnecting brake pressure lines, be sure that the brake accumulator is discharged.

The accumulator can be discharged by opening the right-hand brake bleed screw (Fig. 20), and holding the pedal down for a few minutes.

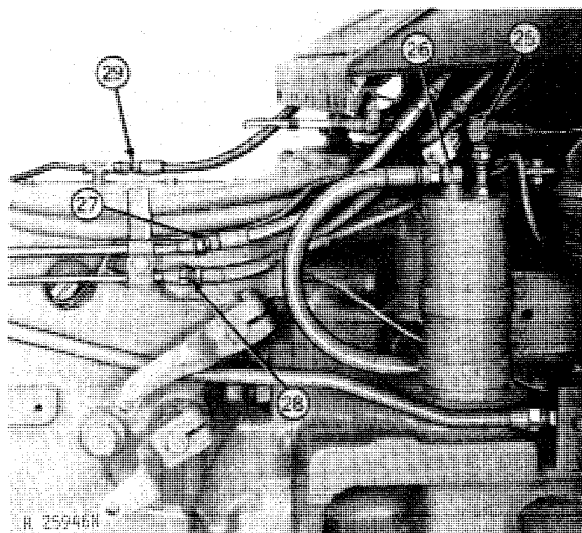

Fig. 21-Disconnecting Oil Lines (Sound-Gard Body removed for illustration purposes)

25. Disconnect brake pressure line from attenuator.
26. Disconnect brake valve return line.
27. Disconnect right-hand rear brake oil line.
28. Disconnect differential lock oil line.
29. Disconnect left-hand rear brake oil line.

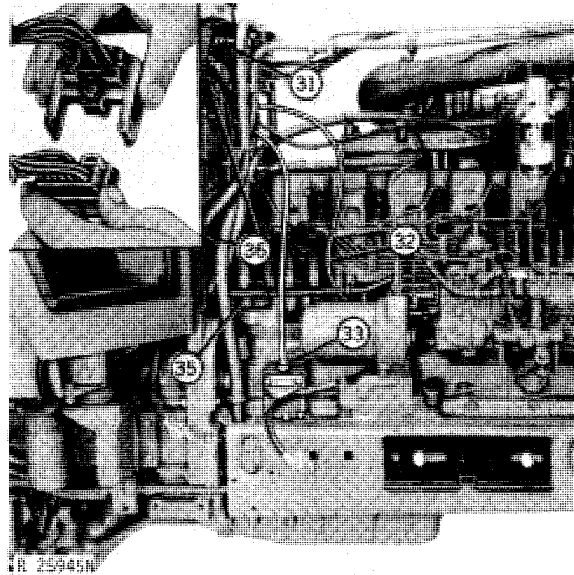

Fig. 22-Disconnecting Cables and Wiring

30. (Not Illustrated) Thoroughly clean area around steering valve.
31. Disconnect steering metering pump-to-steering valve lines from steering valve.
32. Disconnect fuel shut-off cable from injection pump.
33. Disconnect tachometer drive cable.

34. Remove speed control cable clamp (located under control support).

35. Disconnect speed control linkage at turnbuckle.

36. Remove main wiring harness connector from control support.

*NOTE: To remove connector, remove cap screw located in center of connector.*

37. (Not Illustrated) Disconnect clutch pedal rod from clutch control arm on clutch housing.

38. (Not Illustrated) Disconnect PTO operating rod from operating valve under footrest.

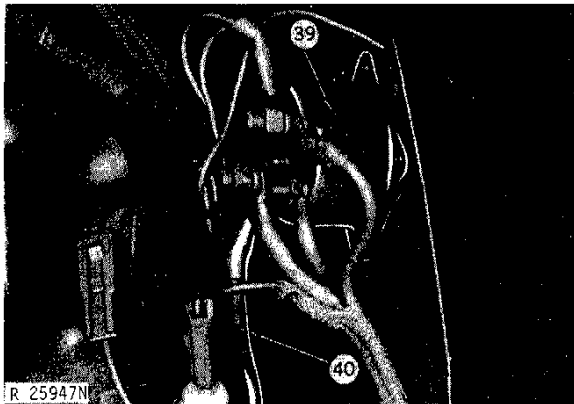

Fig. 23-Removing Starter Circuit Relay

39. Remove starter circuit relay from control support.

40. Remove cab electrical load wire from relay.

*NOTE: On tractors with Power Front-Wheel Drive, disconnect wiring from connector near starter circuit relay.*

41. (Not Illustrated) Disconnect light dimmer switch wiring from dimmer switch.

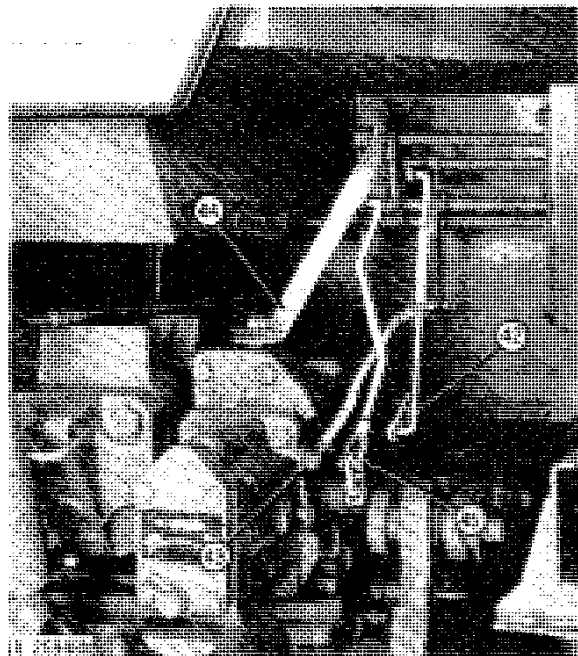

Fig. 24-Disconnecting Control Linkage

42. Disconnect load selective control rod from control arm on rockshaft.

43. Disconnect selective control valve rods from operating arms on selective control valve.

44. Disconnect Sound-Gard Body link from top of rockshaft control valve housing.

45. Disconnect rockshaft operating rod from control arm on rockshaft.

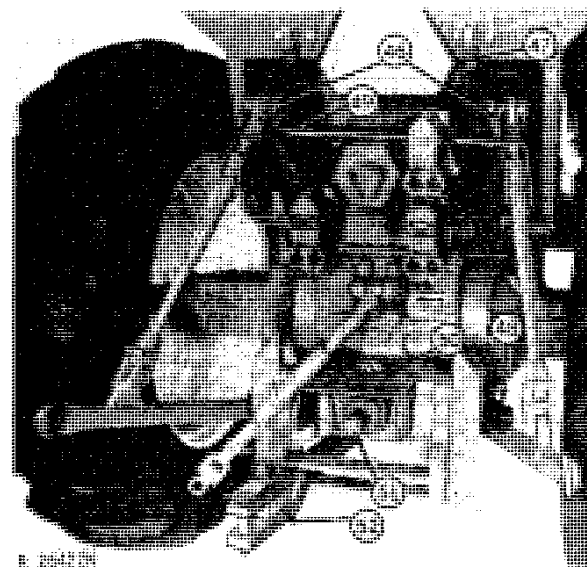
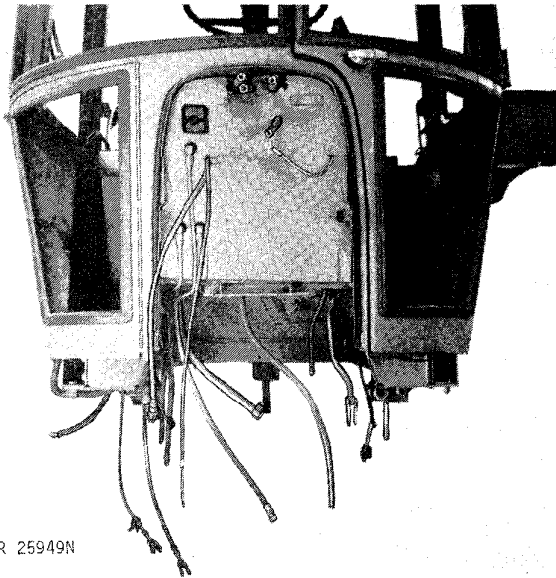

Fig. 25-Securing Control Rods

### Removal—Continued

46. Disconnect both lift links from rockshaft lift arms (4630).
47. Wire selective control valve and rockshaft control rods to remote cylinder transport bracket.
48. Remove both draft links from draft link support. (4630)
49. Secure rockshaft lift arms in the up position. (4630)
50. Remove PTO master shield.
51. Remove rear PTO guard.
52. Move drawbar to far right or far left position.



R 25949N

Fig. 26-Sound-Gard Body with Control Support

53. (Not Illustrated) Move Brown Body Lift into position.
54. Carefully lift off Sound-Gard Body with control support (Fig. 26).
55. (Not Illustrated) Place Sound-Gard Body with control support on JDG-10-2 Support Stand.

### INSTALLATION

#### Special Tools

JDG-11 Adapter (Fig. 12, p. 10-25-5)

#### Assembly

Reverse the removal steps given on the previous pages and note the special installation instructions which follow.

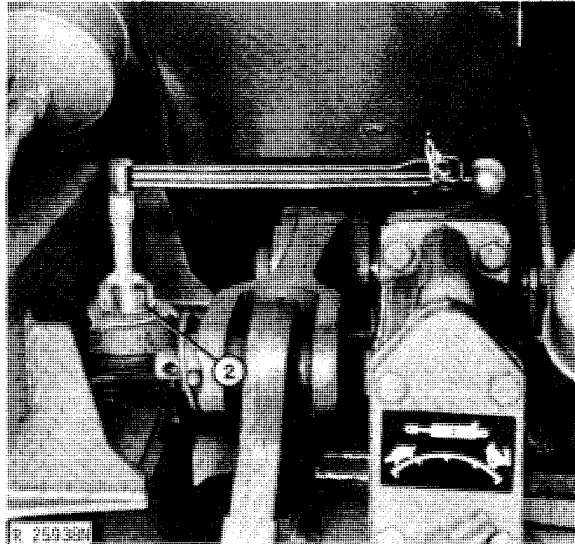

Fig. 27-Installing Retaining Caps

1. (Not Illustrated) Before installing body, be sure rubber seal that contacts the control support is in place and is in good condition.
2. Use JDG-11 Adapter on Sound-Gard Body retaining caps and tighten to the following specifications.

#### RETAINING CAP TORQUE SPECIFICATIONS

9 to 11 ft-lbs (12 to 15 Nm) (1.2 to 1.5 kgm)\*  
15 to 25 ft-lbs (20 to 34 Nm) (2 to 3.4 kgm)\*\*

4430	4630
*( -T041550)	*( -T015402)
**(T041551- )	**(T015403- )

3. Tighten the front cap screw on rear mounts to 110 to 150 ft-lbs (149 to 203 Nm) (14.9 to 20.3 kgm).

*NOTE: Roll-Gard mounting cap screws are also tightened to the above torque.*

4. (Not Illustrated) Check for leaks (p. 80-5-14) around couplers on tractors equipped with air conditioning.

5. (Not Illustrated) After installation is complete perform the following steps in bleeding the brakes:

### Bleeding The Brakes

- (a) Start the engine.
- (b) Loosen brake bleed screw lock nuts on both sides of transmission case.
- (c) Turn bleed screws out two turns.
- (d) Tighten lock nuts.
- (e) Depress brake pedals for two minutes.
- (f) While pedals are being held down, retighten the bleed screws.
- (g) Tighten the lock nuts.

### SEPARATING ENGINE FROM CLUTCH HOUSING

#### Special Tools

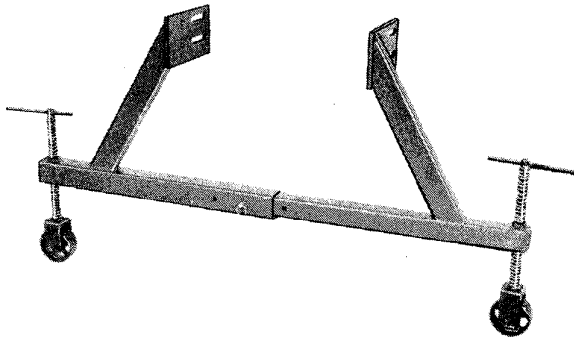

R 26619N

Fig. 28-JDG-12-1 Splitting Stand\*

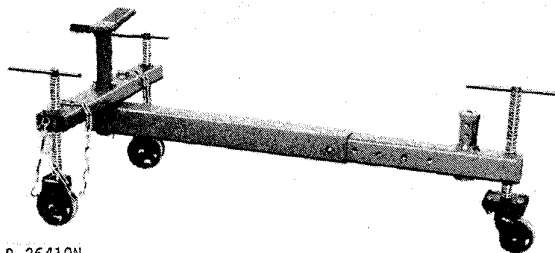

R 26419N

Fig. 29-JDG-2M Rear Splitting Stand\*

\*Service Tools  
Box 314, Owatonna MN 55060

#### Removal

**CAUTION:** Before separating tractor, be sure that the brake accumulator is discharged. The accumulator can be discharged by opening the right-hand brake bleed screw (Fig. 30), and holding the brake pedal down for a few minutes.

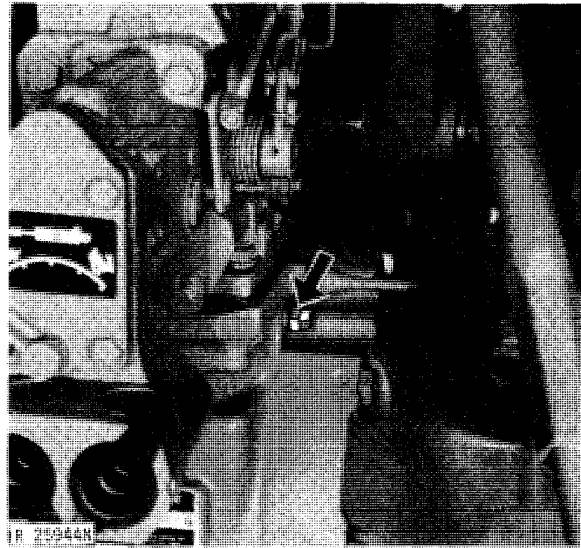

Fig. 30-Discharging Accumulator

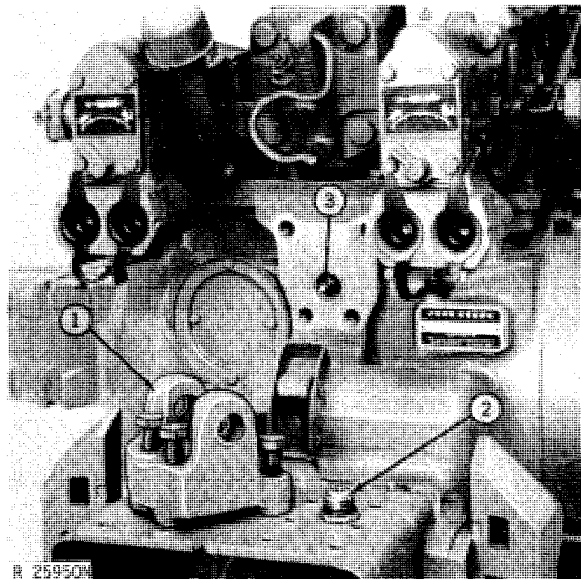

Fig. 31-Removing Transmission Pump Drive Shaft

**IMPORTANT:** On tractors with Quad-Range or Syncro-Range transmission, remove the hexagonal transmission pump drive shaft from rear of transmission case.

1. Remove center link attaching bracket.
2. Remove plug.
3. Carefully, withdraw transmission pump drive shaft.

### Removal—Continued

4. (Not Illustrated) Put tractor in the "Park" position.
5. (Not Illustrated) Disconnect battery ground cable.
6. (Not Illustrated) On tractors equipped with a heater, drain the cooling system.

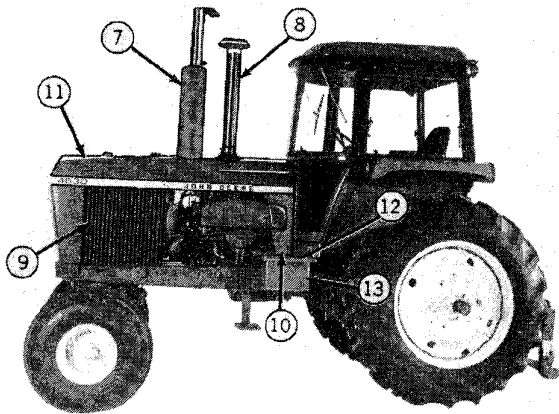

R 26616N

Fig. 32-Removing Muffler, Screens and Shields

7. Remove muffler.
8. Remove air intake stack (4630).
9. Remove left and right-hand grill screens.
10. Remove left and right-hand side shields.
11. Remove hood.
12. Remove left and right-hand battery box covers.
13. Remove batteries and battery boxes.
14. Remove main harness connector from control support.

*NOTE: To remove connector, remove cap screw located in center of connector. Remove upper half from lower half.*

15. Disconnect hydraulic oil cooler return pipe.
16. Disconnect heater return hose from top of water pump housing.
17. Disconnect hydraulic pump seal drain line at transmission.
18. Disconnect hydraulic pump pressure pipe.

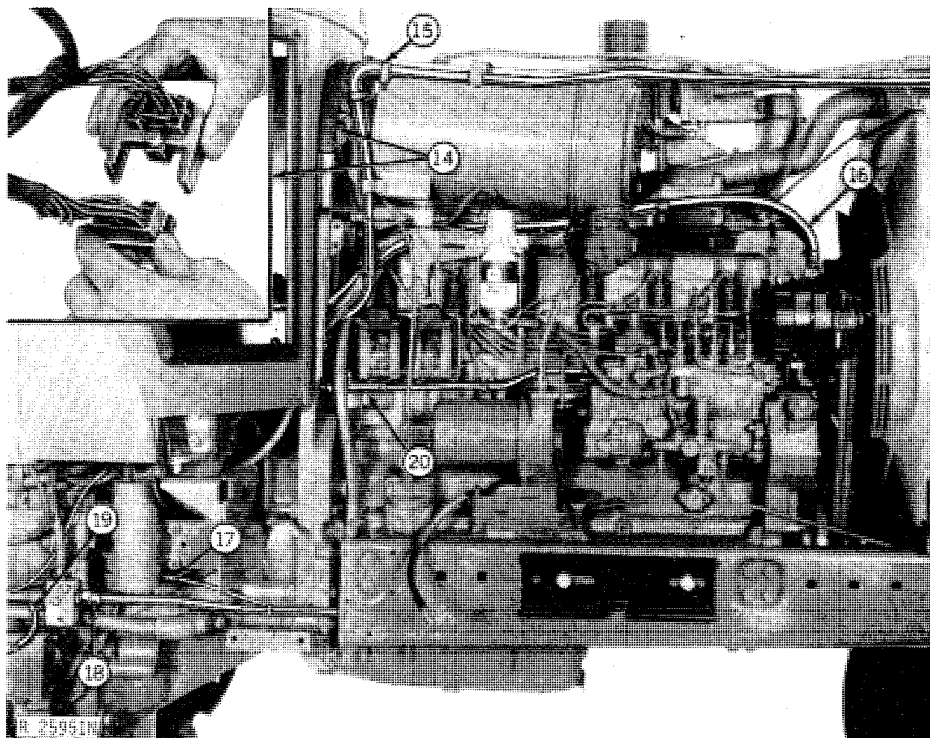

Fig. 33-Right Side Removal Procedures

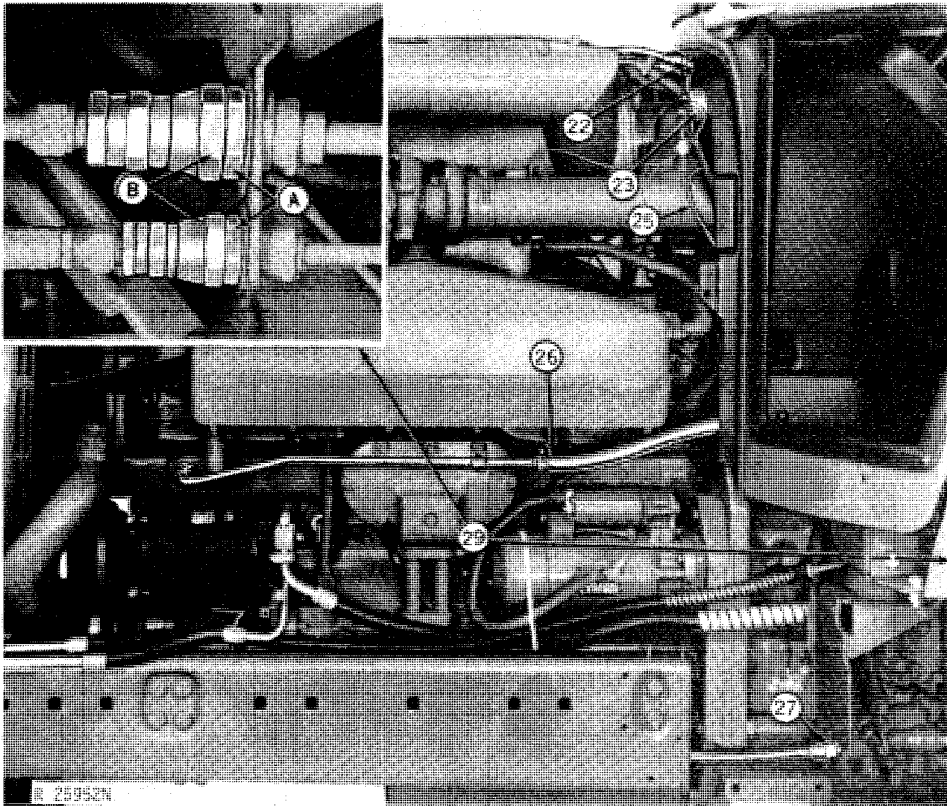

Fig. 34-Left Side Removal Procedures

19. Disconnect start-safety switch wiring from transmission.
20. Disconnect speed control rod at turnbuckle.
21. (Not Illustrated) Clean area around steering pipes at control support.
22. Disconnect steering pipes at control support.
23. Remove starting circuit relay from control support.
24. Remove cab electrical load wire from relay (40, Fig. 23).
25. Disconnect clutch pressure sending wire from connector near starting circuit relay.
26. Disconnect heater supply hose.
27. Disconnect hydraulic pump return line.
28. (Not Illustrated) On tractors with Power Front-Wheel Drive, disconnect the drain pipe.

**CAUTION:** Follow all safety precautions found on page 10-25-2 when working with the air conditioning system.

**IMPORTANT:** Keep ends of couplers clean to prevent possible contamination of system.

29. Disconnect refrigerant couplers on tractors with air conditioning.

*NOTE: Disconnect couplers by holding the coupler body (A, Fig. 34) stationary with a wrench and unscrewing coupler (B) with another wrench. If refrigerant can be heard escaping as coupler is loosened, re-tighten coupler and loosen again.*

## Removal—Continued

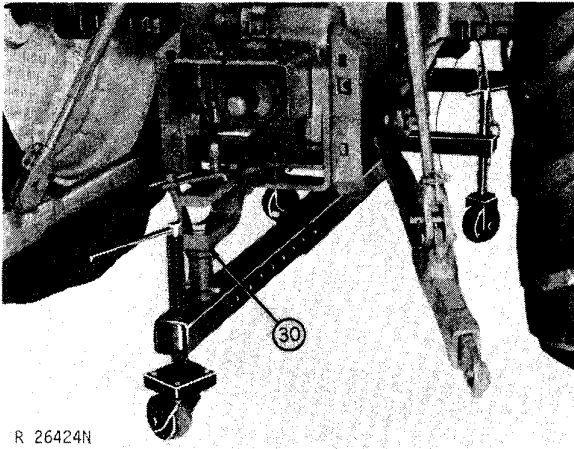

Fig. 35-Attaching JDG-2M Rear Splitting Stand

30. Attach JDG-2M Rear Splitting Stand (Fig. 35 and 36).

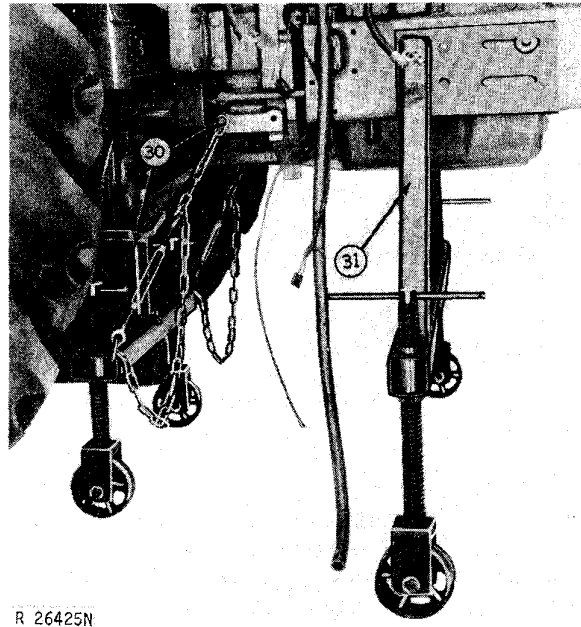

Fig. 36-Attaching JDG-12-1 Splitting Stand

31. Attach JDG-12-1 Splitting Stand to side frames.

32. (Not Illustrated) Place a drain pan under the engine-to-clutch housing parting surface on tractors with a Quad-Range or Syncro-Range transmission to catch oil from clutch housing as separation is made.

33. (Not Illustrated) Remove oil pan-to-clutch housing cap screws.

34. (Not Illustrated) Remove clutch housing-to-engine cap screws.

35. (Not Illustrated) Separate engine from clutch housing.

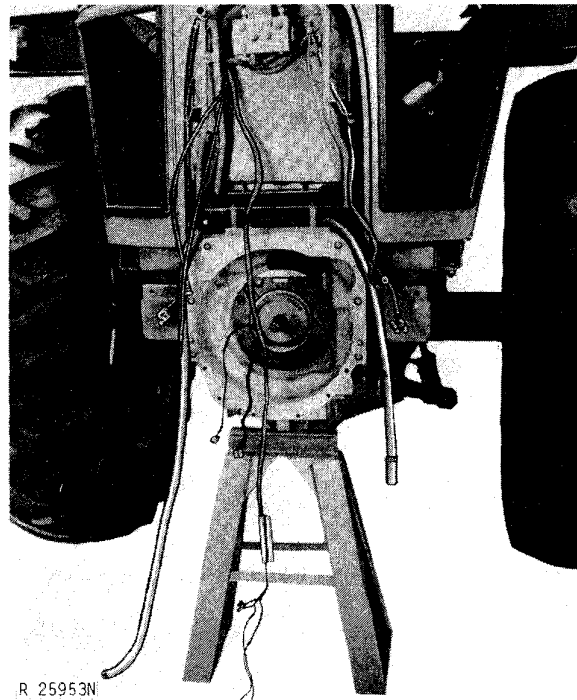

Fig. 37-Engine Separated from Clutch Housing

## Installation

Reverse the removal steps on the preceding pages and note the special installation instructions which follow.

1. (Not Illustrated) Apply a light coat of Permatex No. 3 to the block bolting flange where block and oil pan make contact.

2. (Not Illustrated) On tractors with a Quad-Range or Syncro-Range transmission, be sure that the transmission oil pump drive shaft bushing is in position before reassembling tractor.

**NOTE:** In some cases during separation, the clutch drive shaft may move toward the engine. When this happens, the drive shaft bushing may move with the clutch drive shaft out of the transmission drive shaft and fall into the drive shaft spline area.

3. (Not Illustrated) Tighten engine-to-clutch housing cap screws

- 3/4 inch . . . . . 300 ft-lbs (406 Nm) (40.6 kgm)
- 1/2 inch . . . . . 85 ft-lbs (115 Nm) (11.5 kgm)

4. (Not Illustrated) After installation is complete, perform the following steps in bleeding the brakes.

**Bleeding The Brakes**

- (a) Start the engine.
- (b) Loosen brake bleed screw lock nuts on both sides of transmission case.
- (c) Turn bleed screws out two turns.
- (d) Tighten lock nuts.
- (e) Depress brake pedals for two minutes.
- (f) While pedals are being held down, tighten the bleed screws.
- (g) Tighten the lock nuts.

**REMOVING ENGINE FROM FRONT END**

**Special Tools**

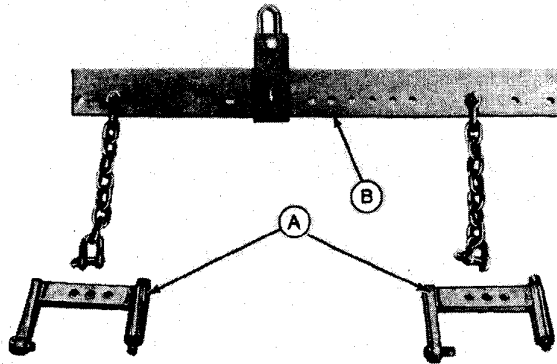

R 26426N

A—JDE-63 Engine Lift Brackets\* B—JDG-1 Engine Lift Sling\*

Fig. 38-Engine Lift Tools

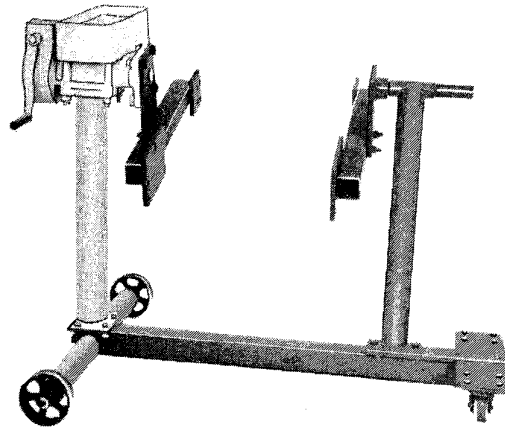

R 26420N

Fig. 39-D-05001ST Repair Stand\*

\*Service Tools  
Box 314, Owatonna MN 55060

**Removal**

- 1. (Not Illustrated) Separate the tractor between the engine and clutch housing as previously described.
- 2. (Not Illustrated) Drain the cooling system.

## Removal—Continued

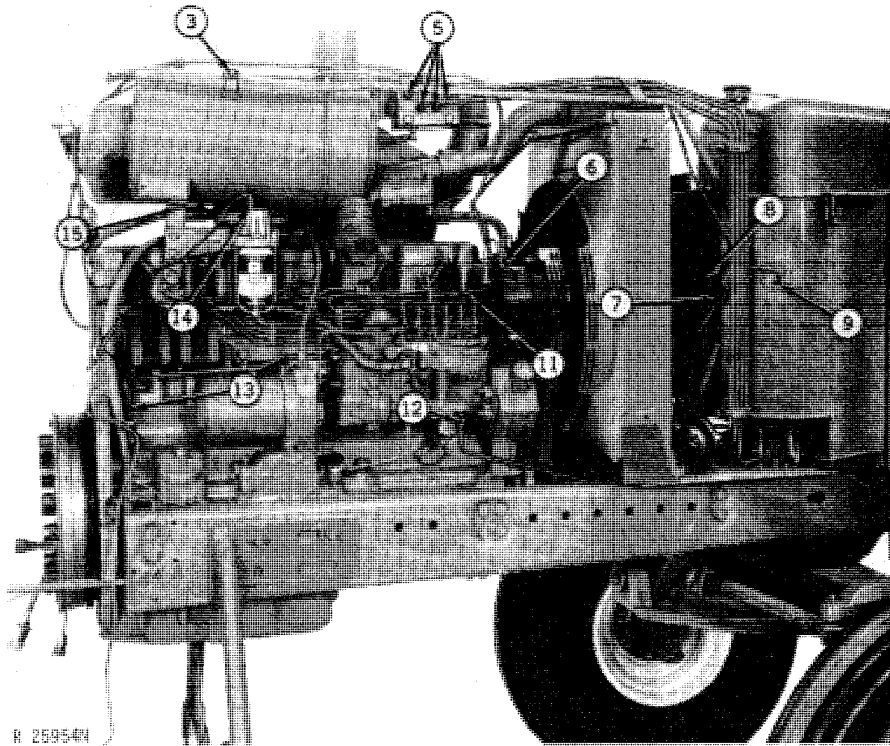

Fig. 40-Right Side Removal Steps

3. Remove oil cooler return pipe clamp from air cleaner. (4630)
4. (Not Illustrated) Clean area around steering valve.
5. Remove steering valve-to-steering meter pipes from steering valve.
6. Remove alternator wiring from alternator.
7. Disconnect horn wiring (if equipped).
8. Disconnect air conditioning wire (if equipped).
9. Disconnect wiring at fuel sender.
10. (Not Illustrated) Close fuel shut-off valve (located under fuel tank).
11. Disconnect fuel leak-off line at injection nozzle.
12. Disconnect fuel tank-to-injection pump pipe at injection pump.
13. Remove engine oil pressure sending unit wiring from sending unit.
14. Remove starting aid wiring from starting aid solenoid.
15. Remove air cleaner support-to-air cleaner cap screw.
16. (Not Illustrated) Remove starting aid support with starting aid from engine.

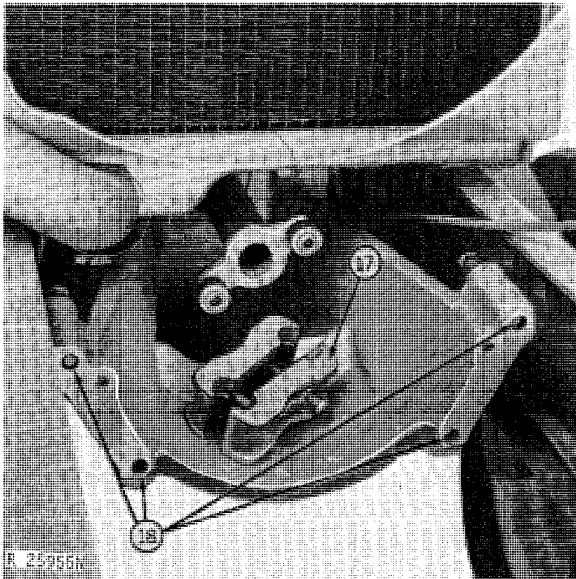

Fig. 41-Hydraulic Pump Drive Coupling  
(Engine removed for illustration purposes)

17. Remove hydraulic pump drive coupling.
18. Remove hydraulic pump support-to-engine cap screws.

19. Remove upper radiator hose from radiator.
20. Remove air cleaner intake pipe-to-exhaust elbow cap screws (4630).
21. Loosen turbocharger intake pipe-to-air cleaner hose clamp.
22. (Not Illustrated) Remove air cleaner and steering valve as a unit from engine (4630).
23. Remove air restriction indicator wiring from indicator.
24. Loosen turbocharger intake pipe-to-turbocharger hose clamp.
25. Remove intake pipe.
26. Remove water manifold-to-intercooler hose (4630).
27. Remove wiring from starter solenoid.
28. (Not Illustrated) Remove complete wiring harness from engine.

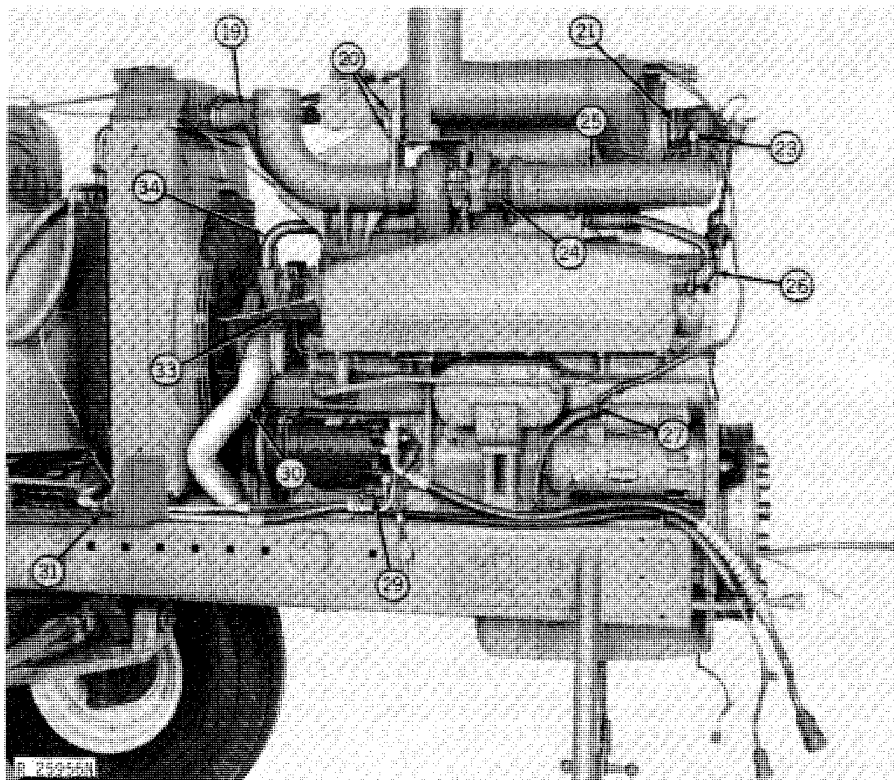
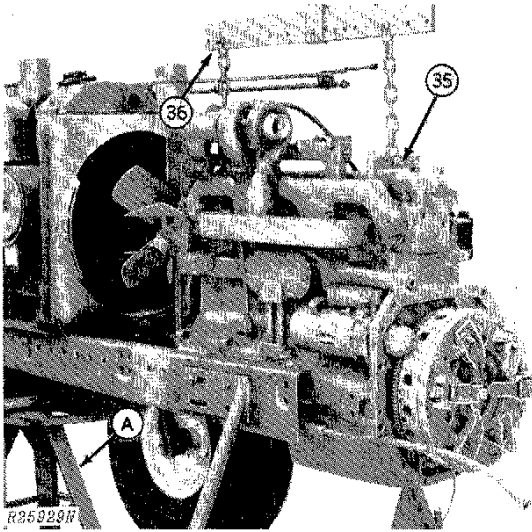

Fig. 42-Left Side Removal Steps

### Removal—Continued

29. Remove air conditioning compressor wiring lead from compressor (if equipped).
30. Remove lower radiator hose from water pump.
31. Remove refrigerant line clamp at radiator base.
32. (Not Illustrated) Remove air conditioning compressor with refrigerant lines attached and secure to front axle.
33. Remove fan blast deflector.
34. Remove water pump bypass pipe.



A—Metal Stand

Fig. 43-Removing Engine

35. Install JDE-63 engine lift brackets.
  36. Connect JDG-1 engine lift sling to lift brackets.
- CAUTION:** Position a metal stand (A) under tractor front end to prevent tipping.
37. Connect lift assembly to a hoist with a one ton (907 kg) load capacity or greater.
  38. Remove side frame-to-engine cap screws.

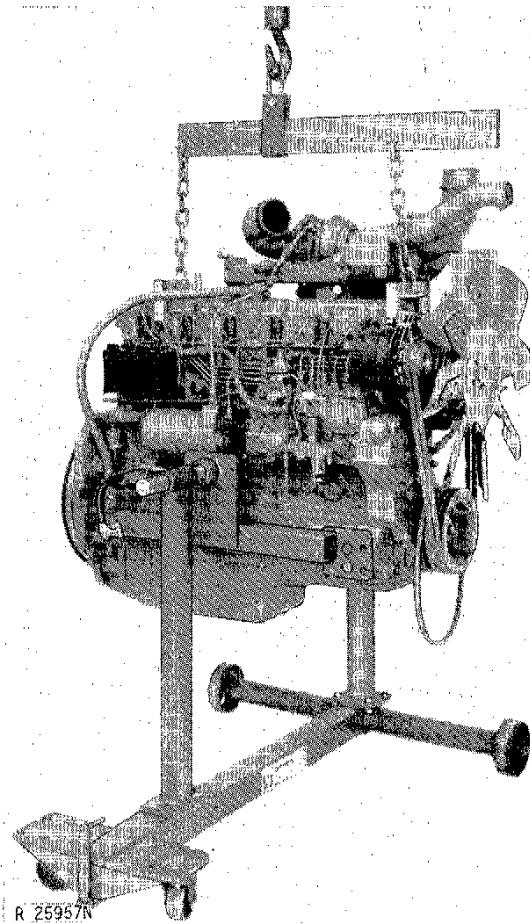
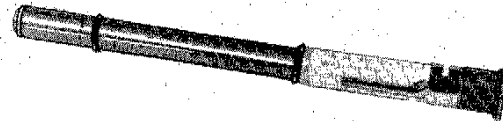

Fig. 44-Placing Engine in Repair Stand.

39. Remove engine and place in D-05001ST repair stand (Fig. 44).

### INSTALLING ENGINE IN FRONT END

#### Special Tools



R 26415N

Fig. 45-JDST-28 Belt Tensioning Tool\*

\*Service Tools  
Box 314, Owatonna, MN 55060

## Assembly

Reverse the removal steps given on the preceding pages and follow the special installation instructions which follow.

1. (Not Illustrated) Tighten hydraulic pump support-to-engine cap screws to 85 ft-lbs (115 Nm) (11.5 kgm).
2. (Not Illustrated) Tighten pump drive coupling to 30 ft-lbs (41 Nm) (4.1 kgm).
3. (Not Illustrated) Tighten side frame-to-engine cap screws to 275 ft-lbs (373 Nm) (37.3 kgm).

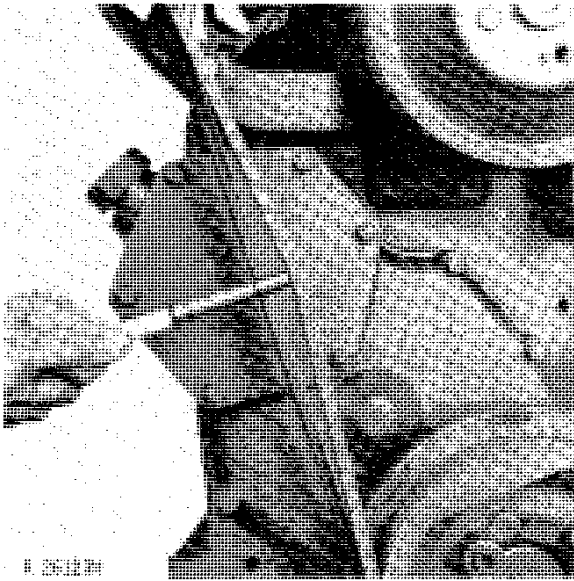
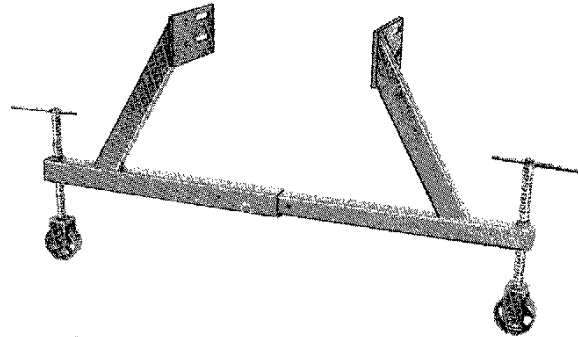

Fig. 46-Using Belt Tensioning Tool

4. Tighten air conditioning compressor drive belt to deflect 1/4 inch (6.35 mm) with a 15 lb. (67 N) force (Fig. 46).
5. Tighten fan belts to deflect 1 inch (25.40 mm) with a 25 lb. (111 N) force (Fig. 46).

## REMOVING FRONT END 4430

### Special Tools



R 26619N

Fig. 47-JDG-12-1 Splitting Stand\*

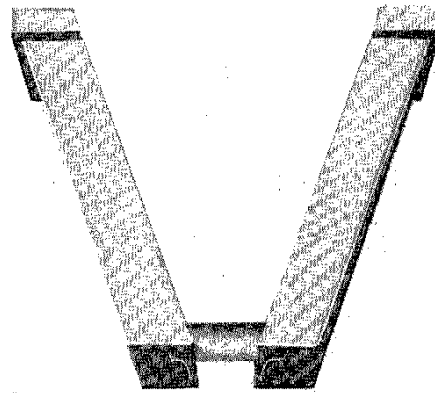

R 26427N

Fig. 48-JDG-7 Lift Bracket\*

\*Service Tools  
Box 314, Owatonna MN 55060

### Removal

1. (Not Illustrated) Disconnect battery ground cable.
2. (Not Illustrated) Drain cooling system.

### Removal—Continued

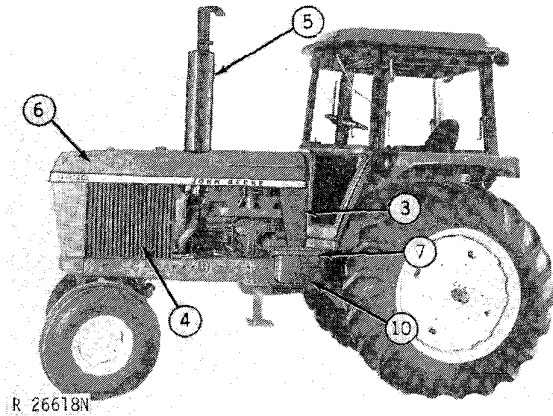

Fig. 49-Removing Muffler, Screens and Shields

3. Remove left and right-hand side shields.
4. Remove left and right-hand grill screens.

5. Remove muffler.
6. Remove hood.
7. Remove left and right-hand battery box covers.
8. (Not Illustrated) Disconnect battery cables.
9. (Not Illustrated) Remove batteries.
10. Remove battery boxes.
11. (Not Illustrated) Remove tool box and bracket.
12. Disconnect hydraulic cooler return pipe.
13. Remove air intake pipe.
14. Remove steering pipe support bracket.
15. (Not Illustrated) Disconnect horn wiring (if equipped).
16. (Not Illustrated) Disconnect air conditioning wire (if equipped).

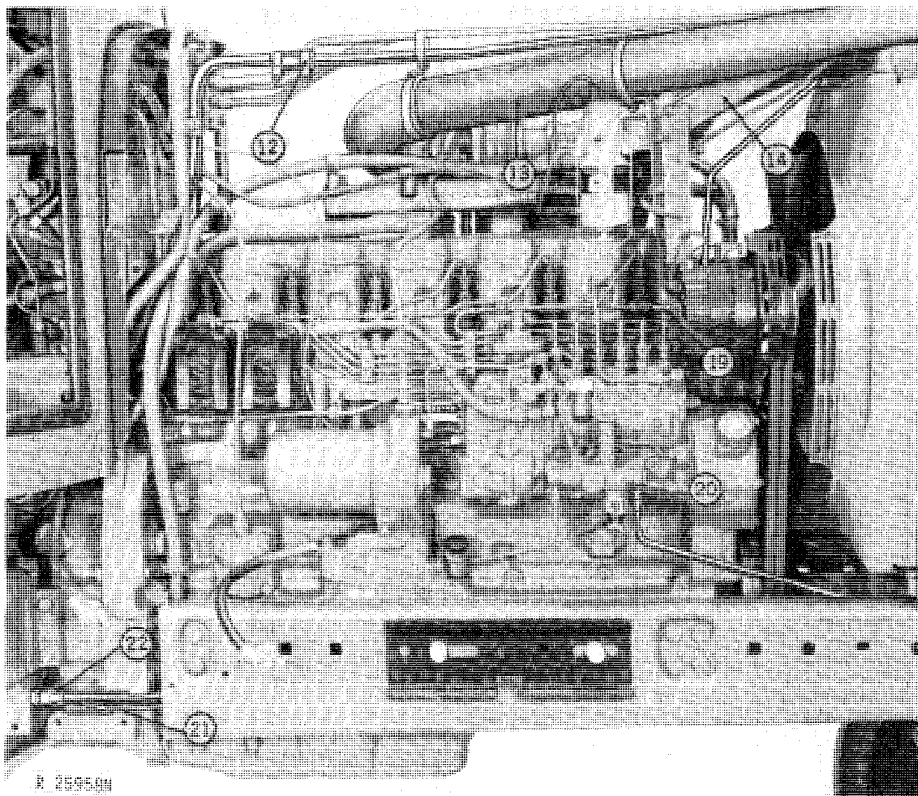
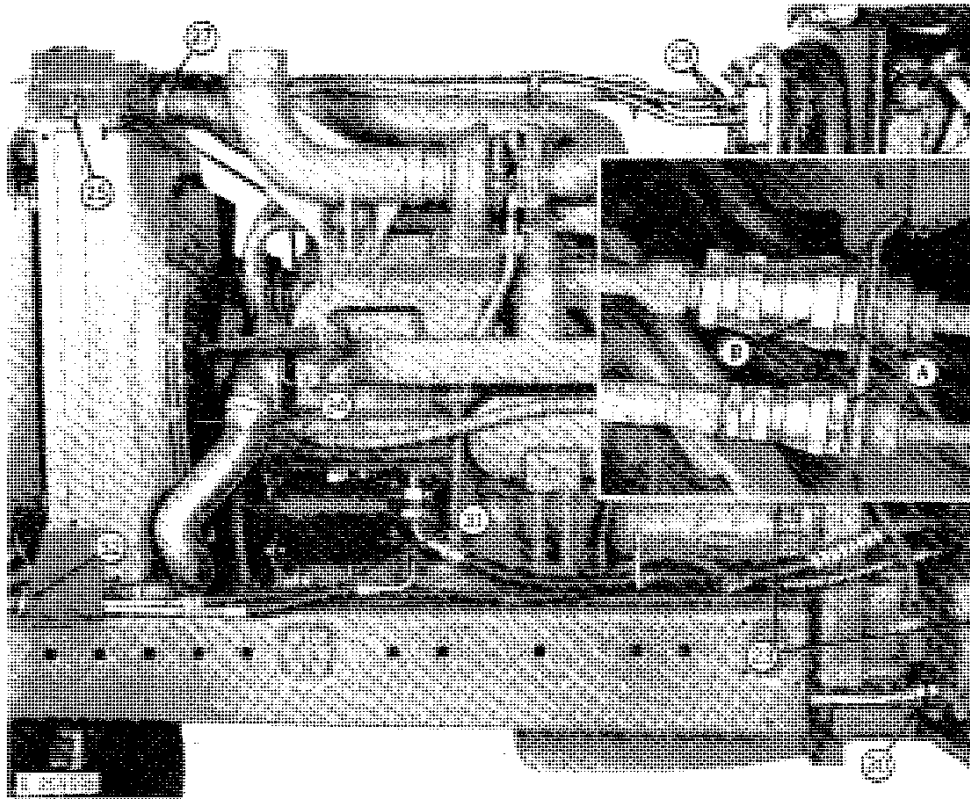

Fig. 50-Right Side Removal Steps



A—Coupler Body

B—Coupler

Fig. 51-Left Side Removal Steps

17. (Not Illustrated) Disconnect wiring at fuel sender.
18. (Not Illustrated) Close fuel shut-off valve.
19. Disconnect fuel leak-off line at injection nozzle.
20. Disconnect fuel tank-to-injection pump pipe at injection pump.
21. Disconnect hydraulic pump seal drain line at transmission.
22. Disconnect hydraulic pump pressure pipe.

**⚠ CAUTION:** Follow all safety precautions found on page 10-25-2 when working with the air conditioning system.

**IMPORTANT:** Keep ends of couplers clean to prevent possible contamination of system.

23. Disconnect refrigerant couplers on tractors with air conditioning.

*NOTE: Disconnect couplers by holding the coupler body (A, Fig. 51) stationary with a wrench and unscrewing coupler (B) with another wrench. If refrigerant can be heard escaping as coupler is loosened, re-tighten coupler and loosen again.*

24. (Not Illustrated) Remove radiator tie rod support.
25. Remove fuel leak-off line clamp at radiator.
26. (Not Illustrated) Remove fuel leak-off line from fuel tank.
27. Remove upper radiator hose from radiator.
28. (Not Illustrated) Thoroughly clean area around steering valve.
29. Disconnect steering lines from steering valve.
30. Disconnect hydraulic pump return line.
31. Remove air conditioning compressor wiring lead from compressor.

## Removal—Continued

32. Remove refrigerant line clamp at radiator base.
33. (Not Illustrated) Remove air conditioning compressor with refrigerant lines attached and secure to front axle.
34. Disconnect lower radiator hose from water pump.

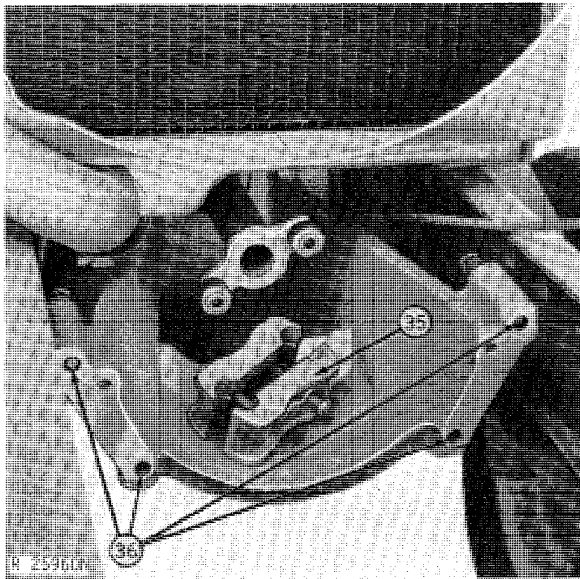

Fig. 52-Hydraulic Pump Drive Coupling (Engine removed for illustration purposes)

35. Remove hydraulic pump drive coupling.
36. Remove hydraulic pump support bracket-to-engine cap screws.

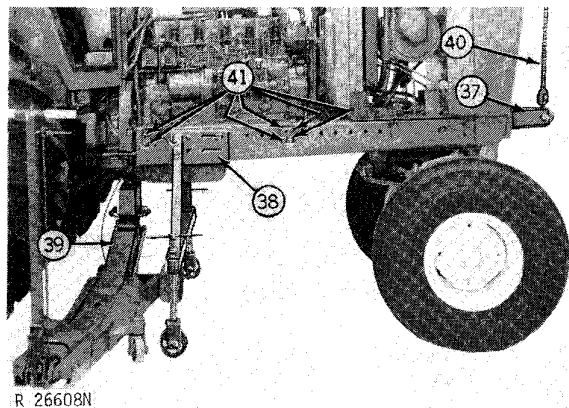

Fig. 53-Attaching Lift Bracket and Splitting Stand

37. Install JDE-7 Lift Bracket to front end.
38. Attach JDG-12-1 Splitting Stand to side frames.
39. Position a floor jack under clutch housing-to-engine parting surface.
40. Attach a chain hoist to JDE-7 Lift Bracket.
41. Remove side frame-to-engine cap screws, then roll front end away from engine.

## INSTALLING FRONT END 4430

### Special Tools

JDST-28 Belt Tensioning Tool (Fig. 45, p. 10-25-18).

### Assembly

Reverse the removal steps given on the preceding pages and note the special installation instructions which follow.

1. (Not Illustrated) Tighten hydraulic pump support-to-engine cap screws to 85 ft-lbs (115 Nm) (11.5 kgm).
2. (Not Illustrated) Tighten pump drive coupling to 30 ft-lbs (41 Nm) (4.1 kgm).
3. (Not Illustrated) Tighten side frame-to-engine cap screws to 275 ft-lbs (373 Nm) (37.3 kgm).
4. (Not Illustrated) Tighten air conditioning compressor drive belt to deflect 1/4 inch (6.35 mm) with a 15-lb. (67 N) force. (Fig. 46, p. 10-25-19).
5. (Not Illustrated) Tighten fan belts to deflect 1 inch (25.40 mm) with a 25-lb. (111 N) force. (Fig. 46, p. 10-25-19).

## REMOVING FRONT END 4630

### Special Tools

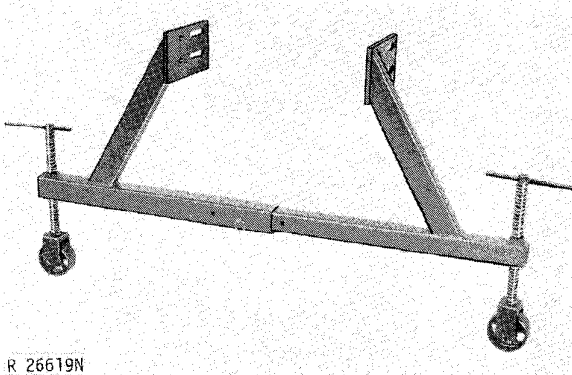

R 26619N

Fig. 54-JDG-12-1 Splitting Stand\*

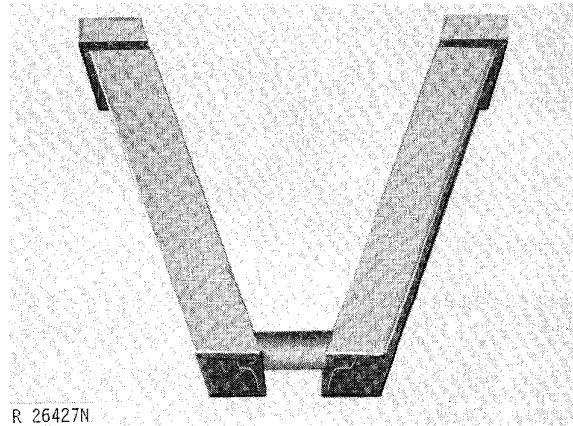

R 26427N

Fig. 55-JDE-7 Lift Bracket\*

\*Service Tools  
Box 314, Owatonna MN 55060

### Removal

1. (Not Illustrated) Disconnect battery ground cable.

2. (Not Illustrated) Drain cooling system.

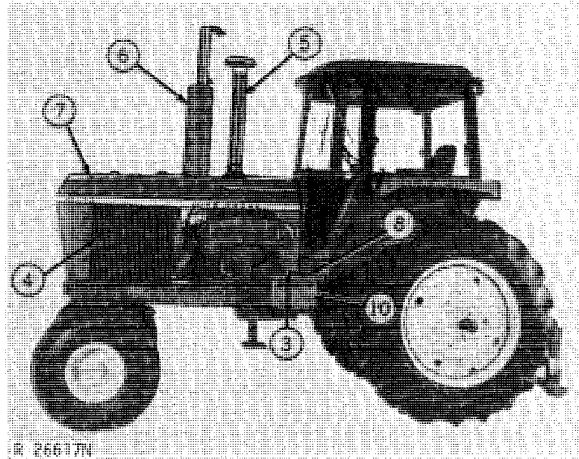

R 26617N

Fig. 56-Removing Muffler, Screens and Shields

3. Remove left and right-hand side shields.
4. Remove left and right-hand grill screens.
5. Remove air stack.
6. Remove muffler.
7. Remove hood.
8. Remove left and right-hand battery box covers.
- 9 (Not Illustrated) Disconnect battery cables.
10. Remove batteries and battery boxes.
11. (Not Illustrated) Remove tool box and bracket.

## Removal—Continued

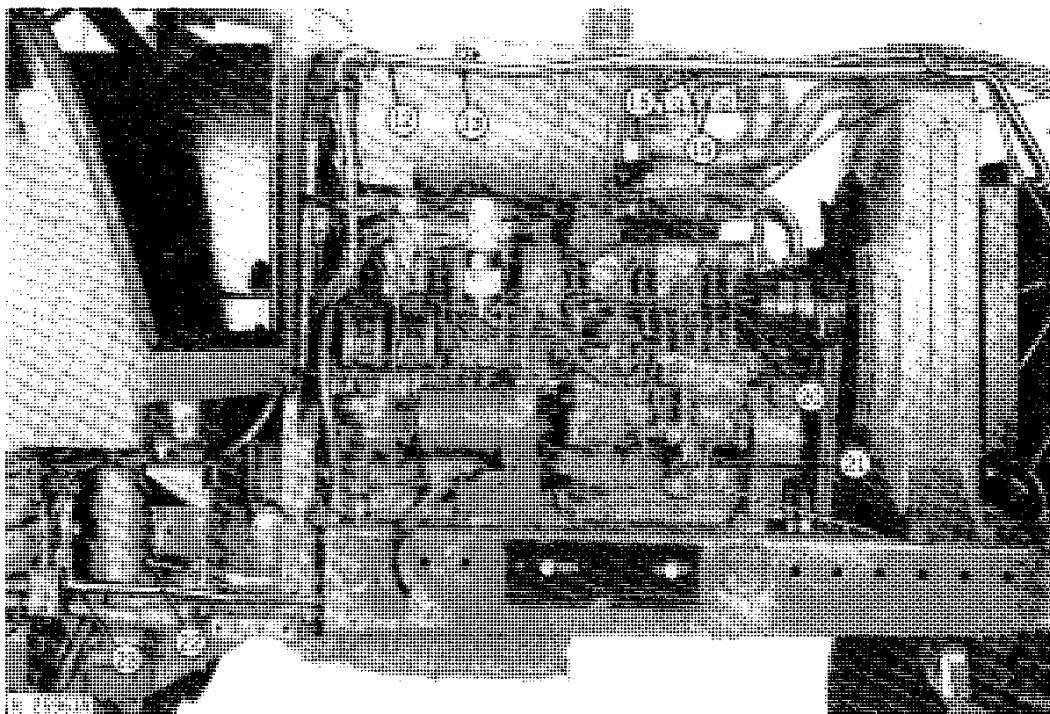

Fig. 57-Right Side Removal Steps

12. Disconnect hydraulic cooler return pipe.
13. Disconnect hydraulic cooler return pipe clamp.
14. (Not Illustrated) Thoroughly clean area around steering valve.
15. Remove steering valve-to-steering motor pipes from steering valve.
16. (Not Illustrated) Disconnect horn wiring (if equipped).
17. (Not Illustrated) Disconnect wiring at fuel sender.
18. (Not Illustrated) Disconnect air conditioning wire (if equipped).
19. (Not Illustrated) Close fuel shut-off valve.
20. Disconnect fuel leak-off line at injection nozzle.

21. Disconnect fuel tank-to-injection pump line at injection pump.

22. Disconnect hydraulic pump seal drain line at transmission.

23. Disconnect hydraulic pump pressure pipe.

**⚠ CAUTION:** Follow all safety precautions found on page 10-25-2 when working with the air conditioning system.

**IMPORTANT:** Keep ends of couplers clean to prevent possible contamination of system.

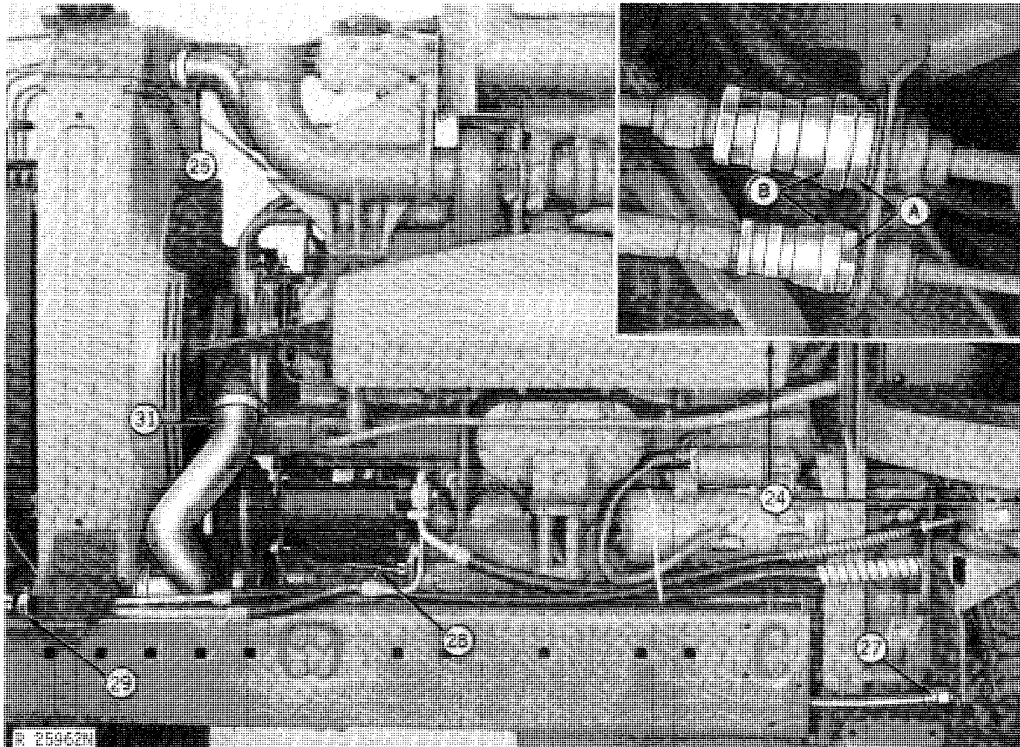

A—Coupler Body

B—Coupler

Fig. 58-Left Side Removal Steps

24. Disconnect refrigerant couplers on tractors with air conditioning.

*NOTE: Disconnect couplers by holding the coupler body (A, Fig. 58) stationary with a wrench and unscrewing coupler (B) with another wrench. If refrigerant can be heard escaping as coupler is loosened, re-tighten coupler and loosen again.*

25. Remove upper radiator hose from radiator.

26. (Not Illustrated) Remove radiator tie rod support.

27. Disconnect hydraulic pump return line.

28. Remove air conditioning compressor wiring lead from compressor.

29. Remove refrigerant line clamp at radiator base.

30. (Not Illustrated) Remove air conditioning compressor with refrigerant lines attached and secure to front axle.

31. Disconnect lower radiator hose from water pump.

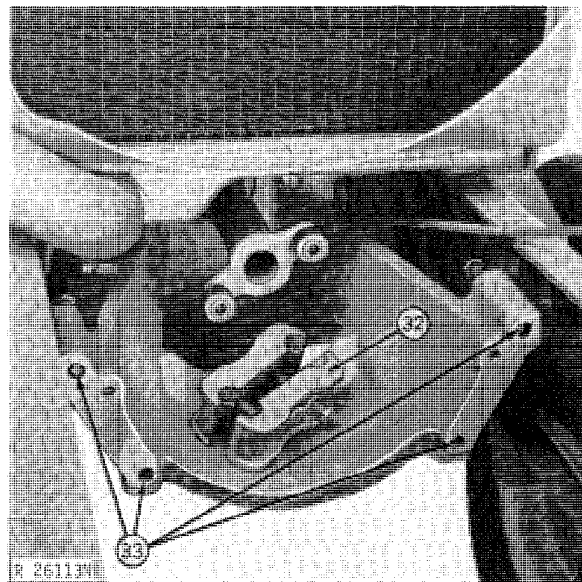

Fig. 59-Hydraulic Pump Drive Coupling (Engine removed for illustration purposes)

32. Remove hydraulic pump drive coupling.

33. Remove hydraulic pump support bracket-to-engine cap screws.

## Removal—Continued

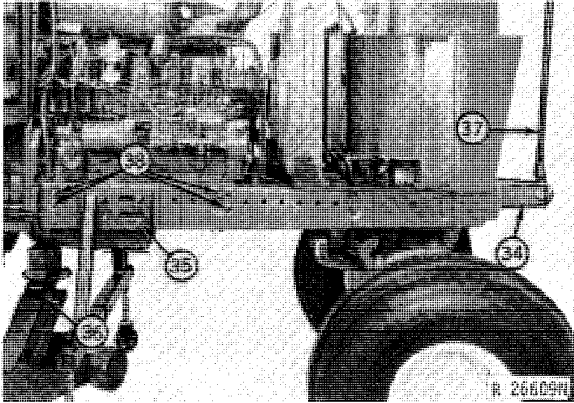

Fig. 60-Attaching Lift Bracket and Splitting Stand

34. Install JDE-7 Lift Bracket on front end.
35. Attach JDG-12-1 Splitting Stand to side frames.
36. Position a floor jack under clutch housing-to-engine parting surface.
37. Attach a chain hoist to JDE-7 Lift Bracket.
38. Remove side frame-to-engine cap screws.
39. Roll front end away from engine.

## INSTALLING FRONT END 4630

### Special Tools

JDST-28 Belt Tensioning Tool (Fig. 45, p. 10-25-18).

### Assembly

Reverse the removal steps given on the preceding pages and note the special installation instructions which follow.

1. Tighten hydraulic pump support-to-engine cap screws to 85 ft-lbs (115 Nm) (11.5 kgm).

2. Tighten pump drive coupling to 30 ft-lbs (41 Nm) (4.1 kgm).
3. Tighten side frame-to-engine cap screws to 275 ft-lbs (373 Nm) (37.3 kgm).
4. Tighten air conditioning compressor drive belt to deflect 1/4 inch (6.35 mm) with a 15-lb. (67 N) force (Fig. 4, p. 10-25-19).
5. Tighten fan belts to deflect 1 inch (25.40 mm) with a 25-lb. (111 N) force (Fig. 46, p. 10-25-19).

## SEPARATING CLUTCH HOUSING FROM POWER SHIFT TRANSMISSION CASE

### Removal

*NOTE: If access to the rear clutch pack, planetary pack, or PTO gear train is desired, remove the Sound-Gard Body with control support, and separate the engine from the clutch housing as previously instructed. If access to only the front clutch pack is desired, only separate the engine from the clutch housing.*

1. (Not Illustrated) Separate the engine from the clutch housing as previously instructed.
2. (Not Illustrated) Drain the transmission.

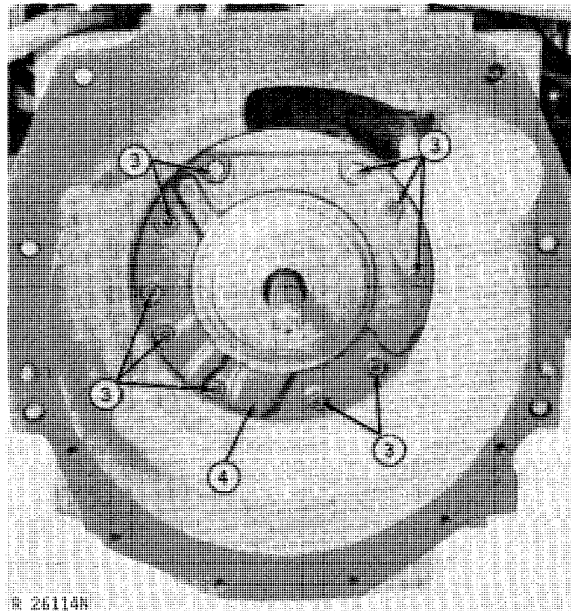

Fig. 61-Clutch Pack and Transmission Pump

3. Remove clutch pack-to-housing cap screws.
4. Remove clutch pack and transmission pump assembly.

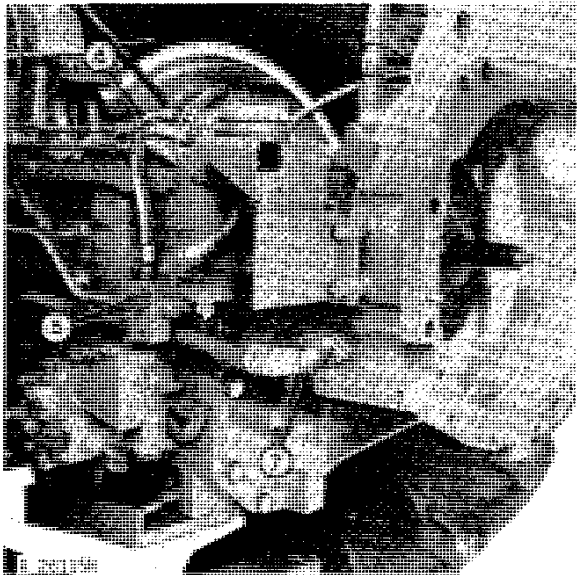

Fig. 62-Right Side Removal Steps

5. Remove pressure oil manifold-to-clutch housing cap screws.
6. Remove pressure oil manifold-to-attenuator hose from attenuator.
7. Remove transmission oil pump intake elbow.

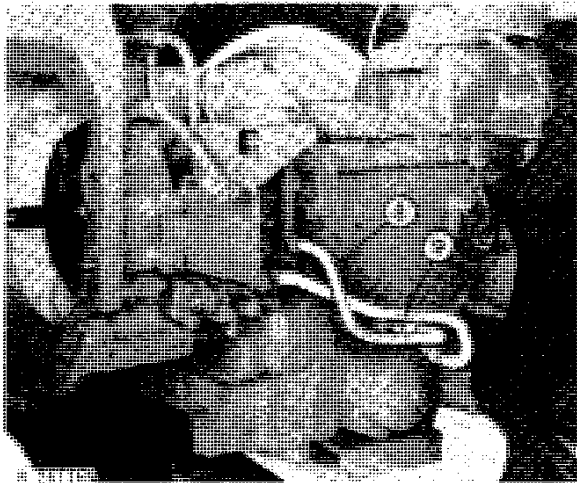

Fig. 63-Left Side Removal Steps

8. Remove oil filter inlet pipe.
9. Remove oil filter-to-regulator housing pipe.

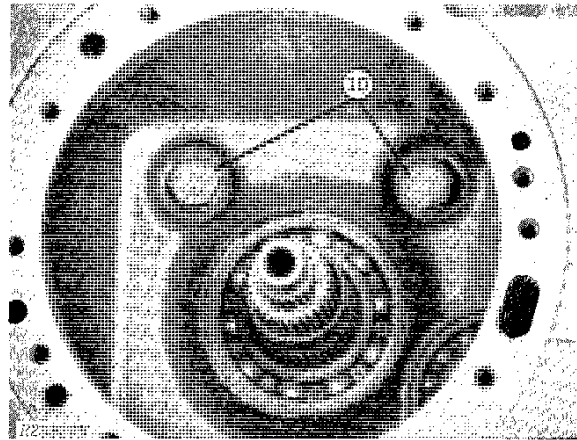

Fig. 64-Cap Screws

10. Remove two hidden clutch housing-to-transmission cap screws.

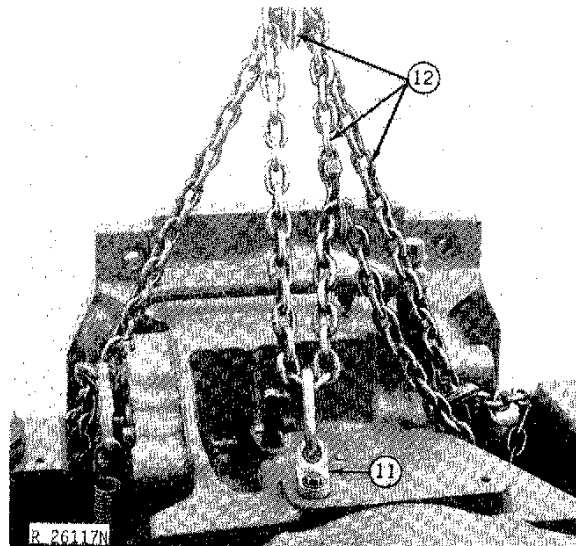

Fig. 65-Attaching Chain Hoist

11. Attach JDG-19 Lift Eye to clutch housing.
12. Attach a chain hoist and chain with a 400-lb. (181.4 Kg.) capacity or greater to clutch housing.
13. (Not Illustrated) Remove clutch housing-to-transmission case cap screws.

## Removal—Continued

**IMPORTANT:** When separating clutch housing from transmission case, do not lose small rubber "O" rings.

14. (Not Illustrated) Separate clutch housing from transmission case.

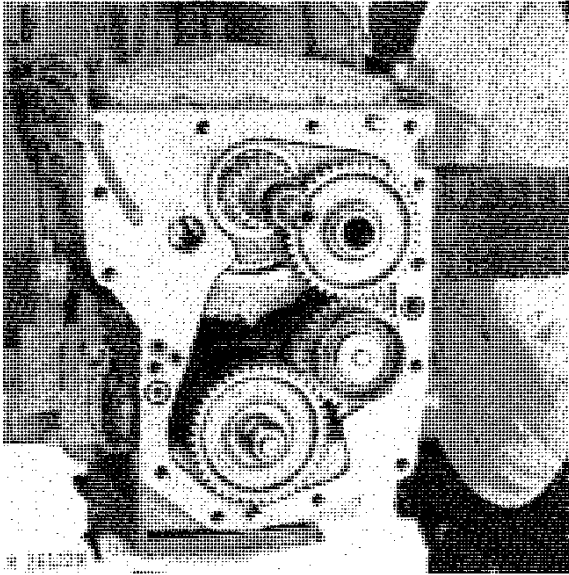

Fig. 66-Clutch Housing Removed

## Installation

Reverse the removal steps on the preceding pages and note the special installation instructions which follow.

1. (Not Illustrated) Insure that O-rings between clutch housing and transmission are in position before assembly.

2. (Not Illustrated) Tighten the clutch housing-to-transmission cap screws.

5/8 inch . . . . . 170 ft-lbs (230 Nm) (23 kgm)  
3/4 inch . . . . . 300 ft-lbs (406 Nm) (40.6 kgm)

3. (Not Illustrated) Tighten oil filter inlet pipe elbow cap screws to 45 ft-lbs (61 Nm) (6.1 kgm).

## SEPARATING THE CLUTCH HOUSING FROM QUAD-RANGE TRANSMISSION CASE

### Special Tools

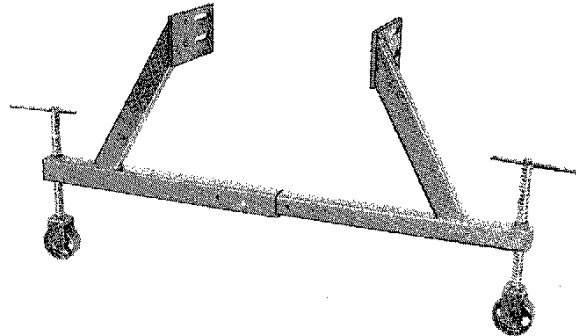

R 26619N

Fig. 67-JDG-12-1 Splitting Stand\*

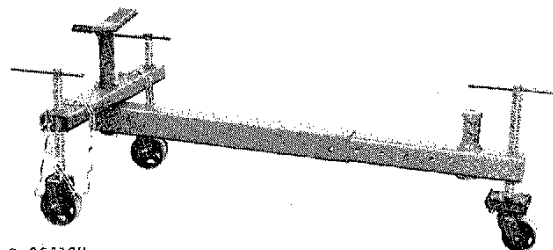

R 26419N

Fig. 68-JDG-2M Rear Splitting Stand\*

\*Service Tools Inc.,  
Box 314, Owatonna MN 55060

## Removal

1. Remove Sound-Gard Body without control support.

2. Drain the transmission.

**IMPORTANT:** Remove hexagonal transmission pump drive shaft before beginning separation. Install drive shaft last.



**Suggest:**

**If the above button click is invalid.**

**Please download this document**

**first, and then click the above link**

**to download the complete manual.**

**Thank you so much for reading**

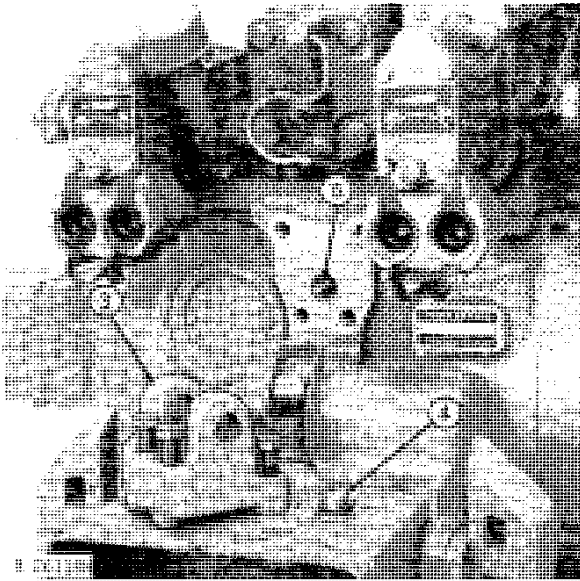

Fig. 69-Removing Transmission Pump Drive Shaft

3. Remove center link attaching bracket.
4. Remove plug.
5. Carefully withdraw transmission pump drive shaft.

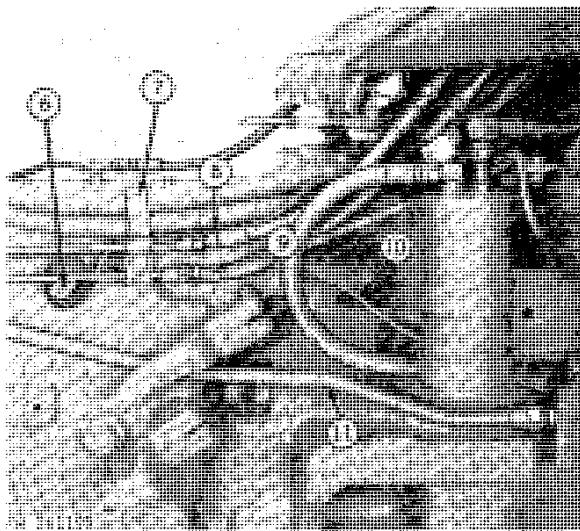

Fig. 70-Right Side Removal Steps

6. Remove start safety switch wiring.
7. Bend open heater hose clamp, and remove heater hoses.

**⚠ CAUTION:** Before disconnecting brake pressure lines, be sure that the brake accumulator is discharged. The accumulator can be discharged by opening the right-hand brake bleed screw, and holding the pedal down for a few minutes.

8. Disconnect right-hand brake line.
9. Disconnect differential lock pressure line.
10. Disconnect transmission pump seal drain line from transmission.
11. Remove rockshaft pressure pipe.

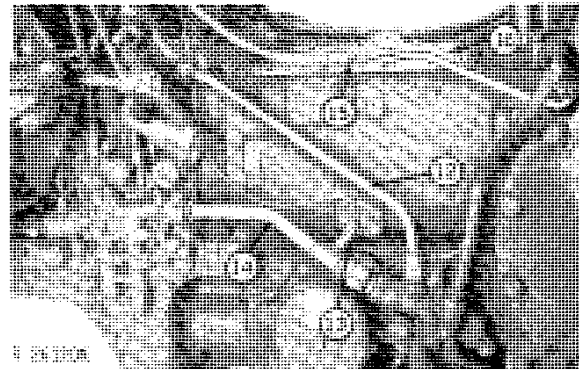

Fig. 71-Left Side Removal Steps

12. Remove clutch valve pressure oil pipe.
13. Disconnect pressure switch wiring.
14. Remove oil filter relief bypass pipe.
15. Disconnect left-hand brake line.
16. Remove transmission case cover.

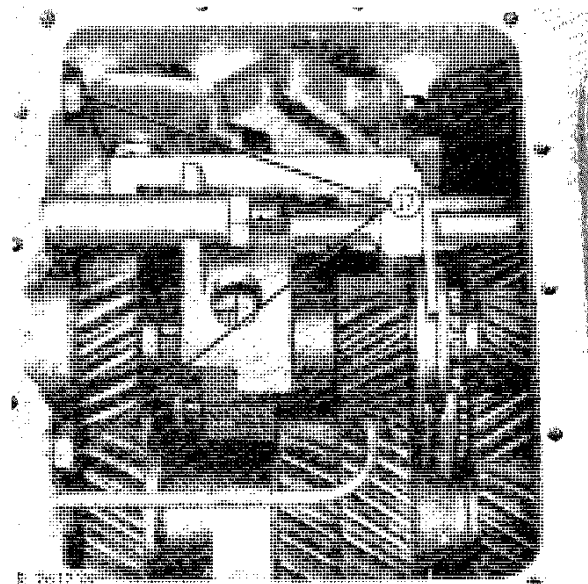

Fig. 72-Cap Screws

**<https://www.ebooklibonline.com>**

Hello dear friend!

Thank you very much for reading.

Enter the link into your browser.

The full manual is available for immediate download.

**<https://www.ebooklibonline.com>**