

4400 and 4420 Combines



JOHN DEERE

TECHNICAL MANUAL 4400 and 4420 Combines

TM1237 (01Jun84) English

John Deere Harvester Works
TM1237 (01Jun84)

LITHO IN U.S.A.
ENGLISH



4400 AND 4420 COMBINES

TECHNICAL MANUAL
TM-1237 (Jun-84)

CONTENTS

SECTION 10 - GENERAL

SECTION 20 - 219 AND 329 DIESEL ENGINE REPAIR

- Group 00 - Specifications and Special Tools
- Group 05 - Cylinder Head, Valves and Camshaft
- Group 10 - Block Liners, Pistons, and Rods
- Group 15 - Crankshaft, Main Bearings, and Flywheel
- Group 20 - Lubrication System
- Group 25 - Cooling System

SECTION 22 - 359 DIESEL ENGINE REPAIR

- Group 00 - Contents
- Group 05 - Cylinder Head, Valve, Timing Gear Train and Camshaft
- Group 10 - Cylinder Block, Liners, Pistons and Rods
- Group 15 - Crankshaft, Main Bearing and Flywheel
- Group 20 - Lubrication System
- Group 25 - Cooling System

SECTION 25 - GASOLINE ENGINE REPAIR

- Group 00 - Specifications and Special Tools
- Group 05 - Cylinder Head, Valves and Camshaft
- Group 10 - Block Liners, Pistons, and Rods
- Group 15 - Crankshaft, Main Bearings, and Flywheel
- Group 20 - Lubrication System
- Group 25 - Cooling System
- Group 30 - Governor and Speed Control Linkage

SECTION 30 - FUEL AND AIR REPAIR

- Group 00 - Specifications and Special Tools
- Group 05 - Air Intake System
- Group 10 - 219 and 329 Diesel Fuel System
- Group 12 - 359 Diesel Fuel System
- Group 15 - Control Linkage

SECTION 40 - ELECTRICAL REPAIR

- Group 00 - Specifications and Special Tools
- Group 05 - Harness Replacement
- Group 10 - Charging Circuit Repair
- Group 15 - Starting Circuit Repair
- Group 20 - Ignition System Repair
- Group 25 - Lights and Accessory Circuits

SECTION 50 - POWER TRAIN REPAIR

- Group 00 - Specifications and Special Tools
- Group 05 - Clutch
- Group 10 - Transmission
- Group 15 - Differential
- Group 20 - Final Drive
- Group 25 - Final Drive

SECTION 60 - STEERING/BRAKES REPAIR

- Group 00 - Specifications
- Group 05 - Power Steering
- Group 10 - Brakes

SECTION 70 - HYDRAULIC REPAIR

- Group 00 - Specifications and Special Tools
- Group 05 - Reservoir
- Group 10 - Hydraulic Pumps
- Group 15 - Hydraulic Valves
- Group 20 - Hydraulic Cylinders
- Group 25 - Hydraulic Motors
- Group 30 - Accumulator

SECTION 80 - SEPARATOR SHELL REPAIR

- Group 00 - Specifications
- Group 05 - Rear Hood
- Group 10 - Cylinder Rear Cover
- Group 15 - Separator Uprights

SECTION 90 - OPERATOR STATION REPAIR

- Group 00 - Specifications and Special Tools
- Group 05 - Air Conditioning System
- Group 10 - Pressurizer System
- Group 15 - Heating System
- Group 20 - Personal Posture Seat
- Group 25 - Cab Roof

SECTION 100 - HEADER REPAIR

- Group 00 - Specifications and Special Tools
- Group 05 - 200 Series Cutting Platforms
- Group 10 - Quik-Tatch Cutting Platforms
- Group 15 - 40 Series Corn Heads
- Group 20 - Row-Crop Heads

Copyright 1984 DEERE AND COMPANY
Moline, Illinois All rights reserved
Previous Editions

Copyright © 1980 Deere and Company
Copyright © 1981 Deere and Company

2 Contents

SECTION 110 - FEEDER HOUSE REPAIR

- Group 00 - Specifications
- Group 05 - Feeder Conveyor Chain
- Group 10 - Feeder Conveyor Drum
- Group 15 - Variable Speed Feeder House Drives
- Group 20 - Feeder House Lower Shaft
- Group 25 - Feeder House Upper Shaft

SECTION 120 - SEPARATOR REPAIR

- Group 00 - Specifications and Special Tools
- Group 05 - Cylinder, Concave, and Beater
- Group 10 - Cylinder Drives
- Group 15 - Straw Walkers and Crankshafts
- Group 20 - Straw Chopper and Straw Spreader
- Group 25 - Shoe Supply Augers, Cleaning Fan, and Shoe Frame
- Group 30 - Tailings Elevator and Augers
- Group 35 - Lower Auger, Clean Grain Elevator, and Grain Tank Loading Auger

SECTION 130 - GRAIN TANK UNLOADING SYSTEM REPAIR

- Group 00 - Specifications
- Group 05 - Grain Tank Auxiliary Unloading Augers and Drive
- Group 10 - Grain Tank Inner and Outer Unloading Augers

SECTION 140 - MAJOR DRIVES REPAIR

- Group 00 - Specifications
- Group 05 - Engine Powershaft
- Group 10 - Primary Countershaft
- Group 15 - Secondary Countershaft

SECTION 160 - AUTOMATIC HEADER HEIGHT CONTROL REPAIR

- Group 00 - Specifications and Special Tools
- Group 05 - Repair of Components

SECTION 220 - ENGINE OPERATION AND TESTS

- Group 00 - Specifications and Special Tools
- Group 05 - System Operation
- Group 10 - System Tests and Diagnosis

SECTION 230 - FUEL/AIR OPERATION AND TESTS

- Group 00 - Specifications and Special Tools
- Group 05 - Air Intake System
- Group 10 - Diesel Fuel System
- Group 15 - Control Linkage

SECTION 240 - ELECTRICAL OPERATION AND TESTS

- Group 00 - Specifications and Special Tools
- Group 05 - General Information and Diagrams
- Group 10 - Charging Circuit Diagnosis
- Group 15 - Starting Circuit Diagnosis
- Group 20 - Lights, Instruments, and Accessory Circuits Diagnosis

SECTION 250 - POWER TRAIN OPERATION AND TESTS

- Group 00 - Specifications and Special Tools
- Group 05 - Clutch Diagnosis
- Group 10 - Transmission Diagnosis
- Group 15 - Final Drive Diagnosis

SECTION 260 - STEERING/BRAKES OPERATION AND TESTS

- Group 00 - Specifications
- Group 05 - Power Steering
- Group 10 - Brakes

SECTION 270 - HYDRAULIC OPERATION AND TESTS

- Group 00 - Specifications and Special Tools
- Group 01 - Hydraulic System Operation
- Group 05 - Hydraulic System Tests
- Group 10 - Reservoir
- Group 15 - Hydraulic Pumps
- Group 20 - Hydraulic Valves
- Group 25 - Hydraulic Cylinders
- Group 30 - Hydraulic Motors
- Group 35 - Accumulator

SECTION 290 - OPERATOR STATION OPERATION AND TESTS

- Group 00 - Specifications and Special Tools
- Group 05 - Air Conditioning Operation and Tests
- Group 10 - Pressurizer System
- Group 15 - Heating System

<https://www.ebooklibonline.com>

Hello dear friend!

Thank you very much for reading.

Enter the link into your browser.

The full manual is available for immediate download.

<https://www.ebooklibonline.com>

SECTION 360 - AUTOMATIC HEADER HEIGHT
CONTROL OPERATION AND
TESTS

- Group 00 - Specifications and Special Tools
- Group 05 - General Information, Diagnosis, and Tests
- Group 10 - Mechanical System
- Group 15 - Electrical System
- Group 20 - Hydraulic System
- Group 25 - General Information, Diagnosis, and Tests - DIAL-A-MATIC™
- Group 30 - Mechanical System - DIAL-A-MATIC
- Group 35 - Electrical System - DIAL-A-MATIC
- Group 40 - Hydraulic System - DIAL-A-MATIC

Throughout this manual dimensions are shown as follows: (1.75 mm) .069". The measurement in parentheses was converted from the design dimension.

All information, illustrations and specifications contained in this technical manual are based on the latest information available at the time of publication. The right is reserved to make changes at any time without notice.

The specifications given in this manual are intended for service only. They do not include normal factory manufacturing tolerances.

TECHNICAL MANUAL TABS

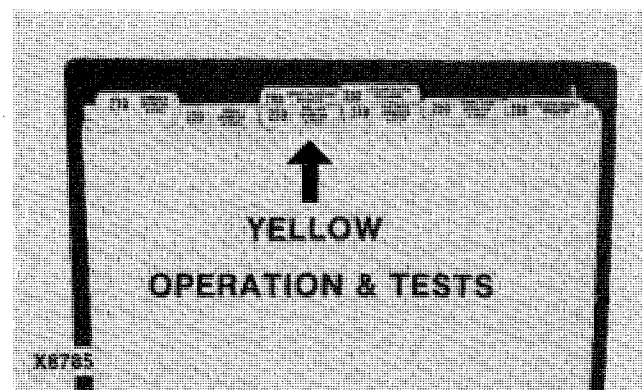
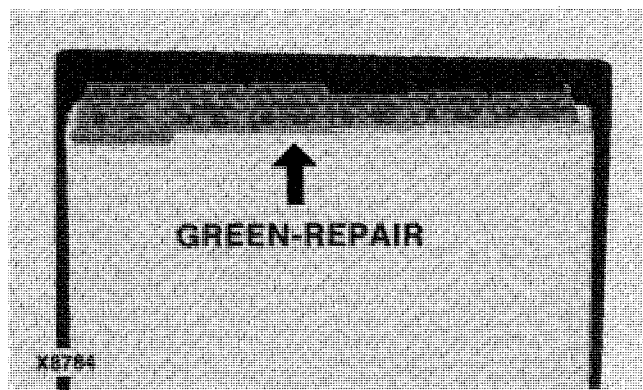
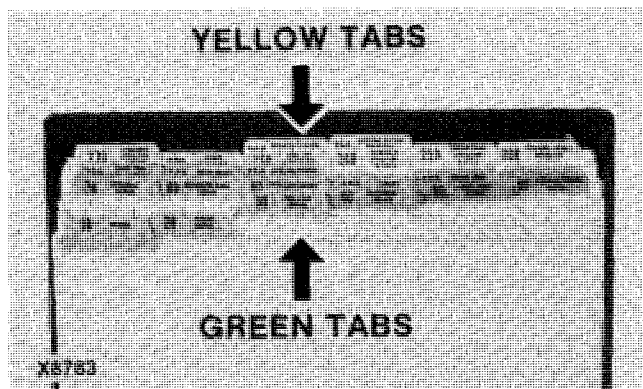

INTRODUCTION

To fully utilize this technical manual, you must understand how it is organized.

Only two tab colors are used—green and yellow. Each color represents a different type of information.

Spend a minute reading this now and save many minutes of searching later.

GREEN TAB SECTIONS

The green tab sections are repair sections that tell how to repair the components of the various systems.

Repair of a component includes:

- Removal from machine (when necessary)
- Disassembly
- Inspection
- Replacement of parts
- Assembly
- Adjustment
- Installation on machine (when necessary)

The numbers used for the repair (green tab) sections are part of an overall service publication numbering system. The numbers identify the same sections in the parts catalog, flat rate manual, service information bulletins, and service training courses.

YELLOW TAB SECTIONS

Each yellow tab section contains information on:

- System Operation
- System Tests

System operation explains how the system and its components work.

System tests tell how to test the system and diagnose the problem.

TAB POSITIONS

Each green tab and its corresponding yellow tab have the same tab position. This is to help you quickly locate the related information.

COLOR	POSITION	SEC. NO.	DESCRIPTION
Green	2nd	20	Engine Repair
Yellow	2nd	220	Engine Operation and Tests

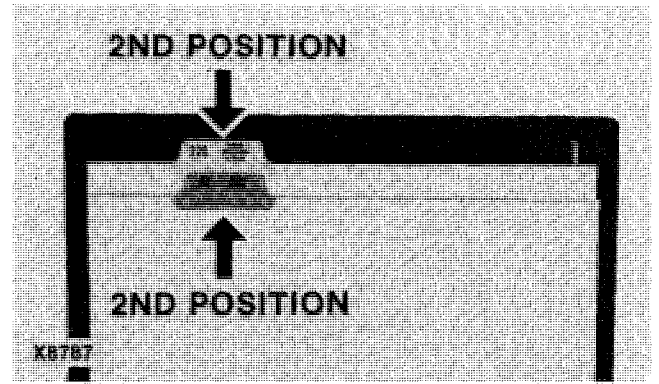

X8787

HOW TO USE

Use the following three-step procedure to locate the desired information.

1. Determine the type of information you need. Is it repair, operation, or tests?
2. Go to the appropriate section tab:
 Green for Repair
 Yellow for Operation or Tests

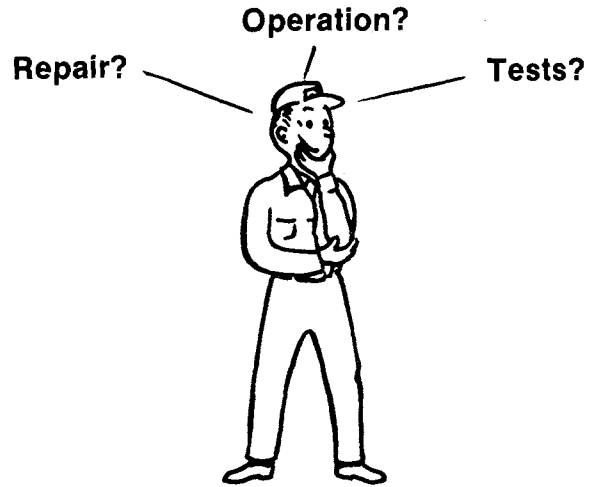

X8788

TYPE OF INFORMATION?

X8786

3. Use the table of contents on the first page of the section to locate the information.

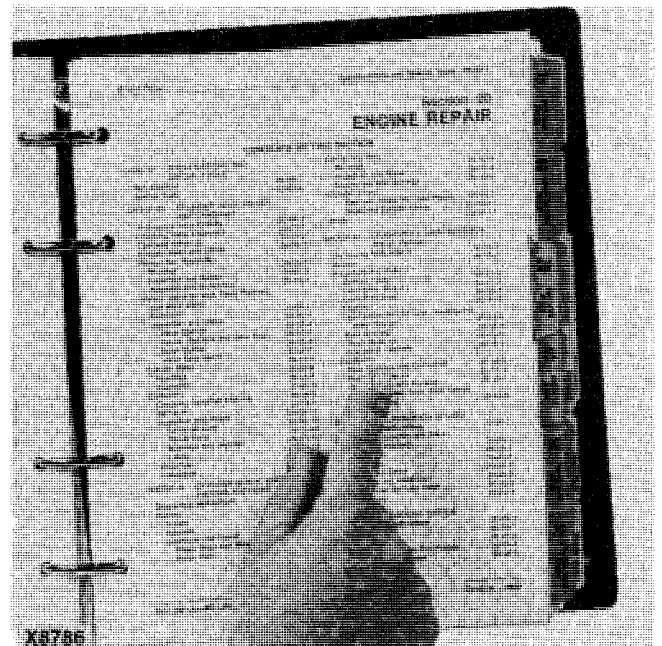

X8786

X8786

Section 10 GENERAL

CONTENTS OF THIS SECTION

	Page
GROUP 00 - GENERAL SPECIFICATIONS	
Serial Numbers	00-1
Specifications	00-2
Ground Speeds	00-3
Dimensions	00-4
GROUP 05 - DIAGNOSING AND TESTING PROCEDURES	
	05-1
GROUP 10 - TUNE-UP AND ADJUSTMENT	
General Information	10-1
Preliminary Engine Testing	10-1
Engine Tune-Up	10-1
Adjustments	10-3
Torque Chart	10-3
Care and Maintenance of Belts and Chains ..	10-4

Group 00 GENERAL SPECIFICATIONS

SERIAL NUMBERS

Serial Number Unit	Location	Serial Number Unit	Location
Separator (-550000)	Rear left hand upright	Cutting Platform and	
(550001-)	Near right hand side of tool box	Pickup Platform	Left-hand side of main frame
Engine	Right-hand side of engine block	Corn Head	Lower right-hand side on bulk-head frame
Feeder House (Early 4400 Combines)	Right-hand side sheet	Row-Crop Head.	Left-hand side end sheet of main frame

SPECIFICATIONS

Engines:

4400	Gasoline	Diesel
(292-9BS)	(-694)	(HC-219-D)
(292-1CL)	(695-3300)	(- 3300)*
(292-1DO)	(3301-6500)	(219-DH-02)
(292-EBL)	(6501-9500)	(3301- 6500)*
(292-EJD)	(9501-101300)	(329-DH-02)
(292-4TA)	(101301-151500)	(6501-250500)
(292-5TA)	(151501-201250)	(329-DH-03)
		(250501-353000)

*219 Diesel engine used on 4400 Export Combine only.

4420	Gasoline	Diesel
		(329-DH-03)
		(470001-615521)
		(359-DH-01)
		(611939-)

Type..... 4-stroke cycle,
4 or 6 cylinder-in-line, valve-in-head

Cubic inch displacement and brake horsepower

Gasoline

292-9BS	(4785 cm ³)	292 cu. in.	(68.63 kW)	92 hp
292-1CL	(4785 cm ³)	292 cu. in.	(68.63 kW)	92 hp
292-1DO	(4785 cm ³)	292 cu. in.	(68.63 kW)	92 hp
292-EBL	(4785 cm ³)	292 cu. in.	(70.87 kW)	95 hp
292-EJD	(4785 cm ³)	292 cu. in.	(70.87 kW)	95 hp
292-4TA	(4785 cm ³)	292 cu. in.	(70.87 kW)	95 hp
292-5TA	(4785 cm ³)	292 cu. in.	(70.87 kW)	95 hp

Diesel

219M53HC	(4785 cm ³)	219 cu. in.	(52 kW)	70 hp
219DH-02	(4785 cm ³)	219 cu. in.	(52 kW)	70 hp
329DH-02	(5391 cm ³)	329 cu. in.	(70.87 kW)	95 hp
329DH-03	(5391 cm ³)	329 cu. in.	(74.5 kW)	100 hp
359DH-01	(5883 cm ³)	359 cu. in.	(74.5 kW)	100 hp

Bore and stroke, inches

Bore	Stroke
219 (102.11 mm)	4.02 (110 mm) 4.33
292 (78.5 mm)	3.88 (105 mm) 4.12
329 (102.11 mm)	4.03 (110 mm) 4.33
359 (106.5 mm)	4.19 (110 mm) 4.33

Compression ratio:

292 8.0 to 1
219, 329 16.3 to 1
359 17.4 to 1

Firing Order 292, 329, 359 1-5-3-6-2-4
219..... 1-3-4-2

Valve Clearance:

	(hot or cold)
Gasoline	Intake Exhaust
292 hydraulic lifters 1 turn down from zero lash
Diesel	(hot or cold)
219, 329, 359 (0.356 mm) 0.014 in. (0.457 mm) 0.018 in.

Engine speeds: (normal slow idle) (Fast idle with separator engaged)

Gasoline . 292 550 rpm 2625 rpm
Diesel 329 1200 rpm 2625 rpm

Injection pump timing TDC
Distributor timing 550 rpm 4° Mark
Distributor point gap (0.406 mm) 0.016 in.
Distributor cam dwell 31° to 34°
Spark plug gap (0.889 mm) 0.035 in.
Spark plug size (-F 9BS)
(Gasket Seat) 14 mm
Spark plug size (F ICL-)
(Tapered Seat) 14 mm

Cooling System:

Type Single pressure with centrifugal pump (0.5 bar) (7 psi) - closed system without air conditioning. Surge tank equipped with air conditioning.

Fuel System:

Type Direct Injection Distributor
Air Cleaner Dry Type with Precleaner

Electrical System:

Battery voltage 12 volts
Battery specific gravity at full charge (corrected at (27°C) 80°F 1.260 (±0.010)
Battery terminal grounded Negative
Alternator regulation Voltage regulator

Clutch:

Type: (254 mm) 10-inch 4400 (-250500),
(279 mm) 11-inch 4400 (250501-) and
4420. Dry disk-type mechanically actuated by
foot pedal.

Transmission:

Type: Automotive spur gear with four forward and
one reverse speed. Transmission is equipped
with safety start switch.

Final Drive:

Type: Pinion and ring gear
Ratios 10 to 82, 13 to 89

Steering:

Type: Full power hydrostatic steering

Brakes:

Type: (152 mm) 9-inch hydraulically actuated disk-
type. Individual brakes controlled by separate
pedals.

Hydraulic System:

Type: Open-center, constant-flow system.
Pump: Cessna gear-type.
Relief pressure (143 bar) 2100 psi
Flow rates (at 2500 to 2650 rpm):
Main System (37 m³/s) 5.90 gpm
Steering System
(-201250) (17 m³/s 2.75 gpm
(201251-) (20 m³/s) 3.20 gpm

Capacities:

Cooling System: (Add [1.4 L] 1-1/2 Qts. for heater)
Gasoline - 292 (23.8 L) 25 U.S. Qts.
Diesel - 219 (21.9 L) 23 U.S. Qts.
329, 359 (26.6 L) 28 U.S. Qts.

Engine Crankcase: (Includes oil filter)
Gasoline - 292 (4.73 L) 6 U.S. Qts.
Diesel - 219 (6.6 L) 7 U.S. Qts.
329 (9.5 L) 10 U.S. Qts.
359 (11.5 L) 12 U.S. Qts.

Fuel Tank (170 L) 45 U.S. Gals.
Transmission (6.6 L) 14 U.S. Pts.

Final Drives:
Regular duty (3.8 L) 8 U.S. Pts. each
Heavy duty (4.9 L) 10 U.S. Pts. each
Hydraulic system (including lines and
components) (16.2 L) 17 U.S. Qts.
Hydraulic brake master
cylinder (0.47 L) 1 U.S. Pts.

Weight (less header) (4470 kg) 9,854 lbs.

**GROUND SPEED CONTROL RANGE IN (km/h) MPH
(13 to 89 RATIO)**

Size	Tire Type	Ply Rating	1st Gear (km/h) mph	2nd Gear (km/h) mph	3rd Gear (km/h) mph	4th Gear (km/h) mph	Reverse Gear (km/h) mph
16.9-26	Cleat (R-1)	8	(1.1 to 2.9) .7 to 1.8	(2.3 to 5.8) 1.4 to 3.6	(4.5 to 11.6) 2.8 to 7.2	(8.9 to 23.2) 5.5 to 14.4	(2.6 to 6.6) 1.6 to 4.1
18.4-26	Cleat (R-1)	6	(1.1 to 3.1) .7 to 1.9	(2.4 to 6.1) 1.5 to 3.8	(4.7 to 12.1) 2.9 to 7.5	(9.3 to 24.3) 5.8 to 15.1	(2.6 to 6.9) 1.6 to 4.3
18.4-26	Cleat (R-1)	10	(1.1 to 3.1) .7 to 1.9	(2.4 to 6.1) 1.5 to 3.8	(4.7 to 12.2) 2.9 to 7.6	(9.5 to 24.6) 5.9 to 15.3	(2.7 to 6.9) 1.7 to 4.3
18.4-26	Low Profile (R-3)	6	(1.1 to 3.1) .7 to 1.9	(2.3 to 6.0) 1.4 to 3.7	(4.7 to 11.9) 2.9 to 7.4	(9.2 to 24.0) 5.7 to 14.9	(2.6 to 6.8) 1.6 to 4.2
18.4-26	Cane & Rice (R-2)	8 and 10	(1.29 to 3.2) .8 to 2.0	(2.4 to 6.3) 1.5 to 3.9	(4.8 to 12.6) 3.0 to 7.8	(9.7 to 25.3) 6.0 to 15.7	(2.7 to 7.1) 1.7 to 4.4
23.1-26	Cleat (R-1)	8	(1.3 to 3.4) .8 to 2.1	(2.6 to 6.6) 1.6 to 4.1	(5.2 to 13.2) 3.2 to 8.2	(10.2 to 26.6) 6.3 to 16.5	(2.9 to 7.4) 1.8 to 4.6
23.1-26	Cane & Rice (R-2)	8	(1.3 to 3.5) .8 to 2.2	(2.7 to 6.9) 1.7 to 4.3	(5.3 to 14.0) 3.3 to 8.7	(10.8 to 28.0) 6.7 to 17.4	(3.1 to 7.9) 1.9 to 4.9

All information, illustrations, and specifications contained in this technical manual are based on the latest information available at time of publication. The right is reserved to make changes at any time without notice.

DIMENSIONS

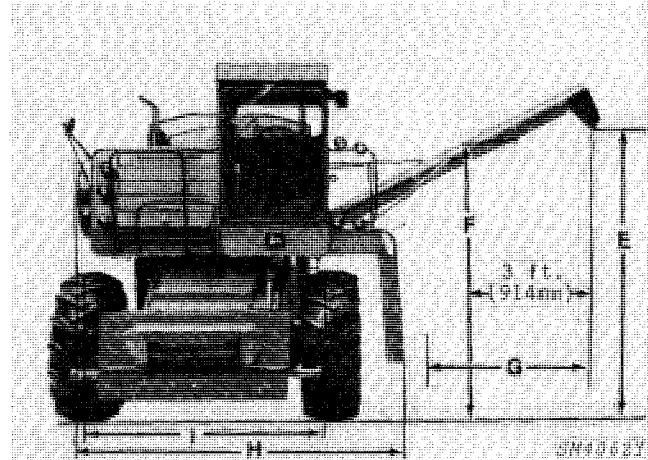
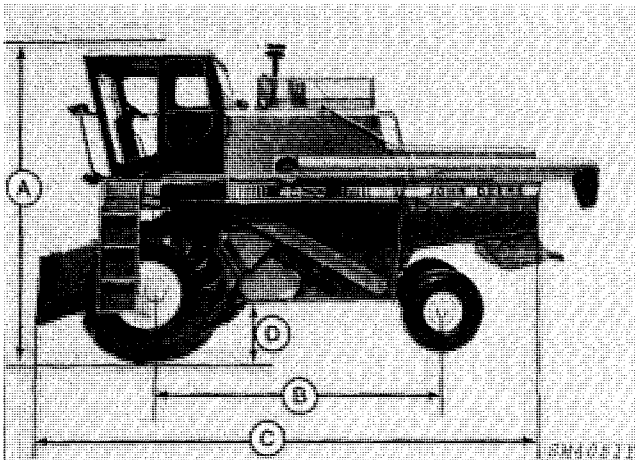

Dimensions are with combine equipped with standard equipment tires.

- | | |
|---|---|
| <p>A. Height..... (3 582 mm)
(11 ft. 9 in.)</p> <p>B. Wheelbase (3 277 mm)
10 ft. 9 in.</p> <p>C. Length
With Auger In The Rear Position:**†
Separator Only (6 655 mm)
21 ft. 10 in.</p> <p>With Auger In The Out Position:**
Separator Only (6 147 mm)
20 ft. 2 in.</p> <p>D. Ground Clearance* 432 mm
17 in.</p> <p>E. Unloading Auger Discharge
Height* (2 895 mm)
9 ft. 6 in.</p> | <p>F. Unloading Auger Clearance Height* . (2 768 mm)
9 ft. 1 in.</p> <p>G. Unloading Auger Reach..... (1 702 mm)
5 ft. 7 in.</p> <p>Header Size Used With Measurement .. (6 096 mm)
20 ft.</p> <p>H. Width (3 048 mm)
10 ft.</p> <p>I. Wheel Tread - For Drive Wheel or Steering Wheel
Tread Widths Refer to "Combine Wheel Spacing".</p> |
|---|---|

**Add (127 mm) 5 in. for long-length feeder house.
†Add (304 mm) 12 in. for a straw chopper and (889 mm) 2 ft. 11 in. for a straw spreader

*With standard tires 18.4-26 (R-1)
Add for optional tires:
18.4-26 (R-2) (25.4 mm) 1.0 in.
23.1-26 (R-1) (50.8 mm) 2.0 in.
23.1-26 (R-2) (101.2 mm) 4.0 in.

Group 05

DIAGNOSING AND TESTING PROCEDURES

To prevent unnecessary loss of time and money, use the following seven steps for a quick and accurate method of locating troubles:

1. Know The Unit

In other words, "Do your Homework". Study the Operator's Manual and this manual to know how the individual components work and what their function is in the overall system.

Keep up with the latest service information. Read and then file in a handy place. Record the Service Information Bulletin numbers on the pages provided in the front of this manual. Information received today may have the cause and remedy of a problem being encountered.

2. Consult The Operator

Ask the operator how the combine was performing when it started to fail. Find out what was unusual about it.

Also find out if any "do-it-yourself" service was performed. (You may find the trouble somewhere else, but you should know if any corrective measures have already been taken.)

Ask how the combine is used and how often it is serviced. Many problems are caused by poor maintenance or abuse.

3. Operate The Combine

If the combine is operable, operate it yourself. Don't rely completely on the operator's story - check it yourself.

Are gauges reading normal? If not, maybe the component being monitored is not functioning correctly or the gauge is faulty.

How's the performance? Is the action perhaps too fast or too slow, erratic, or none at all?

Do the controls feel solid or "spongy"? Do they seem to be "sticking"?

Do you smell or see any signs of smoke?

Do you hear any unusual sounds? Where?

4. Inspect The Combine

Get off the combine and make a visual check. Use your eyes, ears, and nose to spot any signs of trouble.

Look closely at the components. Inspect for cracked welds, loose hardware, damaged linkages, worn or broken lines, etc.

During the inspection, make notes of all the trouble signs.

5. List The Possible Causes

With the information obtained during steps 1 through 4, make a list of the possible causes.

What were the signs you found while inspecting the combine? What is the most likely cause?

6. Reach Some Conclusions

Look over the list of possible causes and decide which are most likely and which are easiest to verify.

Review the "Diagnosing Malfunctions" section as a helpful guide.

Reach your decision on the probable causes and plan to check them first.

7. Test Your Conclusions

Before repairing components in the system, test your conclusions to see which are correct.

Some of the possible causes may be verified without further testing. Check these possibilities first.

Test will narrow the remaining list of possible causes and soon the actual cause(s) of trouble will be pinpointed.

With the cause(s) accurately located, it is now a simple matter to remove and repair the component(s) at fault.

Group 10 TUNE-UP AND ADJUSTMENT

GENERAL INFORMATION

Before tuning up a combine engine, determine whether a tune-up will restore operating efficiency. When there is doubt, the following preliminary tests will help determine if the engine can be tuned up. If

the condition is satisfactory, proceed with the tune-up. Choose from the following procedure only those necessary to restore the combine.

PRELIMINARY ENGINE TESTING

Operation	Specification	Section Reference
Compression Test (Minimum readings at cranking speed)		
Gasoline	292..... (896 kPa) 130 psi	
Diesel	219 and 329 (2 413 kPa) 350 psi	Section 220
	359..... (2 100 kPa) 300 psi	

The most important factor in compression readings is the difference between cylinders. This difference must be no more than (345 kPa) 50 psi in diesel engines or no more than (138 kPa) 20 psi in gasoline engines.

ENGINE TUNE-UP

Operation	Section Reference
Air Intake System	
Check system for leaks
Exhaust System	
Check system for leaks. Check for restricted muffler or exhaust pipe
Crankcase Vent	
Check for restrictions
Cooling System	
Clean rotary screen, radiator core, and air conditioning condenser
Clean and flush system and check thermostat.....	Section 20
Check radiator cap	Section 20
Inspect all hoses

ENGINE TUNE-UP—Continued

Operation	Section Reference
Cylinder Head and Valves	
Torque cylinder head cap screws (in sequence)	Section 20
Set valve clearance	Section 20
Fuel System	
Check fuel tank for water and drain off if required	
Check fuel tank and lines for leaks or restrictions	
Check electric fuel pump pressure	Section 230
Clean sediment bowl and screen	
Service injection nozzles	Section 30
Bleed fuel system	
Check injection pump timing	Section 30
Replace fuel filter(s)	
Electrical System	
Clean and tighten battery cables and connections	
Check alternator belt tension	
Check alternator output	Section 240
Check neutral safety start switch operation	Section 240
Check starter draw	Section 240
Check battery voltage	Section 240
Inspect all wiring	

ADJUSTMENTS

Operation	Specification	Section-Group Reference
Brakes		
Adjust brake linkage		60-10
Inspect brake linings		60-10
Clutch		
Check smoothness of clutch		
Adjust clutch linkage	(25 mm) 1-inch pedal free travel	50-05
Power Steering		
Check smoothness of steering		
Hydraulic System		
Check each hydraulic function		
Inspect filter, oil lines, and hoses		
Tires		
Check tire inflation		
Tighten Accessible Bolts		See Torque Chart below

TORQUE CHART

Bolt Diameter	Plain Head*		Three Radial Dashes*		Six Radial Dashes*	
	N·m	ft-lbs	N·m	ft-lbs	N·m	ft-lbs
1/4 in. (6.35 mm)	8	6	14	10	19	14
5/16 in. (7.93 mm)	18	13	27	20	41	30
3/8 in. (9.53 mm)	31	23	47	35	70	50
7/16 in. (11.11 mm)	47	35	75	55	110	80
1/2 in. (12.70 mm)	75	55	115	85	160	120
9/16 in. (14.29 mm)	100	75	175	130	240	175
5/8 in. (15.88 mm)	140	105	230	170	325	240
3/4 in. (19.05 mm)	250	185	410	300	575	425
7/8 in. (22.23 mm)	220**	160	600	445	930	685
1 in. (25.40 mm)	340**	250	900	670	1400	1030

*The types of bolts and cap screws are identified by head markings as follows:

Plain Head: regular machine bolts and cap screws.

3-Dash Head: tempered steel high-strength bolts and cap screws.

6-Dash Head: tempered steel extra high-strength bolts and cap screws.

**Machine bolts and cap screws 7/8-inch and larger are sometimes formed hot rather than cold, which accounts for the lower torque.

CARE AND MAINTENANCE OF BELTS AND CHAINS

BELTS

V-belts are an important part of a combine or header. Their care and maintenance is important. A V-belt transmits power by friction and a wedging action against the sheaves. Therefore, proper belt tension and the condition of the sheave sidewalls are of primary importance.

Since the power is transmitted between the belts and the sides of the sheave, look there for signs of wear. All belts and sheaves wear with use. Normal wear can be recognized as even wear—both on the

belt and the sides of the sheave. It is the unusual signs of wear to look for and correct.

When checking belts remember that many belts, reported as being defective, have actually been damaged by a bad sheave, misaligned drive, or some faulty mechanical component of the machine.

Examples of Unusual Wear

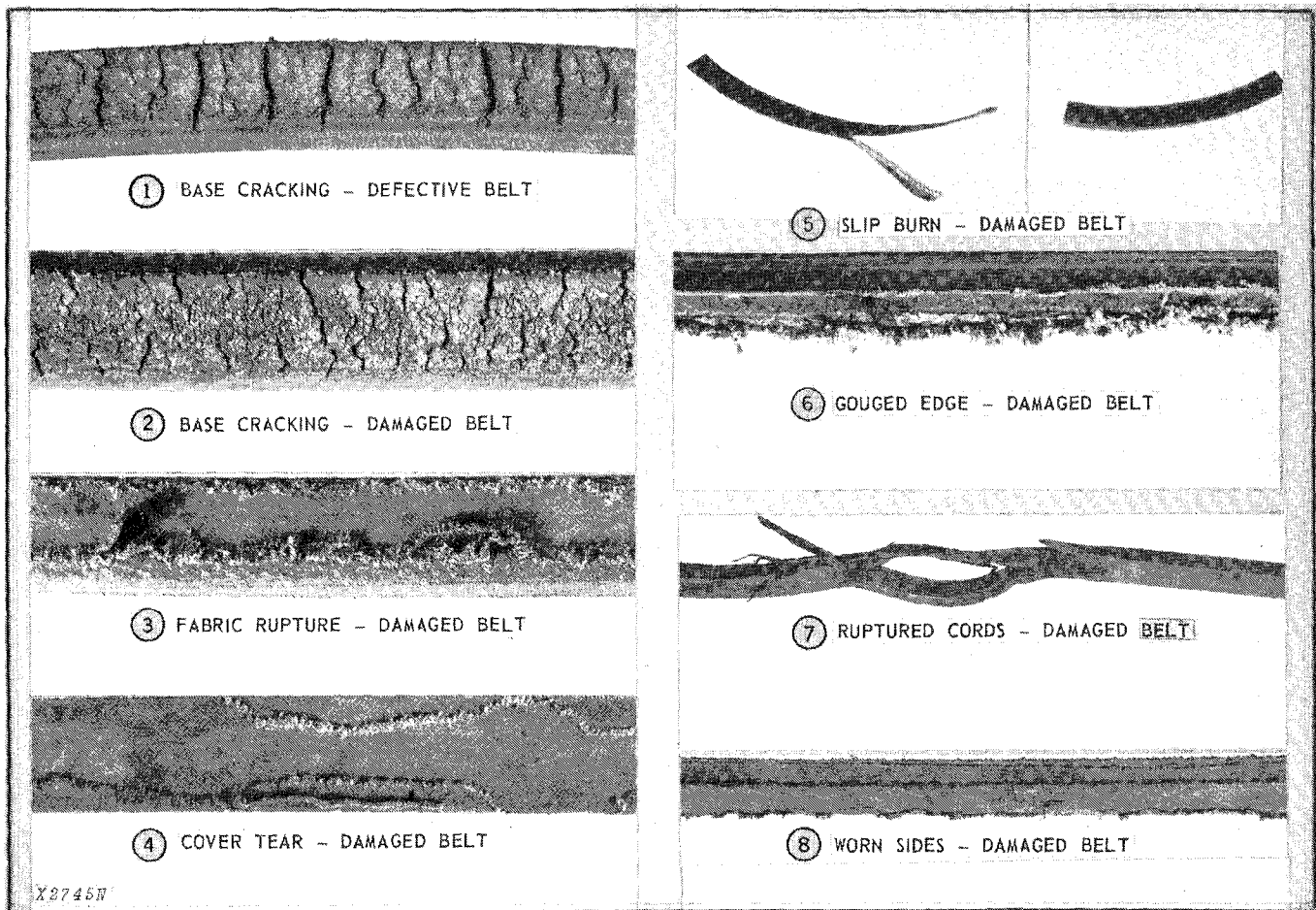

Fig. 1-Examples of Wear on V-Belts

Base Cracking—Excessive cross cracking (1, Fig. 1) extending into the rubber on the base of a belt having little or no side wear, indicates that the belt has been run a relatively short time and therefore must be defective. Small cracks which are in the cover material only do not indicate belt failure.

If the sidewalls show substantial wear, the belt shouldn't be classified as being defective. Actually, the cracks in the base of the belt show that it has been exposed to weather to the extent that the inner fabric is beginning to rot.

Fabric Rupture—A fabric rupture (3) (Fig. 1) can be caused by operating a belt over badly worn sheaves, by too much tension which forces the belt down into the grooves, or by foreign objects falling into the sheave groove while the drive is operating.

In cases such as this, check condition of the sheaves. Avoid prying belts onto sheaves.

Cover Tear—A tear in the cover of a belt (4) (Fig. 1) is caused by the belt accidentally coming into contact with some part of the machine. It is no fault of the belt or its construction.

In many cases, such failure is due to belts running too loose, allowing them to “throw-out” centrifugally, so that they rub on parts of the machine. Proper belt tension would prevent this from happening.

NOTE: A slight raveling of the belt covering at the splice does not indicate premature failure. Cut off the raveling if the cover peels at the lap.

Slip Burn—This belt (5) (Fig. 1) has been ruined by being operated too loose. The belt slipped under load, and, when finally it grabbed, it snapped.

Check belt tension frequently. Turn drives over by hand to make sure they are free. Advise operators to clear machines of crop before stopping to avoid overloading drives when starting up again.

Gouged Edge—A gouged edge in a belt (6) (Fig. 1) is caused either by a damaged sheave or interference with some part of the machine.

Check the condition of the sheaves. Make sure belt does not rub on any part of the machine while operating.

Burn Due to Locked Drive—A burned area in a belt is an indication that the drive locked, causing the belt to slip on the sheave.

Prevent drive from locking by checking the tension of any chain drives in the drive train. Avoid overloading and plugging the machine. **Never** attempt to unplug a machine with power without first cleaning it out. Lubricate the machine at the specified intervals to prevent bearing seizure.

Worn Sides—Badly worn sides of a belt (8) (Fig. 1) result from long operation without enough tension. The sides will be worn and the entire circumference will be slightly burned.

Check belt tension. Also, check sheaves for incorrect alignment.

Defective Belts

Excessive Stretch—A belt that stretches excessively is one that stretches beyond the tightener adjustment provided to take up normal belt stretch. If this condition occurs, it will usually develop within the warranty period.

Lumpy Belts—Lumpy belts usually occur and are more noticeable on variable speed drives and other high-speed belt installations. The result is excessive vibration. If belts are not relieved of tension while machine is stored, they will often cause temporary vibration upon start up. Give them time to straighten out.

Internal Cord Failure—Failure of one or more of the internal tension cords will result in the belt rolling over in the sheaves. (Cords can be broken by prying a new belt over sheaves.)

Improper Length—It is possible for belts either too long or too short to be shipped accidentally in service parts orders. Such belts would not pass the line run-in for new machines at the factory.

Belt Replacement

Here are a few general facts to know when replacing V-belts.

Replace Matched Sets—Never replace just one belt of a matched set. Never install individual belts from matched sets. Install the complete matched set only.

Check Condition of Sheaves—Always check the condition of all sheaves before replacing a belt. Check the sheaves for chips, cracks, bent sidewalls, rust, corrosion, etc. V-belts must have a smooth, dry surface to grip in order to deliver full power. Replace any sheaves that are found to be defective.

Check Sheave Alignment—Misaligned sheaves will result in shortened belt life. Use a straightedge or cord to check sheave alignment as follows:

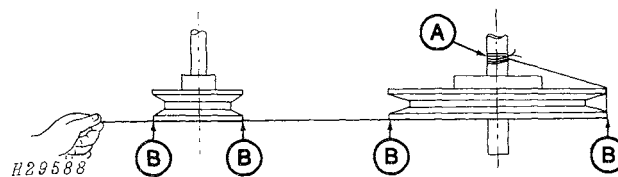

A—Tie Cord To Shaft
B—Cord Must Touch Sheave At Arrows

Fig. 2—Checking Sheave Alignment

1. Position straightedge or cord (Fig. 2) so it touches sheaves at all points. Shafts must be parallel.
2. Rotate each sheave a half revolution and note whether the contact of either sheave with the straightedge is disturbed. If so, it indicates a bent shaft or wobbling sheave.

Belt Installation

Always practice the following when installing new belts.

1. Before installing any new belt, move the adjustable tightener to the position where it provides the least tension when the belt is installed. In some cases, it may be necessary to remove the tightener to install the belt.
2. Examine sheaves for chips, cracks, bent sidewalls, rust, corrosion or other damage.
3. Check sheaves for alignment.
4. Place the belt in the sheave groove by hand.

IMPORTANT: Never pry or force a belt onto the sheave with screwdrivers, crowbars, wedges, etc. Damage to the belt and drive can result.

Belt Tension Adjustment

All belts and sheaves wear with use. For this reason, adjustable tightener arrangements are provided in the drive to maintain the proper belt tension.

More belts fail from under tension than over tension. To carry their full load V-belts must be kept taut so they grip the full arc of contact with the sheave. Some belts may snap in two from a crack-the-whip effect caused by operating the belt too loose. Loose belts slip, heat, and burn, causing unnecessary wear and damage.

Belts with spring-loaded idler will frequently appear quite loose but should be tightened only as instructed in the operator's manual.

However, V-belts must not be excessively tight. When belts are too tight, bearings and sheaves heat up even though well lubricated. Too much tension stretches and weakens belts.

Proper Belt Tension—After a new V-belt has been installed, adjust belt tension as follows:

1. Apply tension as instructed in the machine operator's manual or until the belt appears snug. Run the machine long enough for the belt to seat properly in the grooves.

NOTE: All new belts have an initial stretch. It will be necessary to adjust the tension at shorter intervals until the belt is properly seated, and the initial stretch is eliminated.

2. Stop the machine. Adjust the belt until it has the proper tension as described in the machine operator's manual or use the following "slap test." Slap the belt sharply with your hand. It must feel springy and alive. A dead, lifeless feel means the belt is too loose and must be tightened.

3. Advise owner to check belt tension as instructed in the operator's manual. Under no circumstances should a belt be allowed to operate loose.



CAUTION: Never attempt to check or adjust belts while the machine is running.

Do Not Use Belt Dressing

Belt dressing is not recommended on any belt, V- or flat, at any time. Most dressings contain chemicals which tend to soften belts. While this softening process actually does increase the friction between the belt and sheave grooves, the result is only temporary.

Belt Cleaning Instructions

Remove grease and oil as quickly as possible before they can penetrate deeply into the belt, causing rapid deterioration.

Clean belts by wiping them with a clean cloth. Use a non-flammable cleaner or solvent to remove excessive grease and oil. Water and a detergent soap can be used, but it is not as satisfactory as a non-flammable cleaner.



CAUTION: Do not attempt to clean the belts while the machine is running. Never use flammable cleaning solvents.

Belt Storage Instructions

Proper belt storage is as important for new belts in your parts department as it is for those on the customer's machines.

In the Shop—Store new belts as follows to keep them factory-fresh for your customers.

1. Store belts in a clean, cool, dry atmosphere. Undue shrinkage or deterioration may occur if belts are piled on damp floors or stored near radiators.
2. Keep belts away from sun and heat.
3. Do not place belts in bins for long periods. To do so might distort the shape of the belt.
4. Do not hang belts on small pegs or nails. Heavy belts can be weakened due to distortion from such a practice.
5. Do not break matched sets.

On Customer's Machines—Pass along the following tips about storing belts to your customers:

1. If a belt is not to be removed, relieve belt tension by loosening tightener adjustment. This is necessary to prevent belt from "setting" or developing unequal stresses that might lead to early failure.

2. If possible, remove all belts. Thoroughly clean them as described earlier in this article. Then store them in a cool, clean, dry atmosphere.

3. If belts have been removed, coat sheave grooves with anti-rust compound or grease prior to storage. Remove all rust preventives before installing the belts and starting machine. Sheave grooves can also be protected with a section of discarded belt tied in place.

4. Protect all movable or sliding parts of variable speed drives by lubricating them thoroughly to prevent corrosion due to moisture.

CHAINS

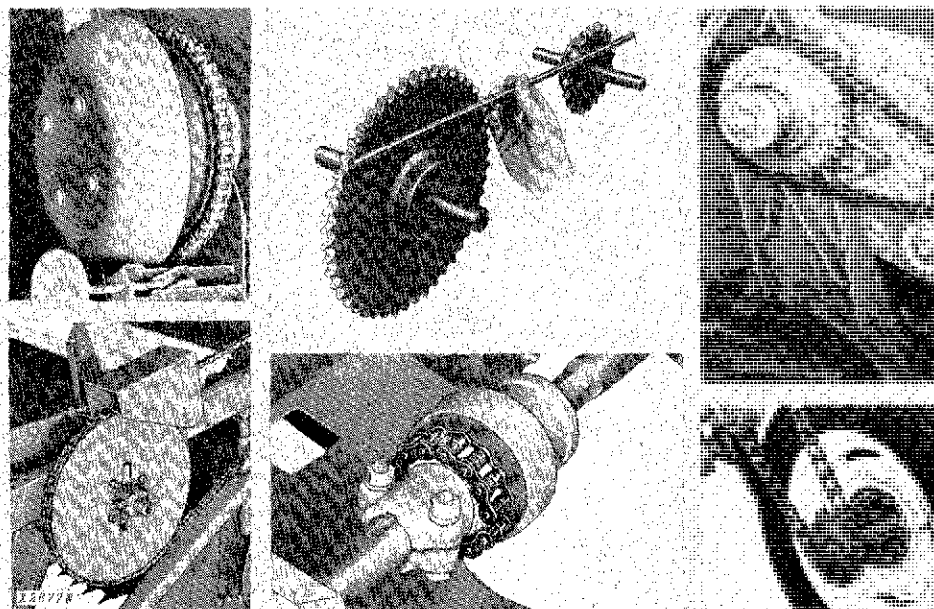

Fig. 3-Chain Drives

A chain drive will provide long, trouble-free operation if properly installed and serviced. Here is some information to pass on to your customers so that they can be certain chain drives on their machines will operate with minimum maintenance and low upkeep costs.

Checking Chain Tension

Check chains frequently during first several hours of operation.

Adjust tightener sprockets or blocks to maintain proper chain tension. The amount of slack in a chain must be approximately 2 percent of the distance between the centers of the drive and driven sprockets.

For example, if the center distance between a drive and driven sprocket is (254 mm) 10 inches, the slack in the chain should be (6 mm) 1/4 inch.

This is measured in center of span of chain opposite tightener sprocket. Slack must be removed from tightener sprocket side of chain before measuring slack side of chain.

Chains which are too loose will cause rapid and excessive wear to chain rollers, sprocket teeth, and possibly machine components that chain is driving.

Chains that are too tight may result in damage to bearings and shafts. Too much chain tension can also cause rapid wear of chain itself.

Section 20

219 AND 329 DIESEL ENGINE REPAIR

CONTENTS OF THIS SECTION

<p>GROUP 00 - SPECIFICATIONS AND SPECIAL TOOLS</p> <ul style="list-style-type: none"> Specifications 20-00-2 Special Tools 20-00-5 <p>GROUP 05 - CYLINDER HEAD, VALVES AND CAMSHAFT</p> <ul style="list-style-type: none"> Preliminary Valve Checks 20-05-1 Checking Valve Clearance 20-05-1 Checking Valve Lift 20-05-2 Cylinder Head and Valves 20-05-3 Rocker Arm Assembly <ul style="list-style-type: none"> Removal 20-05-3 Inspection and Repair 20-05-3 Assembly and Installation 20-05-3 Camshaft 20-05-5 <ul style="list-style-type: none"> Checking Camshaft End Play 20-05-5 Removal 20-05-5 Inspection and Repair 20-05-5 Installation 20-05-5 <p>GROUP 10 - CYLINDER BLOCK, LINERS, PISTONS AND RODS</p> <ul style="list-style-type: none"> Diagnosing Malfunctions 20-10-1 Pistons 20-10-1 <ul style="list-style-type: none"> Access 20-10-1 Inspection and Repair <ul style="list-style-type: none"> Piston Rings and Ring Grooves 20-10-3 Piston Head, Ring Lands and Piston Skirt 20-10-4 Piston Pins 20-10-4 Connecting Rods <ul style="list-style-type: none"> Removal 20-10-4 Inspection and Repair 20-10-4 Connecting Rod Bearings 20-10-6 Cylinder Liners <ul style="list-style-type: none"> Removal, Inspection, and Repair 20-10-6 Deglazing Cylinder Liners 20-10-7 Block 20-10-8 	<p>GROUP 15 - CRANKSHAFT, MAIN BEARINGS AND FLYWHEEL</p> <ul style="list-style-type: none"> Diagnosing Malfunctions 20-15-1 Inspection and Repair <ul style="list-style-type: none"> Checking Crankshaft Endplay 20-15-1 Damper Pulley 20-15-2 Front Wear Sleeve 20-15-2 Crankshaft Gear 20-15-2 Flywheel 20-15-3 Rear Crankshaft Oil Seal, Housing and Wear Sleeve 20-15-3 Main Bearings 20-15-4 Thrust Bearings 20-15-5 Crankshaft Journals 20-15-6 Installation <ul style="list-style-type: none"> Main Bearings and Crankshaft 20-15-6 Rear Wear Sleeve 20-15-7 Rear Oil Seal and Housing 20-15-7 Crankshaft Gear, Front Wear Sleeve and Oil Seal 20-15-8 Timing Gear Train 20-15-9 <p>GROUP 20 - LUBRICATION SYSTEM</p> <ul style="list-style-type: none"> Checking Oil Pressure 20-20-1 Engine Repair 20-20-1 Assembly 20-20-3 Installation 20-20-3 Crankcase Oil Cooler 20-20-4 Adjusting Oil Pressure 20-20-4 Installation 20-20-5 <p>GROUP 25 - COOLING SYSTEM</p> <ul style="list-style-type: none"> Diagnosing Malfunctions 20-25-1 Radiator and Fan 20-25-1 Water Pump 20-25-1 Thermostat 20-25-5 Installation of Engine Coolant <ul style="list-style-type: none"> Recovery Parts 20-25-6 Rotary Cooling Screen 20-25-7 Engine Coolant Heater 20-25-9 <p>GROUP 30 -</p> <ul style="list-style-type: none"> Linkage Adjustment 20-30-1 Fuel Injection Pump Adjustment 20-30-2
--	--

Group 00

SPECIFICATIONS AND SPECIAL TOOLS

SPECIFICATIONS

Item	New Part Specification	Wear Tolerance
Cylinder Head, Valves, and Camshaft		
Valve clearance		
Intake valve	(0.36 mm) 0.014 inch	
Exhaust valve	(0.46 mm) 0.018 inch	
Valve lift at specified clearance		
Intake valve	(11.68 to 12.44 mm) 0.460 to 0.490 inch	
Exhaust valve	(11.48 to 12.24 mm) 0.452 to 0.482 inch	
Valve springs - compressed		
Valve closed	(46 mm at 23 to 29 kg) 1.81 in. at 52 to 64 lbs	
Valve open	(34 mm at 60 to 69 kg) 1.36 in. at 133 to 153 lbs	
Valve face angle	43-1/2°	
Valve face O.D.		
Intake valve	(44.48 to 44.56 mm) 1.77 to 1.78 inch	
Exhaust valve	(39.47 to 39.73 mm) 1.57 to 1.58 inch	
Valve guide I.D.	(9.51 to 9.53 mm) 0.375 to 0.376 inch	(.025 mm) .001 in.
Valve stem O.D.	(9.44 to 9.47 mm) 0.372 to 0.373 inch	
Valve stem-to-guide clearance	(0.05 to 0.10 mm) 0.002 to .004 inch	(0.15 mm) .006 in.
Valve seat width	(1.57 mm) 0.062 inch	
Valve seat concentricity with guide	(0.05 mm) .002 inch	
Valve seat angle	45°	
Valve height		
Intake valve	(0.58 to 1.19 mm) 0.023 to 0.047 inch	
Exhaust valve	(0.97 to 1.83 mm) 0.038 to 0.071 inch	
Camshaft end play	(0.06 to 0.22 mm) 0.003 to 0.009 in.	(0.38 mm) 0.015 in.
Camshaft thrust plate thickness	(3.96 to 4.01 mm) 0.156 to 0.158 inch	(0.12 mm) 0.005 in.
Camshaft bushing journal O.D.	(56.08 to 56.10 mm) 2.20 to 2.201 inch	(0.02 mm) 0.001 in.
Camshaft bushing I.D.	(55.99 to 56.01 mm) 2.204 to 2.205 inch	
Camshaft bushing-to-journal clearance	(0.07 to 0.12 mm) 0.004 to 0.006 inch	(0.22 mm) 0.009 in.
Cylinder head-to-block	(149 N·m) (14.9 kgm) 110 ft-lbs	

Cylinder Block, Liners, Pistons and Rods

Cylinder liner height	(0.03 to 0.10 mm)	0.001 to 0.004 inch
Piston oil control ring clearance	(0.10 to 0.13 mm)	0.004 to 0.005 inch (0.20 mm) 0.008 in.
Piston O.D.		
Top of skirt-(77 mm) 3.03 inch from		
bottom of piston	(102.08 to 102.10 mm)	4.003 to 4.004 inch
Bottom of skirt-(2 mm) 0.09 from		
bottom of piston	(102.13 to 102.15 mm)	4.005 to 4.006 inch
Cylinder liner	(102.38 to 102.41 mm)	4.015 to 4.016 inch . (0.13 mm) 0.005 in.
Cylinder liner taper	(0.05 mm)	0.002 in.
Piston-to-liner clearance		
Top of skirt	(0.18 to 0.25 mm)	0.007 to 0.010 in.
Bottom of skirt	(0.00 to 0.10 mm)	0.000 to 0.004 in.
Piston pin O.D.	(34.95 to 34.98 mm)	1.376 to 1.377 in. (0.01 mm) 0.0005 in.
Pin bore in piston I.D.	(30.17 to 30.19 mm)	1.188 to 1.189 in. (0.03 mm) .001 in.
Rod pin bushing I.D.	(34.77 to 34.84 mm)	1.369 to 1.372 in. (.05 mm) 0.002 in.
Pin-to-bushing oil clearance	(0.03 to 0.05 mm)	0.001 to 0.002 in. (0.05 mm) 0.002 in.
Connecting rod bearing assembled I.D.	(70.05 to 70.08 mm)	2.750 to 2.751 in.
Connecting rod journal O.D.	(69.99 to 70.01 mm)	2.748 to 2.749 in. Round within (0.008 mm) 0.003 in.
Bearing to journal clearance	(0.05 to 0.13 mm)	0.002 to 0.005 in. (0.15 mm) 0.006 in.

Torques

Connecting rod caps	(90 N·m) 65 ft-lbs
Piston cooling orifices	(9 N·m) 100 in-lbs
Oil pan to block and timing gear	(45 N·m) 35 ft-lbs
Front plate to block	(35 N·m) 25 ft-lbs

Balancer Shafts (219 Diesel Engines Only)

Bearing I.D.	(38.15 to 38.20 mm)	(.076 mm)
	1.502 to 1.504 inch	.0030 inch
Bearing journal O.D.	(38.08 to 38.11 mm)	(.076 mm)
	1.4995 to 1.5005 in.	.0030 inch
Bearing bore	(41.26 to 41.28 mm)	(.076 mm)
(with bearing)	1.6245 to 1.6255 in.	.0030 inch
Bearing to	(.038 to .114 mm)	(.152 mm)
journal clearance	.0015 to .0045 in.	.0060 inch
End play	(0.51 to .203 mm)	(.381 mm)
	0.0020 to 0.0080 inch	0.0150 inch
Thrust plate thickness	(2.97 to 3.02 mm)	(.127 mm)
	.1170 to 0.1190 inch	.0050 inch

SPECIFICATIONS—Continued

Crankshaft, Main Bearings and Flywheel

Item	New Part Specification	Wear Tolerance
Crankshaft end play	(0.05 to 0.20 mm) 0.002 to 0.008 in.	(0.38 mm) 0.015 in.
Main bearing journal O.D.	(9.12 to 9.14 mm) 3.123 to 3.124 in.	Round within (0.08 mm) 0.003 in.
Main bearing assembled I.D.	(9.16 to 9.18 mm) 3.126 to 3.128 in.	
Bearing to journal clearance	(0.05 to 0.13 mm) 0.002 to 0.005 in.	(0.15 mm) 0.006 in.
Crankshaft rear oil seal-to-housing run-out .	(0.15 mm) 0.0060 in.	
Journal taper per inch of journal length	Not affected.....	(0.003 mm) 0.001 in.
Journal out-of-roundness	Not affected.....	(0.08 mm) 0.003 in.

Torques

Damper pulley to crankshaft	(115 N·m) 85 ft-lbs
Main bearing caps	(115 N·m) 85 ft-lbs
Rear crankshaft oil seal housing	(27 N·m) 20 ft-lbs
Flywheel-to-crankshaft	(115 N·m) 85 ft-lbs

Lubrication System

Item	New Part Specification	Wear Tolerance
Engine oil pressure at 2500 rpm	(310 to 448 kPa)	45 to 65 psi
Oil pressure regulating valve spring - compressed	(46 mm at 6.8 kg)	1.69 in. at 15 lbs.

Cooling System

Radiator leakage test	(70 kPa) (.70 bar)	10
Radiator cap pressure	(48 kPa)	7 psi

SPECIAL TOOLS

Cylinder Head, Valves and Camshaft

MATERIALS REQUIRED

JDT 405 High Temperature Grease

NUMBER	USE
*A—JDE-81-1 Flywheel Turning Tool	To rotate the engine flywheel when timing the engine.
*B—JDE-81-4 Timing Pin	

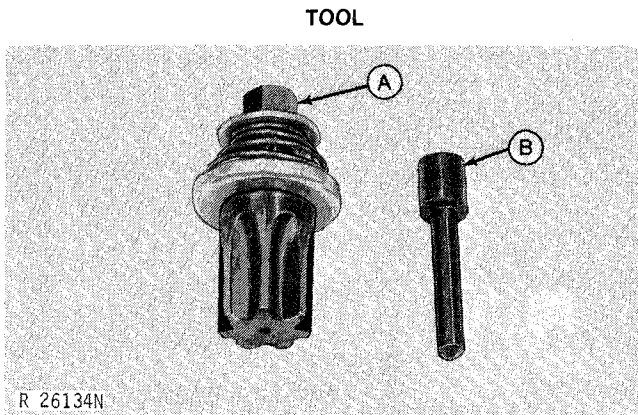

Fig. 1-Engine Rotation Tool Set

*Order from: Service Tools, Box 314, Owatonna MN 55060

Cylinder Head, Valves and Camshaft Special Tools—Continued

TOOL

NUMBER

USE

- *A—D-05058ST Valve Inspection Center To check valves for out-of-round.
- *B—D-17011 BR Valve Guide Cleaning Brush To clean valve guides.
- *C—D-20002W1 Knurling Tool Set To knurl valve guides.

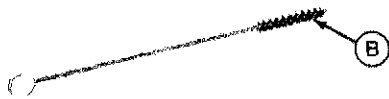
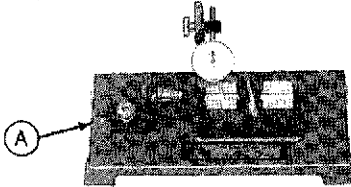
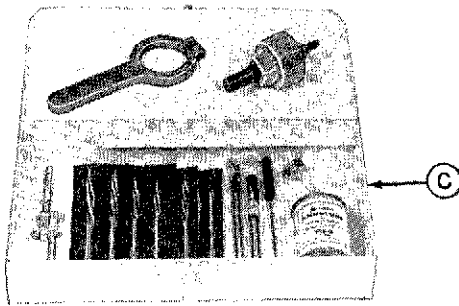

R 26137N

Fig. 2-Special Tools

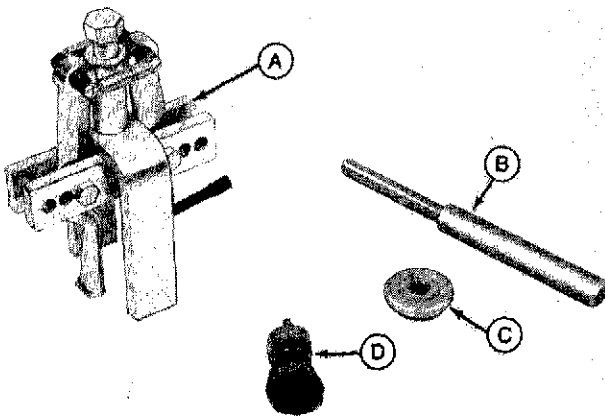

R 27502N

Fig. 3-Special Tools

- *A—JDE-41296 Seat Puller To remove valve seats.
- *B—JDE-7 Driver To install valve seats with JDE-79 Replacement Ring
- *C—JDE-79 Replacement Ring To install valve seats with JDE-7 Driver.
- *D—D-17024 End Brush To clean valve seat and bore.

- *D-15001NU Magnetic Holding Tool Set To hold cam followers away from camshaft.



R 26148N

Fig. 4-D-15001NU Magnetic Holding Tool Set

*Order from: Service Tools, Box 314, Owatonna MN 55060



Suggest:

If the above button click is invalid.

Please download this document

first, and then click the above link

to download the complete manual.

Thank you so much for reading

TOOL

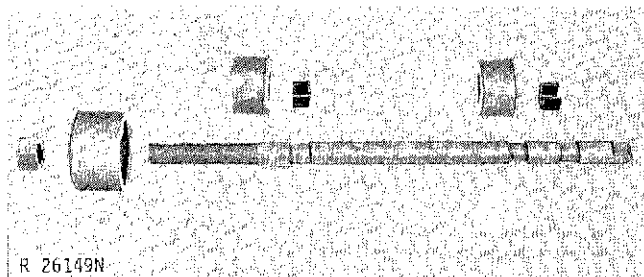

Fig. 5-JDE-6 Camshaft Bushing Replacement Set

NUMBER

*JDE-6 Camshaft Bushing Replacement Set.

USE

To remove and install camshaft bushings.

Cylinder Block, Liners, Pistons and Rods

Cylinder Liner Holding Fixture

See Making Special Tools, p. 20-00-10

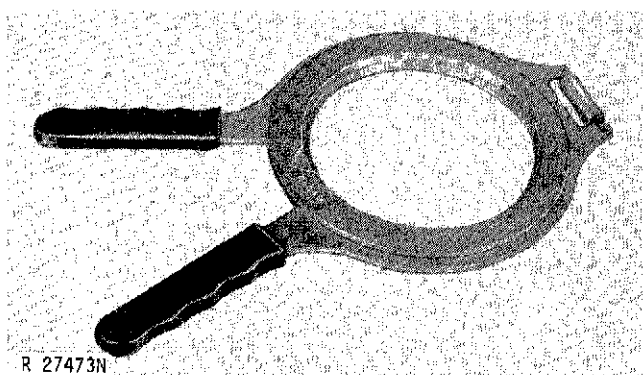

Fig. 6-JDE-45 Ring Expander

*JDE-45 Ring Expander

To install piston rings.

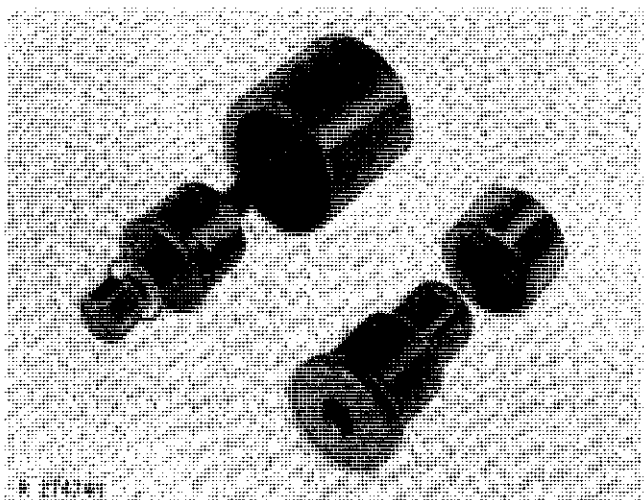

Fig. 7-JDE-98-329 Connecting Rod Bushing Service Set.

*JDE-98-329 Connecting Rod Bushing Service Set

To remove and install connecting rod bushings.

*Order from: Service Tools, Box 314, Owatonna MN, 55060

<https://www.ebooklibonline.com>

Hello dear friend!

Thank you very much for reading.

Enter the link into your browser.

The full manual is available for immediate download.

<https://www.ebooklibonline.com>