

**4050,  
4250, 4450,  
4650 and 4850  
Tractors**



**JOHN DEERE**

**TECHNICAL MANUAL**  
4050, 4250, 4450, 4650 and 4850  
Tractors

TM1259 (01Sep87) English

**TM1259 (01Sep87)**

LITHO IN U.S.A.  
ENGLISH

# 4050,4250,4450,4650 AND 4850 TRACTORS TECHNICAL MANUAL TM-1259 (SEP-87)

## CONTENTS—OPERATION AND TESTS

*This manual covers Tractor Operation and Tests (yellow tabs). Repair (green tabs) is covered in TM-1353 (formerly TM-1257) (4050,4250 and 4450 Tractors), TM-1354 (formerly TM-1258) (4650 and 4850 Tractors), CTM1 (6466 Engines), and CTM7 (Radial Piston Pumps).*

### SECTION 210—GENERAL

Introduction and Safety Information

### SECTION 220—ENGINE OPERATION AND TESTS

Group 05—System Operation

Group 10—System Tests and Diagnosis

### SECTION 230—FUEL/AIR OPERATION AND TESTS

Group 05—Air Intake System

Group 10—Diesel Fuel System

Group 15—Control Linkage

### SECTION 240—ELECTRICAL SYSTEM

Group 05—Electrical System Information

Group 06—Phase I Electrical Wiring Diagrams

Group 07—Phase II Electrical Wiring Diagrams

Group 10—Electrical System Diagnosis

Group 15—Delcotron Charging Circuit

Group 16—John Deere Charging Circuit

Group 20—Starting Circuit

Group 25—Lighting Circuit

Group 30—INVESTIGATOR™ II and Digital  
Tachometer

Group 31—Gauge Cluster Instrumentation

Group 32—Analog Tachometer

Group 35—Accessories Circuit

Group 40—PERFORMANCE TRAK™ I Radar  
Sensor System (Tachometer Version)

Group 41—PERFORMANCE TRAK™ II Radar  
Sensor System (Mini-Monitor)

Group 42—PERFORMANCE TRAK™ III Radar  
Sensor System (Multi-Function  
Monitor)

### SECTION 250—POWER TRAIN (PERMA-CLUTCH TRANSMISSION)

Group 05—QUAD-RANGE™ System Operation

Group 10—PERMA-CLUTCH™ Operation

Group 15—QUAD-RANGE™ Planetary

Group 20—QUAD-RANGE™ Eight-Speed

Group 25—Transmission Oil Pump

Group 30—Transmission Lubrication Valve

Group 35—Transmission Control Valves

Group 40—Differential and Final Drive

Group 45—SYNCRO-RANGE™ Transmission

Group 55—PTO

Group 60—QUAD RANGE™ Transmissions  
Diagnosis

### SECTION 255—POWER SHIFT TRANSMISSION

Group 05—Mechanical Operation

Group 10—Hydraulic Controls

Group 15—PTO, Differential and Final Drives

Group 16—Power Shift Transmission Diagnosis

Group 20—Mechanical Front Wheel Drive

*Continued on next page*

*All information, illustrations and specifications contained in this technical manual are based on the latest information available at the time of publication. The right is reserved to make changes at any time without notice.*

## CONTENTS—OPERATION AND TESTS —CONTINUED

### SECTION 260—STEERING/BRAKES OPERATION AND TESTS

- Group 05—4050, 4250, and 4450 Power Steering
- Group 06—4650 and 4850 Power Steering
- Group 10—Power Brakes

### SECTION 270—HYDRAULIC OPERATION AND TESTS

- Group 05—PERMA-CLUTCH™ Transmission Operation
- Group 10—Power Shift Transmission Hydraulic System Operation and Tests
- Group 15—Main Hydraulic Pump
- Group 20—QUAD-RANGE™ Transmission Hydraulic Valves
- Group 25—Power Shift Transmission Hydraulic Valves
- Group 30—Pressure Control Valve
- Group 35—HYDRACUSHIONED™ Seat
- Group 40—Rockshaft Operation (4050, 4250, 4450)
- Group 45—Rockshaft Operation (4650 and 4850)
- Group 50—Selective Control Valve
- Group 55—Remote Cylinder
- Group 60—QUAD-RANGE Hydraulic Diagnosis
- Group 65—Power Shift Transmission Hydraulic Diagnosis

### SECTION 290—OPERATOR STATION OPERATIONS AND TESTS

- Group 05—Air Conditioning System
- Group 10—Air Conditioning System Tests—Introduction
- Group 11—System Tests Without Timer Relay-Warning Lamps
- Group 12—System Tests With Timer Relay-Warning Lamps
- Group 15—Heating System Operation Tests
- Group 20—HYDRACUSHIONED™ Seat

### SECTION 299—SPECIAL TOOLS

- Group 05—Purchased Tools
- Group 10—Fabricated Tools
- Group 15—Test Equipment Calibration

**<https://www.ebooklibonline.com>**

Hello dear friend!

Thank you very much for reading.

Enter the link into your browser.

The full manual is available for immediate download.

**<https://www.ebooklibonline.com>**

## INTRODUCTION

This manual is part of a total service support program.

### FOS Manuals—reference

### Technical Manuals—machine service

### Component Manuals—component service

*Fundamentals of Service (FOS) Manuals* cover basic theory of operation, fundamentals of troubleshooting, general maintenance, and basic types of failures and their causes. FOS Manuals are for training new personnel and for reference by experienced technicians.

*Technical Manuals* are concise service guides for specific machines. Technical manuals are on-the-job guides containing only the vital information needed by an experienced service technician.

*Component Technical Manuals* are concise service guides for specific components. Component technical manuals are written as stand alone manuals covering multiple machine applications.

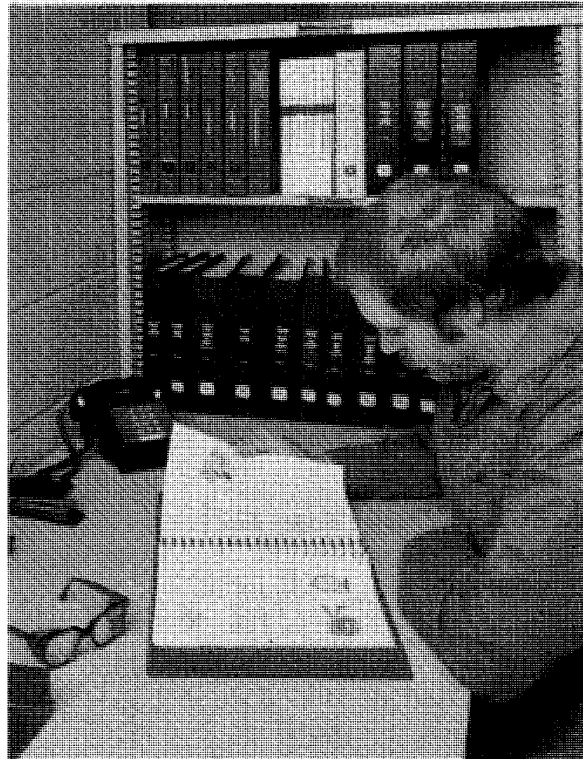

AB6;RW5559 053;INTR02 030785

## FEATURES OF THIS TECHNICAL MANUAL

John Deere ILLUSTRATION format emphasizing illustrations and concise instructions in easy-to-use modules.

Emphasis on diagnosis, analysis, and testing so you can understand the problem and correct it.

Diagnostic information presented with the most logical and easiest to isolate problems first to help you identify the majority of routine failures quickly.

Step-by-step instructions for teardown and assembly.

Summary listing at the beginning of each group of all applicable specifications, wear tolerances, torque values, essential tools, and materials needed to do the job.

An emphasis throughout on safety—so you do the job right without getting hurt.

This technical manual was planned and written for you—an experienced service technician. Keep it in a permanent binder in the shop where it is handy. Refer to it when you need to know correct service procedures or specifications.

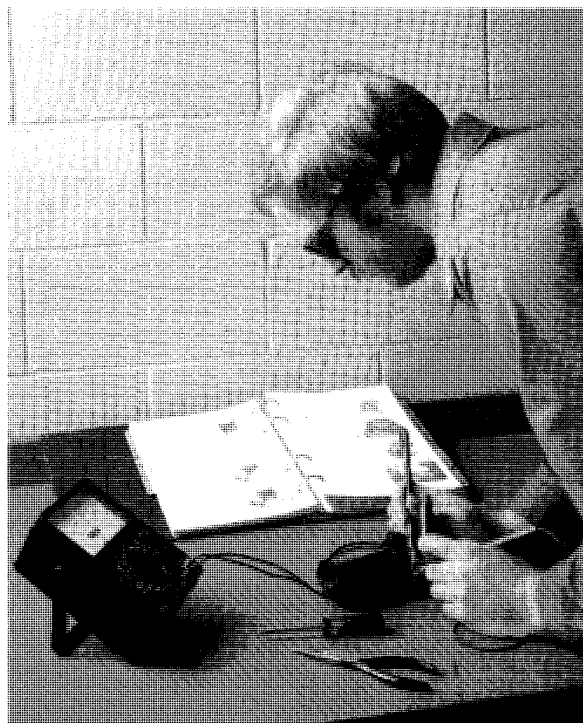

AB6;RW5560 053;INTR03 071085

## RECOGNIZE SAFETY INFORMATION

This is the safety-alert symbol. When you see this symbol on your machine or in this manual, be alert to the potential for personal injury.

Follow recommended precautions and safe operating practices.

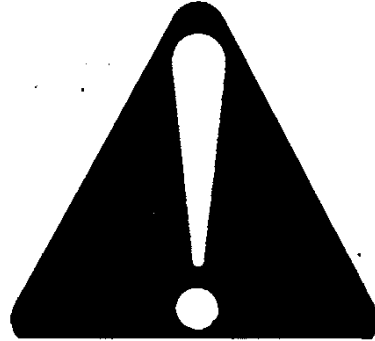

AB6;T81389 053;ALERT 160687

## IMPORTANT

The **IMPORTANT** message identifies potential problems which may cause consequential damage to tractor. Following recommended procedure will instruct technician how to avoid problem.

U10;0101NT 0 101281

## NOTES

The word *NOTE* is followed by a statement that identifies a qualification or exception to a previous statement. A "NOTE" may also identify nice-to-know information pertinent to, but not directly related to previous statement.

U10;0101NT E 101281

## STAY CLEAR OF MOVING TRACTOR

Always place transmission in PARK (A) before dismounting. Leaving transmission in gear with engine stopped will NOT prevent the tractor from moving.

Be sure everyone is clear of tractor and attached equipment before starting engine. Some movement may occur as engine starts.

Never try to get on or off a moving tractor.

When tractor is left unattended, lower implements to the ground (B), stop the engine, and remove the key.

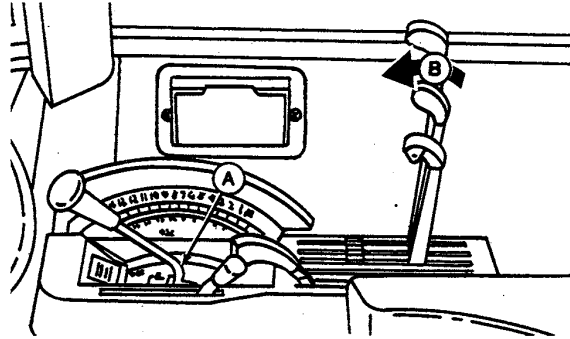

AJ7;RW5696L U01;STAY CLEAR2 200585

## PREVENT MACHINE RUNAWAY

Avoid possible injury or death from machinery runaway.

Do not start engine by shorting across starter terminals. Machine will start in gear if normal circuitry is bypassed.

NEVER start engine while standing on ground. Start engine only from operator's seat, with transmission in neutral or park.

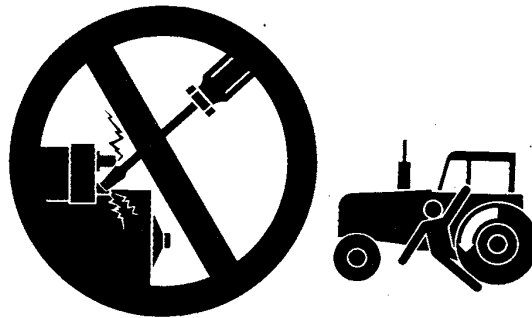

AB6;TS177 053;BYPAS1 210585

### SHIFT TO LOW GEAR ON HILLS

Shift to a low gear (B) before descending a steep hill (A), to improve your control of the tractor with little or no braking. Make sure brake pedals are locked together. Never coast downhill.

When driving on icy or graveled surfaces, reduce speed and be sure tractor is properly ballasted to avoid skidding and loss of steering control.

Additional ballast (C) may be needed for transporting heavy integral implements. When implement is raised, drive slowly over rough ground, regardless of how much ballast is used.

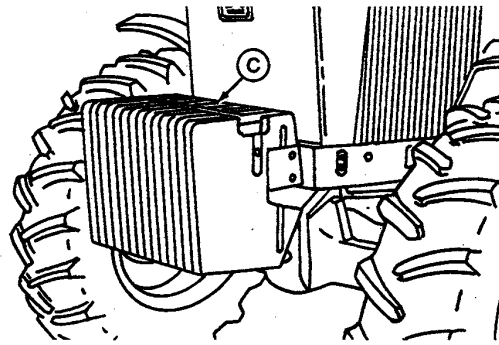
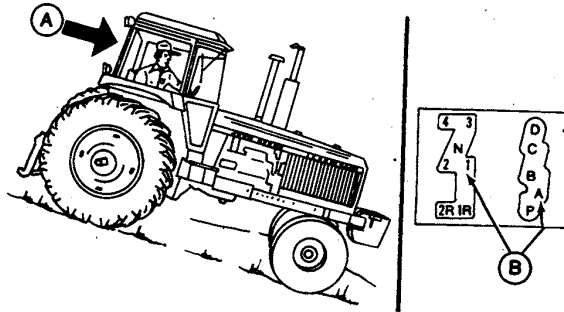

AJ7;RW5692 L,RW5693 L U01;DRIVE SAFE1 281085

### AVOID EXHAUST FUMES

Never run engine in a closed building. Make sure service area is adequately ventilated.

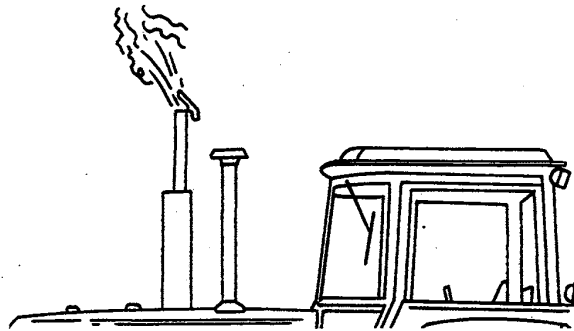

AJ7;RW5703 L U01;AVOID FUMES 090585

### KEEP RIDERS OFF MACHINE

Only allow the operator on the machine. Keep riders off.

Riders on machine are subject to injury such as being struck by foreign objects and being thrown off of the machine. Riders also obstruct the operator's view resulting in the machine being operated in an unsafe manner.



AB6;TS213 053;RIDER 160687

## HANDLE FUEL SAFELY—AVOID FIRES

Handle fuel with care: it is highly flammable. Do not refuel the machine while smoking or when near open flame or sparks.

Always stop engine before refueling machine. Fill fuel tank outdoors.

Prevent fires by keeping machine clean of accumulated trash, grease, and debris. Always clean up spilled fuel.



AB6;TS202 053;FIRE1 230487

## PREPARE FOR EMERGENCIES

Be prepared if a fire starts.

Keep a first aid kit and fire extinguisher handy.

Keep emergency numbers for doctors, ambulance service, hospital, and fire department near your telephone.



AB6;TS186 053;FIRE2 080785

## HANDLE STARTING FLUID SAFELY

Starting fluid is highly flammable.

Keep all sparks and flame away when using it. Keep starting fluid away from batteries and cables.

To prevent accidental discharge when storing the pressurized can, keep the cap on the container, and store in a cool, protected location.

Do not incinerate or puncture a starting fluid container.



AB6;T6098A U 053;FIRE3 160687

## PREVENT BATTERY EXPLOSIONS

Battery gas can explode. Keep sparks and flames away from batteries. Use a flashlight to check battery electrolyte level.

Never check battery charge by placing a metal object across the posts. Use a voltmeter or hydrometer.

Always remove grounded (-) battery clamp first and replace it last.



AB6;TS204 U01;EXPLO 021087

## AVOID ACID BURNS

Sulfuric acid in battery electrolyte is poisonous. It is strong enough to burn skin, eat holes in clothing, and cause blindness if splashed into eyes.

Avoid the hazard by:

1. Filling batteries in a well-ventilated area.
2. Wearing eye protection and rubber gloves.
3. Avoid breathing fumes when electrolyte is added.
4. Avoid spilling or dripping electrolyte.

If you spill acid on yourself:

1. Flush your skin with water.
2. Apply baking soda or lime to help neutralize the acid.
3. Flush your eyes with water for 10-15 minutes. Get medical attention immediately.

If acid is swallowed:

1. Drink large amounts of water or milk.
2. Then drink milk of magnesia, beaten eggs, or vegetable oil.
3. Get medical attention immediately.

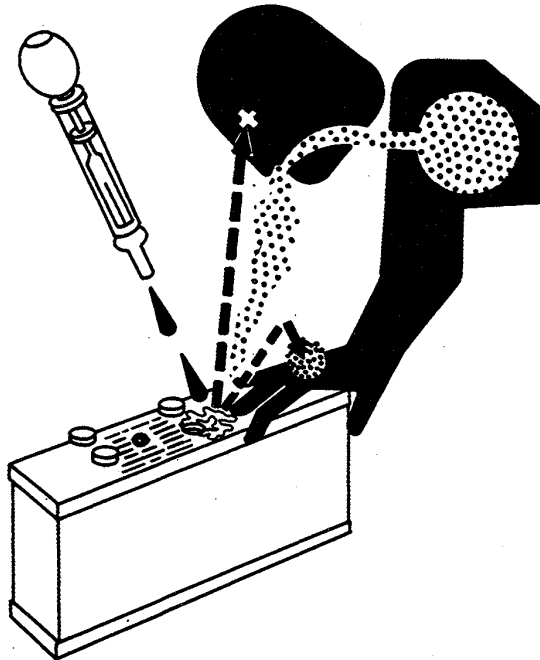

AB6;TS203 U01;ACID 021087

## PROTECT AGAINST NOISE

Prolonged exposure to loud noise can cause impairment or loss of hearing.

Wear a suitable hearing protective device such as earmuffs or earplugs to protect against objectionable or uncomfortable loud noises.

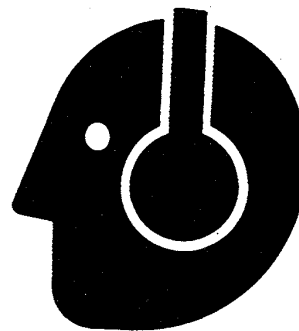

AB6;TS207 053;NOISE 230487

## USE SEAT BELT PROPERLY

Use a seat belt when you operate with a roll-over protective structure (ROPS) to minimize chance of injury from an accident such as an overturn.

Do not use a seat belt if operating without a ROPS.

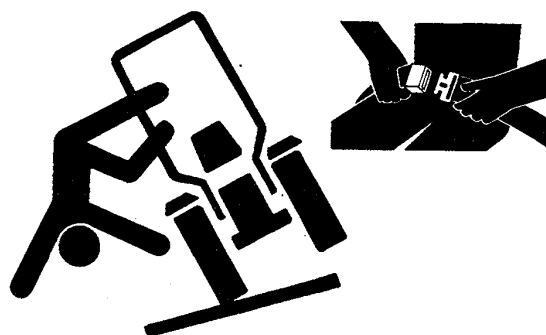

AB6;TS205 053;ROPS1 230487

### WEAR PROTECTIVE CLOTHING

Wear close fitting clothing and safety equipment appropriate to the job.

Prolonged exposure to loud noise can cause impairment or loss of hearing.

Wear a suitable hearing protective device such as earmuffs or earplugs to protect against objectionable or uncomfortable loud noises.

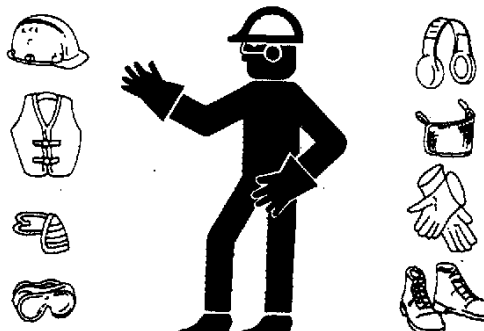

AB6;TS206 053;WEAR 230487

### HANDLE CHEMICALS PROPERLY

SOUND-GARD body air filters (A) are not designed to filter out harmful chemicals. Follow instructions given in the implement operator's manual and those given by the chemical manufacturer when using agricultural chemicals.

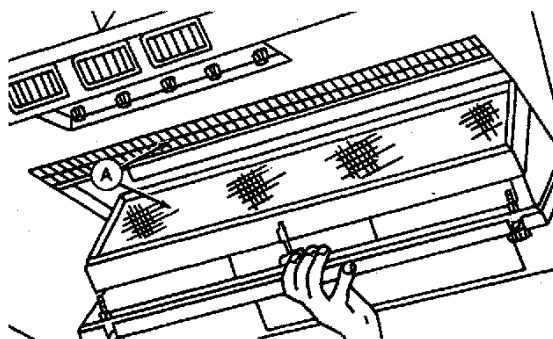

AJ7;RW5704 L U01;HANDLE CHEM 090585

## STAY CLEAR OF ROTATING DRIVELINES

Entanglement in rotating driveline can cause serious injury or death.

Keep tractor master shield and driveline shields in place at all times. Make sure rotating shields turn freely.

Wear close fitting clothing. Stop the engine and be sure PTO driveline is stopped before making adjustments, connections, or cleaning out PTO driven equipment.

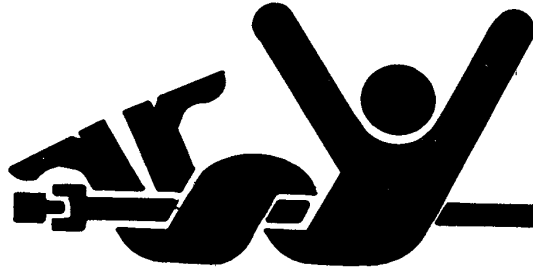

AB6;TS198 053;PTO 160687

## USE A SAFETY CHAIN

A safety chain will help control drawn equipment should it accidentally separate from the drawbar.

Using the appropriate adapter parts, attach the chain to the tractor drawbar support or other specified anchor location. Provide only enough slack in the chain to permit turning.

See your John Deere dealer for a chain with a strength rating equal to or greater than the gross weight of the towed machine. Do not use safety chain for towing.

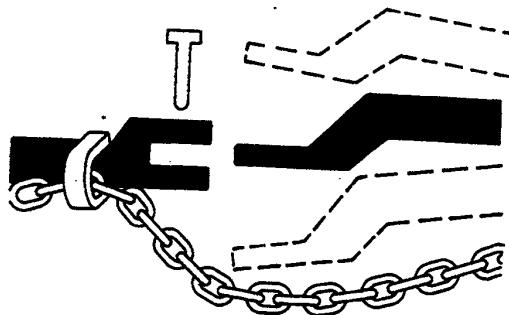

AB6;TS208 053;CHAIN 180987

## TOW EQUIPMENT PROPERLY

Use caution when towing loads at transport speeds. Reduce speed if towed load weighs more than the tractor and is not equipped with brakes. Avoid hard braking applications. (Consult implement operator's manual for recommended transport speeds.)

Use additional caution when transporting towed loads under adverse surface conditions, when turning, or on inclines.

U01;TOW 061284

## SERVICE TRACTOR SAFELY

Do not service the tractor while it is in motion or while the engine is running.

If servicing front-wheel drive equipped tractor with rear wheels supported off ground and rotating wheels by engine power, always support front wheels in a similar manner. If front wheels are not raised, loss of electrical power or transmission-hydraulic system pressure will engage front driving wheels and pull rear wheels off support. Under these conditions, the front-drive wheels can engage even with switch in disengaged position.

Reinstall all shields removed during service.

The air conditioning system is pressurized. Improper servicing may cause refrigerant to penetrate eyes and skin or cause burns. Special equipment and procedures are required to service air conditioning system. (See your John Deere dealer.)

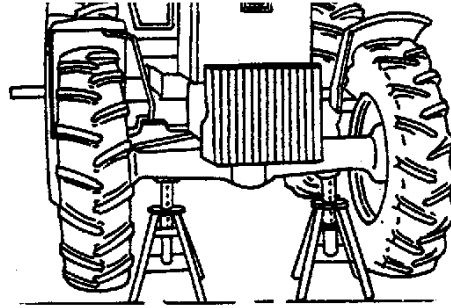

AJ7;RW5700 L U01;WORK SAFE1 090585

## AVOID HIGH-PRESSURE FLUIDS

Escaping fluid under pressure can penetrate the skin causing serious injury. Relieve pressure before disconnecting hydraulic or other lines. Tighten all connections before applying pressure. Keep hands and body away from pinholes and nozzles which eject fluids under high pressure. Use a piece of cardboard to search for leaks.

If ANY fluid is injected into the skin, it must be surgically removed within a few hours by a doctor familiar with this type injury or gangrene may result.

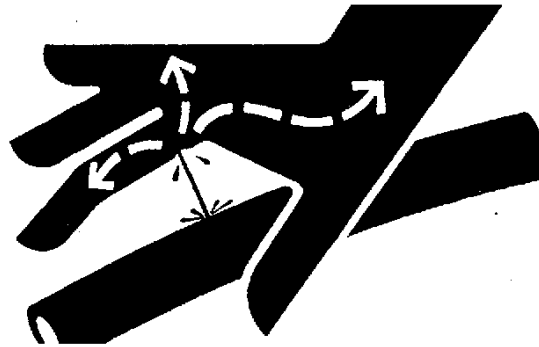

A86;X9811 053;FLUID 180987

### SERVICE COOLING SYSTEM SAFELY

Do not remove radiator cap (A) when engine is hot. Shut the engine off and wait until it cools. Then turn the cap slowly to the first stop to relieve pressure before removing it completely.

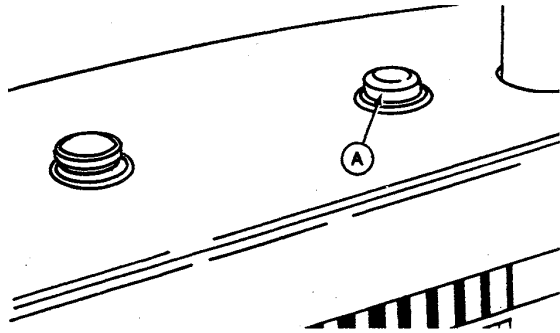

AJ7;RW5702 L U01;COOL IT 090585

### SERVICE BRAKE ACCUMULATOR SAFELY

Accumulator contains gas and oil under pressure. To avoid injury from escaping fluid, relieve all pressure from accumulator before disconnecting brake accumulator or brake valve. To do so open bleed screws and pump brake pedal with engine stopped, until pedal easily goes all the way down.

The accumulator is charged with dry nitrogen to a pressure of 500 psi (3450 kPa) (35 bar). If it needs recharging, have job done only by a qualified service person and only with dry nitrogen.

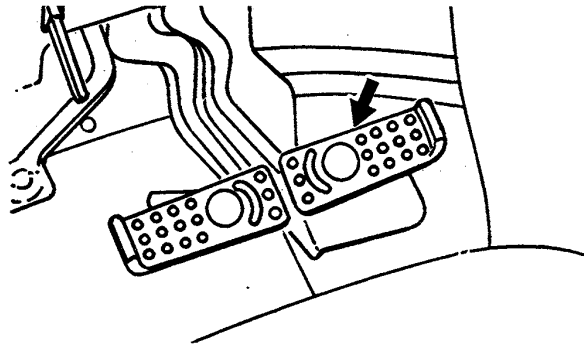

AJ7;RW8630 L U01;FIX BRAKE 311085

### PRACTICE SAFE MAINTENANCE

Understand service procedure before doing work.

Never lubricate or service machine while it is moving. Keep hands, feet, and clothing from power-driven parts. Disengage all power and operate controls to relieve pressure. Lower equipment to the ground. Allow machine to cool.

Securely support any machine elements that must be raised for service work.

Keep all parts in good condition and properly installed. Fix damage immediately. Replace worn or broken parts. Remove any buildup of grease, oil, or debris.

Disconnect battery ground cable (-) before making adjustments on electrical systems or welding on machine.



AB6;TS209 053;SERV 160687

## SERVICE TIRES SAFELY

Failure to follow proper procedures when mounting a tire on a wheel or rim can produce an explosion which may result in serious injury or death. Do not attempt to mount a tire unless you have the proper equipment and experience to perform the job. Have it done by your John Deere dealer or a qualified tire repair service.

When sealing tire beads on rims, never exceed 35 psi (241 kPa) (2.4 bar) or maximum inflation pressures specified by tire manufacturers for mounting tires. Inflation beyond this maximum pressure may break the bead, or even the rim, with dangerous explosive force. If both beads are not seated when the maximum recommended pressure is reached, deflate, reposition tire, relubricate bead and reinflate.

Detailed tire mounting instructions, including necessary safety precautions, are contained in John Deere Fundamentals of Service (FOS) Manual 55, Tires and Tracks, available through your John Deere dealer. Such information is also available from the Rubber Manufacturers Association and from tire manufacturers.

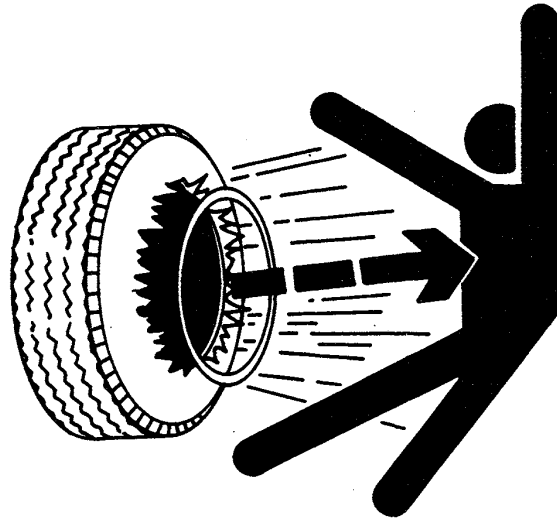

AB6;TS211 U01;TIRE 051087

## KEEP ROPS INSTALLED PROPERLY

Make certain all parts are reinstalled correctly if the roll-over protective structure (ROPS) is loosened or removed for any reason. Tighten mounting bolts to proper torque.

The protection offered by ROPS will be impaired if ROPS is subjected to structural damage, is involved in an overturn incident, or is in any way altered by welding, bending, drilling, or cutting. A damaged ROPS should be replaced, not reused.

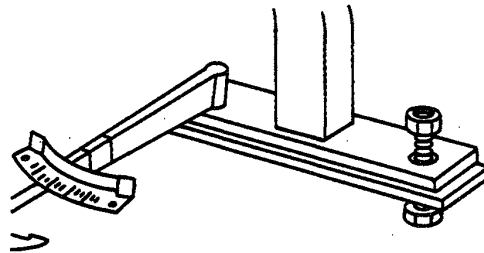

AB6;TS212 053;ROPS3 230487

## TEST COOLANT HEATER IN LIQUID ONLY

Do not plug coolant heater into electrical power unless heating element is immersed in coolant. Sheath could burst and result in personal injury.

Use a heavy-duty grounded cord to connect coolant heater to electrical power.

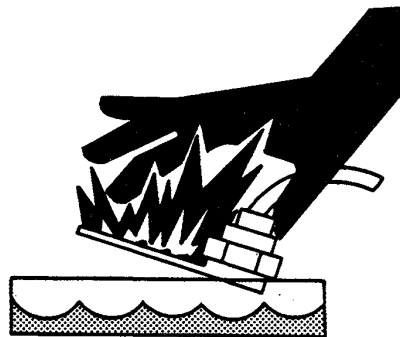

AB6;TS210 U01;HEAT 201087

# Section 220 ENGINE

## CONTENTS

### GROUP 05 - SYSTEM OPERATION

Cooling System .....	220-05-01
Lubrication System .....	220-05-04

### GROUP 10 - SYSTEM TESTS AND DIAGNOSIS

Special Tools .....	220-10-01
Specifications .....	220-10-02
Dynamometer Test .....	220-10-03
Engine Break-In Instructions .....	220-10-04

Diagnosing Engine Malfunctions .....	220-10-05
Compression Gauge Modification .....	240-10-06
Test Engine Compression Pressure .....	220-10-07
Check Valve Lift .....	220-10-08
Check Valve Clearance .....	220-10-08
Check Crankshaft End Play .....	220-10-10
Check Damper Run Out .....	220-10-10
Check Oil Pressure .....	220-10-11
Test Radiator and Cap .....	220-10-12
Test Viscous Fan Drive .....	220-10-13

COOLING SYSTEM - 6466D AND 6466T

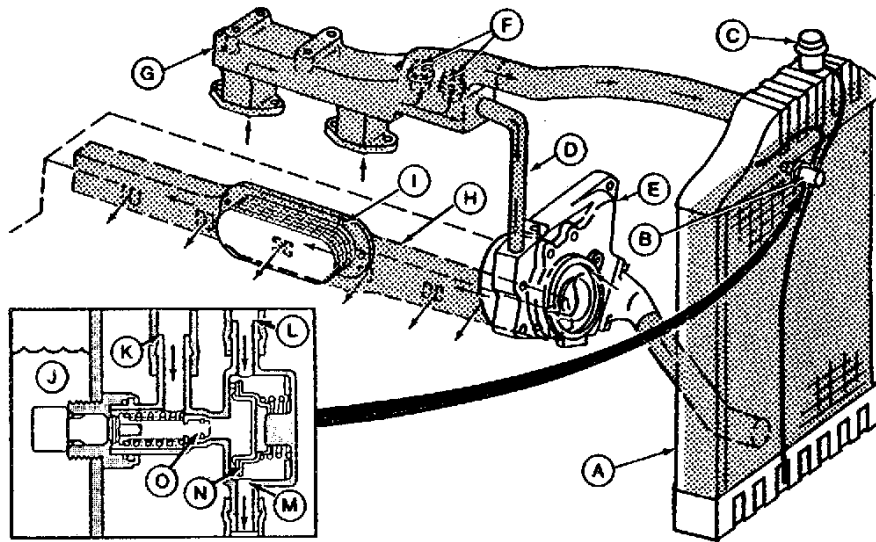

- |                                   |                        |                              |                      |
|-----------------------------------|------------------------|------------------------------|----------------------|
| A—Radiator                        | E—Water Pump           | I—Engine Oil Cooler          | M—Overflow to Ground |
| B—Overflow Valve Housing          | F—Thermostats          | J—Coolant                    | N—Relief Valve       |
| C—Radiator Cap (15 psi; 1.03 bar) | G—Water Manifold       | K—Overflow from Top Tank     | O—Overflow Valve     |
| D—Coolant Bypass Pipe             | H—Main Cooling Gallery | L—Overflow from Radiator Cap |                      |

The dual pressure cooling system consists of a radiator (A), water pump (E), two thermostats (F), and water manifold (G).

A 103 kPa (1.03 bar) (15 psi) pressurizing cap (C) is connected by a hose to a coolant overflow valve (B) mounted at the rear of the radiator. A second hose connects the coolant overflow valve to the radiator top tank. Under normal conditions, relief valve (N) pressurizes the system to 48 kPa (1.48 bar) (7 psi). Under extreme operating conditions (coolant temperatures of 105°C [222°] and above) overflow valve (O) closes, stopping overflow from the radiator top tank (K). The 103 kPa (1.03 bar) (15 psi) cap (C) then pressurizes the system.

**IMPORTANT: Newer model tractors and tractors which have had the overflow valve removed must use a 10 psi cap.**

The pump draws coolant from the bottom of the radiator (A) and discharges it into the main coolant gallery (H) on the left-hand side of the engine. Coolant from the gallery circulates through the block to cool block and cylinder liners, then flows into the cylinder head. From the cylinder head, the coolant passes into the water manifold (G) and thermostat housing.

If the thermostats are closed (as during warm-up periods) coolant is directed back to the pump through the bypass pipe (D) to be recirculated. This provides a faster and more uniform warm-up. If the thermostats are open (engine at normal operating temperature) coolant flows back through the thermostats to the top of the radiator.

The engine oil cooler (I), located in the main gallery, receives its cooling capacities from the coolant flow around it.

AH3;RG4147 20U;220005 AX 240286

**COOLING SYSTEM 6466A**

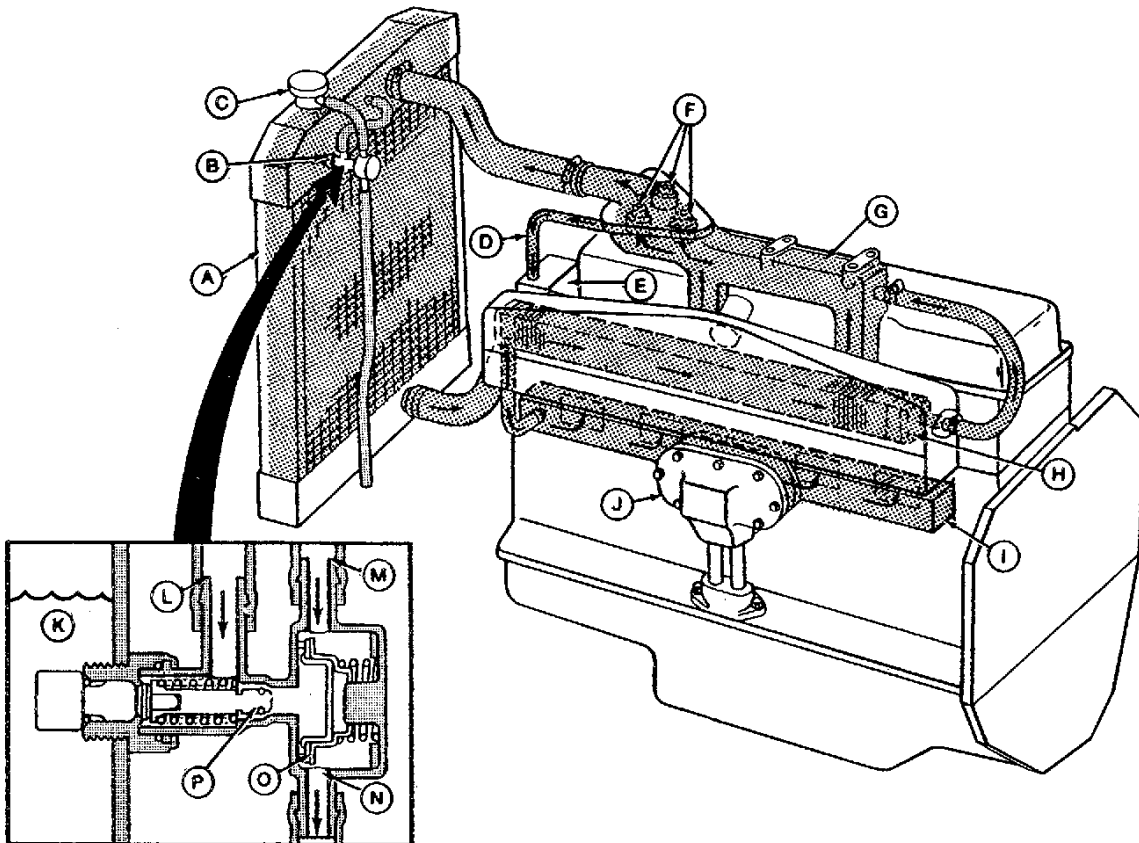

- |  |                       |                        |                              |
|--|-----------------------|------------------------|------------------------------|
| A—Radiator                                   | D—Coolant Bypass Pipe | H—Intercooler          | L—Overflow from Top Tank     |
| B—Overflow Valve Housing                     | E—Water Pump          | I—Main Cooling Gallery | M—Overflow from Radiator Cap |
| C—Radiator Cap 100 kPa<br>(1.0 bar) (15 psi) | F—Thermostats         | J—Engine Oil Cooler    | N—Overflow to Ground         |
|  | G—Water Manifold      | K—Coolant              | O—Relief Valve               |
|  |                       |                        | P—Overflow Valve             |

The dual pressure cooling system consists of a radiator (A), water pump (E), three thermostats (F), and water manifold (G).

A 100 kPa (1.0 bar; 15 psi) pressurizing cap (C) is connected by a hose to a coolant overflow valve (B) mounted at the rear of the radiator. A second hose connects the coolant overflow valve to the radiator top tank. Under normal conditions, relief valve (O) pressurizes the system to 50 kPa (0.50 bar; 7 psi). Under extreme operating conditions (coolant temperatures of 105°C [222°F] and above) overflow valve (P) closes stopping overflow from the radiator top tank (L). The 100 kPa (1.0 bar; 15 psi) cap (C) then pressurizes the system.

The pump draws coolant from the bottom of the radiator (A) and discharges it into the main coolant gallery (I) on the left-hand side of the engine. Coolant from the gallery circulates through the block to cool block and cylinder liners, then flows into the cylinder head. From the cylinder head, the coolant passes into the water manifold (G) and thermostat housing.

If the thermostats are closed (as during warm-up periods) coolant is directed back to the pump through the bypass pipe (D) to be recirculated. This provides a faster and more uniform warm-up.

**IMPORTANT: Newer model tractors and tractors which have had the overflow valve removed must use a 10 psi cap.**

*System Operation*

**COOLING SYSTEM - 6466A (Continued)**

If the thermostats are open (engine at normal operating temperature) coolant flows back through the thermostats to the top of the radiator.

Coolant is also taken from the main gallery into the intercooler (H) to cool intake air. It circulates through the intercooler and out to the water manifold.

The engine oil cooler (J), located in the main gallery, receives its cooling capacities from the coolant flow around it.

A88; S11; 22005 J 100882

## LUBRICATION SYSTEM

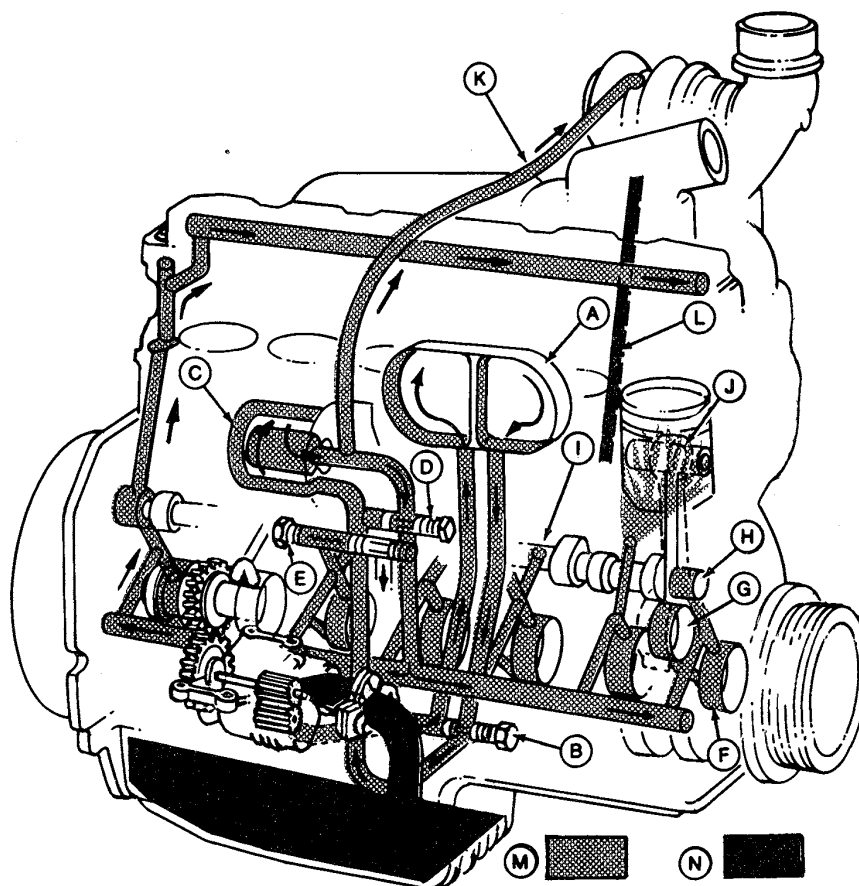

- |                           |                                 |                           |                                |
|---------------------------|---------------------------------|---------------------------|--------------------------------|
| A—Engine Oil Cooler       | E—Oil Pressure Regulating Valve | G—Connecting Rod Bearings | J—Piston Pin and Bushing       |
| B—Oil Cooler Bypass Valve | F—Main Bearings                 | H—Camshaft Bushings       | K—Turbocharger Oil Inlet Line  |
| C—Oil Filter              |                                 | I—Piston Cooling Orifices | L—Turbocharger Oil Return Tube |
| D—Filter Bypass Valve     |                                 |                           | M—Engine Oil Pressure          |
|                           |                                 |                           | N—Oil Pan Oil                  |

The engine lubrication system consists of a gear-driven positive displacement pump, oil cooler, oil filter, cooler bypass valves, oil pressure regulating valve and filter bypass valve.

Oil is pumped from the oil pan by the engine oil pump through the engine oil cooler (A) around the oil cooler bypass valve (B) into the engine oil filter (C). On turbocharged engines oil is directed to the top of the oil filter housing through the oil inlet line (K) to lubricate the turbocharger. Oil is then returned through the turbocharger oil return tube (L) and back to the oil pan as non-pressured oil. Passing through the filter, the oil continues around the filter bypass valve (D) and in front of the engine oil pressure

regulating valve (E) into the engine oil gallery in the cylinder block. Oil is then distributed, under pressure, to each main bearing (F) and piston cooling orifice (I). Oil from the piston cooling orifices lubricates the piston pin and bushing (J) through a hole in the connecting rod.

Cross-drilled passages in the crankshaft distribute oil from the main bearing journals to the connecting rod journals to lubricate connecting rod bearings (G). Numbers 1, 3, 5, and 7 main bearing supports are also drilled to lubricate the four camshaft bushings (H). A drilled passage from the rear camshaft bushing through the cylinder block and cylinder head provides lubrication to the rocker arm shaft.

**Group 10**  
**SYSTEM TESTS AND DIAGNOSIS**

**SPECIAL TOOLS**

*NOTE: Order special tools from your SERVICE-GARD catalog unless otherwise indicated.*

<b>Number</b>	<b>Name</b>	<b>Use</b>
0070 (D1)	Fitting	Test Oil Pressure
2106 (D19-HP)	Hose and Fitting Assembly	Test Oil Pressure
2026 (D20)	Gauge	Test Oil Pressure
D-14547BA	Motorite Tester	Test Engine Compression
D-14557BA	Adapter	Test Engine Compression
JDE 81-1	Flywheel Turning Tool	Rotate Flywheel
JDE 81-4	Timing Pin	Locate TDC
JDE-92	Socket Wrench	Remove Injection Nozzles
Fabricated	Cardboard Air Restrictor	Test Viscous Fan
Fabricated	Harness	Test Viscous Fan
Fabricated	Bracket	Test Viscous Fan
RE12181 (John Deere Service Parts)	Ground Speed Sensor	Test Viscous Fan

20U;220010 AE 060386

**SPECIFICATIONS**

Item	Specification
<b>Compression Pressure</b>	
6466D-4050.....	3000-3410 kPa (30-34.1 bar) (435-495 psi)
6466T-4250.....	2690-3100 kPa (26.9-31 bar) (390-450 psi)
6466T-4450, 6466A-4650 and 6466A-4850.....	2450-2860 kPa (24.5-28.6 bar) (355-415 psi)
<b>Valve Clearance</b>	
Intake .....	0.41-0.51 mm (0.016-0.020 in.)
Exhaust .....	0.66-0.76 mm (0.026-0.030 in.)
<b>Valve Lift</b>	
6466D-4050	
Intake .....	10.77-11.53 mm (0.424-0.454 in.)
Exhaust.....	10.52-11.28 mm (0.414-0.444 in.)
6466T-4250, 4450 and 6466A-4650, 4850	
Intake .....	10.5-11.2 mm (0.412-0.442 in.)
Exhaust.....	10.5-11.3 mm (0.412-0.443 in.)
Crankshaft End Play .....	0.0380-0.380 mm (0.00150-0.0150 in.)
Maximum Serviceable .....	0.380 mm (0.0150 in.)
Damper Run Out (max.) .....	1 mm (0.040 in.)
Oil Pressure.....	280-400 kPa (2.8-4.0 bar) (41-58 psi)

A87; S11;22010 AO 070683

## DYNAMOMETER TEST

If possible, test the engine on a dynamometer before it is tuned. This test gives the horsepower output and fuel consumption of the engine as it is. This will help determine if a tune-up can restore the engine or whether an overhaul is needed.

Good performance by the engine depends on these basic things.

1. An adequate supply of clean air and fuel.
2. Good compression.
3. Proper valve and injection pump timing for good combustion.
4. Proper air and fuel temperatures.

Make the dynamometer test as follows:

1. Connect the engine to the dynamometer using the manufacturers' instructions.
2. Operate the engine at one-half load until the coolant and crankcase oil temperature are up to normal.
3. Run engine at fast idle (2375 rpm).
4. Gradually increase the load on the engine until its speed is reduced to full load rpm.
5. Read the horsepower on the dynamometer.
6. Compare the reading taken with the following chart.

Tractor	Engine Speeds (rpm)			Factory Test
	Slow Idle	Fast Idle	Full Load	PTO @ 2200 - Engine
				kW (Horsepower)
4050	850	2375	2200	75 (100)
4250	850	2375	2200	89 (120)
4450	850	2375	2200	104 (140)
4650	850	2375	2200	123 (165)
4850	850	2375	2200	142 (190)

A87; S11;22010 AE 301183

## ENGINE BREAK-IN INSTRUCTIONS

Use a dynamometer to perform the following break-in procedure. If necessary, engine break-in can be performed without a dynamometer if under controlled operating conditions.

Fill engine crankcase with TORQ-GARD SUPREME™ 10W-20 oil to proper level for use during the break-in operation.

TIME	LOAD	ENGINE SPEED	REMARKS
5 Minutes	No Load	850 rpm	Check oil pressure, coolant, temperature, and leakage.
5 Minutes	No Load	1500 to 2000 rpm	
5 Minutes	1/4 Load	1900 to 2100 rpm	
10 Minutes	1/2 Load	1900 to 2100 rpm	
10 Minutes	1/2 to 3/4 Load	1900 to 2100 rpm	
10 Minutes	3/4 to Full Load	2200 rpm	

After break-in, run engine one to two minutes at 1500 rpm, No Load before shut-down. Loosen, then retighten F-Grade cylinder head cap screws as specified in Section 20, Cylinder Head, Valves, and Camshaft in either John Deere Technical Manuals TM-1257 or TM-1258. Loosen, then retighten rocker arm shaft clamps to specified torque. Check and readjust valve clearance as necessary. No retorque is required for engine equipped with G-Grade cylinder head cap screws.

During the first 100 hours of operation, avoid over-loads, excessive idling, and no-load operation. Do NOT use foot throttle. After 100 hours, drain crankcase oil and change oil filter. Fill crankcase with oil of proper viscosity and service classification.

AB7; S11;22010 AF 250794

## DIAGNOSING ENGINE MALFUNCTIONS

### WILL NOT START

- Fuel System Malfunction - See Section 230
  - Empty fuel tank
  - Fuel shut off cable not pushed in
  - Improper fuel
  - Plugged fuel filter
  - Fuel shut off at tank
- Electrical System Malfunction - See Section 240
  - Corroded or loose battery connections
  - Weak battery

### ENGINE RUNS IRREGULARLY OR MISSES

- Basic Engine Problem - See Section 20
  - Improper valve clearance
  - Low compression
  - Engine overheating
  - Valves sticking or burned
  - Worn camshaft lobes
  - Detonation
- Fuel System Malfunction - See Section 230
  - Low fuel supply
  - Restricted fuel line or filter
  - Air in fuel
  - Incorrect injection pump timing
  - Plugged or defective injection nozzle
  - Faulty injection pump
  - Faulty fuel pump
  - Improper fuel

### FREQUENT STALLING

- Operator Error
  - Engine not at operating temperature
- Fuel System Malfunction - See Section 230
  - Restricted fuel lines
  - Faulty fuel pump
  - Plugged fuel filter
  - Vent on fuel tank cap obstructed
  - Dirty or faulty injectors

### LACK OF POWER

- Basic Engine Problem - See Section 20
  - Low compression
  - Engine overheating
  - Incorrect valve clearance
  - Blown cylinder head gasket
  - Worn camshaft lobes
  - Burned, warped, pitted or sticking valves
  - Weak valve springs
- Service Problem
  - Dirty or obstructed air cleaners
  - Improper fuel

- Fuel System Malfunction - See Section 230
  - Plugged fuel filters
  - Faulty injection nozzles
  - Restricted exhaust system
  - Plugged fuel tank vent
- Power Train Malfunction - See Section 250
  - Clutch Slipping

### ENGINE OVERHEATS

- Basic Engine Problem - See Section 20
  - Loosen or broken fan belt
  - Faulty thermostats
  - Defective radiator pressure cap
  - Faulty water pump
- Service Problem - See Section 10
  - Low coolant level
  - Crankcase oil level low
  - Engine overloaded
  - Improper fuel
- Fuel System Malfunction - See Section 230
  - Excessive fuel delivery
  - Improper injection pump timing

### EXCESSIVE OIL CONSUMPTION

- Basic Engine Problem - See Section 20
  - Worn valve guides or valve stems
  - Oil control rings worn or broken
  - Worn or scored liners or pistons
  - Piston ring gaps not staggered
  - Excessive main or connecting rod bearing clearance
- Service Problem - See Section 10
  - Engine oil too thin
  - Oil level too high

### LOW OIL PRESSURE

- Basic Engine Problem - See Section 20
  - Stuck or improper regulating valve adjustment
  - Excessive main and connecting rod bearing clearance
  - Plugged oil pump intake screen
  - Leakage at internal oil passages
  - Faulty oil pump
- Service Problem - See Section 10
  - Low oil Level
  - Improper viscosity of oil
  - Faulty gauge

### HIGH OIL PRESSURE

- Basic Engine Problem - See Section 20
  - Stuck or improperly adjusted regulating valve

A87; 511;22010 AP 100882

## DIAGNOSING ENGINE MALFUNCTIONS - Continued

### EXCESSIVE FUEL CONSUMPTION

- Basic Engine Problem - See Section 20
- Low compression
- Fuel System Malfunction - See Section 230
  - Leaks in fuel system
  - Restricted air cleaners
  - Faulty injection pump timing
  - Improper valve clearance
- Service problem - See Section 10
- Improper grade of fuel
- Fuel System Malfunction - See Section 230
  - Excessive fuel delivery
  - Faulty injection nozzles
  - Restricted air cleaners
  - Improper injection pump timing

### WHITE EXHAUST SMOKE

- Basic Engine Problem - See Section 20
- Low compression
- Fuel System Malfunction - See Section 230
  - Faulty injection nozzles
  - Improper fuel

### SLOW ACCELERATION

- Fuel System Malfunction - See Section 230
  - Faulty injection pump
  - Faulty injection nozzles

### DETONATION

- Fuel System Malfunction - See Section 20
  - Faulty injection pump
  - Faulty injection nozzles
  - Improper fuel

### ABNORMAL ENGINE NOISE

- Basic Engine Problem - See Section 20
- Low engine oil level
- Excessive valve clearance
- Worn cam followers
- Bent push rods
- Worn rocker arm shafts
- Worn main or connecting rod bearings
- Foreign material in combustion chamber
- Worn Piston pin bushings and pins
- Scored piston
- Incorrect engine timing
- Excessive crankshaft end play
- Loosen main or connecting rod bearing caps
- Crankshaft oil pump drive gear worn or broken
- Crankshaft vibration damper worn or separated

A87;S11;22010 AQ 080884

## COMPRESSION GAUGE MODIFICATION

The hose to adapter end of the D-14547BA Motorite Tester is equipped with a brass dampening disk (A) originally designed for checking compression at slow idle. This disk interferes with a cranking compression check requiring 25 to 30 compression strokes to obtain peak compression pressure.

Remove check valve seat (B), spring and disk (A) from adapter end of hose. Drill a 1/16 in. hole (C) in disk and reassemble. Peak pressure can now be obtained in 6 to 7 compression strokes.

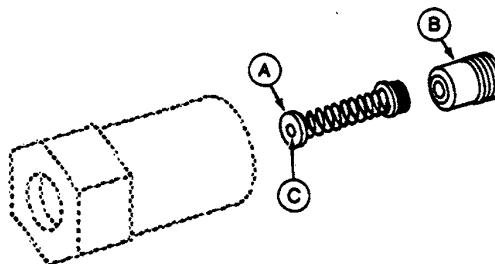

A87;RW1262 5 20U;22010 XX2 151087

## TEST ENGINE COMPRESSION PRESSURE

**NOTE:** Before beginning test, insure that batteries are fully charged and injection nozzle area is thoroughly cleaned.

1. Remove injection lines, leak-off lines, and injection nozzles. (See Remove Injection Nozzles in Section 30).
2. Install the D-14557BA adapter (A) with the D-14547BA Motorite Tester (B) and hose into injection nozzle bore.
3. Pull out engine shut-off knob.
4. Close fuel shut-off valve.
5. Crank engine over and record readings.

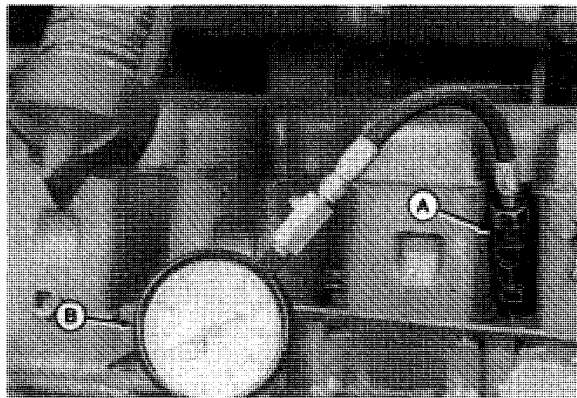

### ENGINE COMPRESSION

Tractor	Cranking Speed	Compression Pressure*
4050	200-250 rpm	3000-3410 kPa (30-34.1 bar) (435-495 psi)
4250, 4450 and 4650	200-250 rpm (390-450 psi)	2690-3100 kPa (26.9-31 bar)
4850	200-250 rpm	2450-2860 kPa (24.5-28.6 bar) (355-415 psi)

Pressure given was taken at 1000 feet above sea level. A 3.6 percent reduction in gauge pressure will result for each additional 1000 feet of altitude.

6. If pressure is much lower than shown, remove gauge and apply oil to ring area of piston through injection nozzle bore. Do not use too much oil. Do not get oil on the valves.

A87;RG4118 20U;22010 AG 151087

7. Test compression again. If pressure is high, worn or stuck rings are indicated. If pressure is still low, it is possible that valves are worn or sticking.

8. Compare readings from all cylinders.

**NOTE:** All cylinder pressures should be approximately alike. There should be less than (340 kPa) (3.4 bar) 50 psi difference between cylinder pressures.

A87; S11;22010 U 041281

## CHECK VALVE LIFT

Measuring valve lift can give an indication of wear on cam lobes or cam followers

1. Adjust valve clearance to previous specifications.
2. Place dial indicator on valve rotator. Be sure that valve is fully closed and the rocker arm moves freely.
3. Zero dial indicator.
4. Manually turn engine in running direction, using the engine rotation tools previously mentioned.
5. After rocker arm contacts valve wear cap, observe dial indicator reading as valve is moved to fully open position.

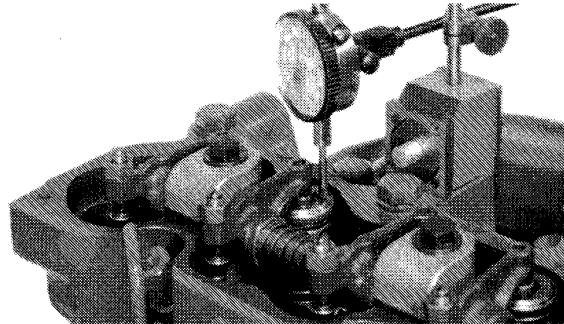

### VALVE LIFT SPECIFICATIONS

	Engines Intake Valves	Exhaust Valves
6466D	10.77 - 11.53 mm (0.424 - 0.454 in.)	10.52 - 11.28 mm (0.414 - 0.444 in.)
All Other Engine Models	10.5 - 11.2 mm (0.412 - 0.442 in.)	10.5 - 11.3 mm (0.412 - 0.443 in.)

A87;RG4121 S11;22010 AH 100882

## CHECK VALVE CLEARANCE

1. Remove rocker arm cover.
2. Remove vent tube (shown removed) and plastic plugs (A).
3. Install JDE-81-1 Flywheel Rotation Tool (A) and JDE-81-4 Timing Pin (B).
4. Turn flywheel until timing pin engages timing pin hole in flywheel at No.1 TDC. Both valves on No.1 cylinder should be in the up position. (Rocker arms loose.)

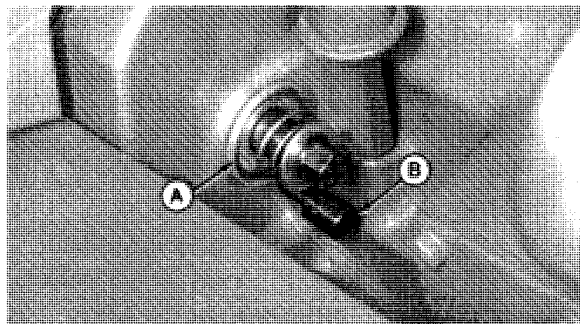
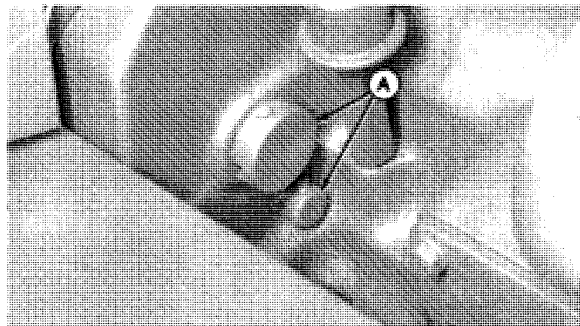

A87;RG4119, RG4120 S11;22010 AI 100882

## System Tests and Diagnosis

5. Adjust valve clearance on No. 1, 3, and 5 exhaust valves and No. 1, 2, and 4 intake valves.

6. Rotate flywheel 360 degrees until No. 6 piston is at "TDC" of its compression stroke, and tool timing pin engages flywheel hole.

7. Adjust valve clearance on No. 2, 4, and 6 exhaust valves and No. 3, 5, and 6 intake valves.

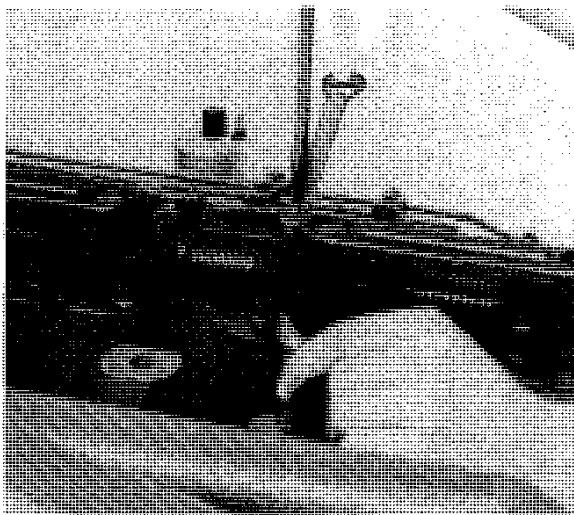

### VALVE CLEARANCE SPECIFICATIONS

Engine	Intake	Exhaust
6466	0.41-0.51 mm (0.016-0.020 in.)	0.66-0.76 mm (0.026-0.030 in.)

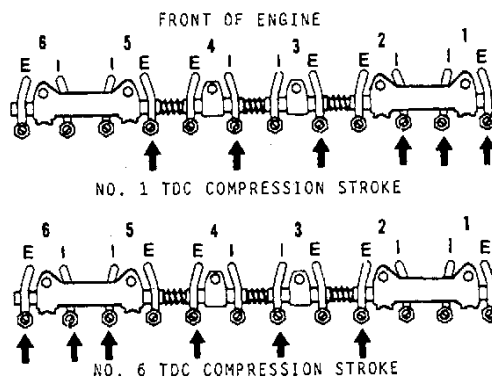

A87:RG7813 9H1, RG4295 S11:22010 AJ 070683

### CHECK CRANKSHAFT END PLAY

1. Completely depress and release the clutch pedal.
2. Remove cap screws (A) on hydraulic pump shaft (B).
3. Remove coupler assembly (C).
4. Remove vent tube and timing pin plastic plug (shown removed).
5. Place dial indicator (A) tip through timing pin hole (B) and against flywheel. Zero the indicator.

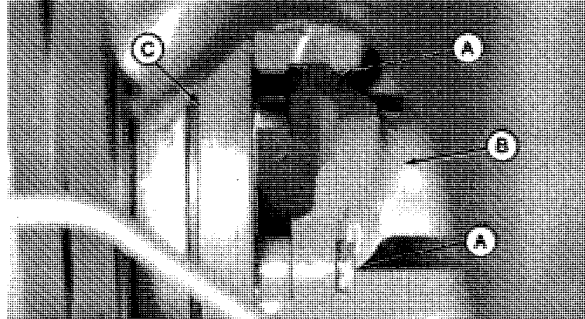

**IMPORTANT: Use care not to damage or distort the timing gear cover, damper pulley, bearing inserts, or hydraulic shaft when prying. DO NOT pry on rubber damper at rear of pulley.**

6. Gently pry with flat bar between pulley hub and timing gear cover. Record reading. Gently pry crankshaft rearward and repeat check.

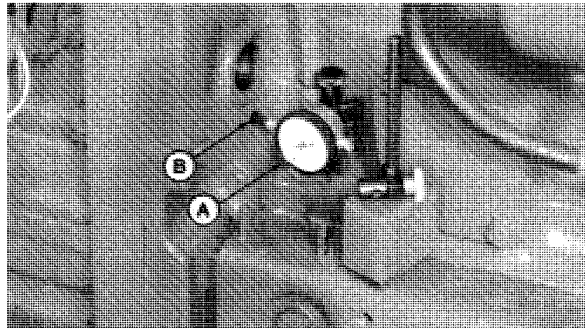

### CRANKSHAFT END PLAY SPECIFICATIONS

All models . . . . .0.0380-0.380 mm (0.00150-0.015 in.)  
Maximum serviceable . . . . .0.380 mm (0.0150 in.)

7. Install timing pin plastic plug and vent tube.
8. Install coupler assembly and hydraulic shaft torque shaft cap screws to 47 N·m (35 lb-ft).

A87;RG4122 RG4174 S11;22010 AK 100882

### CHECK DAMPER RUN OUT

*NOTE: Engine should be run approximately five minutes before checking damper run out.*

1. Thoroughly clean outer edge of damper pulley.
2. Attach dial indicator so tip rests on damper edge (A).
3. Use JDE-8-1 Flywheel Rotation Tool to rotate pulley. If run out of damper exceeds 1 mm (0.040 in.) replace damper.

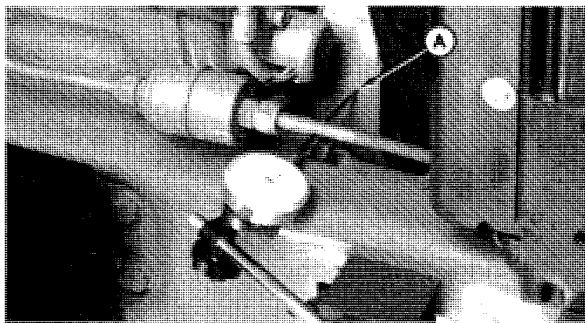

A87;RG4123 S11;22010 AL 100882

## CHECK OIL PRESSURE

1. Remove pipe plug (a) from main oil gallery.

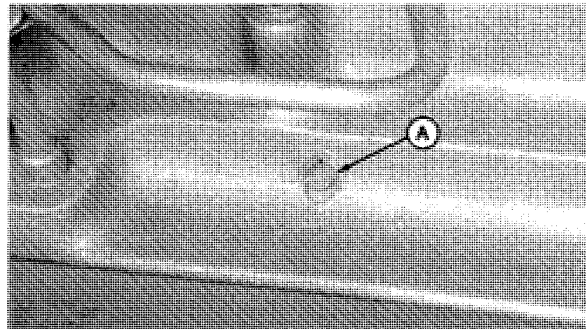

A87;RG4124 S11;22010 AM 050882

2. Install No. 0070 (D1) Fitting (A), No. 2106 (19-HP) Hose (B), and No. 2026 (D-20) Gauge (C).
3. Warm up engine and run at 1900 rpm.
4. Oil pressure should be 280-380 kPa (2.8-3.8 bar) (40-55 psi).

*NOTE: To adjust oil pressure remove regulating valve spring at filter base and add washers to increase oil pressure. Subtract washers to decrease oil pressure.*

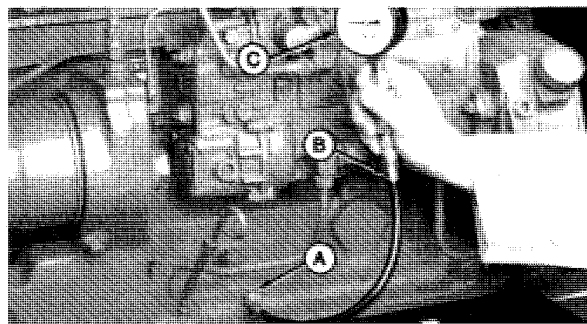

*NOTE: Do not use more than a total of five washers.*

A87;RG4125 S11;22010 AN 310583

### **TEST RADIATOR AND CAP**

1. Open hood and remove radiator cap.
2. Visually check radiator for leaks or damage.
3. Disconnect hose (A) from overflow valve (B).
4. Plug hose as shown using a cap screw and hose clamp.
5. Attach D-05104ST radiator tester (C) to filler neck. Pressurize to 120 kPa (1.2 bar) (18 psi).
6. Repair system as necessary if pressure does not hold.

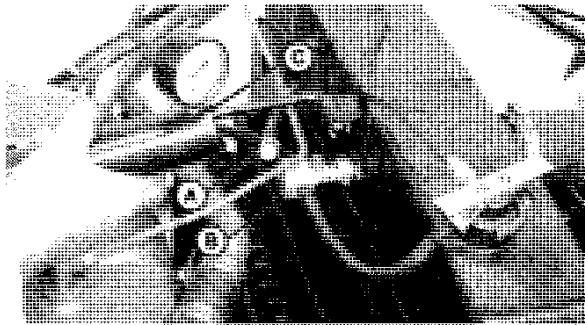

A87;RG4126 S11;22010 AR 050882

7. Install radiator cap onto D-05104ST tester as shown.
8. Pressurize to 100-120 kPa (1.0-1.2 bar) (14-17 psi). Replace cap if it does not hold pressure.

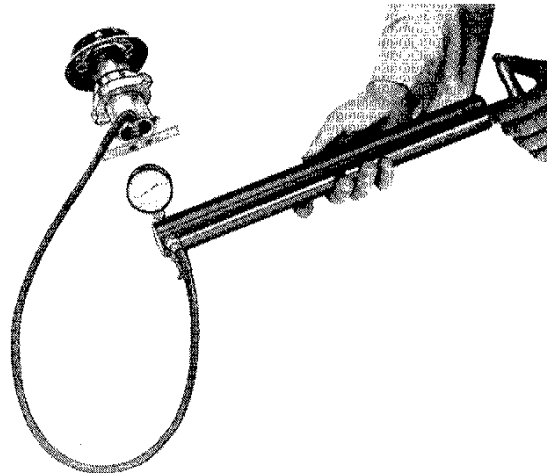

A87;R26406N S11;22010 BH 050882

## TEST VISCOUS FAN DRIVE

① Perform the following preliminary checks with engine OFF. Correct any abnormal conditions before proceeding.

1. Side screens, oil cooler and radiator cooling fins **must be free** of dirt and debris.

*NOTE: Any dirt found in front of radiator is a strong indication that radiator fins are plugged.*

2. All baffles and foam seals present and properly positioned.
3. Radiator core internally free of sludge or sediment.
4. Coolant at correct level. (Coolant loss may be caused by faulty radiator cap or overflow valve.)
5. Fan resists hand rotation, but does not lock up. When fan drive is at operating temperature, it should rotate no more than one-half revolution.
6. No more than 6 mm (1/4 in.) linear movement of fan drive. (Apply slight push and pull at tip of fan blade.)
7. Area at rear of fan assembly dry-to-damp area accumulating dust.
8. Fan belts properly adjusted.
9. Perform high pressure to sump and return leakage checks. (See Section 70, Group 60 or Group 65.)

② Check operation of thermostat. Correct any abnormal conditions before proceeding.

1. Install two jumper hoses in two SCV's and set metering valve at 12 o'clock position.
2. Slowly remove radiator cap and install a thermostat in top tank.
3. Run engine at 1700—1800 rpm.
4. Move SCV levers to circulate hydraulic oil.

*NOTE: If ambient temperature is below 40°F, cover side screens with cardboard.*

## System Tests and Diagnosis

5. After top tank has reached peak temperature, 170—180°F, compare temperature gauge needle position and top tank thermometer reading with chart below.
6. If gauge needle position and top tank temperature correspond to chart, thermostat is normal; proceed to **warm** viscous fan drive operational check at step 3.
7. If temperature gauge needle indicates coolant is much hotter than radiator top tank, check temperature sensor resistance and compare with chart. Check calibration of temperature gauge with JTO 1633 Gauge Checker. If both are normal, thermostat is “stuck” closed and must be replaced. Proceed to step 3.
8. If temperature gauge needle is very slow to rise or below green band and top tank temperature is above 160°F, check temperature sensor resistance and compare with chart. Check calibration of temperature gauge with JTO 1633 Gauge Checker. Make repairs before proceeding to step 3.
9. If coolant is circulating in top tank of radiator, but temperature gauge and test gauge indicate coolant is below 160°F, thermostat is “stuck” open and must be replaced. Proceed to step 3.

*NOTE: Replace radiator cap before proceeding.*

20U;220010 BX2 240286

### GAUGE CLUSTER SYSTEM

Sensor		Temperature Gauge	
Temperature	Resistance	Approximate Temperature	Ohms
38°C (100°F)	310—390	1. 71°C (160°F)	130—150
49 (120)	225—275	2. 83 (180°F)	100—115
60 (140)	170—200	3. 94 (200°F)	80—90
72 (160)	130—150	4. 99 (210°F)	70—80
83 (180)	100—115	5. 110 (230°F)	----
88 (190)	90—100	6. 116 (240°F)	45—55
94 (200)	80—90		
99 (210)	70—80		
105 (220)	60—70		
110 (230)	50—60		
116 (240)	45—55		

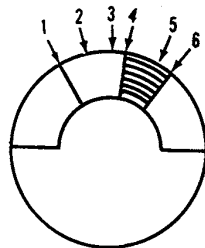

TEMPERATURE GAUGE  
(GAUGE CLUSTER)

### SMU SYSTEM

Sensor		Temperature Gauge	
Temperature	Resistance	Approximate Temperature	OHMS
40°C (104°F)	1075—1093	1. 71°C (160°F)	1200—1310
50 (122)	1132—1150	2. 83 (180°F)	1300—1400
60 (140)	1190—1210	3. 94 (200°F)	1385—1470
70 (158)	1250—1270	4. 99 (210°F)	1400—1480
80 (176)	1311—1331	5. 110 (230°F)	1480—1550
90 (194)	1374—1394	6. 116 (240°F)	1515—1585
100 (212)	1437—1459		
110 (230)	1503—1525		
120 (248)	1570—1592		

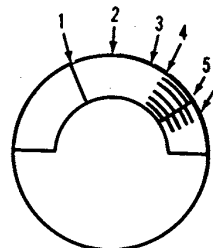

TEMPERATURE GAUGE  
(SMU SYSTEM)

AH3;RW1173 8L,RW1173 7L 20U;220010 BX 200286

## System Tests and Diagnosis

### 3 Perform **WARM** viscous fan drive operational check.

1. Attach RE12181 ground speed sensor (A) to injection pump front cover using fabricated bracket (B) and hose clamp (C). On 4050 Tractors Serial No. (6510- ) mount sensor and bracket on left fan guard mounting bracket (E). (See Section 299 for bracket fabrication.)
2. Rotate fan blade and adjust air gap (D) between sensor and closest fan blade to 3 mm (1/8 in.).

A—Ground Speed Sensor  
B—Fabricated Bracket  
C—Hose Clamp  
D—Air Gap  
E—Fan Guard Mounting Bracket

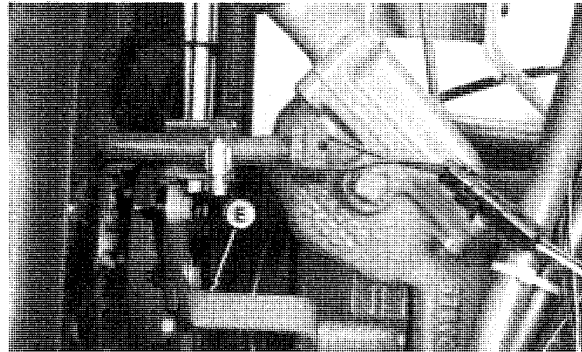
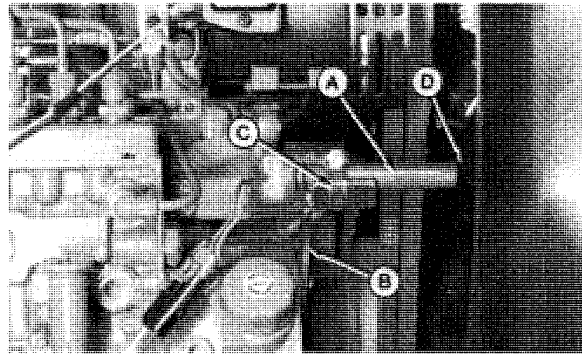

AH3;RW1182 8,RW1174 7 20U;220010 CX 240286

3. Connect fabricated harness (A) to fan sensor (B). (See Section 299 for harness fabrication.)
4. Connect engine speed sensor (C) and engine harness lead (D) to fabricated harness (A).
5. Operate engine and circulate oil thru SCV's until coolant temperature reaches 165—180°. (Left-hand 1/3 of green band on gauge.)

**NOTE:** If cardboard has been used to heat oil, it must be removed before making fan speed check to prevent fan overspeed.

A—Fabricated Harness  
B—Fan Sensor  
C—Engine Speed Sensor  
D—Engine Harness Lead

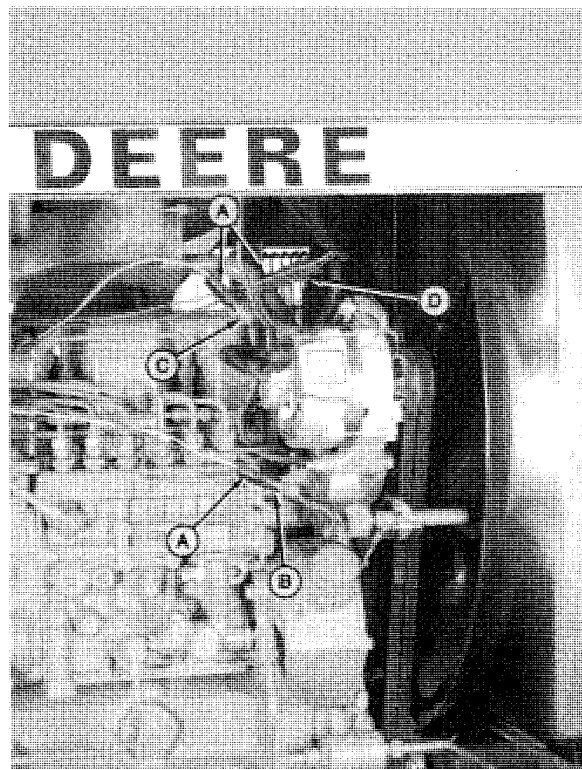

AH3;RW1182 9 20U;220010 DX 240286

## System Tests and Diagnosis

6. Flip special harness switch to engine speed sensor. Observe tractor tachometer and adjust engine speed to 2200 rpm.
7. Flip harness switch to fan speed sensor. Observe tachometer and record fan rpm reading.

*NOTE: Fan speed may vary 150 rpm within specified range during testing.*

8. Compare fan rpm reading with following chart.

### TACHOMETER READINGS

Model	Engine Sensor RPM	Fan Sensor RPM*	Actual Fan RPM
4050-4250-4450	2200	640—1200 x 1.25 =	800—1500
4650-4850	2200	560—1080 x 1.25 =	700—1350

*\*Fan rpm reading must be multiplied by 1.25 to get actual fan speed.*

20U;220010 EX 190286

#### ④ Results of **WARM** fan drive check:

1. If fan speed is within specified range, proceed to step 5 and perform **hot** fan drive operational check.
2. If fan speed is below spec, replace fan drive.
3. If fan speed is above spec and tractor is equipped with **ANALOG** tachometer, reverse polarity of leads at fan sensor, repeat test. If fan speed is still above spec, replace fan drive.
4. If fan speed is above spec and tractor is equipped with **DIGITAL** tachometer, replace fan drive.

20U;220010 FX 200286

## System Tests and Diagnosis

### 5 Perform **HOT** viscous fan drive operational check.

1. With engine at 800—1000 rpm, cover front side of radiator with three sections of cardboard. Upper section must be tight against top tank. Large hole in center cardboard section must be aligned with fan drive sensor. (Refer to Section 299 for construction of cardboard.)

*NOTE: The specified hole size must be used to provide correct air flow to the fan drive sensor and fan blades.*

2. Operate engine at 2200 rpm, move SCV levers to circulate hydraulic oil.

**IMPORTANT: DO NOT operate air conditioning system.**

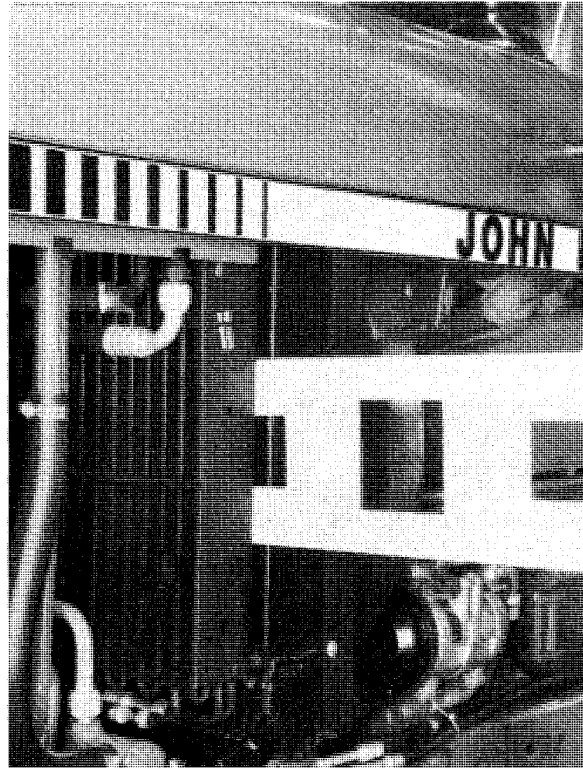

AH3;RW1183 0 20U;220010 GX 190286

3. Temporarily cover three square holes in cardboard covering radiator to raise engine cooling system to 110°C (230°F). (Reference temperature chart in step 2.)

*NOTE: If ambient temperature is below 24°C (75°F), load engine on dynamometer (25—50 hp) to raise coolant temperature.*

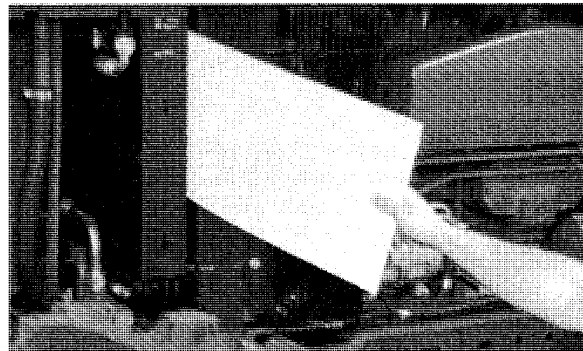

AH3;RW1183 1 20U;220010 HX 190286

## System Tests and Diagnosis

- When center of temperature gauge needle is exactly at the 100°C (230°F) check point, move SCV levers to neutral and remove cover from three square holes in cardboard covering radiator.
- Allow temperature to stabilize at 110°C (230°F) for 2—5 minutes with engine at 2200 rpm.
- Record fan speed and compare to chart.

### TACHOMETER READINGS

Model	Engine Sensor RPM	Fan Sensor RPM*	Actual Fan RPM
4050-4250-4450	2200	1760—1920 x 1.25 =	2200—2400
4650-4850	2200	1600—1740 x 1.25 =	2000—2175

\*Fan rpm reading must be multiplied by 1.25 to get actual fan speed.

20U;220010 IX 151087

- If fan speed is **IN SPEC**, reduce engine speed to 1800 rpm and uncover radiator to allow engine to cool.
- If fan speed is **OUT OF SPEC**, remove only the center cardboard (with holes) and allow engine to cool until gauge needle is at least 3 mm (1/8 in.) into green band. Repeat **HOT** test steps 2—6.

*NOTE: Some fan drives have a "fluid lag" that requires a heat soaking period to provide proper drive engagement. Heat soaking will occur during the second heating cycle.*

20U;220010 JX 240386

## System Tests and Diagnosis

### 6 Results of **HOT** fan drive test:

1. If fan speed was out of spec after repeating HOT operational check, replace fan drive. Clean radiator when fan is out.
2. If fan speed was in spec at first or second speed check, but engine has been overheating, check the following areas for cause of overheating.
  - a. High pressure to sump or return leakage in hydraulic system.
  - b. Restricted air flow through oil cooler.
  - c. Restricted air flow through radiator. (Move oil cooler to side to inspect.)
  - d. High compressor discharge pressure (restricted air flow through condensor.)
  - e. Engine cooling system thermostat stuck open.
  - f. Continuous loss of coolant due to radiator cap relieving at too low pressure or head gasket or cylinder liner leaking combustion pressure into cooling system.
  - g. Radiator core restricted internally by sludge or sediment.
  - h. Inadequate circulation of coolant by water pump.

20U;220010 KX 200286



**Suggest:**

**If the above button click is invalid.**

**Please download this document**

**first, and then click the above link**

**to download the complete manual.**

**Thank you so much for reading**

# Section 230 FUEL/AIR

## CONTENTS

### GROUP 05 - AIR INTAKE SYSTEM

Special Tools .....	230-05-01
Specifications .....	230-05-01
How the Air Intake System Works .....	230-05-02
Diagnosing System Malfunctions .....	230-05-03
How the Turbocharger Works .....	230-05-04
Check Intake Manifold Pressure .....	230-05-05
Check Intake Manifold Pressure From Ether Starting Aid Line (Injection Pump Side) .....	230-05-06

### GROUP 10 - DIESEL FUEL SYSTEM

Special Tools .....	230-10-01
Specifications .....	230-10-01
Fuel System .....	230-10-02
Diagnose Fuel System Malfunctions .....	230-10-03
How the Supply Pump Works .....	230-10-07
Inspect Fuel Pump Valves .....	230-10-09
How the Fuel Filter Works .....	230-10-09
Bleed the Fuel System .....	230-10-10
How the (In-Line Type) Fuel Injection Pump Works .....	230-10-11

Diagnosing (In-Line Type) Injection Pump Malfunctions .....	230-10-12
Check and Adjust Pump Timing .....	230-10-13
Check and Adjust Fast Idle Speed .....	230-10-14
Check and Adjust Slow Idle Speed .....	230-10-16
How the Aneroid Works .....	230-10-18
Diagnosing Aneroid Malfunctions .....	230-10-19
How the Hydraulic Aneroid Activator Works .....	230-10-20
Hydraulic Aneroid Activator Diagnosing Malfunctions Chart .....	230-10-21
Fuel Injection Nozzles General Information .....	230-10-21
How the Fuel Injection Nozzle Works ...	230-10-23
Diagnosing Fuel Injection Nozzle Malfunctions .....	230-10-24

### GROUP 15 - CONTROL LINKAGE

Adjust Hand Throttle Linkage .....	230-15-01
Adjust Fuel Shut-Off Control .....	230-15-02
Adjust Foot Throttle Linkage .....	230-15-02

**<https://www.ebooklibonline.com>**

Hello dear friend!

Thank you very much for reading.

Enter the link into your browser.

The full manual is available for immediate download.

**<https://www.ebooklibonline.com>**