

3050, 3350 and 3650 Tractors

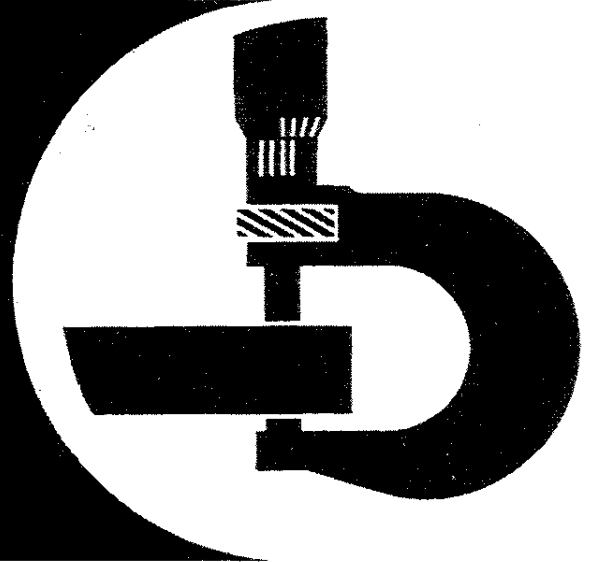

John Deere Werke Mannheim
TM4443 (Nov-90)
PRINTED IN GERMANY
ENGLISH



SUMMARY OF MOST IMPORTANT SPECIFICATIONS FOR 3050, 3350 and 3650 TRACTORS

NOTE: For further specifications, see relevant Technical Manual.

ENGINE

Valve clearance (engine hot or cold):	
Intake valves	0.35 mm (0.014 in.)
Exhaust valves	0.45 mm (0.018 in.)
Minimum engine oil pressure at 800 rpm and normal operating temperature	
	100 kPa (1 bar; 14 psi)
Compression	
	2100 kPa (21 bar; 300 psi)
Maximum difference in pressure between cylinders	
	350 kPa (3.5 bar; 50 psi)
Maximum blow-by at crankcase vent tube	
	80 l/kWh (2.8 cu.ft./kWh)
Rocker arm shaft to cylinder head	
	50 Nm (35 ft-lb)
Cylinder head to cylinder block (cap screws dipped in oil)	
1st step	85 Nm (65 ft-lb)
2nd step	135 Nm (100 ft-lb)
3rd step	+60°
Rocker cover to cylinder head	
	10 Nm (7 ft-lb)
Connecting rod cap screws (dipped in oil)	
	65 to 75 Nm (50 to 55 ft-lb)
Main bearings to cylinder block	
	120 Nm (85 ft-lb)
Flywheel to crankshaft	
	160 Nm (120 ft-lb)
Front axle carrier to engine	
<i>without increased lifting capacity</i>	230 Nm (170 ft-lb)
<i>with increased lifting capacity and 3650</i>	
upper TORX screws	100 Nm (75 ft-lb) + 60°
lower TORX screws	250 Nm (185 ft-lb)
Oil pan to front axle carrier	
	400 Nm (300 ft-lb)
Oil pan to clutch housing	
<i>without increased lifting capacity</i>	230 Nm (170 ft-lb)
<i>with increased lifting capacity and 3650</i>	400 Nm (300 ft-lb)
Clutch housing to engine	
<i>without increased lifting capacity</i>	230 Nm (170 ft-lb)
<i>with increased lifting capacity and 3650</i>	
upper and upper right-hand TORX screws	
	120 Nm (85 ft-lb) + 120°
upper left-hand TORX screw	
	120 Nm (85 ft-lb) + 90°
lower TORX screws	
	120 Nm (85 ft-lb) + 72°
Side frames to front axle carrier	
<i>without increased lifting capacity</i>	230 Nm (170 ft-lb)
<i>with increased lifting capacity and 3650</i>	
TORX screws	
	400 Nm (300 ft-lb)
Side frames to flywheel housing	
<i>without increased lifting capacity</i>	230 Nm (170 ft-lb)
<i>with increased lifting capacity and 3650</i>	
upper and lower cap screws	
	575 Nm (425 ft-lb)
center cap screws	
	325 Nm (240 ft-lb)

FUEL INJECTION NOZZLES

Opening pressure of a new or re- conditioned nozzle with new spring	
- Engine without turbocharger	21700 to 22400 kPa (217 to 224 bar; 3150 to 3250 psi)
- Engine with turbocharger	25100 to 25800 kPa (251 to 258 bar; 3650 to 3750 psi)
Minimum opening pressure with used nozzle	
- Engine without turbocharger	20700 kPa (207 bar; 3000 psi)
- Engine with turbocharger	24100 kPa (241 bar; 3500 psi)
Maximum difference in opening pressure	
	700 kPa (7 bar; 100 psi)
Fuel injection nozzle to cylinder head	
	30 Nm (23 ft-lb)

BATTERIES

Cold state testing current	395 amps.
----------------------------	-----------

ENGINE CLUTCH

Thickness of a new disk	10 mm (0.39 in.)
Wear limit	7 mm (0.26 in.)
Maximum permissible warpage of clutch disk	
	0.5 mm (0.02 in.)
Flywheel to crankshaft	
	160 Nm (120 ft-lb)
Clutch to flywheel	
	50 Nm (35 ft-lb)
Clutch pedal free play (mechanical operated clutch)	
	25 mm (approx. 1 in.)

HI-LO SHIFT UNIT

Operating pressure at 1500 rpm	
	1050 kPa (10.5 bar; 150 psi)
Operating pressure of automatic shift valve	
	500 to 700 kPa (5 to 7 bar; 75 to 100 psi)
Hi-Lo shift unit to clutch housing	
	50 Nm (35 ft-lb)

SYNCHRONIZED TRANSMISSION

Differential drive shaft

Rolling drag torque with	
New bearings	0.75 to 1.5 Nm (6.5 to 13 in-lb)
Used bearings	0.4 to 0.75 Nm (3.5 to 6.5 in-lb)
Special hex. nut or special nut of differential drive shaft	
	140 Nm (100 ft-lb)



SUMMARY OF MOST IMPORTANT SPECIFICATIONS FOR 3050, 3350 and 3650 TRACTORS

SYNCHRONIZED TRANSMISSION (Contd.)

Range shaft

Preload of taper roller bearings 0.05 to 0.10 mm
(0.002 to 0.004 in.)

Countershaft

Preload of transmission hollow drive shaft taper roller bearings 0.05 to 0.10 mm
(0.002 to 0.004 in.)

Rolling drag torque 1 to 2 Nm (9 to 18 in-lb)

End play of transmission drive shaft 0.03 to 0.13 mm
(0.001 to 0.005 in.)

Hex. nut of transmission hollow drive shaft 140 Nm (100 ft-lb)
Countershaft bearing quill 120 Nm (85 ft-lb)

Intermediate shaft

Preload of bearings 0.05 to 0.10 mm
(0.002 to 0.004 in.)

Grooved nut 140 Nm (100 ft-lb)

Clutch housing to transmission case *without increased lifting capacity* 160 Nm (120 ft-lb)
with increased lifting capacity and 3650

upper cap screws 260 Nm (190 ft-lb)

Upper left and right-hand TORX screws 100 Nm (75 ft-lb) + 60°

Remaining TORX screws 100 Nm (75 ft-lb) + 40°

TRANSMISSION OIL PUMP

Minimum delivery of transmission oil pump with:

Oil temperature 40°C (100°F) and 2000 rpm 42 liters/min. (11 gpm)

Oil temperature 65°C (150°F) and 2000 rpm 38 liters/min. (10 gpm)

Minimum flow to hydraulic pump with: Oil temperature 40°C (100°F) and 2000 rpm 38 l/min (10 gpm)

Oil temperature 65°C (150°F) and 2000 rpm 34 l/min (9 gpm)

Transmission oil pump cap screws 55 Nm (40 ft-lb)

Transmission oil pump to clutch housing 55 Nm (40 ft-lb)

DIFFERENTIAL

Preload of taper roller bearings 0.15 to 0.25 mm
(0.006 to 0.01 in.)

Backlash between ring gear and differential drive shaft pinion 0.30 mm (0.012 in.)

FINAL DRIVES

To measured rolling drag torque of final drive housing (before tightening 12-point screw) add 10 to 13.5 Nm
(7 to 10 ft-lb)

Final drives to transmission case 230 Nm (170 ft-lb)

PTO

Operating pressure at 1500 rpm 1050 kPa
(10.5 bar; 150 psi)

Drive gear to clutch drum 75 Nm (55 ft-lb)

Bearing quill to transmission case 115 Nm (85 ft-lb)

Preload of taper roller bearings (handshift PTO) 0.05 to 0.15 mm
(0.002 to 0.006 in.)

PTO shaft cover to bearing quill (handshift PTO) 30 Nm (23 ft-lb)

FRONT PTO

Operating pressure at 1500 rpm 1050 kPa
(10.5 bar; 150 psi)

Preload of taper roller bearings 0 to 0.05 mm (0 to 0.002 in.)

Front PTO to front axle carrier 400 Nm (300 ft-lb)

FRONT WHEEL DRIVE

Operating pressure at 1500 rpm 1050 kPa
(10.5 bar, 150 psi)

Disk clutch slips at a torque of: *3050 and 3350 without front PTO* 1000 Nm (740 ft-lb)

3050 and 3350 with front PTO and 3650 1300 Nm (960 ft-lb)

Clutch shaft taper roller bearings Preload 0.02 mm (0.0008 in.)

Up to axial play of 0.03 mm (0.0012 in.)

Front axle to front axle carrier 300 Nm (220 ft-lb)

Front axle axial play 0 to 0.5 mm (0 to 0.02 in.)

Universal-jointed drive shaft to drive hub 75 Nm (55 ft-lb)

STEERING

Adjustment pressure of double-acting shock valves 21000 kPa
(210 bar; 3050 psi)

Steering valve to steering column 50 Nm (35 ft-lb)

BRAKES

Return movement of pressure ring within 15 seconds 0.28 to 0.35 mm
(0.011 - 0.014 in.)

Test pressure for leakage test of pressure ring 300 kPa
(3 bar; 44 psi)

Maximum pressure drop within 10 seconds 10 kPa
(0.1 bar; 1.5 psi)

Retraction pin assembly to pressure ring 15 Nm (11 ft-lb)

<https://www.ebooklibonline.com>

Hello dear friend!

Thank you very much for reading.

Enter the link into your browser.

The full manual is available for immediate download.

<https://www.ebooklibonline.com>



SUMMARY OF MOST IMPORTANT SPECIFICATIONS FOR 3050, 3350 and 3650 TRACTORS

HYDRAULIC PUMP

Pump stand-by pressure	19000 kPa (190 bar; 2760 psi)
Minimum delivery at 2000 rpm and 17000 kPa (170 bar; 2450 psi) operating pressure:	
23 cm ³ (1.4 cu.in.) pump	34 l/min (9 gpm)
40 cm ³ (2.4 cu.in.) pump	68 l/min (18 gpm)
Hydraulic pump to front axle carrier	120 Nm (85 ft-lb)

ROCKSHAFT

Opening pressure of pressure relief valve	21000 to 23000 kPa (210 to 230 bar; 3050 to 3340 psi)
Rockshaft to transmission case <i>Without increased lifting capacity</i>	120 Nm (85 ft-lb)
<i>With increased lifting capacity and 3650</i>	
Hexagon socket screws	200 Nm (145 ft-lb)
Cap screws	120 Nm (85 ft-lb)

Adjusting Load Control Arm

Turn in control arm adjusting screw until it contacts arm and then back off	1/3 to 1/2 a turn
---	-------------------

Adjusting Valve Clearance

At commencement of lift turn adjusting screw clockwise	1/4 turn
Front edge of rockshaft control lever (Play between raising and lowering)	
<i>With SG2 cab</i>	12 to 15 mm (0.5 to 0.6 in.)
<i>Without SG2 cab</i>	2 to 4 mm (0.08 to 0.16 in.)

Adjusting Rockshaft Control Lever

<i>With SG2 cab</i>	
Front edge of rockshaft control lever in position	7 to 7.5
<i>Without SG2 cab</i>	
Front edge of rockshaft control lever to front end position of quadrant (measured at upper edge of quadrant)	12 + 1/-2 mm (0.47 +0.04/-0.08 in.)
Adjusting commencement of lift with load control	
<i>With SG2 cab</i>	
Front edge of control lever in position	2 to 2.5
<i>Without SG2 cab</i>	
Rear edge of control lever to rear end position of quadrant (measured at upper edge of quadrant)	50 ± 3 mm (2 ± 0.12 in.)

FRONT AXLE

Maximum permissible axial play of knuckle and spindle assy. in axle knee	0.76 mm (0.03 in.)
Front axle axial play	0 to 0.4 mm (0 to 0.015 in.)
Bearing pin to front axle carrier	100 Nm (75 ft-lb)
Axle knees to axle center	400 Nm (300 ft-lb)
Steering arm to knuckle and spindle assy.	230 Nm (170 ft-lb)

FRONT WHEELS

Wheel hub to axle spindle	50 Nm (35 ft-lb)
Steel disk to rim	
Bolts M16 × 120	250 Nm (185 ft-lb)
Bolts M16 × 74	280 Nm (210 ft-lb)
Wheel rim to hub	
<i>Without front wheel drive</i>	
Wheel bolts with cone	150 Nm (110 ft-lb)
Wheel bolts without cone	240 Nm (175 ft-lb)
<i>With front wheel drive</i>	300 Nm (220 ft-lb)
Front wheel toe-in	
<i>Without front wheel drive</i>	3 to 6 mm (1/8 to 1/4 in.)
<i>With front wheel drive</i>	0 to 3 mm (0 to 1/8 in.)

REAR WHEELS

Flanged Rear Axle

Steel disk to rim	
Bolts M16 × 120	250 Nm (185 ft-lb)
Bolts M16 × 74	280 Nm (210 ft-lb)
Cast disk to rim	230 Nm (170 ft-lb)
Rear wheels to rear axle	400 Nm (300 ft-lb)

Rack-and-Pinion Axle

Wheel rim to hub	
Steel type	400 Nm (300 ft-lb)
Cast type	230 Nm (170 ft-lb)
Pinion sleeve half to wheel hub	215 Nm (160 ft-lb)
Key sleeve half to wheel hub	400 Nm (300 ft-lb)



SUMMARY OF MOST IMPORTANT SPECIFICATIONS FOR 3050, 3350 and 3650 TRACTORS

SG2 CAB or RG2 ROLL-GUARD

SG2 cab or RG2 roll-guard to mounting brackets or final drives 200 Nm (145 ft-lb)
 Studs in final drive housings 35 Nm (25 ft-lb)

2-POST ROLL-GUARD

Supports of final drives 400 Nm (300 ft-lb)
 Supports to crossmember 230 Nm (170 ft-lb)

4-POST ROLL-GUARD

Roll-guard to fender 120 Nm (85 ft-lb)
 Fender to final drive 230 Nm (170 ft-lb)

CAPACITIES

Cooling system
Without SG2 cab 17 liters (4.5 U.S.gal.)
With SG2 cab 19 liters (5.0 U.S. gal.)

Crankcase
 Initial filling 12 liters (3.1 U.S.gal.)
 Oil change and renew filter 11.5 liters (3.0 U.S.gal.)

Transmission/Hydraulic System (with oil reservoir and oil cooler)

Initial filling
Without front wheel drive 53 liters (14.0 U.S.gal.)
With front wheel drive 56 liters (14.8 U.S.gal.)
With front PTO 58 liters (15.3 U.S.gal.)

Oil change and renew filter
Without front wheel drive 50 liters (13.2 U.S.gal.)
With front wheel drive 53 liters (14.0 U.S.gal.)
With front PTO 55 liters (14.55 U.S.gal.)

Front Wheel Drive

Front axle housing 7 liters (1.85 U.S.gal.)
 Wheel hub housings, each 0.75 liters (0.2 U.S.gal.)

Hydraulic Operated Clutch 250 cm³ (8.75 fl.oz.)

Air Conditioning System 1.8 kg (4 lb)

3050, 3350 AND 3650 TRACTORS TECHNICAL MANUAL TM4443 (Nov-90)

SECTION CONTENTS IN GROUPS – REPAIR

05 – SAFETY

10 – GENERAL

- 05 – Specifications
- 10 – Predelivery, delivery and after-sales inspections
- 15 – Lubrication and service
- 20 – Tune-up
- 25 – Tractor separation

20 – ENGINE

- 05 – Radiator, viscous fan drive and fan

30 – FUEL AND AIR INTAKE SYSTEM

- 05 – Fuel tank, auxiliary tank and water trap
- 10 – Cold weather starting aids
- 15 – Speed control linkage
- 20 – Air cleaner

40 – ELECTRICAL SYSTEM

- 05 – Wiring harnesses
- 10 – Controls and instruments (with SG2 cab)
- 15 – Controls and instruments (without SG2 cab)
- 16 – Adjusting digital speed-hour-meter
- 20 – Lighting system
- 25 – Starting motor
- 30 – Alternator

50 – POWER TRAIN

- 05 – Clutch operating systems
- 10 – Engine clutch
- 15 – Hi-Lo shift unit
- 20 – Creeper transmission
- 21 – Hydrostatic creeper transmission
- 25 – Transmission – console shift
- 30 – Transmission – center shift
- 35 – Synchronized transmission and transmission oil pump
- 40 – Differential
- 45 – Final drives
- 50 – PTO
- 55 – Front PTO
- 60 – Front wheel drive u.j. drive shaft and disk clutch

60 – STEERING SYSTEM AND BRAKES

- 05 – Hydrostatic steering
- 10 – Steering cylinder (without front wheel drive)
- 15 – Hydraulic brakes
- 20 – Handbrake
- 25 – Hydraulic trailer brake

70 – HYDRAULIC SYSTEM

- 05 – Valves
- 10 – Hydraulic pumps
- 15 – Rockshaft
- 20 – Front hitch
- 25 – Selective control valves (spool type)
- 30 – Selective control valves (poppet valve type)

COPYRIGHT © 1990 DEERE & CO.
European Office Mannheim
All rights reserved
A John Deere ILLUSTRATION™ Manual
PREVIOUS EDITIONS
COPYRIGHT © 1987, 1989

INHALT-LB201AE-010490

SECTION CONTENTS IN GROUPS – REPAIR

70 – HYDRAULIC SYSTEM (CONTD.)

- 35 – ISO breakaway couplers
- 40 – ISO quick couplers
- 45 – Remote cylinder







80 – MISCELLANEOUS

- 05 – Front axle
- 10 – Front and rear wheels
- 15 – AXLA trailer hitch
- 20 – Trailer hitch (height adjustable)

90 – SG2 CAB

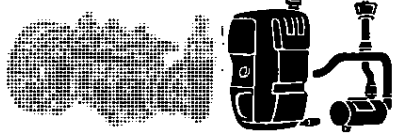
- 05 – Safe handling of refrigerants
- 06 – Servicing air conditioning system
- 07 – Compressor (up to tractor serial no. 646 949L)
- 08 – Compressor (from tractor serial no. 646 950L)
- 09 – Components of air conditioning system
- 10 – Cab ventilation and heating
- 15 – Cab ventilation and heating
(low profile cab)
- 20 – Operator's seats
- 25 – SG2 cab
- 30 – 2-post roll guard
- 35 – 4-post roll guard
- 40 – RG2 roll guard

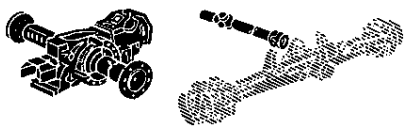
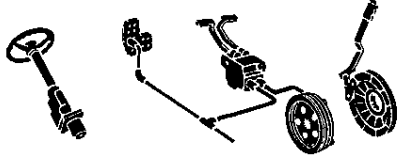
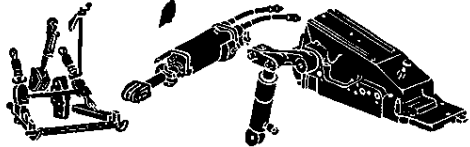
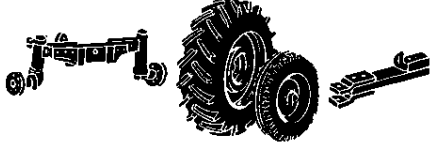
INHALT-LB202AE-010488

SAFETY	 05
GENERAL	 10
ENGINE	 20
FUEL AND AIR INTAKE SYSTEM	 30
ELECTRICAL SYSTEM	 40
POWER TRAIN	 50
STEERING SYSTEM AND BRAKES	 60
HYDRAULIC SYSTEM	 70
MISCELLANEOUS	 80
OPERATOR'S STATION	 90

FX 100006 19

FX100006 19-LB303AE-010490

SAFETY AND YOU

This is the safety-alert symbol. When you see this symbol on the machine or in this manual, be alert to the potential for personal injury.



T 81389

T81389;053;TMSAFE 19 07OCT85

IMPORTANT

The IMPORTANT message identifies potential problems which may cause consequential damage to machine. Following recommended procedure will instruct technician how to avoid problem.

A68;N01;0000 19 U 05NOV82

NOTES

The word NOTE is followed by a statement that identifies a qualification or exception to a previous statement. A "NOTE" may also identify nice-to-know information pertinent to, but not directly related to previous statement.

A68; N01;0000 19 V 05NOV82

OBSERVE SAFETY RULES

Avoid loose clothing that can catch in moving parts and put you out of work.

Wear your safety glasses while on the job.

Avoid working on equipment with the engine running. If it is necessary to make checks with the engine running, **ALWAYS USE TWO PEOPLE** – with the operator, at the controls, able to see the person doing the checking. Also, put the transmission in neutral, set the brake, and apply safety locks provided. **KEEP HANDS AWAY FROM MOVING PARTS.**

Keep transmission and brake control units properly adjusted at all times. Before making adjustments, stop engine.

Before removing any housing covers, stop engine. Take all objects from your pockets which could fall into the opened housings. Don't let adjusting wrenches fall into opened housings.

Don't attempt to check belt tension while the engine is running.

Don't adjust the fuel system while the machine is in motion.

Before repairing the electrical system, or performing a major overhaul, make sure the batteries are disconnected.

A69; N01;0000 19 S 05NOV82

PREPARE FOR EMERGENCIES

Be prepared if a fire starts.

Keep a first aid kit and fire extinguisher handy.

Keep emergency numbers for doctors, ambulance service, hospital and fire department near your telephone.

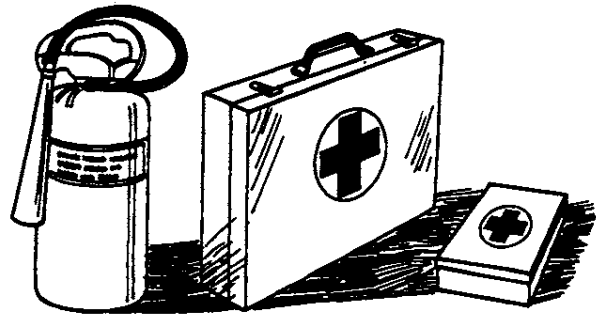

L 114 052

L114052;053;FIR2 19 15MAR89

WORK IN CLEAN AREA

Before starting a job:

- Clean work area and machine.
- Make sure you have all necessary tools to do your job.
- Have the right parts on hand.
- Read all instructions thoroughly; do not attempt shortcuts.

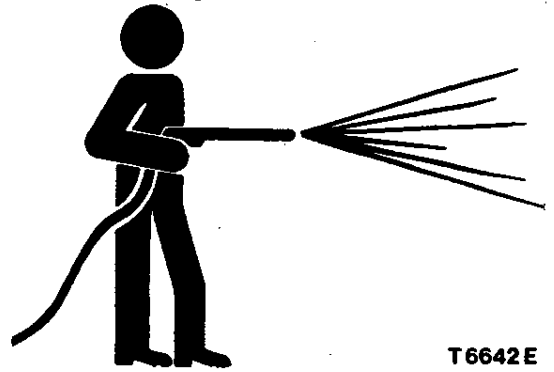

T6642 E

T6642E;053;CLEAN 19 19JAN88

WORK IN VENTILATED AREA

Engine exhaust fumes can cause sickness or death. If it is necessary to run an engine in an enclosed area, remove the exhaust fumes from the area with an exhaust pipe extension.

If you do not have an exhaust pipe extension, open the doors and get outside air into the area.

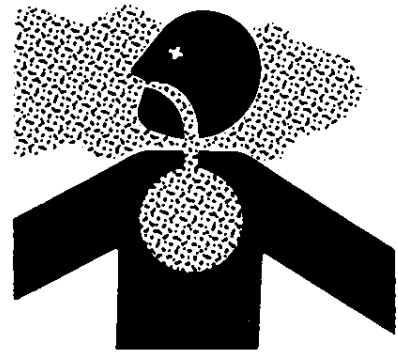

TS 220

TS220;053;AIR 19 05JAN88

PARK MACHINE SAFELY

Before working on the machine:

- Lower all equipment to the ground.
- Stop the engine and remove the key:
- Disconnect the battery ground strap.
- Hang a "DO NOT OPERATE" tag in operator station.

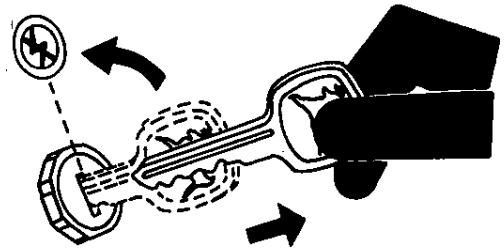

TS 230

TS230;053;PARK 19 05JAN88

USE PROPER LIFTING EQUIPMENT

Lifting heavy components incorrectly can cause severe injury or machine damage.

Follow recommended procedure for removal and installation of components in the manual.

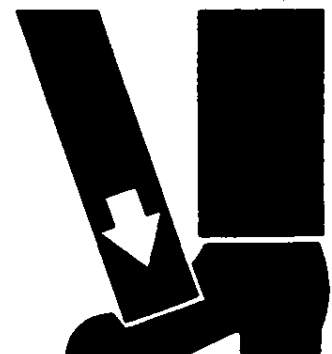

TS 226

TS226;053;LIFT 19 05JAN88

SUPPORT MACHINE PROPERLY

Always lower the attachment or implement to the ground before you work on the machine. If you must work on a lifted machine or attachment, securely support the machine or attachment.

Do not support the machine on cinder blocks, hollow tiles or props that may crumble under continuous load. Do not work under a machine that is supported solely by a jack. Follow recommended procedures in this manual.

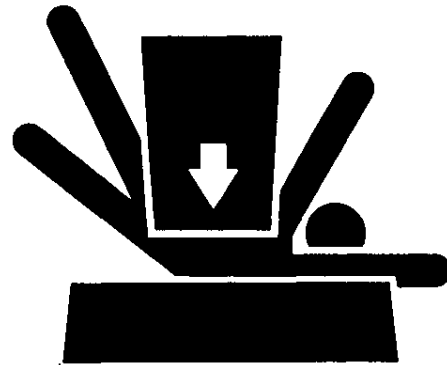

TS 229

TS229;053;LOWER 19 21DEC87

SERVICE FRONT-WHEEL DRIVE TRACTOR SAFELY

When servicing front-wheel drive tractor with the rear wheels supported off the ground and rotating wheels by engine power, always support front wheels in a similar manner. Loss of electrical power or transmission/hydraulic system pressure will engage the front driving wheels, pulling the rear wheels off the support if front wheels are not raised. Under these conditions, front drive wheels can engage even with switch in disengaged position.

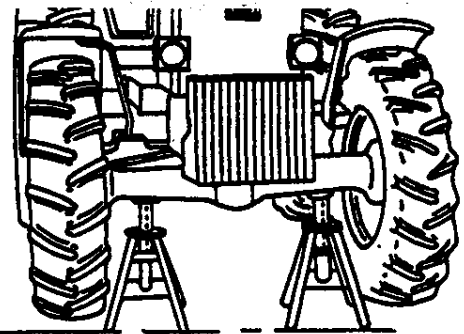

L114050

L114050-ESFDAE-140388

SERVICE HYDROSTATIC CREEPER TRANSMISSION SAFELY

Service work on the hydrostatic creeper transmission may be performed with the engine running only if front and rear wheels are raised and the tractor is safely supported.

Loss of electric power or transmission/hydraulic system pressure will engage hydrostatic creeper transmission, even if the toggle switch is in "OFF" position. Tractor could then start to move if wheels are in contact with the ground.



FXB 04001 UN

FXB04001UN, HYDRO1G 070290

PREVENT MACHINE RUNAWAY

Avoid possible injury or death from a machine runaway.

Do not start the engine by shorting across starter terminals. Machine will start in gear if normal circuitry is bypassed.

NEVER start engine while standing on ground. Start engine only from operator's seat, with the transmission in neutral or "Park".



TS177

TS177;053;BYPAS1 19 21MAY85

SERVICE MACHINE SAFELY

Tie long hair behind your head. Do not wear a necktie, scarf, loose clothing or necklace when you work near machine tools or moving parts. If these items were to get caught, severe injury could result.

Remove rings and other jewelry to prevent electrical shorts and entanglement in moving parts.

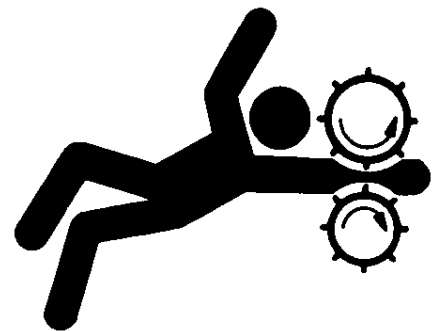

TS228

TS228;053;LOOSE 19 21DEC87

UNDERSTAND CORRECT SERVICE

Illuminate your work area adequately but safely. Use a portable safety light for working inside or under the machine. Make sure the bulb is enclosed by a wire cage. The hot filament of an accidentally broken bulb can ignite spilled fuel or oil.

Catch draining fuel, oil, or other fluids into suitable containers. Do not use food or beverage containers that may mislead someone into drinking from them. Wipe up spills at once.

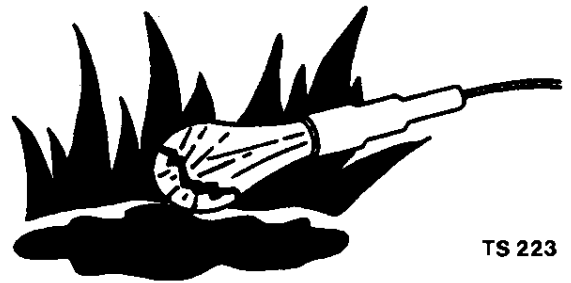

TS 223

TS223;053;LIGHT 19 23FEB88

USE TOOLS PROPERLY

Use tools appropriate to the work. Makeshift tools, parts, and procedures will not make good repairs.

Use pneumatic and electric tools only to loosen threaded parts and fasteners. Never use such tools to tighten fasteners, especially on light alloy parts.

Use only replacement parts meeting John Deere specifications.

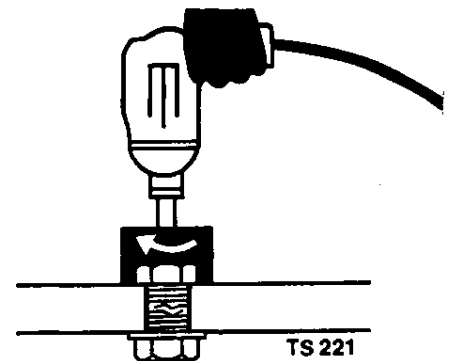

TS 221

TS221;053;REPAIR 19 21DEC87

HANDLE FLUIDS SAFELY – AVOID FIRES

When you work around fuel, do not smoke or work near heaters or other fire hazards.

Store flammable fluids away from fire hazards. Do not incinerate or puncture pressurized containers.

Make sure machine is clean of trash, grease and debris.

Do not store oily rags; they can ignite and burn spontaneously.



TS 227

TS227;053;FLAME 19 05JAN88

AVOID HIGH-PRESSURE FLUIDS

Escaping fluid (fuel or hydraulic oil) under pressure can penetrate the skin causing serious injury. Relieve pressure before disconnecting hydraulic or other lines. Tighten all connections before applying pressure. Keep hands and body away from pinholes and nozzles which eject fluids under high pressure. Use a piece of cardboard to search for leaks.

If ANY fluid is injected into the skin, it must be surgically removed within a few hours by a doctor familiar with this type of injury, or gangrene may result.



X9811

X9811;053;FLUID 19 18SEP87

REMOVE PAINT BEFORE WELDING OR HEATING

Avoid potentially toxic fumes and dust.

Hazardous fumes can be generated when paint is heated by welding, soldering, or using a torch.

Do all work outside or in a well ventilated area. Dispose of paint and solvent properly.

Remove paint before welding or heating:

- If you sand or grind paint, avoid breathing the dust. Wear an approved respirator.
- If you use solvent or paint stripper, remove stripper with soap and water before welding. Remove solvent or paint stripper containers and other flammable material from area. Allow fumes to disperse at least 15 minutes before welding or heating.

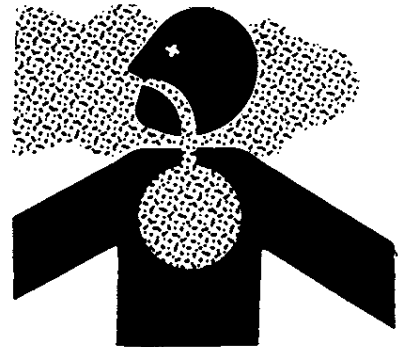

TS 220

TS220-ESPDAE-040690

AVOID HEATING NEAR PRESSURIZED FLUID LINES

Flammable spray can be generated by heating near pressurized fluid lines, resulting in severe burns to yourself and bystanders. Do not heat by welding, soldering, or using a torch near pressurized lines or other flammable materials.

Pressurized lines can be accidentally cut when heat goes beyond the immediate flame area. Install fire resisting guards to protect hoses or other materials.



TS 953

TS953-ESPDAE-040690

AVOID HARMFUL ASBESTOS DUST

Avoid breathing dust that may be generated when handling components containing asbestos fibers. Inhaled asbestos fibers may cause lung cancer.

Components in John Deere products that may contain asbestos fibers are brake pads, brake band and lining assemblies, clutch plates and some gaskets. The asbestos used in these components is usually found in a resin or sealed in some way. Normal handling is not hazardous as long as airborne dust containing asbestos is not generated.

Avoid creating dust. Never use compressed air for cleaning. Avoid brushing or grinding of asbestos-containing materials. When servicing, wear an approved respirator. A special vacuum cleaner is recommended to clean asbestos. If not available, wet the asbestos-containing materials with a mist of oil or water.

Keep bystanders away from the area.

Please note designations on spare parts.

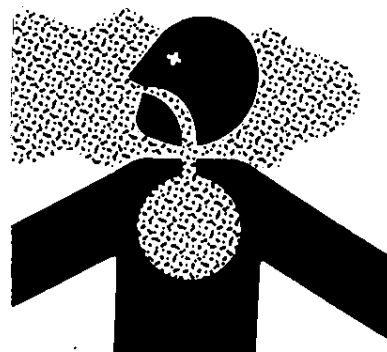

TS 220



L 114 051

TS220,L114051;053;DUST 19 14APR88

PREVENT ACID BURNS

Sulfuric acid in battery electrolyte is poisonous. It is strong enough to burn skin, eat holes in clothing and cause blindness if splashed into eyes.

Avoid the hazard by:

1. Filling the batteries in a well-ventilated area.
2. Wearing eye protection and rubber gloves.
3. Avoiding breathing fumes when electrolyte is added.
4. Avoiding spilling or dripping electrolyte.
5. Use proper jump start procedure.

If you spill acid on yourself:

1. Flush your skin with water.
 2. Apply baking soda or lime to help neutralize the acid.
 3. Flush your eyes with water for 10 – 15 minutes.
- Get medical attention immediately.

If acid is swallowed:

1. Drink large amounts of water or milk.
2. Then drink milk of magnesia, beaten eggs or vegetable oil.
3. Get medical attention immediately.

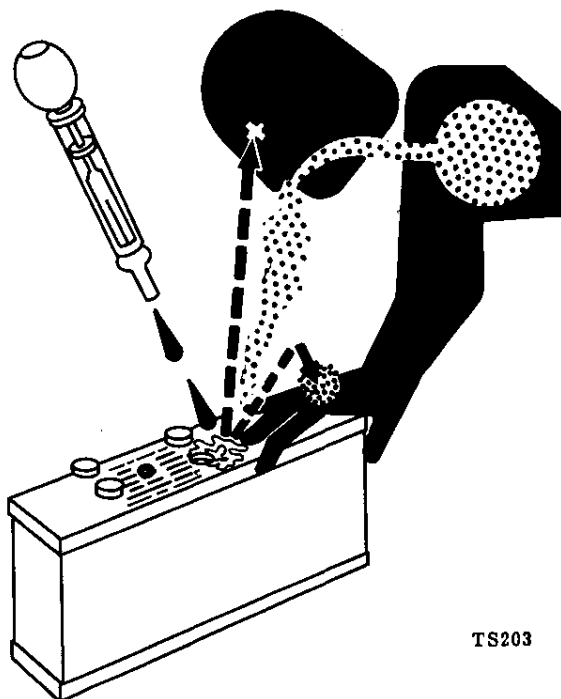

TS203

TS203;053;POISON 19 21DEC87

PREVENT BATTERY EXPLOSIONS

Keep sparks, lighted matches, and open flame away from the top of battery. Battery gas can explode.

Never check battery charge by placing a metal object across the posts. Use a volt-meter or hydrometer.

Do not charge a frozen battery; it may explode. Warm battery to 16°C (60°F).

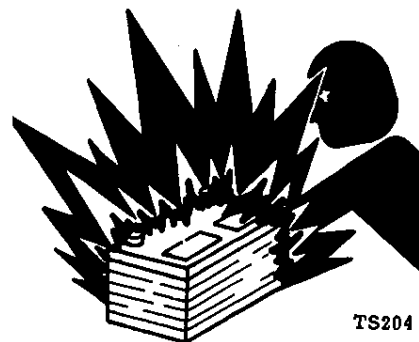

TS204

TS204;053;SPARKS 19 28JUN88

SERVICE TIRES SAFELY

Explosive separation of a tire and rim parts can cause serious injury or death.

Only attempt to mount a tire if you have the proper equipment and experience to perform the job.

Always maintain the correct tire pressure. Do not inflate tires above the recommended pressure.

When inflating tires, use a clip-on chuck and extension hose long enough to allow you to stand to one side and NOT in front of or over the tire assembly. Use a safety cage if available.

Check wheels for low pressure, cuts, bubbles, damaged rims or missing lug bolts and nuts.

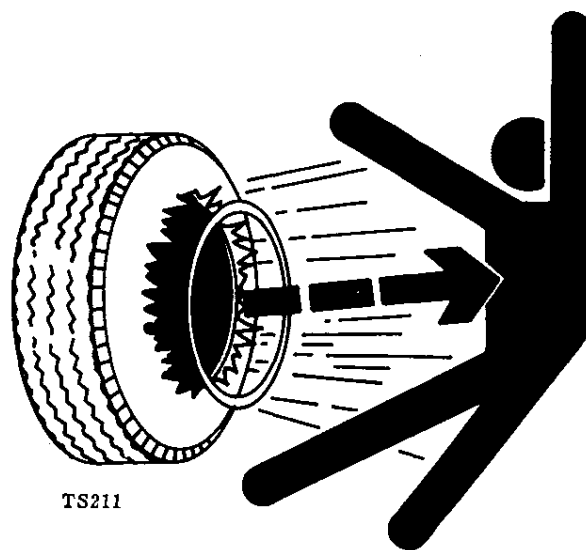

TS211

TS211;053;RIM 19 21DEC87

KEEP CAB/ROPS INSTALLED PROPERLY

Make certain all parts are reinstalled correctly if the cab or roll-over protective structure (ROPS) is loosened or removed for any reason. Tighten mounting bolts to specified torque.

Protection offered by cab or ROPS is impaired if subjected to structural damage, is involved in an overturn incident or is altered in any way by welding, bending, drilling or cutting. A damaged cab or ROPS should be replaced, not reused.

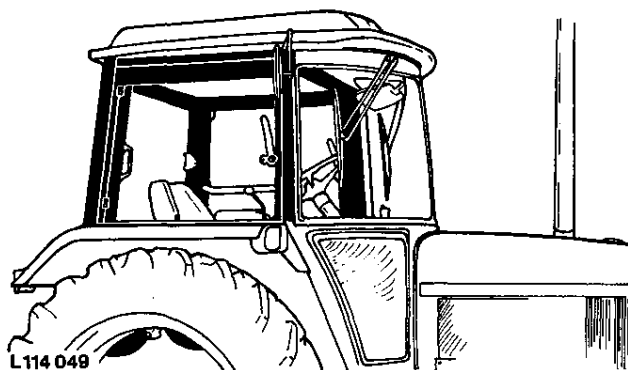

L114 049

L114049;053;ROPS 19 15MAR89

REPLACE SAFETY SIGNS

Replace missing or damaged safety signs. See the machine operator's manual for correct safety sign placement.

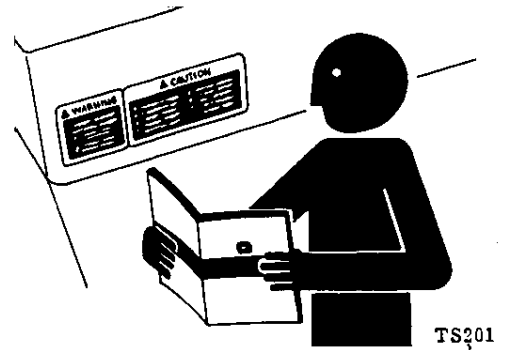

TS201

TS201,053;SIGNS1 19 22DEC87

OBSERVE ENVIRONMENTAL PROTECTION REGULATIONS

Be mindful of the environment and ecology.

Before draining any fluids, find out the correct way of disposing of them.

Observe the relevant environmental protection regulations when disposing of oil, fuel, coolant, brake fluid, filters and batteries.

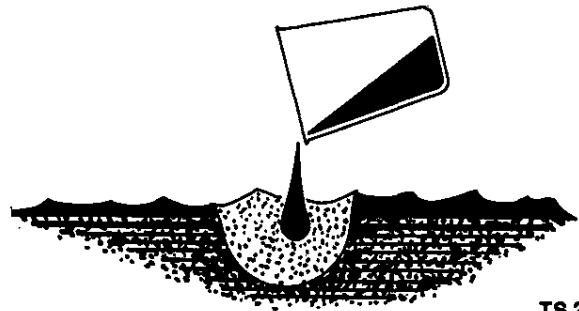

TS 222

TS222-ESPDAE-140388

Group 10 GENERAL

05 - SPECIFICATIONS

	3050	3350	3650
Specifications	X	X	X
- Serial number plates	X	X	X
- Product identification number	X	X	X
- Engine serial number	X	X	X
- Transmission serial number	X	X	X
- Front wheel drive axle serial number	X	X	X
- SG2 cab serial number	X	X	X
- RG2 roll guard serial number	X	X	X
- Model serial numbers	X	X	X
- Engine	X	X	X
- Engine clutch	X	X	X
- Cooling system	X	X	X
- Fuel system	X	X	X
- Electrical system	X	X	X
- Synchronized transmission	X	X	X
- Hi-Lo shift unit	X	X	X
- Creeper transmission	X	X	X
- Differential and final drives	X	X	X
- Differential lock	X	X	X
- PTO	X	X	X
- Front PTO	X	X	X
- PTO speeds	X	X	X
- Front wheel drive	X	X	X
- Hydrostatic steering	X	X	X
- Foot brakes	X	X	X
- Hand brake	X	X	X
- Hydraulic system	X	X	X
- Rockshaft	X	X	X
- Front hitch	X	X	X
- Ground travel speeds	X	X	X
- Front and rear wheels	X	X	X
- Dimensions and weights	X	X	X
- Capacities	X	X	X
- Standard torques for hardware	X	X	X

ALLGEM-LB21001AE-010488

10 – PREDELIVERY, DELIVERY AND AFTER-SALES INSPECTIONS

	3050	3350	3650
Special tools	X	X	X
Specifications	X	X	X
Capacities	X	X	X
Torques for hardware	X	X	X
Predelivery inspection	X	X	X
Delivery inspection	X	X	X
After-sales inspection	X	X	X

15 – LUBRICATION AND SERVICE

Capacities and service intervals	15-1	X	X	X
Lubricants and service intervals	15-2	X	X	X
General	15-3	X	X	X
Engine oil	15-3	X	X	X
Transmission/hydraulic oil	15-4	X	X	X
Oil for front wheel drive axle	15-4	X	X	X
EP multi-purpose grease	15-5	X	X	X
Storing lubricants	15-5	X	X	X
Brake fluid for hydraulic operated clutch	15-5	X	X	X
Engine coolant	15-6	X	X	X
Checking engine oil level	15-6	X	X	X
Changing engine oil	15-7	X	X	X
Changing engine oil filter	15-7	X	X	X
Checking fuel filter	15-8	X	X	X
Replacing fuel filter	15-8	X	X	X
Replacing coolant	15-9	X	X	X
Checking transmission/hydraulic system oil level	15-10	X	X	X
Changing transmission/hydraulic oil	15-11	X	X	X
Replacing transmission/hydraulic oil filter element	15-12	X	X	X
Replacing hydraulic oil return flow filter	15-12	X	X	X
Replacing hydrostatic steering filter (without SG2 cab or RG2 roll guard)	15-13	X	X	

15 – LUBRICATION AND SERVICE (CONTD.)

		3050	3350	3650
Cleaning hydraulic pump filter strainer	15-13	X	X	X
Replacing brake fluid (with hydraulic operated clutch)	15-13	X	X	X
Checking axle housing oil level	15-14	X	X	X
Checking oil level in wheel hub housings	15-14	X	X	X
Changing front axle oil	15-14	X	X	X
Cleaning and repacking front wheel bearings with grease	15-15	X	X	X
Cleaning lubricating points	15-15	X	X	X
Lubricating throw-out bearing on mechanical operated clutch	15-15	X	X	
Lubricating front wheel bearings	15-16	X	X	
Lubricating front axle (without front wheel drive)	15-16	X	X	
Lubricating front axle carrier	15-16	X	X	X
Lubricating oscillating support (with front wheel drive)	15-16	X	X	X
Lubricating front wheel drive axle	15-17	X	X	X
Lubricating universal-jointed drive shaft (with front wheel drive)	15-17	X	X	X
Lubricating rear axle bearings	15-17	X	X	X
Lubricating three-point hitch	15-18	X	X	X
Lubricating front PTO	15-18		X	X
Lubricating front hitch	15-19		X	X

20 - TUNE-UP

	3050	3350	3650
Specifications	X	X	X
Preliminary engine testing	X	X	X
Checking air cleaner element	X	X	X
Checking air intake system connections for leaks	X	X	X
Checking crankcase vent tube for clogging	X	X	X
Cleaning radiator side panels and grille screens	X	X	X
Cleaning radiator and oil cooler	X	X	X
Cleaning condenser	X	X	X
Checking radiator cap	X	X	X
Checking radiator for leaks	X	X	X
Checking thermostats	X	X	X
Checking fuel transfer pump	X	X	X
Checking fuel filter	X	X	X
Checking fuel tank	X	X	X
Checking auxiliary fuel tank	X	X	X
Checking water trap	X	X	X
Checking fuel injection pump timing	X	X	X
Checking engine slow and fast idle speeds	X	X	X
Checking speed control linkage adjustment	X	X	X
Checking batteries	X	X	X
Checking fan belt tension	X	X	X
Checking compressor belt tension	X	X	X
Checking operation of start safety switch	X	X	X
Checking operation of starting motor	X	X	X
Checking lighting system	X	X	X
Final engine check	X	X	X
Checking tractor operation	X	X	X

25 - TRACTOR SEPARATION

	3050	3350	3650
Special tools	X	X	X
Specifications	X	X	X
Torques for hardware	X	X	X
Capacities	X	X	X
Standard torques for hardware	X	X	X
Important notes	X	X	X
Removing tractor front end	X	X	X
Installing tractor front end	X	X	X
Separating between engine and clutch housing	X	X	X
Joining tractor between engine and clutch housing	X	X	X
Removing engine	X	X	X
Installing engine	X	X	X
Removing clutch housing	X	X	X
Installing clutch housing	X	X	X
Removing transmission	X	X	X
Installing transmission	X	X	X
Removing final drives	X	X	X
Installing final drives	X	X	X
Removing rockshaft	X	X	X
Installing rockshaft	X	X	X
Removing front axle	X	X	
Installing front axle	X	X	
Removing front wheel drive axle	X	X	X
Installing front wheel drive axle	X	X	X
Removing SG2 cab or RG2 roll guard	X	X	X
Installing SG2 cab or RG2 roll guard	X	X	X
Removing front hitch	X	X	X
Installing front hitch	X	X	X
Removing front PTO	X	X	X
Installing front PTO	X	X	X

SPECIFICATIONS

SERIAL NUMBER PLATES

The following illustrations show the serial number plates for tractor major components. The letters and figures on these plates are required for warranty claims and when ordering replacement parts.

TECH0A-LA71005AE-180385

PRODUCT IDENTIFICATION NUMBER PLATE

Tractors Without Front Hitch

The product identification number plate is located on right-hand side of front axle carrier. The chassis number is stamped in front axle carrier next to the identification number plate.

Tractors With Front Hitch

The product identification number plate is located on front side of right-hand battery box. The chassis number is stamped in front axle carrier under the right-hand radiator guard plate.

NOTE: When ordering tractor parts (excluding engine parts), quote all letters and figures of serial number stamped on this plate.

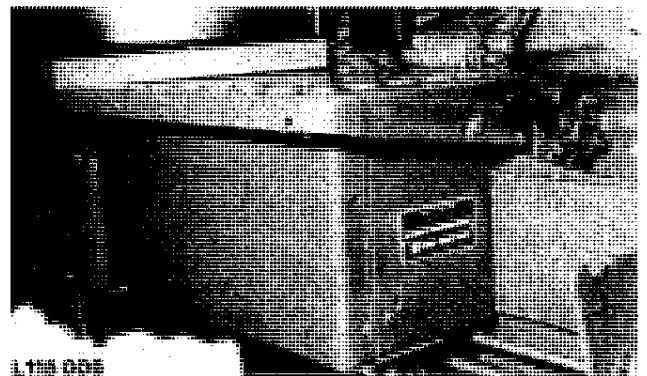
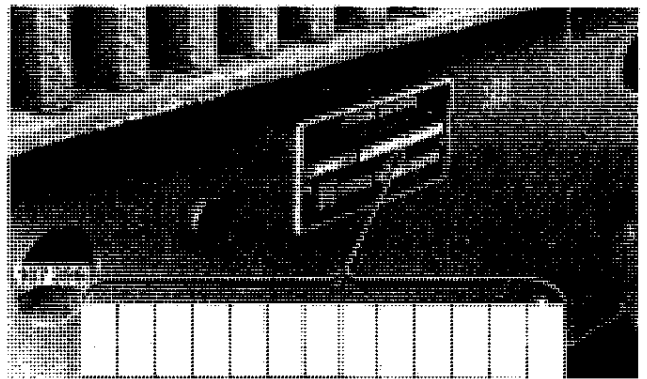

L107396.L115006-LB21005AE-010886

ENGINE SERIAL NUMBER PLATE

The engine serial number plate is located on right-hand side of engine block.

NOTE: The engine serial number plate shows the engine type as well as the engine serial number. When ordering engine parts, quote all figures stamped on this plate.

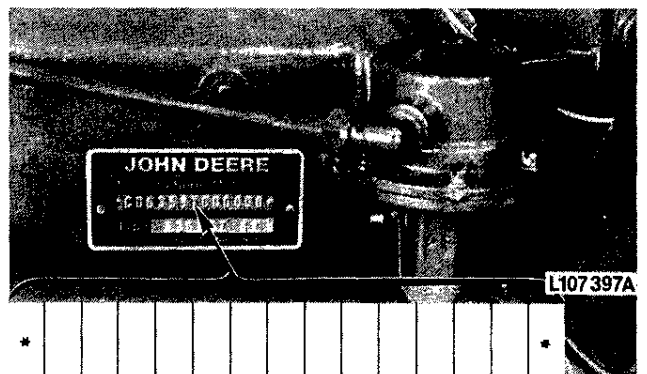

L107397A-LB41005AE-010687

**TRANSMISSION SERIAL NUMBER PLATE
(Tractors Without SG2 Cab or RG2 Roll Guard)**

The transmission serial number plate is located on right-hand side of transmission case.

From tractor serial no. 617 678L an additional serial number plate is attached to left-hand side of dash.

NOTE: In addition to serial number of transmission and transmission type, serial number plate also specifies differential and front wheel drive gear ratios.

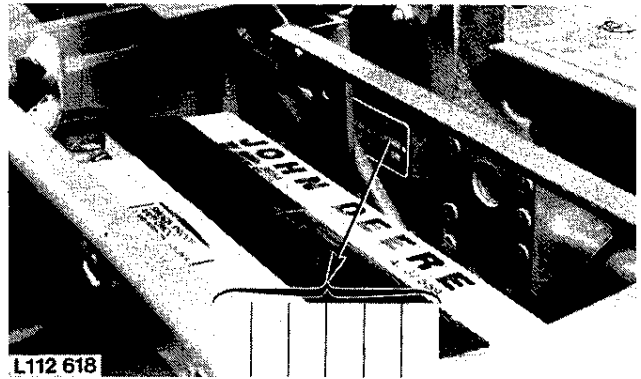

L112618.L119364-LB21005AE-010488

**TRANSMISSION SERIAL NUMBER PLATE
(Tractors With SG2 Cab)**

The transmission serial number plate is located on right-hand side of cab crossmember and on right-hand side of transmission case.

NOTE: In addition to serial number of transmission and transmission type, this serial number plate also specifies differential and front wheel drive gear ratios.

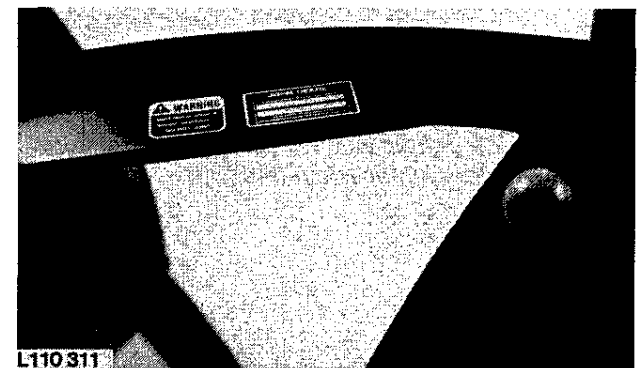

L110311-LB21005AE-010886

**TRANSMISSION SERIAL NUMBER PLATE
(Tractors With RG2 Roll Guard)**

The transmission serial number plate is located to the right of shift console and on right-hand side of transmission case.

NOTE: In addition to serial number of transmission and transmission type, this serial number plate also specifies differential and front wheel drive gear ratios.

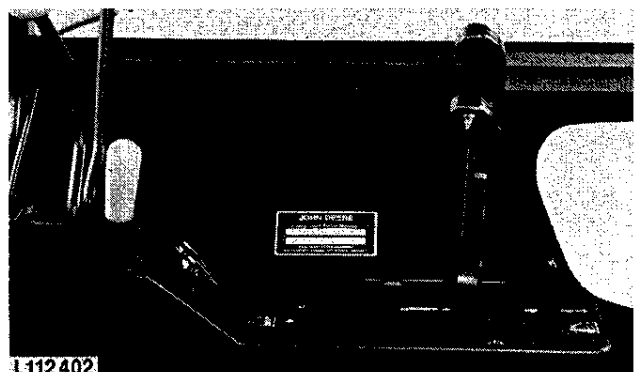

L112402-LB21005AE-010886

Specifications

FRONT WHEEL DRIVE AXLE SERIAL NUMBER PLATE

The front wheel drive axle serial number plate is located on rear of right-hand axle half.

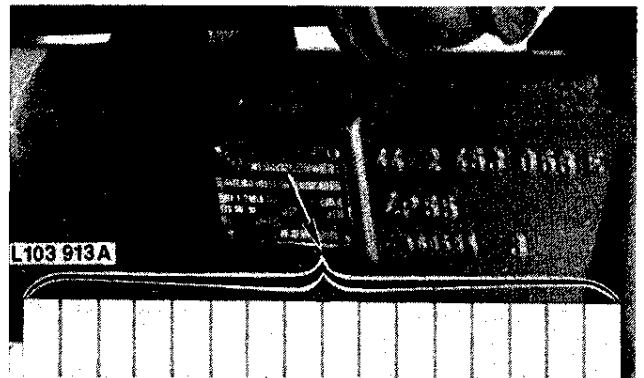

L103913A-LA71005AE-180385

SG2 CAB SERIAL NUMBER PLATE

With cab door open, cab serial number plate is visible in roof recess as you enter the cab.

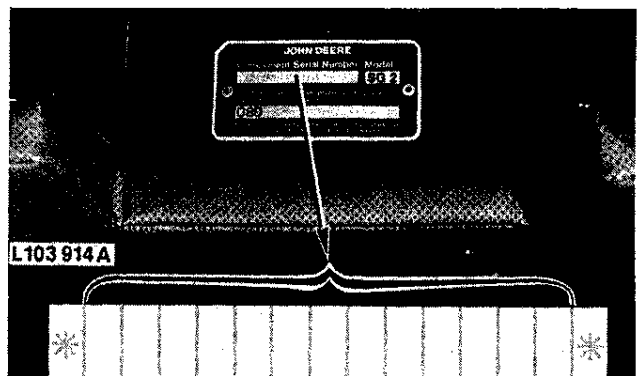

L103914A-LB21005AE-010886

RG2 ROLL GUARD SERIAL NUMBER PLATE

The serial number plate is located on roll guard longitudinal support.

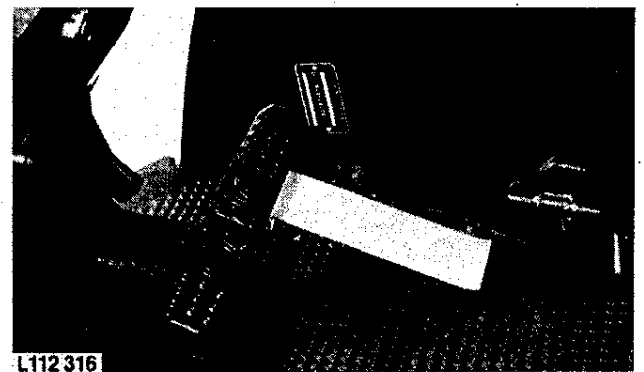

L112316-LB21005AE-010886

MODEL SERIAL NUMBERS

Fuel injection pump, fuel injection nozzles, alternator, starting motor, hydrostatic steering valve, air conditioning system compressor (when equipped) and hydraulic pump have serial numbers to facilitate identification of different makes of a given unit.

TECHDA-LA71005BE-180385

Specifications

ENGINE

Number of cylinders	6
Cylinder liner bore	106.5 mm (4.19 in.)
Stroke	110 mm (4.33 in.)
Displacement	5883 cm ³ (359 cu.in.)
Compression ratio	17.8 : 1
Max. torque at 1400 rpm	
– 3050	340 Nm (250 ft-lb)
– 3350	370 Nm (273 ft-lb)
Max. torque at 1500 rpm	
– 3650	430 Nm (317 ft-lb)
Firing order	1–5–3–6–2–4
Valve clearance (engine hot or cold)	
– Intake valve	0.35 mm (0.014 in.)
– Exhaust valve	0.45 mm (0.018 in.)
Slow idle speed	750 to 850 rpm
Fast idle speed	
– 3050 and 3350	2410 to 2510 rpm
– 3650	2510 to 2610 rpm
Rated engine speed	
– 3050 and 3350	2300 rpm
– 3650	2400 rpm
– Working speed range	
– 3050 and 3350	1400 to 2300 rpm
– 3650	1400 to 2400 rpm
Engine speed for PTO operation	
– 540 rpm PTO	
– 3050 and 3350	2070 rpm
– 3650 with RG2 roll guard	2414 rpm
– 3650	2178 rpm
– 1000 rpm PTO	
– 3050 and 3350	2170 rpm
– 3650 with RG2 roll guard	2407 rpm
– 3650	2172 rpm

TECHDA-LB21005AE-010488

Specifications

Flywheel horsepower at engine rated speed

- According to DIN 70 020	
- 3050	68 kW (92 hp)
- 3350	74 kW (100 hp)
- 3650	84 kW (114 hp)

PTO* horsepower at engine rated speed

- According to DIN 70 020	
- 3050	62 kW (84 hp)
- 3350	67 kW (91 hp)
- 3650	76 kW (103 hp)

- According to SAE J 1349

- 3050	58 kW
- 3350	63 kW
- 3650	74 kW

Lubrication system Full internal force feed system with full flow filter

ENGINE CLUTCH

- Type Single dry disk clutch with torsion damper, foot-operated

COOLING SYSTEM

- Type Pressurized system with centrifugal pump
 - Temperature regulation Two thermostats and when equipped, viscous fan drive

FUEL SYSTEM

- Type Direct injection
 - Fuel injection pump timing to engine TDC

- Fuel injection pump type: Distributor type with four pistons
 CAVDPA4

- Air cleaner Dry-type air cleaner with secondary (safety) element

* With the engine run in (above 100 hours of operation) and at operating temperature (engine and transmission), measured by means of a dynamometer
 Permissible variation $\pm 5\%$

TECHDA-LB21005BE-010488

Specifications

ELECTRICAL SYSTEM

- Batteries	2 x 12 volts, 88 Ah
- Alternator with internal regulator	
- 3050 and 3350	14 volts, 55, 70 or 85 amps.
- 3650	14 volts, 85 amps.
- Starting motor	12 volts, 3.1 kW (4.2 hp)
- Battery terminal grounded	negative

SYNCHRONIZED TRANSMISSION

- Type	Synchronized transmission
- Gear selections	8 forward and 4 reverse
- Gear shifting	Two forward ranges and one reverse range; Synchronized forward and reverse shifting within range

HI-LO SHIFT UNIT

- Type	Hydraulic gear reduction unit which can be shifted under load with "wet" multiple disk clutch and brake packs.
- Travel speed decreases in each gear by	approx. 20 %
On tractors up to 30 km/h (18.5 mph)	
- Shifting the normal speeds	hydraulic
- Shifting the reduced speeds	preloaded Belleville springs
On tractors up to 40 km/h (25.0 mph)	
- Shifting the reduced speeds	hydraulic
- Shifting the normal speeds	preloaded Belleville springs

CREEPER TRANSMISSION

- Type	synchronized reduction gear
- Travel speed decreases in first and reverse range by approx.	79 %
Shifting of both ranges	mechanical, not under load

DIFFERENTIAL AND FINAL DRIVES

- Type of differential	spiral bevel gears
- Type of final drive	planetary reduction drive

DIFFERENTIAL LOCK

- Operation	hand or foot operated
- Disengaged	automatically as soon as traction has equalized

TECHDA-LB21005CE-010488

Specifications

PTO

<ul style="list-style-type: none"> - Type - PTO speeds at engine speed of: - 2070 rpm on 3050 and 3350 tractors - 2414 rpm on 3650 tractors, RG2 roll guard - 2178 rpm on 3650 tractors, SG2 cab - 2170 rpm on 3050 and 3350 tractors - 2407 rpm on 3650 tractors, RG2 roll guard - 2172 rpm on 3650 tractors, SG2 cab - PTO clutch - PTO brake 	<p>independent of transmission, can be engaged and disengaged under load</p> <p>540 rpm 540 rpm 540 rpm 1000 rpm 1000 rpm 1000 rpm interchangeable or hand shift</p> <p>hydraulically operated "wet" disk clutch hydraulically operated "wet" disk brake</p>
--	--

FRONT PTO

<ul style="list-style-type: none"> - Type - Control - PTO speed at an engine speed of: 2172 rpm (counterclockwise) and 2154 rpm (clockwise) - PTO clutch - PTO brake 	<p>independent of transmission, can be engaged and disengaged under load electrical/hydraulic solenoid switch</p> <p>1000 rpm</p> <p>hydraulically operated "wet" disk clutch hydraulically operated "wet" disk brake</p>
--	---

PTO SPEEDS

at engine speed	540 rpm shaft	1000 rpm shaft
3050 and 3350 tractors		
- 800 rpm	208 rpm	368 rpm
- 2070 rpm	540 rpm	954 rpm
- 2170 rpm	566 rpm	1000 rpm
- 2300 rpm	600 rpm	1059 rpm
- 2400 rpm	626 rpm	1106 rpm
3650 tractors with RG2 roll guard		
- 800 rpm	179 rpm	332 rpm
- 2300 rpm	514 rpm	955 rpm
- 2407 rpm	538 rpm	1000 rpm
- 2414 rpm	540 rpm	1003 rpm
- 2500 rpm	559 rpm	1038 rpm
3650 tractors with SG2 cab		
- 800 rpm	198 rpm	368 rpm
- 2172 rpm	538 rpm	1000 rpm
- 2178 rpm	540 rpm	1003 rpm
- 2300 rpm	570 rpm	1059 rpm
- 2400 rpm	595 rpm	1105 rpm

TECHDA-LB21005DE-010886

Specifications

FRONT WHEEL DRIVE

- Type engaged hydraulically under load with "wet" disk clutch
- Control electrical/hydraulic solenoid switch
- Drive engagement preloaded Belleville springs
- Drive disengagement hydraulic

HYDROSTATIC STEERING

- Type without mechanical linkage between steering valve and front wheels

FOOT BRAKES

- Rear wheel brakes self-adjusting, hydraulically operated "wet" disk brakes
- Four-wheel brake (universal jointed drive shaft brake) self-adjusting, hydraulically operated disk brake
- Four-wheel brake (electric controlled) automatic engagement of front wheel drive

HANDBRAKE

- Type mechanically operated band-type locking brake acting on the differential

HYDRAULIC SYSTEM

- Type closed, constant pressure system
- System pressure when pump pistons idle 19000 kPa (190 bar; 2760 psi)
- Operating pressure 17000 kPa (170 bar; 2470 psi)
- Hydraulic pump 4 or 8-piston pump with variable displacement

ROCKSHAFT

- Type with three-point hitch
- Regulation load control, depth control, load-and-depth control, float position via draft links (mechanical or electronic)
- Control

- FRONT HITCH controlled by selective control valve

- GROUND TRAVEL SPEEDS see Operator's Manual

TECHDA-LB21005DE-010488

Specifications

FRONT AND REAR WHEELS

– Tires, tread widths, tire pressures
and ballast weights see "Operator's Manual"

DIMENSIONS AND WEIGHTS see "Operator's Manual"

CAPACITIES

Fuel tank

– 3050 and 3350 tractors 121.0 liters (32.0 U.S. gal.)
– 3650 tractors 118.0 liters (31.1 U.S. gal.)
– Auxiliary tank 52.0 liters (13.7 U.S. gal.)

Cooling system

– without SG2 cab 17.0 liters (4.5 U.S. gal.)
– with SG2 cab 19.0 liters (5.0 U.S. gal.)

Engine crankcase

Initial filling 12.0 liters (3.1 U.S. gal.)
Crankcase with filter replacement 11.5 liters (3.0 U.S. gal.)

Transmission/hydraulic system (including oil reservoir and oil cooler)

– Initial filling:
– without front wheel drive 53.0 liters (14.0 U.S. gal.)
– with front wheel drive 56.0 liters (14.8 U.S. gal.)
– with front PTO 58.0 liters (15.3 U.S. gal.)
– Oil change with filter replacement
– without front wheel drive 50.0 liters (13.2 U.S. gal.)
– with front wheel drive 53.0 liters (14.0 U.S. gal.)
– with front PTO 55.0 liters (14.55 U.S. gal.)

Front wheel drive

– Front axle housing 7.0 liters (1.85 U.S. gal.)
– Wheel hub housing, each 0.75 liters (0.2 U.S. gal.)

Hydraulic operated clutch system 250 cm³ (8.75 fl.oz.)

Air conditioning system 1.8 kg (4 lb)

TECHDA-LB21005EE-010488

Specifications

STANDARD TORQUES FOR HARDWARE

Recommended torques in Nm and ft-lb
for hose and pipeline connections

A	B		C	
	Nm	ft-lb	Nm	ft-lb
3/8-24 UNF	7,5	5,5	8	6
7/16-20 UNF	10	7	12	9
1/2-20 UNF	12	9	15	11
9/16-18 UNF	15	11	25	18
3/4-16 UNF	25	20	45	35
7/8-14 UNF	40	30	60	45
1-1/16-12 UNC	60	45	100	75
1-3/16-12 UNC	70	50	120	90
1-5/16-12 UNC	80	60	140	105
1-5/8-12 UNC	110	80	190	140
1-7/8-12 UNC	150	110	220	160

L 110 192

A-Thread size

B-With O-rings

C-With cone

L110192-LB21005AE-010886

Specifications

**Recommended torques in Nm and ft-lb for
UNC and UNF cap screws**

A	10.9 C		12.9 D	
	Nm	ft-lb	Nm	ft-lb
1/4	15	10	20	15
5/16	30	20	40	30
3/8	50	35	70	50
7/16	80	55	110	80
1/2	120	85	170	120
9/16	180	130	240	175
5/8	230	170	320	240
3/4	400	300	580	425
7/8	600	445	930	685
1	910	670	1400	1030
1-1/8	1240	910	1980	1460
1-1/4	1700	1250	2800	2060

L 110 193

A-Head marking
(Identifying strength)
B-Thread O.D. (In.)

C-Tempered steel high strength
bolts and cap screws
D-Tempered steel extra high
strength bolts and cap screws

*NOTE: A variation of $\pm 10\%$ is permissible for all
torques indicated in this chart.*

Torque figures indicated above and in the specification sections of this manual are valid for non-greased or non-oiled threads and heads unless otherwise specified. Therefore, do not grease or oil bolts or cap screws unless otherwise specified in this manual.

L110193-LB21005AE-010886

Specifications

Recommended torques in Nm and ft-lb for metric cap screws

A	8.8 C		10.9 D		12.9 E	
	Nm	ft-lb	Nm	ft-lb	Nm	ft-lb
M5	7	5	9	6,5	10	8,5
M 6	10	8,5	15	10	20	15
M 8	30	20	40	30	40	30
M 10	50	35	80	60	90	70
M 12	100	75	140	100	160	120
M 14	160	120	210	155	260	190
M 16	240	175	350	260	400	300
M 20	480	355	650	480	780	575
M 24	820	605	1150	850	1350	995
M 30	1640	1210	2250	1660	2700	1990
M 36	2850	2110	4000	2950	4700	3465

L 110 194

A-Head marking (identifying strength)
 B-Thread O.D. (mm)
 C-Standard bolts and cap screws strength bolts and cap screws

D-Tempered steel high strength bolts and cap screws
 E-Tempered steel extra high strength bolts and cap screws

NOTE: A variation of $\pm 10\%$ is permissible for all torques indicated in this chart.

Torque figures indicated above and in the specification sections of this manual are valid for non-greased or non-oiled threads and heads unless otherwise specified. Therefore, do not grease or oil bolts or cap screws unless otherwise specified in this manual.

L110194-LB21005AE-010886

SPECIAL TOOLS

FKM 10 001

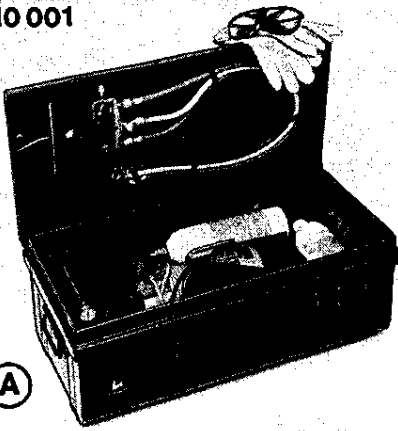

(A)

L 108053

- A-Checking refrigerant lines for leaks
- B-Turning engine for checking valve clearance
- C-Checking specified torques of cab mountings
- D-Checking tension of V-belts
- E-Checking TORX screws (with two-hole height adjustable trailer hitch)

JDE -83

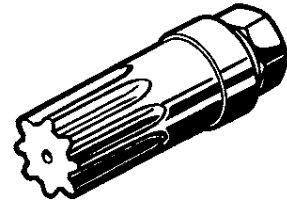

(B)

KJD 10138

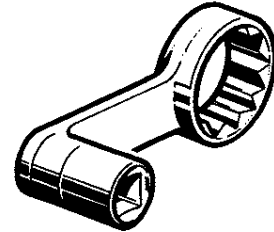

(C)

JDST-28

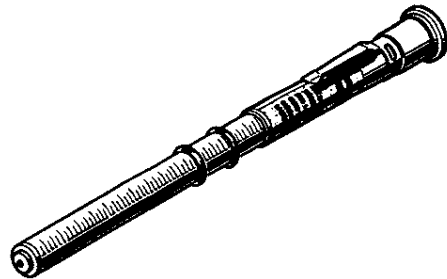

(D)

KJD10133

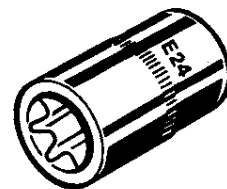

(E)

L 119368

L108053.L119368-LB21010AE-010488

SPECIFICATIONS

ENGINE SPEEDS

- Slow idle speed	750 to 850 rpm
- Fast idle speed:	
3050 and 3350 tractors	2410 to 2510 rpm
3650 tractors	2510 to 2610 rpm
- Rated engine speed	
- 3050 and 3350 tractors	2300 rpm
- 3650 tractors	2400 rpm

FAN BELT

Fan belt should have 19 mm (3/4 in.) flex with 90 N (20 lb) pull midway between crankshaft and alternator or water pump.

COMPRESSOR BELT

Compressor belt should have 19 mm (3/4 in.) flex with 60 N (13 lb) pull midway between both pulleys.

BATTERIES

Specific gravity at an acid temperature of 20° C (68° F)

- Normal and arctic conditions	1.28
- Tropical conditions	1.23

CLUTCH OPERATING LINKAGE

- Clutch pedal free travel (with mechanical operated clutch)	25 mm (1 in.)
--	---------------

FRONT WHEEL TOE-IN

- Tractors not equipped with front wheel drive	3 to 6 mm (1/8 to 1/4 in.)
- Tractors equipped with front wheel drive	0 to 3 mm (0 to 1/8 in.)

BRAKES

- To check brake setting, load each brake pedal for 1 minute with	270 N (60 lb)
- Lowering of a brake pedal within 1 minute at a load of 270 N (60 lb) max	approx. 25 mm (1 in.)
- Handbrake lever setting (third or fourth notch)	110 N (25 lb)

INSPEK-LB21010AE-010488

CAPACITIES

Engine crankcase	
- with filter change	11.5 liters (3.0 U.S. gal.)
Front wheel drive	
- Front axle housing	7.0 liters (1.85 U.S. gal.)
- Wheel hub housings, each	0.75 liters (0.2 U.S. gal.)

INSPEK-LB21010BE-010488

TORQUES FOR HARDWARE

Steel disk to front wheel hub	
- without front wheel drive	
(wheel bolts with cone)	150 Nm (110 ft-lb)
- without front wheel drive	
(wheel bolts without cone)	240 Nm (175 ft-lb)
- with front wheel drive	300 Nm (220 ft-lb)
Steel disk to front wheel rim	
- Attaching bolts M16 x 120	250 Nm (185 ft-lb)
- Attaching bolts M16 x 74	280 Nm (210 ft-lb)
On tractors with flanged rear axle	
- Rear wheels to rear axle	400 Nm (300 ft-lb)
- Steel disk to rear wheel rim,	
attaching bolts M16 x 120	250 Nm (185 ft-lb)
- Steel disk to rear wheel rim,	
attaching bolts M16 x 74	280 Nm (210 ft-lb)
- Cast disk to rear wheel rim	230 Nm (170 ft-lb)
On tractors with rack-and-pinion axle	
- Rear wheel rim to wheel hub	
- Steel type	400 Nm (300 ft-lb)
- Cast type	230 Nm (170 ft-lb)
- Pinion sleeve half to wheel hub	215 Nm (160 ft-lb)
- Key sleeve half to wheel hub	400 Nm (300 ft-lb)
Axle arms to front axle center	400 Nm (300 ft-lb)
Tie rod clamps,	
- M10 cap screw	55 Nm (40 ft-lb)
- M12 cap screw	90 Nm (65 ft-lb)
Tie rod tube, cap screw	55 Nm (40 ft-lb)

INSPEK-LB21010CE-010488

TORQUES FOR HARDWARE (CONTD.)

SG2 cab or RG2 roll guard rubber mounting blocks	
– Cap screws and hex. nuts	200 Nm (145 ft-lb)
4-post roll guard to fenders, cap screws	120 Nm (85 ft-lb)
2-post roll guard	
– Support to final drives, cap screws	400 Nm (300 ft-lb)
– Crossmember to support, cap screws	230 Nm (170 ft-lb)
“Axla” trailer hitch	
Earlier type	
– Hex. socket screws	160 Nm (120 ft-lb)
– Cap screws	230 Nm (170 ft-lb)
– Hex. nuts	335 Nm (245 ft-lb)
Later type	
Console cap screws	
– Transmission case, front	320 Nm (235 ft-lb)
– Transmission case, rear	160 Nm (120 ft-lb)
Trailer hitch cap screws – 5/8 in.	320 Nm (235 ft-lb)
Trailer hitch cap screws – 1/2 in.	120 Nm (85 ft-lb)
Two-hole height adjustable trailer hitch TORX screws	
– Hitch bracket, center vertical	100 Nm (75 ft-lb) + 45°
– Hitch bracket, upper left and right	100 Nm (75 ft-lb) + 72°
– Hitch bracket, lower left and right	100 Nm (75 ft-lb) + 90°
Eight-hole height adjustable trailer hitch	
Guide rails, hex. nuts	500 Nm (370 ft-lb)

PREDELIVERY INSPECTION

NOTE: Should a malfunction occur when carrying out the predelivery inspection, then see relevant T.M. "Engines" or "Operation and Tests".

INSPEK-LB21010JE-010488

CHECKING FUEL LINES FOR LEAKS

A-Tractors with auxiliary fuel tank
B-Tractors without auxiliary fuel tank

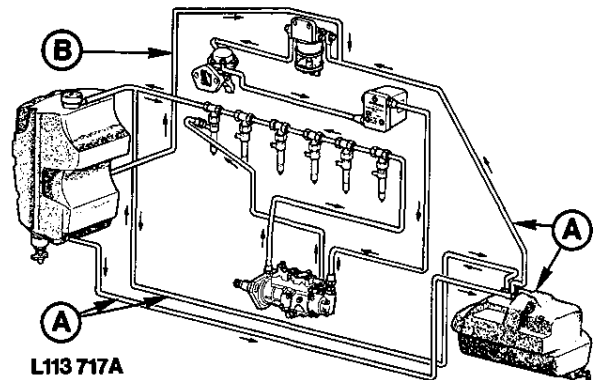

L113717A-LB21010AE-010488

EXAMINING ENGINE FOR LEAKS

INSPEK-LB21010EE-010886

CHECKING OIL LEVEL IN ENGINE CRANKCASE

If necessary, add oil to bring oil level to top mark on dipstick. Use JOHN DEERE TORQ-GARD Supreme engine oil SAE 10W-20 or an equivalent oil (see Group 15).

A-Oil dipstick
B-Oil filler neck

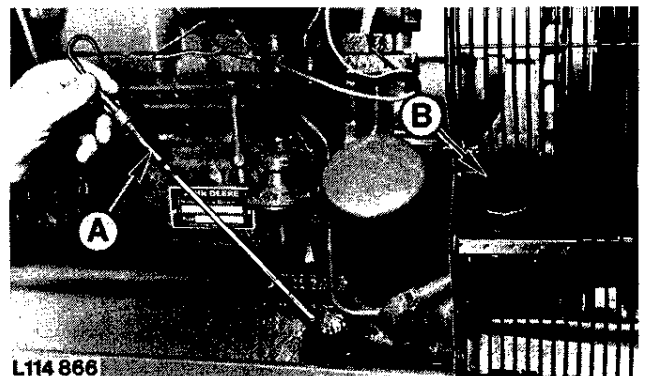

L114866-LB21010AE-010488

CHECKING COOLANT LEVEL

Coolant must reach up to marking plate in radiator.

JOHN DEERE engine cooling fluid is filled into the cooling system at the factory. It protects the engine against corrosion and against frost down to -36°C (-35°F).

IMPORTANT: Use only JOHN DEERE engine cooling fluid in the cooling system, independent of the season.

If no JOHN DEERE engine cooling fluid is available, use a mixture of 50% ethylene-glycol antifreeze/corrosion inhibitor and 50% clear, soft water. This guarantees engine protection against corrosion and frost down to -36°C (-35°F).

Never use any cooling system sealing additives.

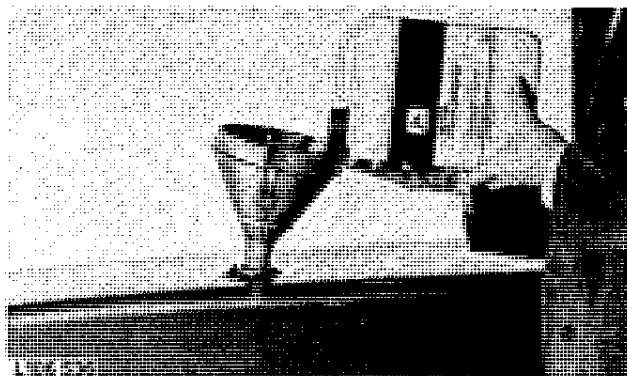
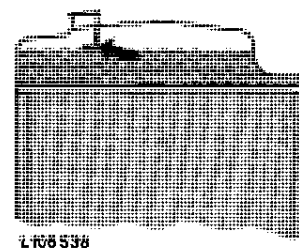
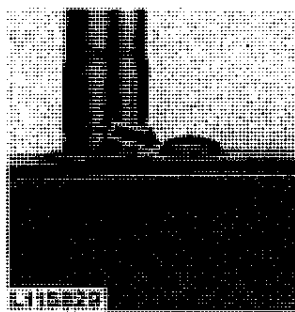

L115829,L106536,L106536-LB21010AE-010488

CHECKING ENGINE IDLE SPEEDS

3050 and 3350 Tractors

Warm up engine to operating temperature and check speeds.

Slow idle speed: 750 to 850 rpm

Fast idle speed: 2410 to 2510 rpm

See Section 30, Group 15, for adjustment.

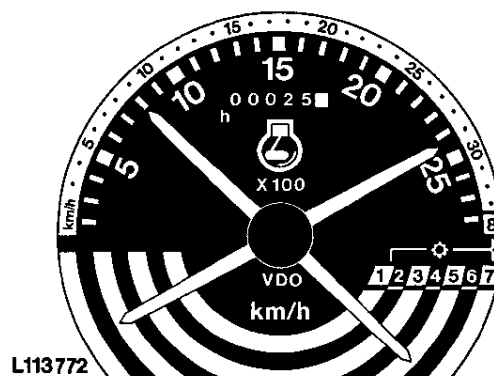

L113772-LB21010AE-010488

3650 Tractors

Warm up engine to operating temperature and check speeds.

Slow idle speed: 750 to 850 rpm

Fast idle speed: 2510 to 2610 rpm

See Section 30, Group 15, for adjustment.

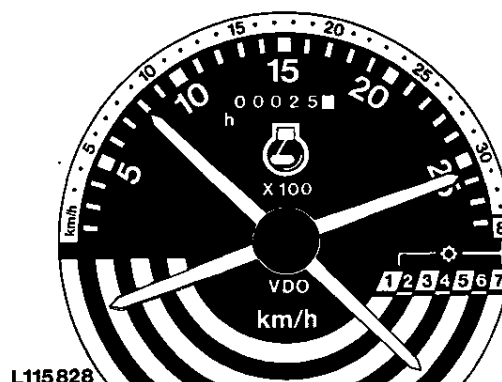

L115828-LB21010AE-010488

CHECKING FUNCTION OF ENGINE SHUT-OFF CABLE

Run engine at slow idle speed for 1 to 2 minutes.

Completely pull out shut-off knob (A), making sure engine stops immediately. Switch off main switch (B).

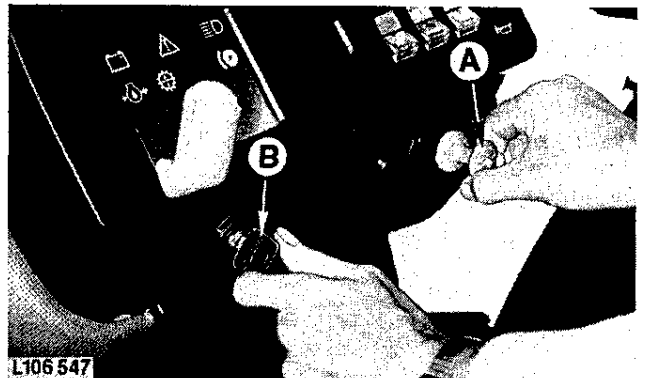

L106547

L106547-LB21010AE-010488

CHECKING AIR CLEANER AND SAFETY ELEMENTS FOR CORRECT INSTALLATION

Make sure that dust unloading valve (C) (rubber cap) is installed on air cleaner.

- A-Air cleaner element
- B-Safety element
- C-Dust unloading valve

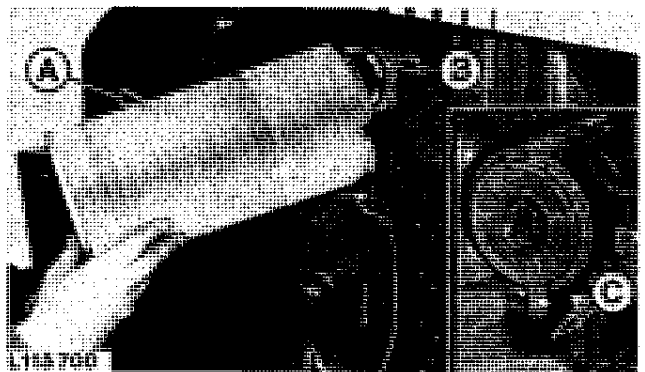

L115700

L115700-LB21010AE-010488

CHECKING HOSE CLAMPS OF AIR INTAKE SYSTEM FOR TIGHTNESS



L113770

L113770-LB21010AE-010886

INSTALLING EXHAUST STACK

Up To Tractor Serial No. 629 372L

Install weather flap with flap hinge at the rear (as seen in direction of forward travel).

Distance (A) between cap and stack end must be 2 mm (5/64 in.).

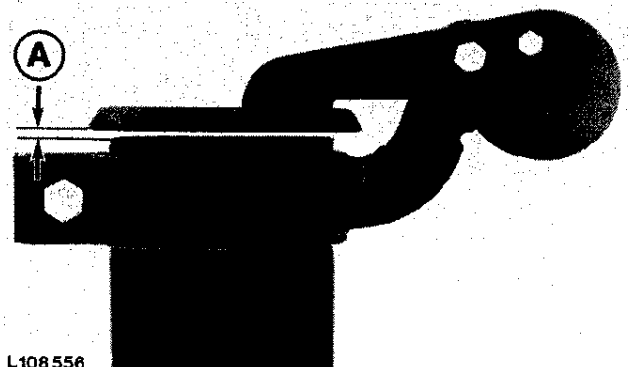

L108556

L108556-LB21010AE-010488

From Tractor Serial No. 629 373L

With SG2 Cab: install exhaust stack with opening facing to the rear of tractor.

With Low Profile SG2 Cab or Without Cab: Install exhaust stack with opening facing to the left.

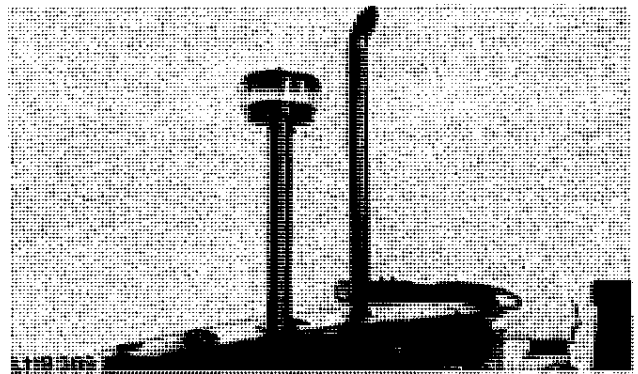

L119369-LB21010AE-010488

CHECKING FAN BELT TENSION

Using belt tension gauge JDST-28 (C) check tension of fan belt.

Fan belt should have 19 mm (3/4 in.) flex with 90 N (20 lb) pull midway between crankshaft and alternator.

- A-Fan belt
- B-Attaching nut
- C-Belt tension gauge (JDST-28)

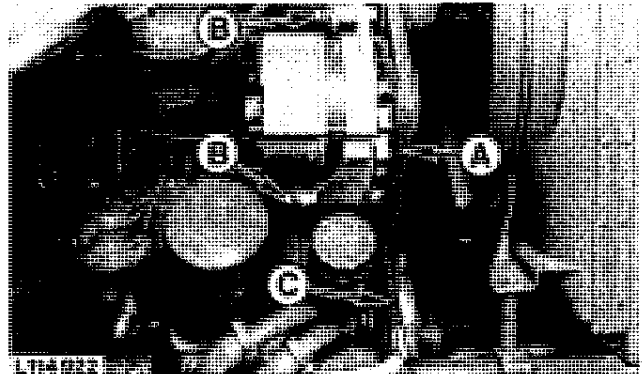

L114922-LB21010AE-010686

**CHECKING COMPRESSOR BELT TENSION
(Tractors with Air Conditioning System)**

Using belt tension gauge JDST-28 (A) check compressor belt tension.

Compressor belt should have 19 mm (3/4 in.) flex with 60 N (13 lb) pull midway between both pulleys.

- A-Belt tension gauge (JDST-28)
- B-Adjusting screw
- C-Compressor belt

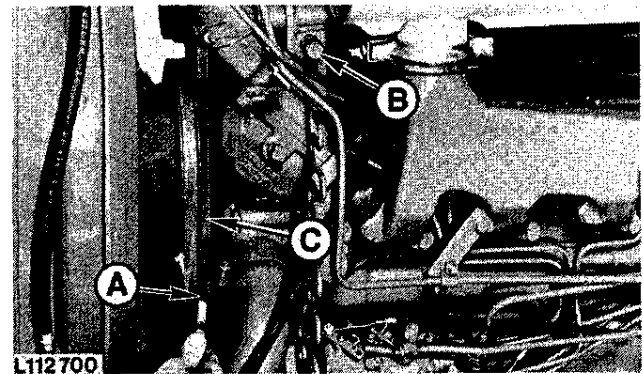

L112700-LB21010AE-010886



Suggest:

If the above button click is invalid.

Please download this document

first, and then click the above link

to download the complete manual.

Thank you so much for reading

IMPORTANT NOTES

If the engine is to be run for a short time without battery (using a slave battery for starting), do not, under any circumstances, interrupt this circuit by switching off the main switch before stopping the engine by means of the fuel pump shut-off cable. An additional load (lights) must also be switched on. Do not run engine above 1000 rpm. Insulate battery end of disconnected starter cable properly to avoid damage to alternator and regulator.

Do NOT connect ground strap of slave battery to frame on tractors equipped with an SG2 cab or RG2 roll guard.

Observe proper polarity when connecting batteries and chargers. Improperly connected batteries ("+" and "-") result in immediate destruction of rectifier diodes.

A-Positive terminals
B-Negative terminals

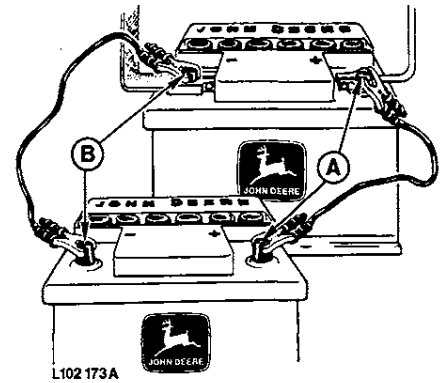

L102173A-LB21010AE-010886

CHECKING BATTERIES

Check battery terminals and cable ends and, if necessary, clean and coat them with petroleum jelly.

Check electrolyte level in each battery cell. If necessary, add distilled water to bring level above cell plates.

A-Filler caps

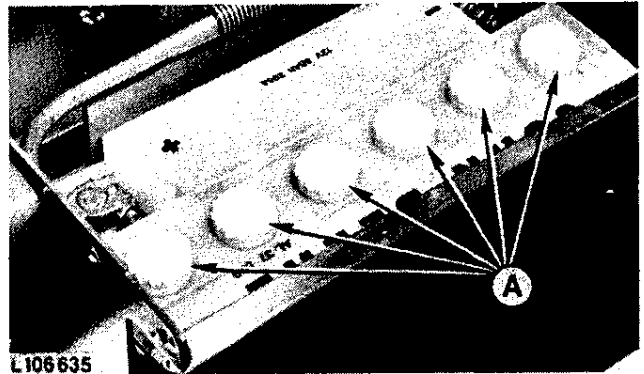

L106635-LA71010AE-091184

CHECKING START SAFETY SWITCH

Operate starter switch (B).

NOTE: Starting motor should turn only with the range shift lever (A) in neutral position.

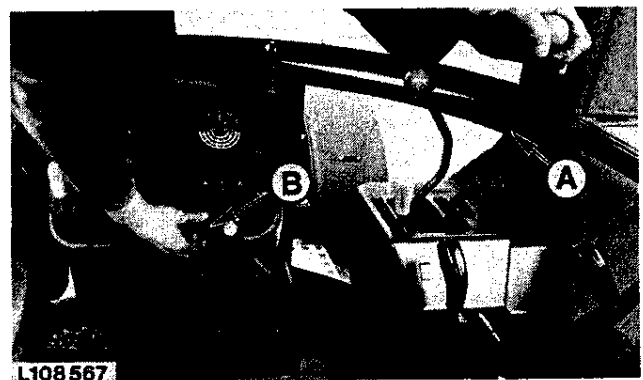

L108567-LB21010AE-010488

<https://www.ebooklibonline.com>

Hello dear friend!

Thank you very much for reading.

Enter the link into your browser.

The full manual is available for immediate download.

<https://www.ebooklibonline.com>