

# 2350 and 2550 Tractors



JOHN DEERE

## TECHNICAL MANUAL 2350 and 2550 Tractors

TM4403 (01MAY85) English

**TM4403 (01MAY85)**

LITHO IN U.S.A.  
ENGLISH



# 2350 AND 2550 TRACTORS TECHNICAL MANUAL TM-4403 (May-85)

## CONTENTS

### SECTION 10 - GENERAL

- Group 00 - Specifications and Special Tools
- Group 05 - Predelivery, Delivery and After-Sales Inspections
- Group 10 - Lubrication and Periodic Service
- Group 15 - Engine and Tractor Tune-Up
- Group 20 - Tractor Separation

### SECTION 20 - ENGINE

- Group 00 - Specifications and Special Tools
- Group 05 - General Information Diagnosing Malfunctions
- Group 10 - Cylinder Head, Valves, Camshaft and Balancer Shafts
- Group 15 - Cylinder Block, Liners, Pistons and Connecting Rods
- Group 20 - Crankshaft, Main Bearings and Flywheel
- Group 25 - Timing Gear Train
- Group 30 - Engine Lubrication System
- Group 35 - Cooling System

### SECTION 30 - FUEL AND AIR INTAKE SYSTEM

- Group 00 - Specifications and Special Tools
- Group 05 - General Information, Diagnosing Malfunctions
- Group 10 - Fuel Tank, Water Trap, Fuel Transfer Pumps and Fuel Filter
- Group 15 - Roto Diesel Fuel Injection Pump
- Group 20 - Fuel Injection Nozzles
- Group 25 - Cold Weather Starting Aids
- Group 30 - Speed Control Linkage
- Group 35 - Air Cleaner

### SECTION 40 - ELECTRICAL SYSTEM

- Group 00 - Specifications and Special Tools
- Group 05 - Description, Diagnosing Malfunctions and Tests
- Group 10 - Wiring Harnesses
- Group 15 - Controls and Instruments
- Group 20 - Lighting Systems
- Group 25 - Wiring Diagrams
- Group 30 - Starting Motor
- Group 35 - Alternator

All information, illustrations and specifications contained in this technical manual are based on the latest information available at the time of publication. The right is reserved to make changes at any time without notice.

COPYRIGHT® 1985  
DEERE & COMPANY  
Moline, Illinois  
All rights reserved  
Previous Edition  
Copyright® 1982  
Copyright® 1984  
DEERE & COMPANY

---

## CONTENTS

### SECTION 50 - POWER TRAIN

- Group 00 - Specifications and Special Tools
- Group 05 - Description, Operation and Lubricating System
- Group 10 - Clutch Operating Linkages
- Group 15 - Engine Clutch
- Group 20 - Hi-Lo Shift Unit
- Group 21 - Reverser Transmission
- Group 22 - Creeper Transmission
- Group 25 - Transmission Shift Linkages
- Group 30 - Synchronized Transmission and Transmission Oil Pump
- Group 31 - Collarshift Transmission and Transmission Oil Pump
- Group 35 - Differential
- Group 40 - Final Drives
- Group 45 - Independent PTO
- Group 46 - Continuous - Running PTO
- Group 50 - Mechanical Front Wheel Drive

### SECTION 60 - STEERING SYSTEM AND BRAKES

- Group 00 - Specifications and Special Tools
- Group 05 - Steering
- Group 10 - Brakes

### SECTION 70 - HYDRAULIC SYSTEM

- Group 00 - Specifications and Special Tools
- Group 05 - Description, Diagnosing Malfunctions and Pressure Tests
- Group 10 - Oil Reservoir, Filter, Valves and Oil Cooler
- Group 15 - 22.6 cm<sup>3</sup> (1.38 cu. in.) Hydraulic Pump
- Group 16 - 40.0 cm<sup>3</sup> (2.40 cu. in.) Hydraulic Pump
- Group 20 - Rockshaft
- Group 25 - Selective Control Valve (Poppet Valve Type) and Breakaway Coupler
- Group 26 - Selective Control Valves (Spool Type)
- Group 30 - Remote Cylinder

### SECTION 80 - MISCELLANEOUS

- Group 00 - Specifications
- Group 05 - Front Axle
- Group 10 - Front and Rear Wheels

### SECTION 90 - OPERATOR'S STATION

- Group 00 - Specifications and Special Tools
- Group 05 - Air Conditioning System
- Group 10 - Cab Ventilation and Heating
- Group 15 - Seats
- Group 20 - SOUND-GARD Body
- Group 25 - ROLL-GARD Protective Structure

**<https://www.ebooklibonline.com>**

Hello dear friend!

Thank you very much for reading.

Enter the link into your browser.

The full manual is available for immediate download.

**<https://www.ebooklibonline.com>**

# Section 10 GENERAL

## CONTENTS OF THIS SECTION

	Page		Page
<b>GROUP 00 - SPECIFICATIONS AND SPECIAL TOOLS</b>		<b>GROUP 05 - PREDELIVERY, DELIVERY AND AFTER-SALES INSPECTIONS</b>	
Specifications .....	10-00-3	Tractor Storage .....	10-05-1
Serial Numbers .....	10-00-3	Predelivery Inspection .....	10-05-2
Model Numbers .....	10-00-3	Delivery Inspection .....	10-05-9
Engine .....	10-00-3	After-Sales Inspection .....	10-05-10
Engine Clutch .....	10-00-4	<b>GROUP 10 - LUBRICATION AND SERVICE</b>	
Cooling System .....	10-00-4	Lubrication and Service .....	10-10-1
Fuel System .....	10-00-4	<b>GROUP 15 - TUNE-UP</b>	
Electrical System .....	10-00-5	Preliminary Engine Testing .....	10-15-1
Synchronized Transmission .....	10-00-5	Dynamometer Test .....	10-15-1
Collar Shift Transmission .....	10-00-5	Testing Compression Pressure .....	10-15-2
Hi-Lo Shift Unit .....	10-00-5	Engine Tune-Up .....	10-15-3
Reverser Transmission .....	10-00-5	Checking Tractor Operation .....	10-15-8
Creep Transmission .....	10-00-6	Standard Torques .....	10-15-9
Differential and Final Drives .....	10-00-6	<b>GROUP 20 - TRACTOR SEPARATION</b>	
Differential Lock .....	10-00-6	Separating Between Engine and	
PTO .....	10-00-6	Tractor Front End .....	10-20-1
Mechanical Front Wheel Drive .....	10-00-7	Removal and Installation of Engine .....	10-20-5
Hydrostatic Steering .....	10-00-7	Removal and Installation of	
Foot Brakes .....	10-00-7	Clutch Housing .....	10-20-9
Handbrake .....	10-00-7	Removal and Installation of	
Hydraulic System .....	10-00-7	Final Drives .....	10-20-13
Capacities .....	10-00-7	Removal and Installation of	
Travel Speeds .....	10-00-8	Rockshaft .....	10-20-18
Front and Rear Wheels .....	10-00-8	Removal and Installation of	
Dimensions and Weights .....	10-00-8	SOUND-GARD® Body .....	10-20-20
Predelivery, Delivery and			
After-Sales Inspections .....	10-00-8		
Lubrication and Service .....	10-00-9		
Tune-Up .....	10-00-11		
Tractor Separation .....	10-00-12		
Standard Torques .....	10-00-13		
Special Tools .....	10-00-15		



**Group 00**

**SPECIFICATIONS AND SPECIAL TOOLS**

**SPECIFICATIONS**

**SERIAL NUMBERS**

The engine serial number is stamped into the plate located on the lower front right-hand side of the cylinder block.

*NOTE: When ordering engine parts, quote all digits of serial number stamped on the plate.*

The plate showing the tractor serial number is located on the right-hand side of the front axle carrier.

*NOTE: When ordering tractor spare parts (excluding engine parts), quote all digits and letters of serial number stamped on the plate.*

A plate showing the tractor type, transmission serial number, cone point measurement etched into pinion face of differential drive shaft as well as reduction of differential is located on the right-hand side of the transmission case.

**MODEL NUMBERS**

The fuel injection pump, fuel injection nozzles, alternator, starting motor, hydrostatic steering valve, compressor of air conditioning system (when equipped) and hydraulic pump have model numbers to facilitate identification of different makes of a given unit.

**ENGINE**

Number of cylinders .....		4
Cylinder liner bore .....	106.5 mm	4.19 in.
Stroke .....	110 mm	4.33 in.
Displacement .....	3920 cm <sup>3</sup>	239 cu. in.
Compression ratio .....		16.8 : 1
2350 up to engine serial no. 571 490 CD and 2550 up to engine serial no. 547 536 CD .....		16.8:1
2350 from engine serial no. 571 491 CD and 2550 from engine serial no. 547 537 CD .....		17.4:1
<b>Maximum torque</b>		
2350 at 1400 rpm .....	220 N·m	160 lb-ft
2550 at 1400 rpm .....	250 N·m	185 lb-ft
Firing order .....		1 - 3 - 4 - 2
<b>Valve clearance (engine hot or cold)</b>		
Intake valve .....	0.35 mm	0.014 in.
Exhaust valve .....	0.45 mm	0.018 in.

Fast idle speed .....	2670 to 2660 rpm
Slow idle speed .....	700 to 800 rpm
Rated engine speed .....	2500 rpm
Working speed range 2350 and 2550 .....	1400 to 2500 rpm
PTO* horsepower at engine rated speed—2550 rpm	
According to SAE J816b—2350 .....	41 kW                      55 hp
2550 .....	48 kW                      65 hp

Lubrication system ..... Full internal force feed system with full flow filter

**ENGINE CLUTCH** ..... Single dry disk clutch with torsion damper, foot operated

**COOLING SYSTEM**

Type ..... Pressurized system with centrifugal pump

Temperature regulation ..... Thermostat

**FUEL SYSTEM**

Type ..... Direct injection

Fuel injection pump timing to engine ..... TDC

Fuel injection pump type ..... Distributor type

2350 .....	Roto Diesel No. R 3448F040
2550 up to engine serial no. 573009CD .....	Roto Diesel No. R 3443F950
2550 from engine serial no. 573010CD .....	Roto Diesel No. R 3448F230

Air cleaner ..... Dry-type air cleaner with secondary  
(safety) element

*\*With the engine run in (above 100 hours of operation) and having reached operating temperature (engine and transmission); measured by means of a dynamometer. Permissible variation ± 5 per cent.*

**Electrical System**

- Batteries ..... 2 x 12 volts, 55 Ah or 66 Ah
- Alternator with internal regulator
  - Tractors without SOUND-GARD body ..... 14 volts, 33 or 55 amps.
  - Tractors with SOUND-GARD body ..... 14 volts, 55 amps.
- Starting motor ..... 12 volts, 3 kW (4 hp)
- Battery terminal grounded ..... negative

**Synchronized Transmission**

- Type ..... Synchronized transmission
- Gear selections ..... 8 forward and 4 reverse
- Gear shifting ..... Two forward groups and one reverse group  
Synchronized forward and reverse  
shifting within groups

**Collar Shift Transmission**

- Type ..... Helical gears
- Gear selections ..... 8 forward, 4 reverse speeds
- Gear shifting ..... Two forward ranges, One reverse range

**Hi-Lo Shift Unit**

- Type ..... Hydraulic gear reduction unit which can be  
shifted under load with "wet" multi-  
ple disk clutch and brake packs
- Travel speed decreases in each gear by ..... Approx. 20 per cent
- Shifting to reduced (Lo) speed ..... Preloaded cup springs
- Shifting to normal (Hi) speed ..... Hydraulic

**Reverser Transmission**

- Type ..... Hydraulically controlled can be  
shifted under load, with "wet" disk  
clutches and brakes, planetary reverser unit
- Gear selections ..... 1 to 4
- Increase in reverse gear speeds ..... Approx. 16 per cent.

**Creep Transmission**

Type ..... Synchronized reduction unit  
 Travel speed decreases in low (l) and reverse ranges by ..... approx. 79%  
 Shifting both ranges ..... Mechanical and not under load

**Differential and Final Drives**

Type of differential ..... Spiral bevel gears  
 Type of final drive ..... Planetary reduction drive

**Differential Lock**

Operation ..... Hand or foot operated  
 Disengage ..... Will disengage automatically as soon as traction has equalized

**PTO**

**INDEPENDENT PTO - 540 rpm or 540/1000 rpm**

Type ..... Independent of transmission, can be engaged and disengaged under load  
 PTO clutch ..... Hydraulically operated "wet" disk clutch  
 PTO brake ..... Hydraulically operated "wet" disk brake

**CONTINUOUS - RUNNING PTO - 540 rpm**

Type ..... Independent of transmission, with engine dual-stage clutch

**PTO SPEEDS (IN RPM)—WITHOUT REVERSER**

Engine speed	540 rpm shaft	1000 rpm shaft
800	180	335
2400	540	1000
2500	565	1040
2660	600	1110

**PTO SPEEDS (IN RPM)—WITH REVERSER**

Engine speed	540 rpm shaft
800	210
2075	540
2400	625
2500	650
2660	690

**Mechanical Front Wheel Drive**

Type ..... Engaged hydraulically, under full load with "wet" disk clutch

Control ..... Electrical/hydraulic solenoid switch

Engagement ..... Preloaded cup springs

Disengagement ..... Hydraulic

**Hydrostatic Steering** ..... Without mechanical linkage between steering valve and the front wheels

**Foot Brakes** ..... 1 Self-adjusting, hydraulically operated "wet" disk brakes

**Handbrakes** ..... Mechanically operated band-type locking brake acting on the differential

**Hydraulic System**

Type ..... Closed center, constant pressure system

Standby pressure ..... 15800 to 16200      158 to 162 bar      2300 to 2350 psi

Operating pressure ..... 14000 kPa      140 bar      2050 psi

Hydraulic pump ..... 8-piston pump with variable displacement

**Capacities**

Fuel tank ..... 91 L      24.0 U.S. gal

## Cooling System

Without SOUND-GARD body ..... 13 L      3.4 U.S. gal

With SOUND-GARD body ..... 14 L      4.0 U.S. gal

## Engine crankcase

Without filter change ..... 8 L      2.1 U.S. gal

With filter change ..... 8.5 L      2.25 U.S. gal

## Transmission - Hydraulic system (including oil reservoir and oil cooler)

## Synchronized transmission

Dry system—2350 ..... 59 L      15.6 U.S. gal

2550 ..... 64 L      16.9 U.S. gal

Oil change—2350 ..... 51 L      13.5 U.S. gal

2550 ..... 56 L      14.8 U.S. gal

## Collar shift transmission (with reverser)

Dry system ..... 42 L      11.1 U.S. gal

Oil change ..... 34 L      9.0 U.S. gal

**Capacities (Contd.)**

Oil reservoir .....	4 L	1.1 U.S. gal
Oil cooler .....	2 L	0.5 U.S. gal

**Mechanical front wheel drive**

Front axle housing .....	5.0 L	(1.30 U.S. gal)
Wheel hub, each .....	0.75 L	(0.2 U.S. gal)

**Travel Speeds** ..... see Operator's Manual

**Front and Rear Wheels**

tires, tread widths, tire pressures and ballast weights ..... see Operator's Manual

**Dimensions and Weights** ..... see Operator's Manual

**Predelivery, Delivery and After-Sales Inspections****ENGINE SPEEDS**

Slow idle .....	700 to 800 rpm
Fast idle .....	2610 to 2660 rpm
Rated speed .....	2500 rpm

**FAN BELT**

The fan belt should have 19 mm (3/4 in.) flex with 90 N (20 lb force) pull midway between crankshaft and alternator or water pump (use a spring scale).

**COMPRESSOR BELT**

The compressor belt should have 19 mm (3/4 i.) flex with 60 N (13 lb force) pull midway between pulleys.

**BATTERIES**

Specific gravity at an electrolyte temperature of 20°C (68°F)

Normal and arctic conditions .....	1.28
Tropical conditions .....	1.23

**Clutch Operating Linkage****Tractors without SOUND-GARD Body**

Clutch pedal free travel ..... 25 mm approx. (1 in.)

**Tractors with SOUND-GARD Body**

Travel of slave cylinder operating rod ..... 8.5 to 12 mm  
5/16 to 15/32 in.

**Front Wheel Toe-In**

Tractors without MFWD .....	3 to 6 mm	(0.12 to 0.25 in.)
Tractors with MFWD .....	0 to 3 mm	(0 to 0.12 in.)

**Torques for Hardware**

Start safety switch in rockshaft housing, max. ....	50 N·m	(35 lb-ft)
Front wheel rim to hub		
Tractors without MFWD .....	180 N·m	(130 lb-ft)
Tractors with MFWD .....	300 N·m	(220 lb-ft)
Axle knees to axle center, cap screws .....	400 N·m	(300 lb-ft)
Tie rod clamps		
Cap screw (M10) .....	55 N·m	(40 lb-ft)
Cap screw (M13) .....	90 N·m	(65 lb-ft)
Tie rod tube, cap screw .....	55 N·m	(40 lb-ft)
Rear wheels to axle .....	400 N·m	(300 lb-ft)
Wheel disk to hub (rack-and-pinion axle) .....	400 N·m	(300 lb-ft)
2-post ROLL-GARD protective structure		
Supports to crossbar, cap screws .....	230 N·m	(170 lb-ft)
Supports to final drives, cap screws and nuts .....	230 N·m	(170 lb-ft)

**LUBRICATION AND SERVICE**

Capacities

Engine crankcase

Without filter change .....	8.0 L	(2.1 U.S. gal)
With filter change .....	8.5 L	(2.3 U.S. gal)

Cooling System

Without SOUND-GARD body .....	13 L	(3.4 U.S. gal)
With SOUND-GARD body .....	15 L	(4.0 U.S. gal)

Transmission - Hydraulic system (including oil reservoir and oil cooler)

Synchronized transmission

Dry system - 2350 .....	59 L	15.6 U.S. gal
2550 .....	64 L	16.9 U.S. gal
Oil change - 2350 .....	51 L	13.5 U.S. gal
2550 .....	56 L	14.8 U.S. gal

Collar shift transmission (with reverser)

Dry system .....	42 L	11.1 U.S. gal
Oil change .....	34 L	9.0 U.S. gal

**Capacities (Contd.)**

Oil reservoir .....	4 L	1.1 U.S. gal
Oil cooler .....	2 L	0.5 U.S. gal

## Mechanical front wheel drive

Front axle housing .....	5.0 L	(1.30 U.S. gal)
Wheel hub, each .....	0.75 L	(0.2 U.S. gal)

**Service Intervals**

Checking crankcase oil level .....	every 10 hours
Changing engine oil .....	every 100 hours
Changing engine oil filter .....	every 200 hours
Checking transmission/hydraulic system oil level .....	every 50 hours
Changing transmission/hydraulic system oil filter .....	every 500 hours
Changing transmission/hydraulic oil .....	every 1000 hours
Changing hydrostatic steering filter .....	every 100 hours
Cleaning hydraulic pump strainer .....	every 1000 hours
Checking MFWD oil level .....	every 100 hours
MFWD oil change .....	every 1000 hours
Cleaning and packing front wheel bearings .....	every 1000 hours
Lubricating grease fittings	
Clutch throw-out bearing grease fitting (when equipped) .....	every 100 hours
Mechanical front wheel drive universal-jointed shaft .....	every 50 hours
in wet and muddy conditions .....	every 10 hours
Front axle and front axle bearings .....	every 50 hours
in wet and muddy conditions .....	every 10 hours
Rear axle bearings .....	every 500 hours
in wet and muddy conditions .....	every 10 hours
Three-point hitch .....	every 200 hours

## Tune-Up

PTO horsepower\* at 2500 rpm rated engine speed

According to SAE J816b,	2350	4 kW	55 hp
	2550	48 kW	65 hp
Compression	2100 kPa	21 bar	300 psi
Slow idle	700 to 800 rpm		
Fast idle	2610 to 2660 rpm		
Rated engine speed	2500 rpm		
Air intake system vacuum	3.5 to 6.0 kPa	35 to 60 mbar	14 to 25 in. water head
Air cleaner restriction warning switch closes at a vacuum of	5.5 to 6.5 kPa	55 to 65 mbar	22 to 26 in. water head
Blow-by at crankcase vent tube, max			
2350		2.5 m <sup>3</sup> /h	88 cu ft/h
2550		2.7 m <sup>3</sup> /h	95 cu ft/h
Thermostat open at		82°C	180°F
Radiator cap high pressure valve opens at	40 to 50 kPa	0.4 to 0.5 bar	6 to 7 psi
Radiator cap low pressure valve opens at	0 to 4 kPa	0 to 0.04 bar	0 to 0.6 psi

## Fan Belt

Fan belt should have 19 mm (3/4 in.) flex with 90 N (20 lb force) pull midway between crankshaft and alternator or water pump (use a spring scale).

## Compressor Belt

Compressor belt should have 19 mm (3/4 in.) flex with 60 N (13 lb force) pull midway between pulleys.

*\*With the engine run in (more than 100 hours of operation) and having reached operating temperature (engine and transmission); measured by means of a dynamometer. Permissible variation + 5 per cent.*

**TRACTOR SEPARATION****Torques for Hardware**

Front axle carrier to engine block		
front attaching cap screws (4 used) .....	230 N·m	170 lb-ft
rear attaching cap screws (2 used) .....	180 N·m	130 lb-ft
Front axle carrier to oil pan, cap screws .....	400 N·m	300 lb-ft
Hydraulic pump drive shaft, cap screws .....	50 N·m	35 lb-ft
Jointed shaft flange to front axle		
drive hub (tractors with MFWD), cap screws .....	75 N·m	55 lb-ft
Clutch housing to engine block		
Cap screws .....	230 N·m	170 lb-ft
Hex. nuts .....	230 N·m	170 lb-ft
Oil pan to clutch housing, cap screws .....	230 N·m	170 lb-ft
Clutch housing to transmission case, cap screws .....	160 N·m	120 lb-ft
Transmission case drain plugs .....	135 N·m	100 lb-ft
Hydraulic lines retainer to		
clutch housing, cap screw .....	45 N·m	32 lb-ft
Final drive housings to transmission case, cap screws .....	120 N·m	85 lb-ft
Rockshaft housing to transmission case, cap screws .....	120 N·m	85 lb-ft
Rear wheels to rear axle .....	400 N·m	300 lb-ft
Wheel disk to hub (on tractors equipped		
with rack-and-pinion axle) .....	400 N·m	300 lb-ft
Rear fenders to final drive housings, hex. nuts .....	130 N·m	95 lb-ft
2-post roll guard to final drive housings .....	230 N·m	170 lb-ft
both supports to crossbar .....	230 N·m	170 lb-ft
Basic weight to front axle carrier, cap screws .....	400 N·m	300 lb-ft
Drawbar to transmission case, cap screws .....	120 N·m	85 lb-ft
SOUND-GARD Body to rubber bearing blocks,		
cap screws and hex. nuts .....	200 N·m	145 lb-ft

## ENGLISH TORQUE SPECIFICATIONS

*NOTE: Wrench torque tolerance is  $\pm 20\%$ .*

Bolt Diameter	Plain Head*		Three Radial Dashes*		Six Radial Dashes*	
	lb-ft	N-m	lb-ft	N-m	lb-ft	N-m
1/4 in.	6	8	9	12	12	16
5/16 in.	10	14	18	24	25	34
3/8 in.	20	27	30	41	45	61
7/16 in.	30	41	50	68	70	95
1/2 in.	45	61	75	101	110	149
9/16	70	95	110	150	155	210
5/8 in.	95	128	155	210	215	290
3/4 in.	165	225	270	365	385	520
7/8 in.	170	230	435	590	620	840
1 in.	255	345	660	895	930	1260

Torque figures indicated above and in the Specification Sections of this manual are valid for non-greased or non-oiled threads and heads unless otherwise specified. Therefore, do not grease or oil bolts or cap screws unless otherwise specified in this manual.

\* Torque value for bolts and cap screws are identified by their head markings.

## METRIC TORQUE SPECIFICATIONS

*NOTE: Wrench torque tolerance is  $\pm 20\%$ .*

Bolt Diameter	Property Class 8.8*		Property Class 10.9*	
	lb-ft	N-m	lb-ft	N-m
M5	5	6	7	9
M6	8	10	11	15
M8	18	25	26	35
M10	37	50	52	70
M12	66	90	92	125
M16	166	225	229	310
M20	321	435	450	610
M24	554	750	775	1050

Torque figures indicated above and in the Specification Sections of this manual are valid for non-greased or non-oiled threads and heads unless otherwise specified. Therefore, do not grease or oil bolts or cap screws unless otherwise specified in this manual.

\* Torque value for bolts and cap screws are identified by their property class head markings.

## RECOMMENDED TORQUES IN N-m, AND LB-FT FOR PIPE AND HOSE CONNECTIONS

Thread size	with O-rings		with cone	
	N-m	lb-ft	N-m	lb-ft
3/8-24 UNF	7.5	5.5	8	6
7/16-20 UNF	10	7	12	9
1/2-20 UNF	12	9	15	11
9/16-18 UNF	15	11	25	18
3/4-16 UNF	25	20	45	35
7/8-14 UNF	40	30	60	45
1-1/16-12 UNC	60	45	100	75
1-3/16-12 UNC	70	50	120	90
1-5/16-12 UNC	80	60	140	105
1-5/8-12 UNC	110	80	190	140
1-7/8-12 UNC	150	110	220	160

**SPECIAL TOOLS\***

**TUNE-UP**

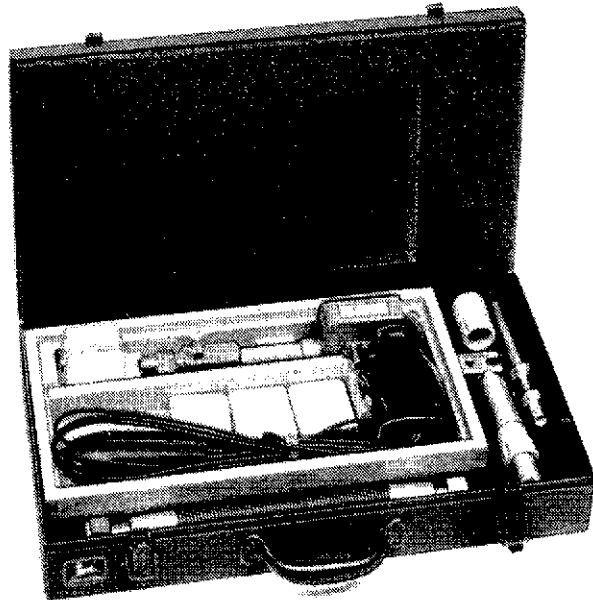
Tools	Description and Part No.	Use
	<p>Compression tester kit D-14546BA (FKM 10021)</p>	<p>Checking engine compression</p>

L30722

L30722

*Fig. 1—Compression Tester Kit*

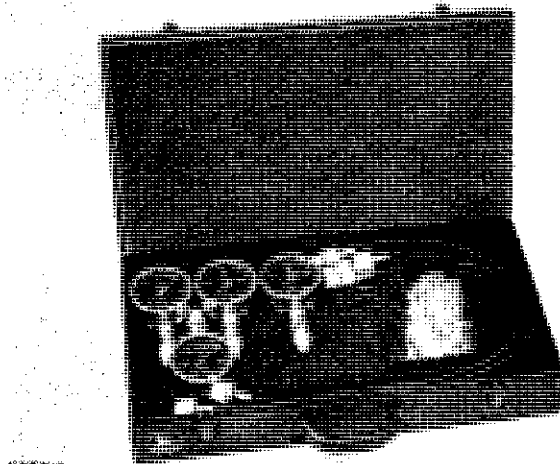

L30515

L30515

*Fig. 2—Pressure Gauge Set*

D-05022ST  
(FKM 10002)

Measuring air intake system vacuum

\*Numbers given in parenthesis are alternate tools for Canada. Order other tools using your SERVICE-GARD catalog.

**Tool**

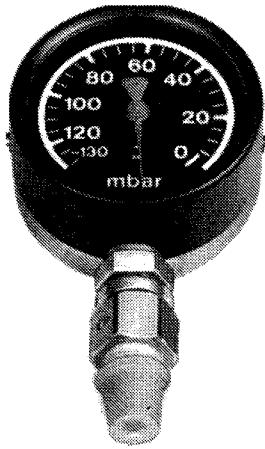

L30913

**Description and Part No.**

1 D-05022ST  
Vacuum gauge  
(FKM 10242)

**Use**

Measuring air intake  
system vacuum

L30913

Fig. 3—Vacuum Gauge and Connectors

**TRACTOR SEPARATION**

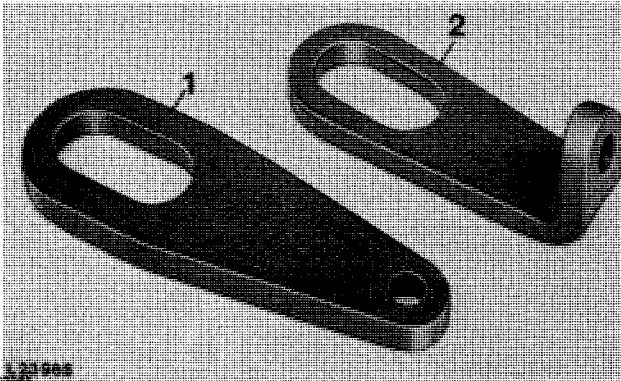

1 Lifting eye,  
straight  
JD-244-1

Tractor separation

2 Lifting eye,  
bent  
JD-244-2

Fig. 4—Lifting Eyes, Straight and Bent

Special ring spanner  
KJD-10129

Separating between  
engine and clutch housing  
(Tractors with SOUND-  
GARD Body)

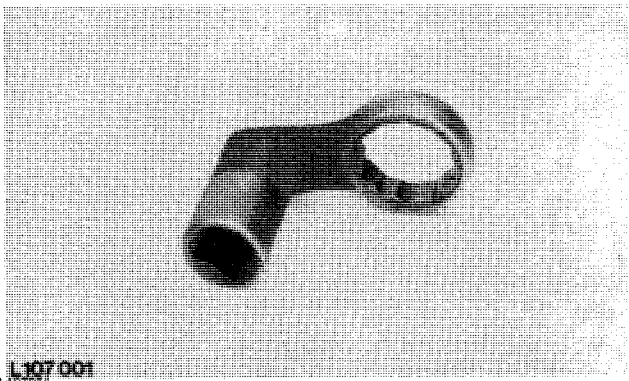
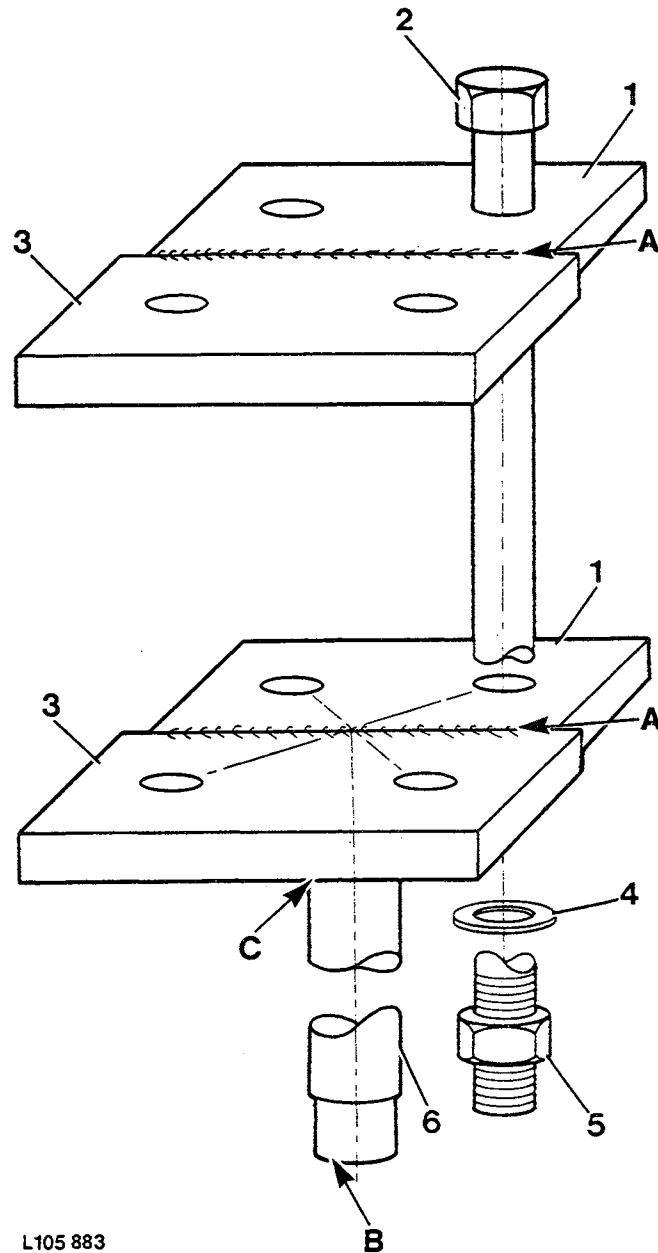

Fig. 5—Special Ring Spanner

Tractor Separation (Contd.)



L105 883

L105883

- |  |                              |   |
|--|------------------------------|---|
| A—Weld both retaining plates together              | 1—Retaining plate T 25671    | 4—Washer 14 H 1697 (2 used)                 |
| B—Adapter lug diameter to fit bore of trolley jack | 2—Cap screw L 29785 (2 used) | 5—Hex. nut 14 H 1039 (2 used)               |
| C—Weld round steel in center of both plates        | 3—Retaining plate T 32429    | 6—Round steel 50 x 250 mm (1.97 x 9.84 in.) |

Fig. 6—Holding Device (Self-Manufacture), Removal of Final Drive Assemblies

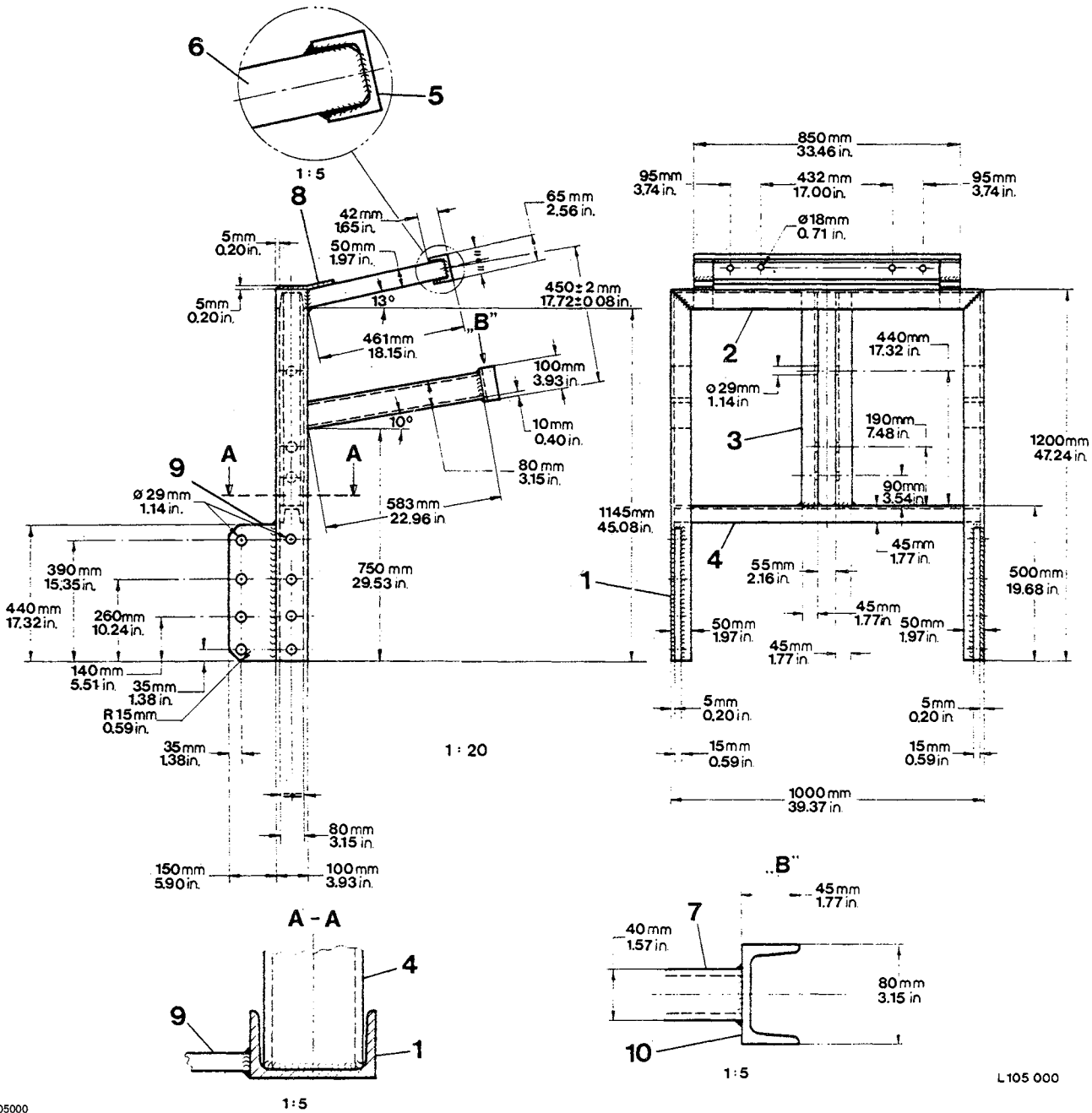

- 1—U-profile steel 100 x 1200 mm (3.94 x 47.24 in.) (2 used)
- 2—U-profile steel 100 x 1000 mm (3.94 x 39.37 in.) (1 used)
- 3—U-profile steel 80 x 694 mm (3.15 x 27.32 in.) (1 used)
- 4—U-profile steel 80 x 988 mm (3.15 x 38.9 in.) (1 used)
- 5—U-profile steel 65 x 850 mm (2.56 x 33.46 in.) (1 used)
- 6—Square steel 50 x 50 x 461 mm (1.97 x 1.97 x 18.15 in.) (2 used)
- 7—Square tubular steel 80 x 40 x 5 x 583 mm (3.15 x 1.58 x 0.2 x 22.95 in.) (2 used)
- 8—Flat steel 50 x 5 x 190 mm (1.97 x 0.2 x 7.48 in.) (2 used)
- 9—Flat steel 150 x 15 x 440 mm (5.9 x 0.59 x 17.32 in.) (2 used)
- 10—U-profile steel 80 x 100 mm (3.15 x 2.94 in.) (2 used)

Fig. 7—Lifting Device (Self-Manufacture), Removal of SOUND GARD Body (Quality Grade ST 37)

L105000

L105 000

**Tractor Separation (Contd.)**

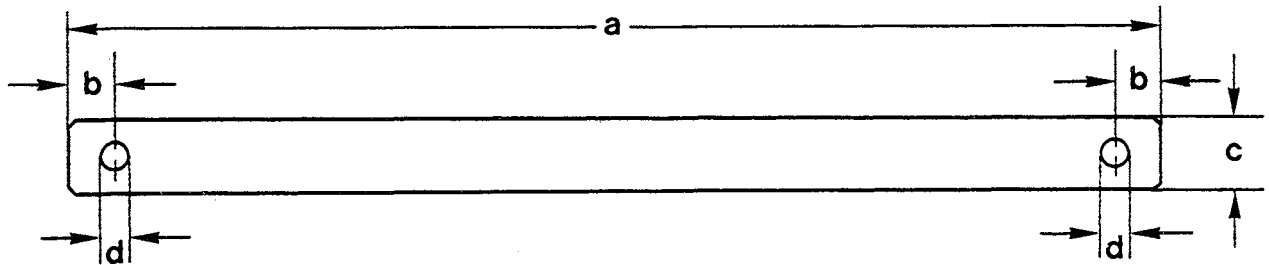

L105887

L105 887

a—1100 mm (43.31 in.)  
b—25 mm (0.98 in.)

c—Diameter 22 mm (0.87 in.) with Cat. I draft links  
29 mm (1.14 in.) with Cat. II draft links  
d—Diameter 5 mm (0.2 in.)

*Fig. 8—Steel Shaft (Self-Manufacture for SOUND-GARD Body Lifting Device)*



## Group 05

**PREDELIVERY, DELIVERY AND  
AFTER-SALES INSPECTIONS**

The John Deere Delivery Receipt, when properly filled out and signed by the dealer and customer, verifies that the predelivery and delivery services were satisfactorily performed. When delivering this machine, give the customer his copy of the delivery receipt and the operator's manual. Explain their purpose to him.

To promote complete customer satisfaction, a predelivery inspection including mending of possible shipping damage and giving the finishing touches to the tractor, is of prime importance to the dealer.

After the first 100 operating hours another inspection should be performed by the dealer to make sure that the tractor is in proper operating condition.

The predelivery and after-sale inspection check lists in the operator's manual will be completed by the dealer when the inspections are being performed. He will then forward them to the sales branch service department.

**Tractor Storage**

When storing a new tractor, proceed as follows:

**Short Term (Under 30 Days)**

1. Fill fuel tank. This prevents condensation of moisture in tank.
2. Check engine oil level, transmission-hydraulic oil level, and coolant level. Add oil or coolant if necessary. During cold weather, be sure coolant contains sufficient anti-freeze.

3. Check electrolyte level in batteries. If electrolyte does not cover plates, add distilled water. Make sure batteries are fully charged.

4. Store tractor in a dry, protected place. If necessary to store tractor outside, cover it with a protective material. Protect tires from heat, sunlight, and petroleum products.

**Long Term (Over 30 Days)**

To protect engine, fuel system, transmission and hydraulic system, use the AR41785 rust inhibitor. The above part no. includes one can of rust inhibitor, masking tape and protective caps to cover all engine openings.

Protect as follows:

1. Add 255 cm<sup>3</sup> (9 oz) of rust inhibitor to the engine oil.
2. Add rust inhibitor to transmission/hydraulic oil as follows:
  - Synchronized transmission
    - 230 cm<sup>3</sup> (8 oz) on 2350 tractors
    - 250 cm<sup>3</sup> (8.5 oz) on 2550 tractors
  - Collar shift transmission
    - 160 cm<sup>3</sup> (5.5 oz) on 2350 and 2550 tractors

3. Drain fuel tank, pour 170 cm<sup>3</sup> (6 oz) of rust inhibitor into the empty tank and add approx. 10 L (2.6 U.S. gal) of fuel. Start engine and operate it at fast idle for 15 to 20 minutes to distribute the mixture through the whole fuel system. While the engine is running, operate the complete hydraulic system several times. Shut off engine in time to leave some fuel in the tank. Then allow the engine to cool down for 15 to 20 minutes.

4. Prepare 15 cm<sup>3</sup> (0.5 oz) of rust inhibitor for each cylinder. Remove plug of intake manifold or connecting pipe of starting fluid adapter at the intake manifold,

After the rust inhibitor has been added, the engine may not be started again.

**IMPORTANT: Rust inhibitor agents evaporate very easily. For this reason, seal all openings after the inhibitor has been added. Also, always keep the inhibitor container closed.**

5. Fill the fuel tank.
6. Remove batteries. Add distilled water, if necessary. Charge the batteries and store in a cool, dry place where they will not freeze.
7. Seal all openings such as the vent tube and exhaust outlet.
8. Slacken fan belt and air conditioning compressor belt (if equipped).
9. Replace or repair damaged parts. Touch up any painted surfaces which are scratched or chipped.
10. Coat exposed metal surfaces, such as axles and piston rods of hydraulic cylinders, with grease or corrosion preventative.
11. Store the tractor in a dry, protected place. If the tractor is stored outside, cover it with a waterproof tarpaulin.
12. Block up the tractor so that tires do not touch the ground. Protect tires from heat and sunlight.

## Removing the Tractor from Storage

1. Remove all protective coverings.
2. Check crankcase and transmission/hydraulic system oil levels.
3. Check coolant level.
4. Check tire inflation pressure.
5. Install batteries and connect cable and ground strap.
6. Adjust fan belt and compressor belt (if equipped) tension.
7. Carry out 500-hour check.
8. Run engine at approx. 1500 rpm for some minutes. Check all systems before placing tractor under load.

## PREDELIVERY INSPECTION

Before delivering the tractor to the customer, the following checks and services should be performed by the dealer:

### Engine

#### Leaks

1. Check engine and fuel lines for leaks. Repair as necessary.

#### Checking Crankcase Oil Level

*NOTE: Tractor should be on a level surface when oil level is checked. If it is not, check only to make sure the crankcase is not dry. Recheck oil level later, when tractor is on level ground.*

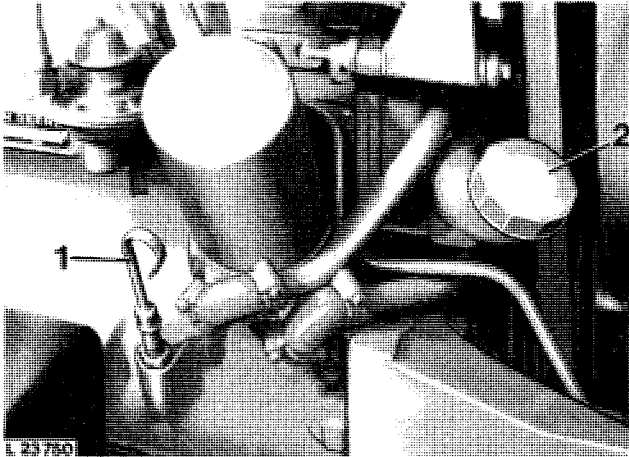

L23750

- 1—Dipstick  
2—Filler Cap

Fig. 1—Engine Oil Dipstick and Filler Cap

1. Pull out dipstick (1, Fig. 1) and check oil level.
2. If necessary, add oil to bring oil level to top mark on dipstick. Use John Deere Torq-Gard Supreme engine oil SAE 10W-20 or an equivalent oil. (See Group 10.)

### Checking Coolant Level



L100118

Fig. 2—Radiator Filler Cap

1. Remove radiator filler cap and check coolant level. Coolant level must be midway between the filler neck and top of radiator core.

2. If necessary, add coolant to obtain this level.

John Deere Engine Cooling Fluid is filled into the cooling system at the factory. It protects the engine against corrosion and against frost down to  $-36^{\circ}\text{C}$  ( $-35^{\circ}\text{F}$ ).

**IMPORTANT: Use only John Deere Engine Cooling Fluid in the cooling system, independent of the season.**

If no John Deere Engine Cooling Fluid is available use a mixture of 50 per cent ethylene-glycol antifreeze/anticorrosion inhibitor and 50 per cent clear, soft water. This mixture guarantees engine protection against corrosion and against frost down to  $-36^{\circ}\text{C}$  ( $-35^{\circ}\text{F}$ ).

Never use any cooling system sealing additives.

### Idle Speeds

1. Warm up engine to operating temperature and check slow and fast idle speeds. Adjust, if necessary. (See Section 30, Group 30.)
2. Slow idle speed: 700 to 800 rpm.
3. Fast idle speed: 2610 to 2660 rpm.

### Engine Shut-Off Cable

1. Check operation of shut-off cable. Move hand throttle lever completely forward and idle engine for 1 to 2 minutes.
2. Completely pull out shut-off knob, making sure engine stops immediately.
3. If necessary, adjust shut-off cable. (See Section 30, Group 30.)

### Air Cleaner and Safety Element

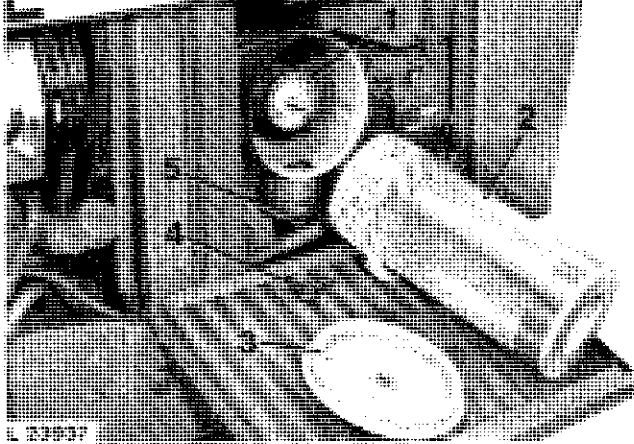

L22997

- |                         |                          |
|-------------------------|--------------------------|
| 1 - Safety Element      | 4 - Wing Nut             |
| 2 - Air Cleaner Element | 5 - Dust Unloading Valve |
| 3 - Cover               |                          |

Fig. 3 - Air Cleaner and Safety Element

1. Check air cleaner element and safety element for proper installation.

2. Make sure that dust unloading valve (5, Fig. 3) (rubber cap) is installed on air cleaner.

### Air Intake Connections

1. Check air intake connections for tightness. Tighten any loose clamps.

### Exhaust Stack

1. Install exhaust stack, making sure it is in vertical position.

2. Install exhaust stack flap with flap hinge at the rear (as seen in direction of forward travel). When closed, flap should not contact exhaust stack end. If necessary, clamp flap to exhaust stack to obtain a clearance of 2 mm (0.08 in.) between flap and stack end.

### Checking V-Belt Tension

1. The fan belt should have 19 mm ( $\frac{3}{4}$  in.) flex with 90 N (20 lb) pull midway between crankshaft and alternator or water pump (use a spring scale).

2. Compressor belt should deflect 6 mm ( $\frac{1}{4}$  in.) when a 70 N (15 lb) force is applied midway between pulleys.

### Electrical System

#### Batteries

1. Check battery terminals and battery cable ends. If they are corroded, clean and coat them with petroleum jelly.

2. Check electrolyte level in each battery cell. Add distilled water if necessary to bring level above cell plates.

3. If batteries are not fully charged, charge them. Remove cell caps before charging the battery.

**IMPORTANT:** If the engine is to be run for a short time without battery (using a slave battery for starting), do not, under any circumstances, interrupt the circuit by switching off the main switch before stopping the engine by means of the fuel pump shut-off cable. Further it is recommended to use additional current (lights) while engine is running. Do not run engine at a speed above 1000 rpm. Insulate battery end of disconnected starter cable properly to avoid damage to alternator and regulator.

On tractors with Sound-Gard Body, do not connect ground strap of slave battery to cab.

2. Connect batteries or battery charger in the proper polarity (“+” and “-”). If they are improperly connected, the rectifier diodes will be immediately destroyed.

### Start Safety Switch

1. Move range shift lever into neutral position.
2. Check function of start safety switch. Replace switch when necessary. (See Section 40, Group 15.)

### Lighting System

1. Check lighting system and repair as necessary. Replace any defective bulbs. (See Section 40, Group 20.)
2. Check headlight adjustment and correct, if necessary. (See Section 40, Group 20.)

### SOUND-GARD Body Controls

#### Fan Switch

1. Open air outlets. Check fan switch (2, Fig. 4) for proper operation.

#### Heater Switch

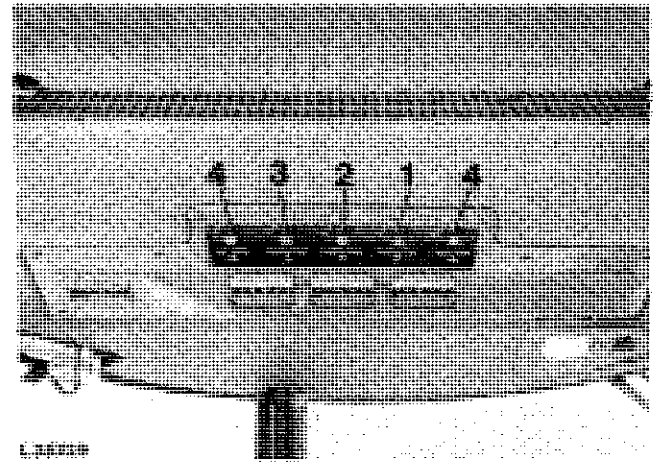

L35229

1—Heater Switch  
2—Fan Switch

3—Thermostat Switch  
(Air Conditioning)  
4—Windshield Wiper Switch

Fig. 4—SOUND-GARD Body Controls

With fan operating, check heater switch (1, Fig. 4) for proper operation. For this purpose, turn switch to the right, making sure that warm air enters SOUND-GARD body (with engine at operating temperature).

#### *Thermostat Switch (Tractors with Air Conditioning)*

With fan operating, check infinitely variable thermostat switch (if equipped) for proper operation. Turn off heater. turn thermostat switch 3 (Fig. 4) clockwise, making sure cool air enters SOUND-GARD body. If switch does not operate correctly, see Section 90, Group 05.

#### *Windshield Wiper Switch*

Check windshield wiper switch for proper operation.

#### *Controls and Instruments*

Check controls and instruments for proper operation.

## Power Train

### Checking Transmission/Hydraulic System Oil Level

1. With the tractor on level ground, run engine 2 to 3 minutes.
2. Place range and gear shift lever in neutral position.
3. Apply handbrake.
4. Lower draft links.
5. Run engine at slow idle (700 to 800 rpm).

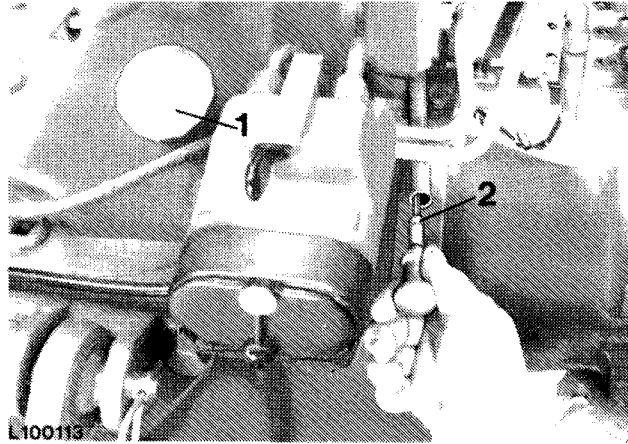

L10011 3

1—Filler Cap  
2—Dipstick

*Fig. 5—Transmission/Hydraulic System Dipstick and Filler Cap*

6. Pull out dipstick and wipe clean.
7. Insert dipstick. Remove dipstick and check oil level.
8. If necessary, add John Deere HY-GARD Transmission and Hydraulic Oil or equivalent oil to bring oil level to top mark on dipstick.

**NOTE:** *Types of oil not meeting our specifications will not give satisfactory service and may result in eventual damage.*

6. Pull out dipstick and wipe clean.
7. Insert dipstick. Remove dipstick and check oil level.
8. If necessary, add John Deere HY-GARD Transmission and Hydraulic Oil or equivalent oil to bring oil level to top mark on dipstick.

*NOTE: Types of oil not meeting our specifications will not give satisfactory service and may result in eventual damage.*

### **TRANSMISSION**

1. Check transmission for proper operation.
2. While driving tractor, shift transmission through all gears. If transmission does not function properly, refer to Section 50, Groups 30 or 31.

### **DIFFERENTIAL LOCK**

Check differential lock for proper operation. If you find any problem, refer to Section 50, Group 35.

### **PTO**

Check PTO operation. For this purpose, run engine and move PTO control lever to engaged and disengaged position. If PTO does not operate properly, refer to Section 50, Group 45.

### **HI-LO SHIFT UNIT**

Check Hi-Lo shift unit as follows:

1. Operate tractor in both high and low ranges, carefully observing both operations.
2. Use the brakes to simulate a load condition on the tractor.
3. Low oil pressure will be indicated by disk pack slippage, which causes the clutch pack to become noisy.
4. A mechanical failure in the Hi-Lo shift unit will also be indicated by unusual noise.
5. If you find any problems, refer to Section 50, Group 20.

### **REVERSER TRANSMISSION**

Check function of reverser transmission. If you find any problems, refer to Section 50, Group 21.

### **CREEPER TRANSMISSION**

Check function of creeper transmission as follows:

1. Drive the tractor, disengage the clutch, engage creeper transmission and engage gears of range 1 and Reverse.
2. Refer to Section 50, Group 22 should a malfunction occur.

### **CLUTCH PEDAL**

#### **Tractors With SOUND-GARD Body**

1. Check clutch pedal free travel. It should be approximately 25 mm (1 in.).
2. Make sure that clutch is fully disengaged before pedal contacts stop bracket. Adjust clutch pedal free travel, if necessary. (See Section 50, Group 10.)

#### **Tractors Without SOUND-GARD Body**

1. Depress clutch pedal until it contacts stop. When doing this the operating rod should move 8.5 to 12.0 mm (5/16 to 1/2 in.) out of clutch operating cylinder.
2. When necessary, bleed clutch operating system. (See Section 50, Group 10.)

#### **Tractors with Reverser**

1. Check clutch pedal adjustment.
2. There should be 133 mm (5.25 in.) between engine mounting flange and the rear of clutch pedal pad.
3. Adjust clutch pedal, if necessary. (See Section 50, Group 10.)

### **MECHANICAL FRONT WHEEL DRIVE**

#### **Checking Axle Housing Oil Level**

1. Remove level plug (1, Fig. 6). oil should be level with plug bore.
2. If necessary, top up with oil, using oil as specified in Group 10 of this section.

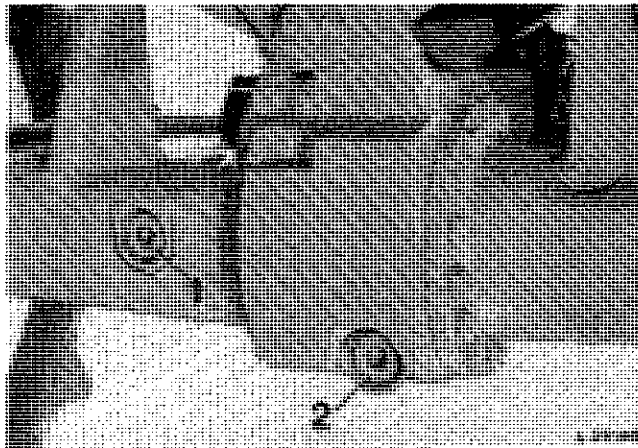

L35195

- 1—Level Plug  
2—Drain Plug

Fig. 6—Checking Axle Housing Oil Level

#### Checking Wheel Hub Housing Oil Level

1. Turn wheel until mark (2, Fig. 7) is in level position.
2. Remove level plug (1). Oil should be level with plug bore.

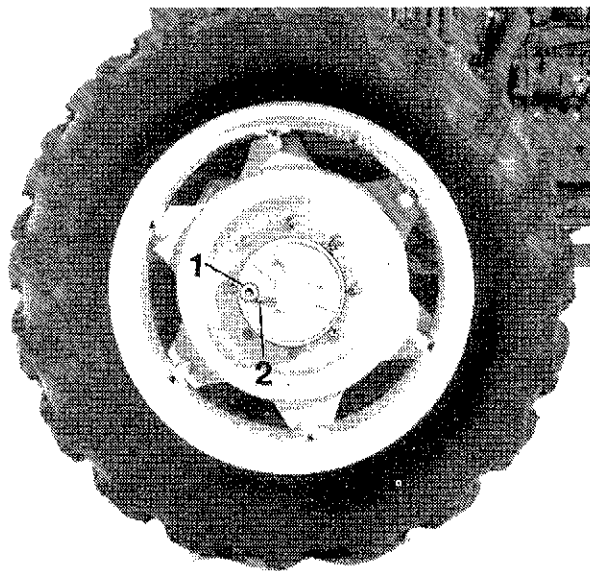

L 35196

- 1—Level Plug  
2—Oil Level Mark

Fig. 7—Checking Wheel Hub Housing

3. Add oil, if necessary, using oil as specified in Group 10 of this section.

#### MFWD Operation

Check MFWD for proper operation. If you find any problems, refer to Section 50, Group 50.

#### Steering and Brakes

##### Steering

Check steering system for proper operation. In case of a malfunction, refer to Section 60, Group 05.

##### Brakes

Check footbrakes and handbrake for proper operation. Adjust brakes, if necessary. Refer to Section 60, Group 10 if a malfunction occurs.

#### Hydraulic System

##### Leaks

Check entire hydraulic system for leaks. Repair components when necessary.

##### Rockshaft

Check rockshaft operation. In case of a malfunction, refer to Section 70, Group 20.

##### Selective Control Valves

Check operation of selective control valves. In case of a malfunction, refer to Section 70, Group 25.

##### Three-Point Hitch

Install and/or adjust draft links and center link. (See operator's manual.)

L35196

**Miscellaneous****Wheel Bolts**

Tighten all wheel bolts to the specified torque. (See Section 80, Group 10.)

**Tire Pressures**

Check tire pressures. (See operator's manual.)

**Tread Width**

Adjust tread width to customer's needs. (See operator's manual.)

**Toe-In**

Check toe-in and adjust, if necessary. (See Section 80, Group 05.)

**Lubricating Points**

Lubricate all lubricating points on tractor.

**ROLL-GARD**

1. Check ROLL-GARD for proper installation.
2. Tighten cap screws to specified torque. (See Section 90, Group 25.)

**Guards**

Check all guards for proper installation.

**Decals and Paint**

Check decals and paint for proper condition.

**SOUND-GARD BODY****Air Conditioning System**

1. Check operation of air conditioning system. If you find any problems, refer to Section 90, Group 05.
2. Check refrigerant lines for leaks. Repair or replace parts as necessary.

**Operator's Seat**

1. Check whether operator's seat can be adjusted properly.
2. Check seat belt for proper condition and correct installation.

**SOUND-GARD Body**

1. Check SOUND-GARD body for proper installation.
2. Tighten attaching cap screws to specified torque. (See Section 90, Group 20.)

**DELIVERY INSPECTION**

A thorough discussion of the operation and service of the tractor at the time of its delivery helps to assure complete customer satisfaction.

Proper delivery should be an important part of the dealer's program.

It is a well-known fact that many complaints have arisen simply because the owner was not shown how to operate and service his new tractor properly. Therefore, enough time should be devoted, at the customer's convenience, to introducing him to his new tractor and explaining to him how to operate and service it.

Using the tractor operator's manual as a guide, be sure that the owner understands the following points properly:

1. Operation of control levers and instruments.
2. Starting and shutting off the engine.
3. The importance of the tractor break-in period.
4. Use of counterweights and proper tire inflation pressure as well as filling of tires with water and calcium chloride, if required.
5. All functions of the hydraulic system.
6. Operating the PTO.
7. The importance of the safety rules.
8. The importance of lubrication and periodic service.

Give particular emphasis to sway blocks, rockshaft speed-of-drop, rockshaft selector lever (load and depth control), transmission oil pressure indicator light, engine oil pressure indicator light (whether temperature or pressure and what to do if lights go on), alternator indicator light (indicating whether alternator is charging) and Sound-Gard Body air filters. These areas are very often misunderstood.

## AFTER-SALES INSPECTION

In the interest of the purchaser and the dealer an after-sales inspection should be carried out by the dealer after the first 100 hours of using a new John Deere tractor.

The purpose of this inspection is to make sure that the customer is receiving satisfactory performance from his tractor. At the same time, the inspection should reveal whether or not the tractor is being operated, lubricated and serviced properly.

Through this inspection a needless volume of service work can be eliminated by preventing minor difficulties from developing into serious problems later on. It also will promote stronger dealer-customer relations and give the customer an opportunity to ask questions that may have arisen during the first few days of use.

Thereby the dealer has the further opportunity of promoting the possible sale of other new equipment.

The following inspection program is recommended:

### Engine

#### Leaks

Check engine and fuel lines for leaks. Repair as necessary.

#### Oil and Filter Change

*NOTE: Drain oil with engine shut off, however, with engine oil warm.*

1. Remove drain plug.
2. While oil is draining, replace filter element.

3. Remove filter element (turn counterclockwise) and clean mounting surface.
4. Apply a thin film of oil to sealing ring of new filter. Tighten filter element until sealing ring touches mounting surface, then turn an additional 1/2 to 3/4 turns. Do not overtighten.
5. Reinstall drain plug.
6. Fill crankcase with fresh oil of the proper viscosity. (See Group 10.)

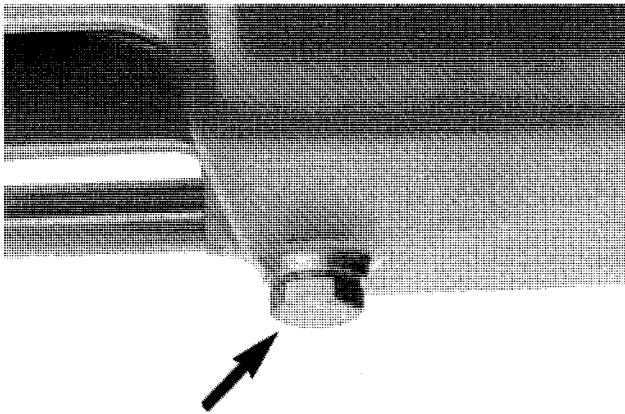

L 23999

L23999

Fig. 8—Crankcase Drain Plug

7. Crankcase capacity with filter change: 8.5L (2.25 U.S. gal.).
8. Run engine for a short time and check for leaks at filter base and drain plug.

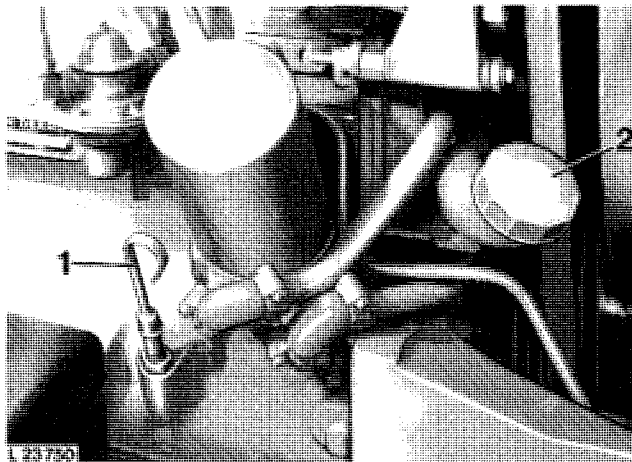

L23750

1—Dipstick  
2—Filler Cap

Fig. 9—Engine Oil Dipstick and Filler Cap

9. Stop engine.
10. Check oil level.

**Checking Valve Clearance**

Using a feeler gauge, check valve clearance. (See Section 20, Group 10.)

Valve clearance (with the engine cold or warm)

Intake valve .....	0.35 mm (0.014 in.)
Exhaust valve .....	0.45 mm (0.018 in.)

**Checking Coolant Level**

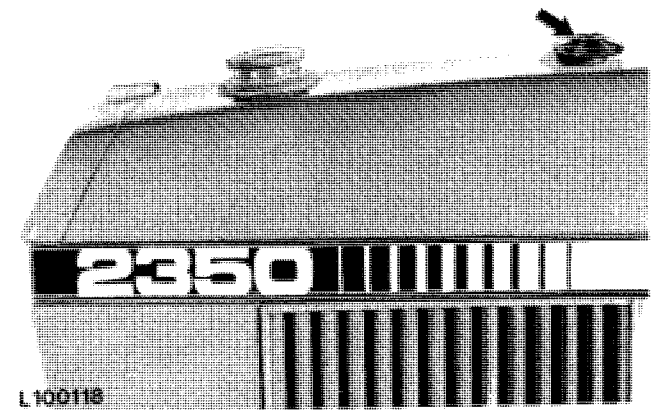

L100118

L10011 8

Fig. 10—Radiator Filler Cap

1. Remove radiator filler cap and check coolant level. Coolant level must be midway between the filler neck and top of radiator core.
2. If necessary, add coolant to obtain this level. (See page 3.)

**Idle Speeds**

1. Warm up engine to operating temperature and check slow and fast idle speeds. Adjust, if necessary. (See Section 30, Group 30.)
2. SLow idle speed: 700 to 800 rpm.
3. Fast idle speed: 2610 to 2660 rpm.

### Hand Throttle Lever

Check whether hand throttle lever can be moved properly. Adjust, if necessary.

### Engine Shut-Off Cable

1. Check operation of shut-off cable. Move hand throttle lever completely forward and idle engine for 1 to 2 minutes.

2. Completely pull out shut-off knob, making sure engine stops immediately.

3. If necessary, adjust shut-off cable (see Section 30, Group 30).

### Air Cleaner and Safety Element

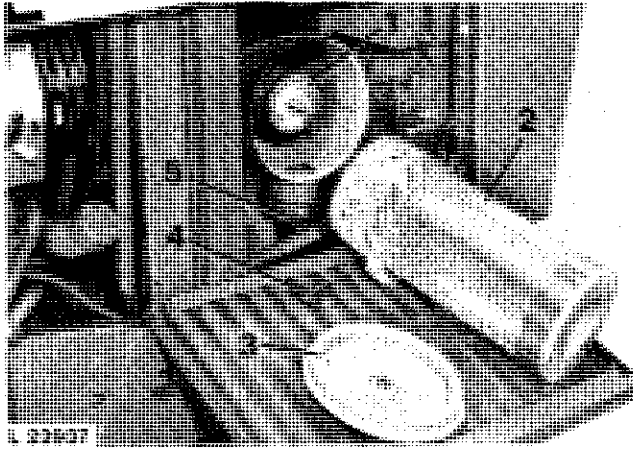

- 1 - Safety Element
- 2 - Air Cleaner Element
- 3 - Cover
- 4 - Wing Nut
- 5 - Dust Unloading Valve

*Fig. 11 - Air Cleaner and Safety Element*

1. Check air cleaner and safety elements for proper installation.

2. Make sure that dust unloading valve (5, Fig. 11) (rubber cap) is installed on air cleaner.

### Air Intake Connections

Check air intake connections for tightness. Tighten any loose clamps.

### Checking V-Belt Tension

The fan belt should have 19 mm ( $\frac{3}{4}$  in.) flex with 90 N (20 lb) pull midway between crankshaft and alternator or water pump (use a spring scale).

Compressor belt should deflect 6 mm ( $\frac{1}{4}$  in.) when a 70 N (15 lb) force is applied midway between pulleys.

## Electrical System

### Batteries

1. Check battery terminals and battery cable ends. If they are corroded, clean and coat them with petroleum jelly.

2. Check specific gravity of battery cells. At an electrolyte temperature of 20°C (68°F), a fully charged battery should have a specific gravity of 1.28 under normal and arctic conditions and 1.23 in tropical areas.

3. Check electrolyte level in each battery cell. Add distilled water if necessary to bring level above cell plates.

4. If batteries are not fully charged, charge them. Remove cell caps before charging the battery.

**IMPORTANT:** 1.If the engine is to be run for a short time without battery (using a slave battery for starting), do not under any circumstances, interrupt the circuit by switching off the main switch before stopping the engine by means of the fuel pump shut-off cable. Further it is recommended to use additional current (lights) while engine is running. Do not run engine at a speed above 1000 rpm. Insulate battery end of disconnected starter cable properly to avoid damage to alternator and regulator.

On tractors with SOUND-GARD body, do not connect ground strap of slave battery to SOUND-GARD body.

2. Connect batteries or battery charger in the proper polarity (“+” and “-”). If they are improperly connected, the rectifier diodes will be immediately destroyed.

#### Start Safety Switch

1. Move range shift lever into neutral position.
2. Check function of start safety switch. Replace switch when necessary. (See Section 40, Group 15.)

#### Lighting System

1. Check lighting system and repair as necessary. Replace any defective bulbs. (See Section 40, Group 20.)
2. Check headlight adjustment and correct, if necessary. (See Section 40, Group 20.)

#### SOUND-GARD Body Controls

##### *Fan Switch*

Open air outlets. Check fan switch (2, Fig. 12) for proper operation.

##### *Heater Switch*

With fan operating, check heater switch (1, Fig. 12) for proper operation. For this purpose, turn switch to the **right**, making sure that warm air enters SOUND-GARD body (with engine at operating temperature).

If this is not the case, replace heater switch. If necessary, check coolant flow through heater core. (See Section 90, Group 10.)

##### *Thermostat Switch (Tractors with Air Conditioning)*

With fan operating, check infinitely variable thermostat switch (if equipped) for proper operation. Turn off heater. Turn thermostat switch (3, Fig. 12) clockwise, making sure cool air enters SOUND-GARD body. If switch does not operate correctly, see Section 90, Group 05.

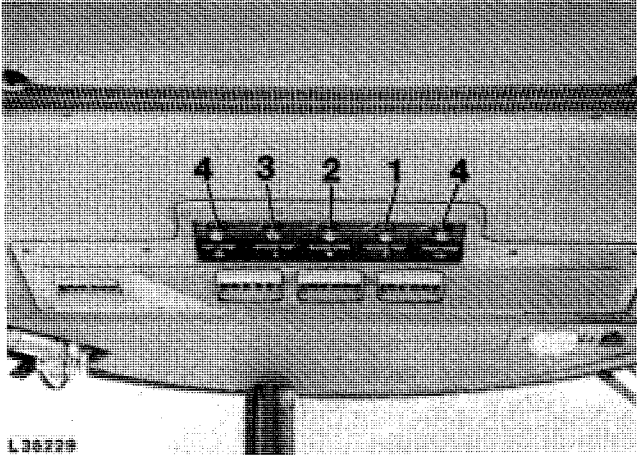

L35229

L35229

- 1—Heater Switch  
2—Fan Switch  
3—Thermostat Switch  
(Air Conditioning)  
4—Windshield Wiper Switch

Fig. 12—SOUND-GARD Body Controls

#### Windshield Wiper Switch

Check windshield wiper switch for proper operation.

#### Controls and Instruments

Check controls and instruments for proper operation.

#### POWER TRAIN

##### Checking Transmission/Hydraulic System Oil Level

1. With the tractor on level ground, run the engine 2 to 3 minutes.

2. Place range and gear shift lever in neutral position.
3. Apply handbrake.
4. Lower draft links.
5. Run engine at slow idle (700 to 800 rpm).

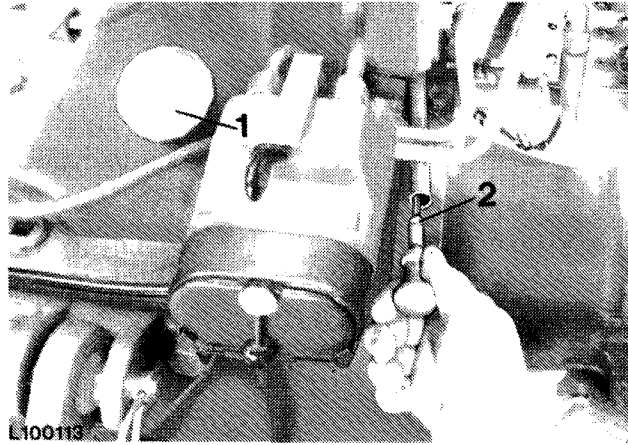

L100113

L100113

- 1—Filler Cap  
2—Dipstick

Fig. 13—Transmission/Hydraulic System Dipstick and Filler Cap

6. Pull out dipstick and wipe clean.
7. Insert dipstick. Remove dipstick and check oil level.
8. If necessary, add John Deere HY-GARD Transmission and Hydraulic Oil or equivalent oil (see Group 10) to bring oil level to top mark on dipstick.

**NOTE:** Types of oil not meeting our specifications will not give satisfactory service and may result in eventual damage.

**TRANSMISSION**

1. Check transmission for proper operation.
2. While driving tractor, shift transmission through all gears. If transmission does not function properly, refer to Section 25, Group 30 or 31.

**DIFFERENTIAL LOCK**

Check differential lock for proper operation. If you find any problem, refer to Section 50, Group 35.

**PTO**

Check PTO operation. For this purpose, run engine and move PTO control lever to engaged and disengaged position. If PTO does not operate properly, refer to Section 50, Group 45.

**HI-LO SHIFT UNIT**

Check Hi-Lo shift unit as follows:

1. Operate tractor in both high and low range, carefully observing both operations.
2. Use the brakes to simulate a load condition on the tractor.
3. Low oil pressure will be indicated by disk pack slippage, which causes the clutch pack to become noisy.
4. A mechanical failure in the Hi-Lo shift unit will also be indicated by unusual noise.
5. If you find any problems, refer to Section 50, Group 20.

**CREEPER TRANSMISSION**

Check function of creeper transmission as follows:

1. Drive the tractor, disengage the clutch, engage creeper transmission and engage gears of range I and Reverse.
2. Refer to Section 50, Group 25 should a malfunction occur.

**REVERSER TRANSMISSION**

Check function of reverser transmission. If you find any problems, refer to Section 50, Group 21.

**CLUTCH PEDAL****Tractors Without SOUND-GARD Body**

1. Check clutch pedal free travel. It should be approximately 25 mm (1 in.).
2. Make sure that clutch is fully disengaged before pedal contacts stop bracket. Adjust clutch pedal travel, if necessary. (See Section 50, Group 10.)

**Tractors With SOUND-GARD Body**

1. Depress clutch pedal until it contacts stop. When doing this the operating rod should move 8.5 to 2.0 mm (5/16 to 1/2 in.) out of clutch operating cylinder.
2. When necessary, bleed clutch operating system. (See Section 50, Group 10.)

**Tractors With Reverser**

1. Check clutch pedal adjustment.
2. There should be 133 mm (5.25 in.) between engine mounting flange and the rear of clutch pedal pad.
3. Adjust clutch pedal, if necessary. (See Section 50, Group 10.)

## Mechanical Front Wheel Drive

### Axle Housing Oil Change

1. Remove drain plug (2, Fig. 14) and drain oil.
2. Reinstall drain plug and tighten securely.
3. Remove level plug. Fill with fresh oil (5.0 L; 1.3 U.S. gal.) up to level oil plug bore. Reinstall level (filler) plug.

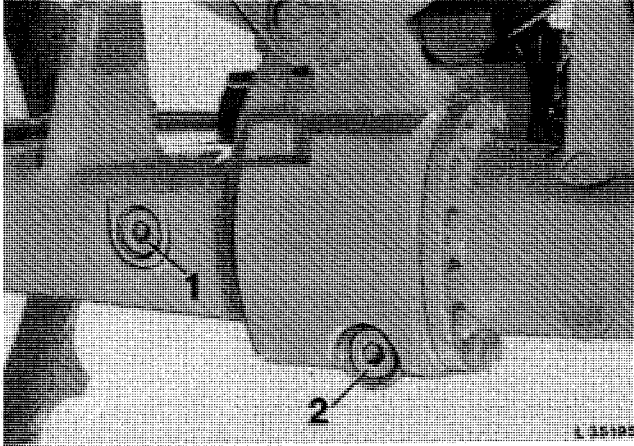

L35195

- 1—Level Plug  
2—Drain Plug

Fig. 14—Axle Housing Oil Level

### Wheel Hub Housing

1. Turn wheel until level plug (1, Fig. 15) is at the bottom. Remove drain plug and drain oil.
2. Turn wheel until mark (2, Fig. 15) is in level position.
3. Fill fresh oil (approx. 0.75 L; 0.2 U.S. gal.) through level plug bore. Use EP transmission oil according to specifications given in Group 10.
4. Oil should be level with plug bore. Reinstall level plug (2).

**NOTE:** Drain oil immediately after having operated the tractor for some time when the oil is still warm.

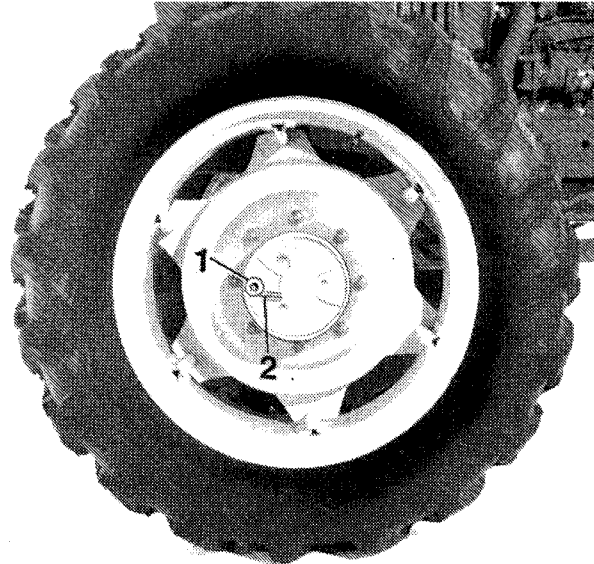

L 35196

L35196

- 1—Level Plug  
2—Oil Level Mark

Fig. 15—Final Drives Oil Level

### MFWD Operation

Check MFWD for proper operation. If you find any problems, refer to Section 50, Group 50.

### Steering

Check steering system for proper operation. In case of a malfunction, refer to Section 60, Group 05.

### Brakes

Check footbrakes and handbrake for proper operation. Adjust brakes, if necessary. Refer to Section 60, Group 10 if a malfunction occurs.

**Hydraulic System****Rockshaft**

Check rockshaft operation. In case of a malfunction, refer to Section 70, Group 20.

**Selective Control Valves**

Check operation of selective control valves. In case of a malfunction, refer to Section 70, Group 25.

**Leaks**

Check entire hydraulic system for leaks. Repair or replace components as necessary.

**Miscellaneous****Guards**

Check all guards for proper installation.

**ROLL-GARD**

1. Check ROLL-GARD for proper installation.
2. Tighten cap screws to specified torque. (See Section 90, Group 25.)

**SOUND-GARD Body****Air Conditioning System**

1. Check operation of air conditioning system. If you find any problems, refer to Section 90, Group 05.
2. Check refrigerant lines for leaks. Repair or replace parts as necessary.

**Operator's Seat**

1. Check whether operator's seat can be adjusted properly.
2. Check seat belt for proper condition and correct installation.

**SOUND-GARD Body**

1. Check SOUND-GARD Body for proper installation.
2. Tighten attaching cap screws to specified torque. (See Section 90, Group 20.)



## Group 10 LUBRICATION AND SERVICE

Effective use of lubricating oils and greases is perhaps the most important step toward low upkeep costs, long tractor life, and satisfactory service. Use only lubricants specified in this section.

### Engine Lubricating Oil

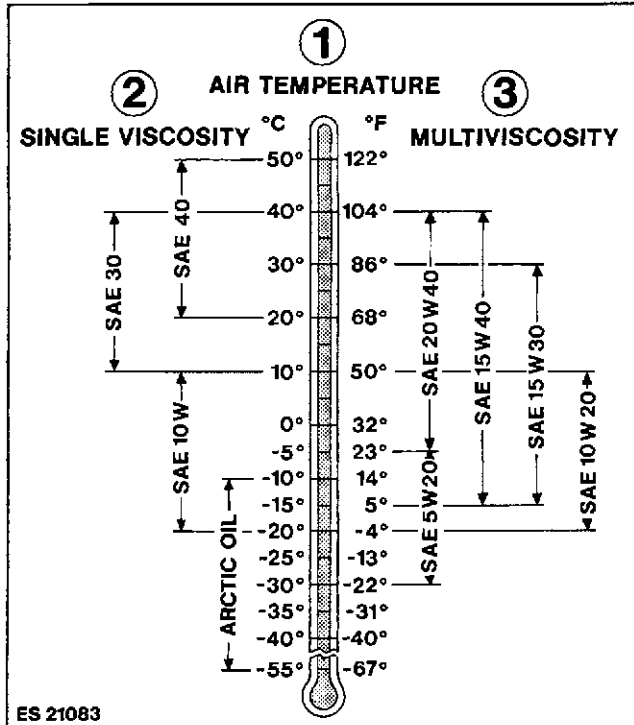

Fig. 1 - Oil Viscosity at Expected Temperature

**NOTE:** Depending on the lowest expected atmospheric temperature at start for the fill period, use oil of viscosity as shown in Fig. 1.

John Deere TORQ-GARD SUPREME® engine oil or John Deere HD Engine Oil is recommended. If other oils are used, they must be premium engine oils meeting performance requirements of:

- API Service Classification CD/SC
- Military Specification MIL-L2104C

For low temperature operation, where oils meeting the above requirements may not be available in appropriate viscosity grade, oils meeting the performance

requirements of API Service Classification CC/SC or Military Specification MIL-L-46152 or MIL-L-46167 (Arctic Oil) may be used but at shorter drain intervals.

Quality engine oils are blended, so additives are neither required nor recommended.

**NOTE:** Some increase in oil consumption may be expected when SAE 5W-20 or Arctic Oils are used. Check oil level more frequently.

### Transmission-Hydraulic Oil

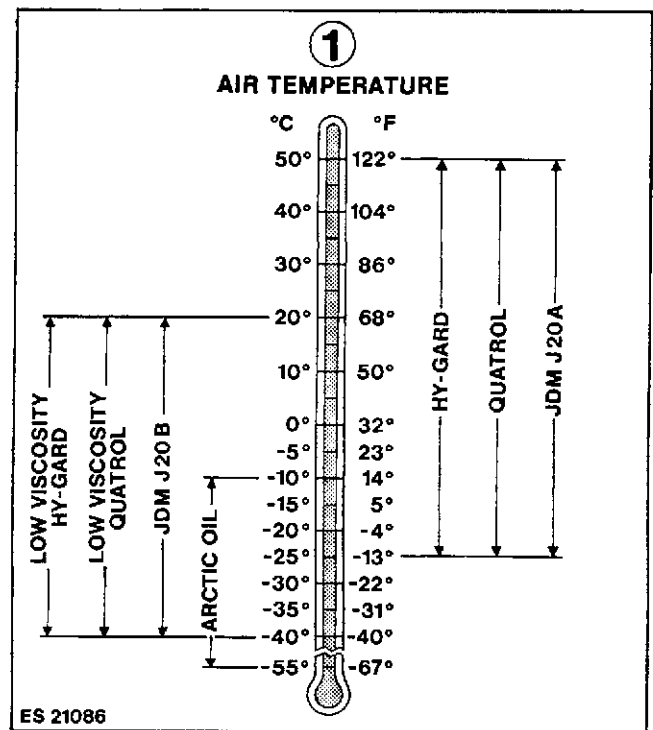

ES21086

Fig. 2 - Oil Viscosity at Expected Temperature

John Deere HY-GARD® transmission and hydraulic oil is recommended.

You may also use QUATROL® oil, or other oils meeting John Deere Standard JDM J20A or JDM J20B.

For temperature below  $-40^{\circ}\text{C}$  ( $-40^{\circ}\text{F}$ ) use Arctic Oil (API-CC/SC, MIL-L-46167).

### Oil for Mechanical Front Wheel Drive

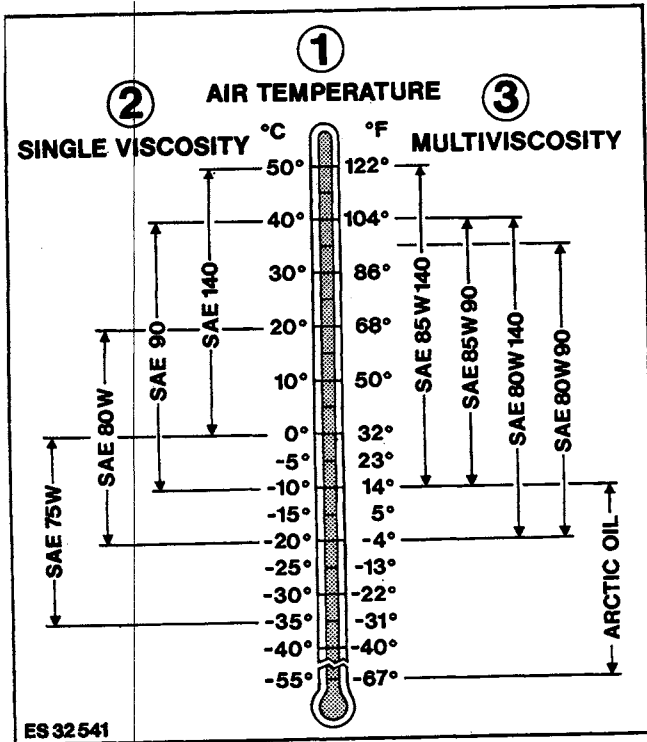

ES32541 Fig. 3 - Oil Viscosity at Expected Temperature

John Deere API GL-5 gear oil is recommended.

You may also use other EP transmission oils meeting performance requirements of:

- API Service Classification GL-5
- Military Specification MIL-L-2105B
- Military Specification MIL-L-2105C

At temperature below  $-35^{\circ}\text{C}$  ( $-31^{\circ}\text{F}$ ) use Arctic Oil (API-CC/SC, MIL-L-10324A).

### Brake Fluid for Hydraulic Operated Clutch

For tractors with hydraulic operated clutch (tractors with SOUND-GARD Body), use brake fluid meeting SAE standard J 1703.

### Grease

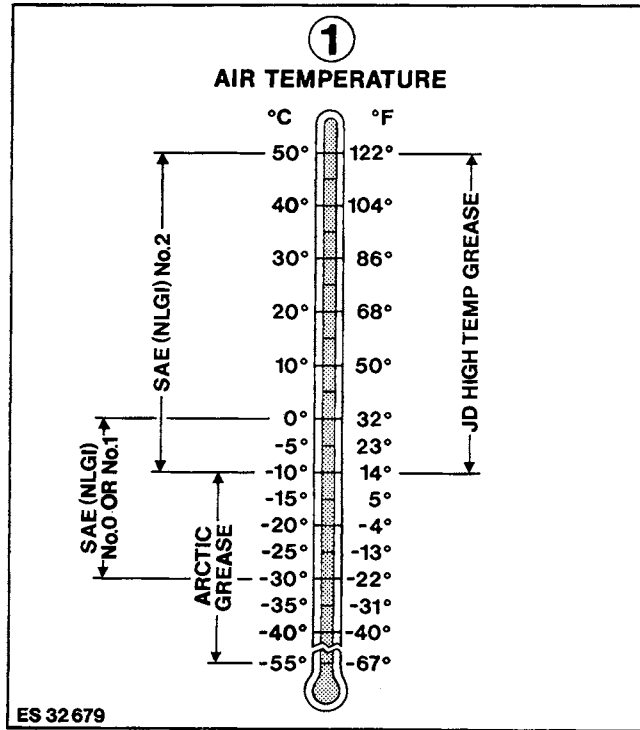

ES32679 Fig. 4 - Grease to be used at Expected Temperature

John Deere High Temperature EP Multipurpose Grease is recommended for all grease fittings. If other greases are used, use:

- SAE EP Multipurpose Grease

At temperature below  $-30^{\circ}\text{C}$  ( $-22^{\circ}\text{F}$ ) use Arctic Grease (MIL-G-10924 C).

Grease must be free of dust and other contamination.

Grease the tractor only when the engine is not running.

Clean grease fittings prior to greasing.

### Storing Lubricants

The tractor can operate at top efficiency only if clean lubricants are used. Use clean containers to handle all lubricants. Store them in an area protected from dust, moisture, and other contamination.

### Cooling Fluid

John Deere Engine Cooling Fluid is filled into the cooling system at the factory. It protects the engine against corrosion and against frost down to  $-36^{\circ}\text{C}$  ( $-35^{\circ}\text{F}$ ).

If no John Deere Engine Cooling Fluid is available use a mixture of 50% ethylene-glycol antifreeze anti-corrosion inhibitor and 50% clear, soft water. This mixture guarantees engine protection against corrosion and against frost down to  $-36^{\circ}\text{C}$  ( $-35^{\circ}\text{F}$ ).

Never use any cooling system sealing additives.

**IMPORTANT: Use only John Deere Cooling Fluid in the cooling system, independent of the season. Drain system and refill with fresh coolant every 2 years.**

### General Information

Carefully written and illustrated instructions are included in the tractor Operator's Manual. Remind your customer to follow the recommendations in these instructions.

For your convenience when servicing the tractor: the following chart shows capacities for the various components.

Component	Capacity	Service Interval
Engine crankcase	Without filter change: 8.0 liters (2.1 U.S. gal) With filter change: 8.5 liters (2.25 U.S. gal)	Every 10 operating hours: Check oil level Every 100 operating hours: Oil change Every 200 operating hours: Filter change*
Cooling system	Without SOUND-GARD Body 13.0 liters (3.4 U.S. gal) With SOUND-GARD Body 15.0 liters (4.0 U.S. gal)	Change coolant every two years
Transmission/Hydraulic system (including oil reservoir and oil cooler)		
Synchronized Transmission . . . . . Dry System:		
2350 . . . . .	59.0 L (15.6 U.S. gal)	Every 50 operating hours: Check oil level
2550 . . . . .	64.0 L (16.9 U.S. gal)	Every 500 operating hours: Filter change**
Oil change:		
2350 . . . . .	51.0 L (13.5 U.S. gal)	Every 1000 operating hours: Oil change
2550 . . . . .	56.0 L (14.8 U.S. gal)	Every 1000 operating hours: Change hydrostatic steering filter
Collar shift transmission (with Reverser)		
Dry System . . . . . 42.0 L (11.1 U.S. gal)		
Oil change . . . . . 34.0 L (9.0 U.S. gal)		
Every 1000 operating hours: Clean hydraulic pump stoke Control valve filter		

\*Replace crankcase filter elements after the first 100 hours and 200 hours of operation. Thereafter replace filter element after every 200 hours of operation.

\*\*Replace transmission/hydraulic filter element after the first 50 hours of operation, after the first 500 and thereafter every 500 hours of operation.

Component	Capacity	Service Interval
Auxiliary oil reservoir	4 L (1.1 U.S. gal) 2 L (0.5 U.S. gal)	
Mechanical front wheel drive	Axle housing 5.0 L (1.3 U.S. gal)  0.75 L (0.2 U.S. gal) each	Every 100 operating hours: Check oil level* Every 1000 operating hours: Oil change
Hydraulic operated clutch (On tractors with SOUND GARD Body)	500 cm <sup>3</sup> (17.5 fl. oz.)	Change brake fluid every year

\*On tractors with MFWD, first oil change after 100 hours of operation. Thereafter every 1000 hours of operation.

Component	Lubricant	Service Interval
Clutch throw-out bearing	John Deere High Temperature EP-multipurpose grease	Every 100 hours operating hours with three strokes of grease gun
Front wheel bearings	John Deere High Temperature EP multipurpose grease or SAE EP multipurpose grease	Every 1000 operating hours: Clean and pack with grease
Grease fittings		
Front axle and front wheels		Every 50 operating hours: Lubricate
(In wet and muddy conditions)		Every 10 operating hours: Lubricate
Universal-jointed shafts of mechanical front wheel drive		Every 50 operating hours: Lubricate
(In wet and muddy conditions)		Every 10 operating hours: Lubricate
Rear axle bearings		In extremely wet and muddy conditions; lubricate every 10 operating hours. Under normal conditions: lubricate every 500 operating hours.
Three-point hitch		Every 200 operating hours: Lubricate

## ENGINE CRANKCASE

### Checking Oil Level

With the tractor on level ground and the engine stopped for 10 minutes or more, check crankcase oil level. If the oil level is down to the lower mark on the dipstick, add sufficient John Deere TORQUE-GARD SUPREME engine oil or its equivalent of the proper viscosity to bring the level to the upper mark.

*Service Interval:* At predelivery and after every 10 hours.

### Oil and Filter Change

*NOTE: Drain oil with engine shut off, run engine to warm oil first.*

1. Remove drain plug.
2. While oil is draining, replace filter element (every 200 hours).
3. Remove filter element (turn counterclockwise) and clean mounting surface.

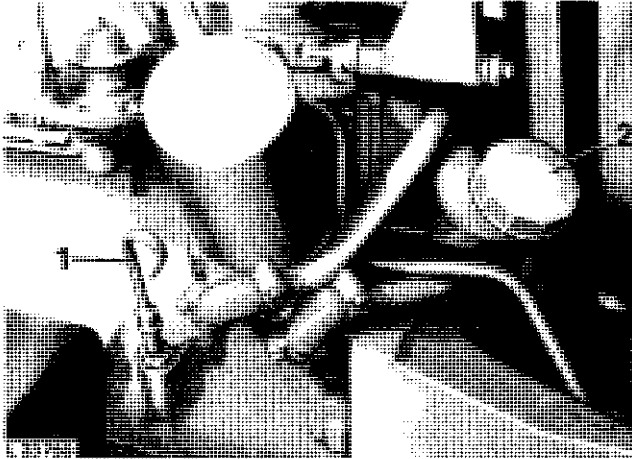

L28750

- 1—Dipstick  
2—Filler Cap

Fig. 5 - Engine Oil Dipstick and Filler Cap

4. Apply a thin film of oil to sealing ring of new filter. Tighten filter element until sealing ring touches mounting surface, then turn an additional 1/2 to 3/4 turns. Do not overtighten.
5. Reinstall drain plug.
6. Fill crankcase with fresh oil of the proper viscosity.

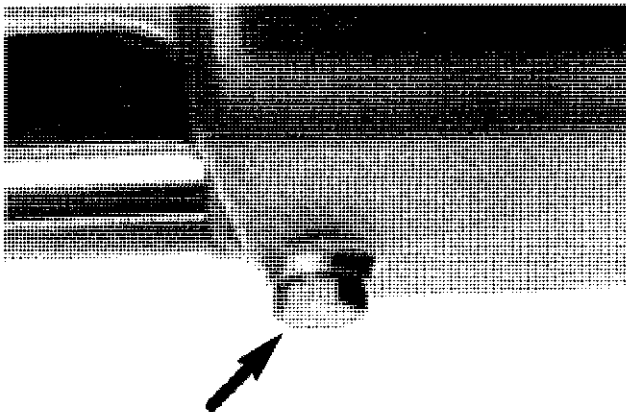

L 23999

L23999

Fig. 6 - Crankcase Drain Plug

7. Crankcase capacity without filter change 8.0 L (2.1 U.S. gal), with filter change 8.5 L (2.25 U.S. gal).
8. Run engine for a short time and check for leaks at filter base and drain plug.

9. Stop engine.
10. Check oil level.

**IMPORTANT:** During cold weather operation with temperature below freezing point, change oil every 100 hours or every six weeks, whichever occurs first. Also change oil at any seasonal change in temperature when oil of a new viscosity is required.

*Service Interval:* Every 100 hours.

## Transmission/Hydraulic System

### CHECKING OIL LEVEL

1. With the tractor on level ground, run the engine 2 to 3 minutes.
2. Place range and gear shift lever in neutral position.
3. Apply handbrake.
4. Lower draft links.
5. Run engine at slow idle (700 to 800 rpm).

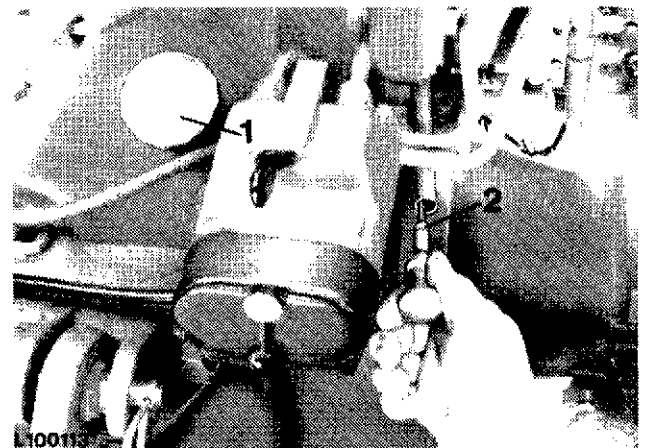

L100113

L100113

- 1—Filler Cap  
2—Dipstick

Fig. 7 - Transmission/Hydraulic System Dipstick and Filler Cap  
(On tractors with synchronized transmission)

6. Pull out dipstick and wipe clean.
7. Insert dipstick. Remove dipstick and check oil level.
8. If necessary, add John Deere HY-GARD transmission and hydraulic oil or equivalent oil to bring oil level to top mark on dipstick.

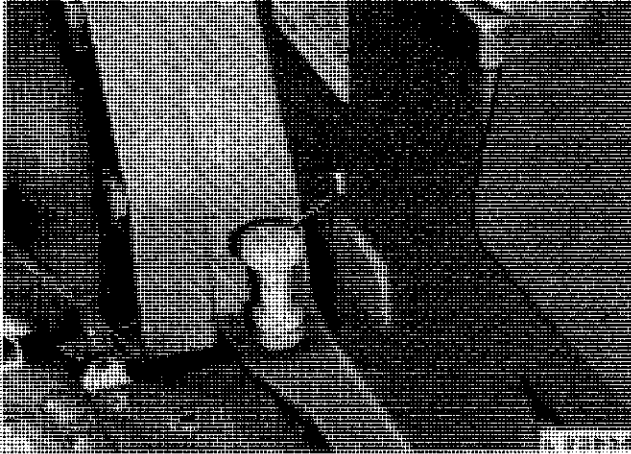

L23934

Fig. 8 - Transmission/Hydraulic System Dipstick (on tractors, with collar shift transmission)

**NOTE:** Types of oil not meeting our specifications will not give satisfactory service and may result in eventual damage.

**Service Interval:** At predelivery and every 50 hours.

**FILTER CHANGE**

**Transmission/Hydraulic Oil Filter**

1. Disconnect selective control valve return line at transmission oil filter port.
2. Remove retaining screws (3, Fig. 9) and lift out filter cover (2).

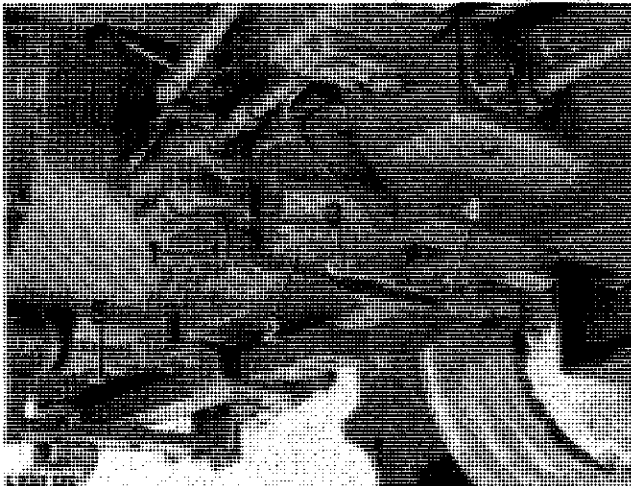

L100120

- |                   |                    |
|-------------------|--------------------|
| 1—Plug            | 4—Front Drain Plug |
| 2—Filter Cover    | 5—Rear Drain Plug  |
| 3—Retaining Screw |                    |

Fig. 9 - Transmission/Hydraulic Oil Filter

3. Remove element and packing.

4. Install new packing coated with grease in transmission case groove.
5. Insert new element and reinstall filter cover (2, Fig. 9).
6. Tighten retaining screw 3 to 75 N·m (55 lb-ft) torque.
7. Connect selective control valve return line at transmission oil filter port.

**Service Interval:** After the first 50, after the first 500 and thereafter every 500 hours of operation.

**Hydrostatic Steering Filter (Tractors Without SOUND-GARD Body)**

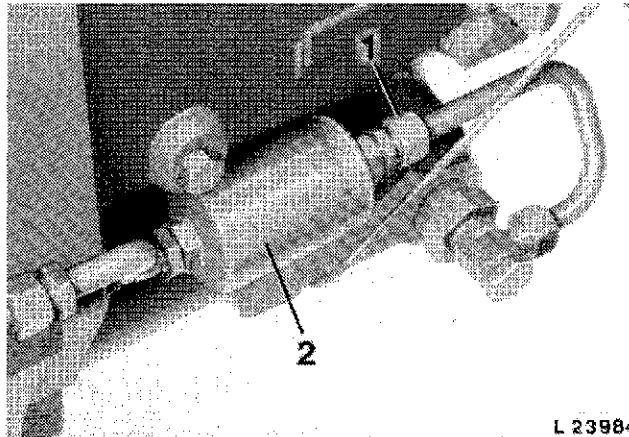

L23984

L 23984

- |             |
|-------------|
| 1—Union Nut |
| 2—Filter    |

Fig. 10 - Hydrostatic Steering Filter

1. Remove union nut (1, Fig. 10) from return line.
2. Unscrew filter (2) out of line.
3. Install new filter and tighten union nut.

**Service Interval:** Every 1000 hours.

**OIL CHANGE**

1. Start engine and operate hydraulic functions to heat transmission oil to operating temperature.
2. Shut off engine.
3. Remove drain plugs (4 and 5, Fig. 9).

**NOTE:** On tractors with MFWD, also remove drain plug (1, Fig. 11) from clutch housing.

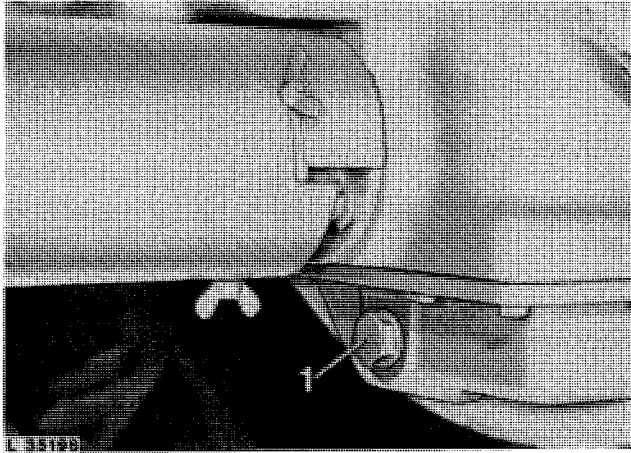

L35198

**1—Drain Plug***Fig. 11 - Clutch Housing Drain Plug (On Tractors with MFWD)*

4. Replace transmission/hydraulic system filter element (see Filter Change).
5. Remove plug (1, Fig. 9), pull out intake screen and wash in fuel.
6. *On tractors without SOUND-GARD body*, replace hydrostatic steering filter (2, Fig. 10), (see Filter Change).
7. Remove hydraulic pump filter screen and clean. Reinstall filter screen and tighten plug.
8. Before filling with fresh oil, reinstall intake screen. Reinstall drain plugs and tighten to 135 N·m (100 lb-ft) torque. Use new seal rings.
9. Refill system with transmission/hydraulic oil to top mark on dipstick.
10. Run engine for 2 to 3 minutes, then recheck oil level.
11. Check oil level with engine running at slow idle, tractor standing on level ground, transmission in neutral, lift arms lowered and clutch engaged.

**Service Interval:** Every 100 hours.

## Mechanical Front Wheel Drive

### CHECKING WHEEL HUB HOUSING OIL LEVEL

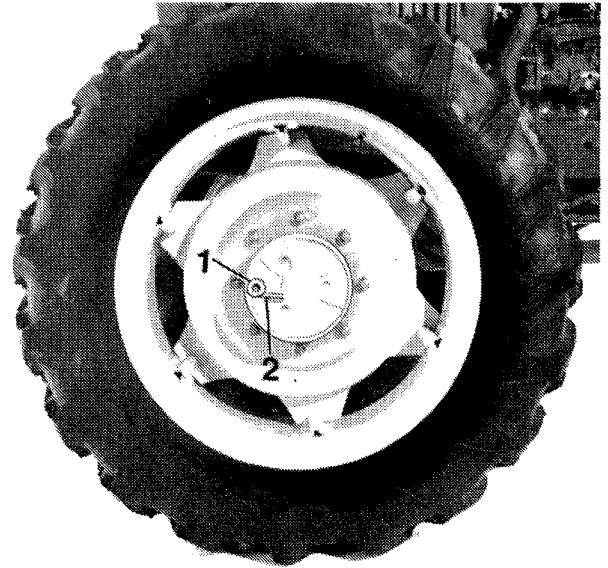

L 35198

L354196

**1—Level Plug  
2—Oil Level Mark***Fig. 12 - Checking Wheel Hub Housing Oil Level*

1. Turn wheel until mark (2, Fig 12) is in level position.
2. Remove level plug (1). Oil should be level with plug bore.
3. Add oil, if necessary, using EP transmission oil according to specifications (see page 2).

### CHECKING AXLE HOUSING OIL LEVEL

1. Remove level plug (1, Fig. 13). Oil should be level with plug bore.
2. If necessary, top up with oil, using EP transmission oil according to specifications (see page 2).

**Service Interval:** Every 100 hours.

## AXLE HOUSING OIL CHANGE

1. Remove drain plug (2, Fig. 13) and drain oil.
2. Reinstall drain plug and tighten securely.
3. Remove filler plug. Fill with fresh oil (5.0 L; 1.3 U.S. gal) up to level of plug bore. Reinstall filler plug.

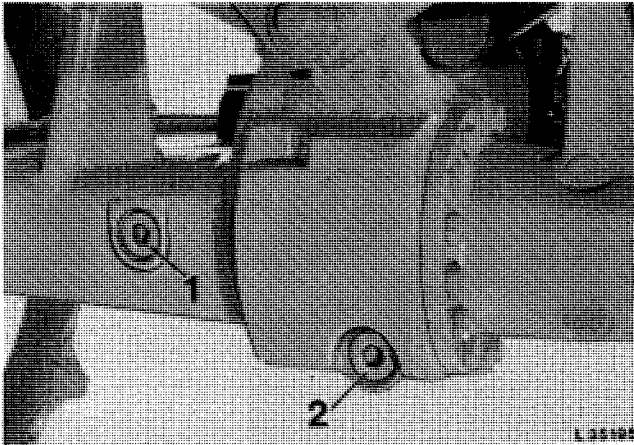

L35195

- 1—Level Plug  
2—Drain Plug

Fig. 13 - Checking Axle Housing Level

## Wheel Hub Housing Oil Change

1. Turn wheel until level plug (1, Fig. 12) is at the bottom. Remove plug and drain oil.
2. Turn wheel until mark (2, Fig. 12) is in level position.
3. Fill with fresh oil (0.75 L; 0.20 U.S. gal) through level plug bore. Use EP transmission oil according to specifications on page 2
4. Check oil level. Reinstall level plug and tighten securely.

**NOTE:** Drain oil immediately after having operated the tractor for some time when the oil is still warm.

**Service Interval:** Change oil every 1000 hours.

## Front Wheel Bearings

### CLEANING AND PACKING BEARINGS

1. Jack up front axle.
2. Remove hub cap. Remove cotter pin and slotted nut.
3. Disassemble parts. Clean parts in solvent and blow them dry with compressed air.
4. Inspect parts carefully for damage. Replace bearings if they are worn. Replace oil seal and oil seal cup if grooves are worn in cup.
5. Pack bearings with John Deere EP-multipurpose grease or SAE EP multipurpose grease. Coat seal with EP multipurpose grease or its equivalent.
6. Reassemble parts. Tighten parts. Tighten slotted nut until a slight drag is felt when wheel is turned. Back nut off just enough to insert cotter pin in first hole.
7. Reinstall hub cap.

**Service Interval:** Every 1000 hours.

### Lubricating Points

**IMPORTANT:** Thoroughly clean all grease fittings prior to greasing and replace damaged grease fittings immediately.

#### CLUTCH THROW-OUT BEARING (When equipped with grease fittings)

Lubricate clutch throw-out bearing with three strokes on grease gun. Always use John Deere high temperature EP multipurpose grease.

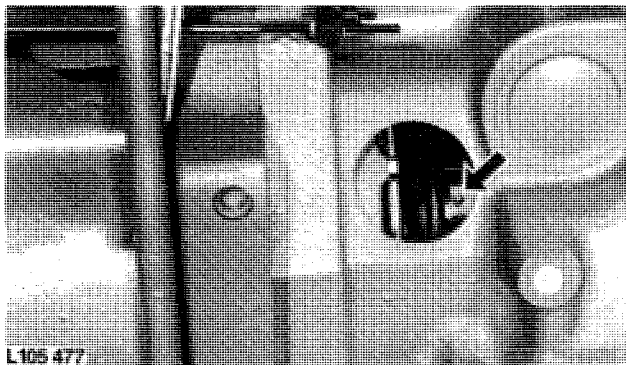

L105477

Fig. 14 - Throw-Out Bearing Grease Fitting  
(Tractor without SOUND-GARD Body Shown)

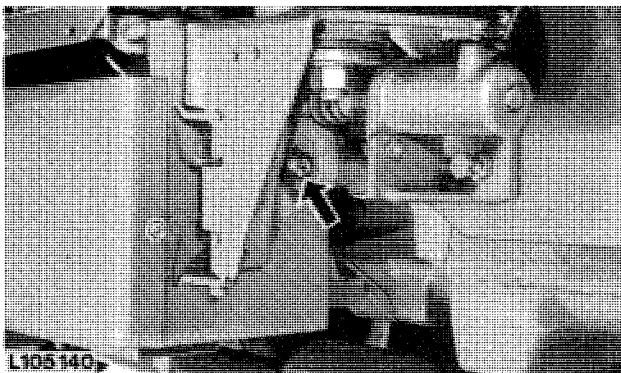

L105140

Fig. 15 - Throw-Out Bearing Grease Fitting  
(Tractor with SOUND-GARD Body Shown)

**Service Interval:** Every 100 hours.

Lubricate grease fittings shown in Figs. 16 to 20. Use John Deere EP multipurpose grease.

### LUBRICATING FRONT AXLE AND FRONT WHEELS (TRACTORS WITHOUT FRONT WHEEL DRIVE)

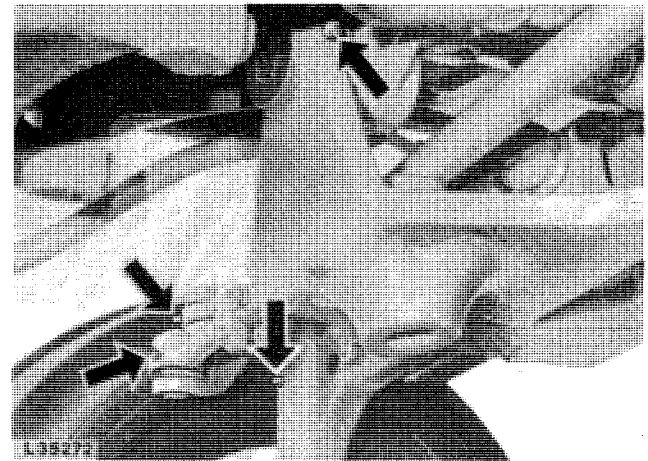

L35272

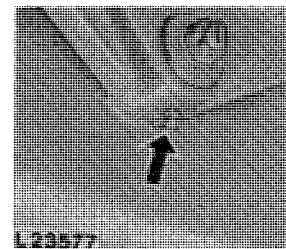

L23577

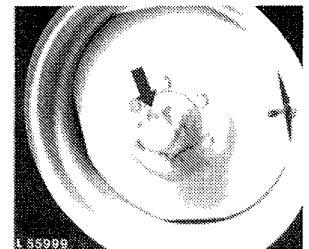

L55999

Fig. 16 - Front Axle and Front Wheel Grease Fittings

**Service Interval:** At predelivery, when operating in wet and muddy conditions every 10 hours, otherwise every 50 hours.

### LUBRICATING FRONT AXLE (TRACTORS WITH MFWD)

#### Mechanical Front Wheel Drive

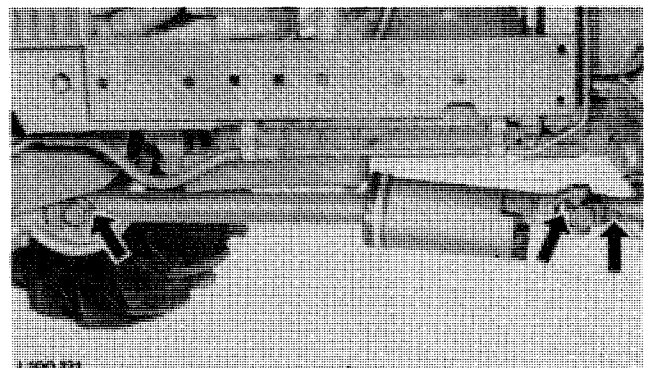

L100121

Fig. 17 - Jointed Drive Shaft Grease Fittings

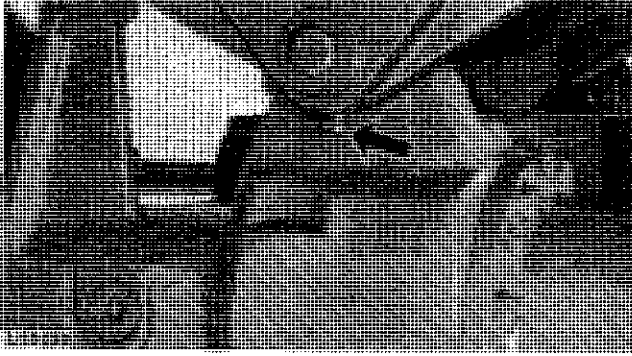

L35230

Fig. 18 - Front Axle Carrier Grease Fitting

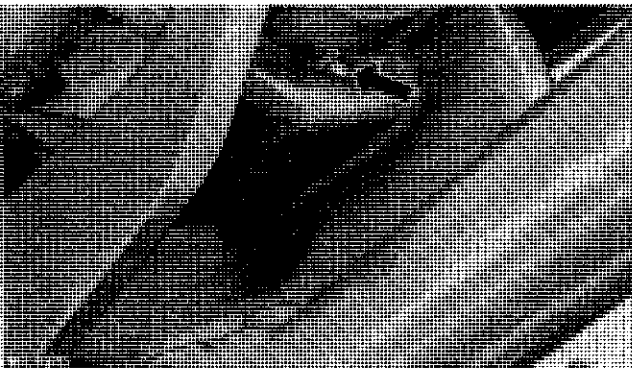

L36231

Fig. 19 - Oscillating Support Grease Fitting

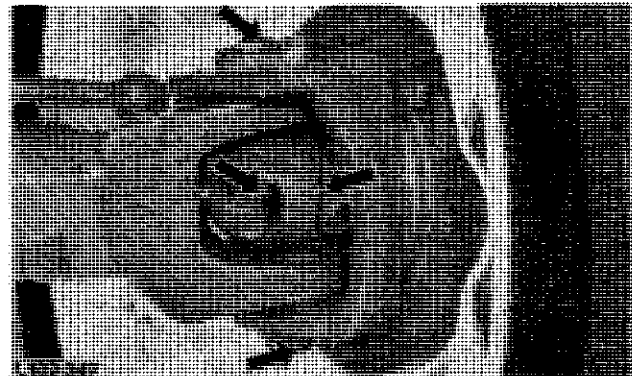

L102347

Fig. 20 - Front Axle Grease Fittings

**Service Interval:** At predelivery, when operating in wet and muddy conditions every 10 hours, otherwise every 50 hours.

## LUBRICATING THREE-POINT HITCH

1. Lubricate lift link oiler (1, Figs. 21) using engine oil.
2. Lubricate lift link grease fittings with several strokes of grease gun, using John Deere EP multipurpose or SAE Ep multipurpose grease.

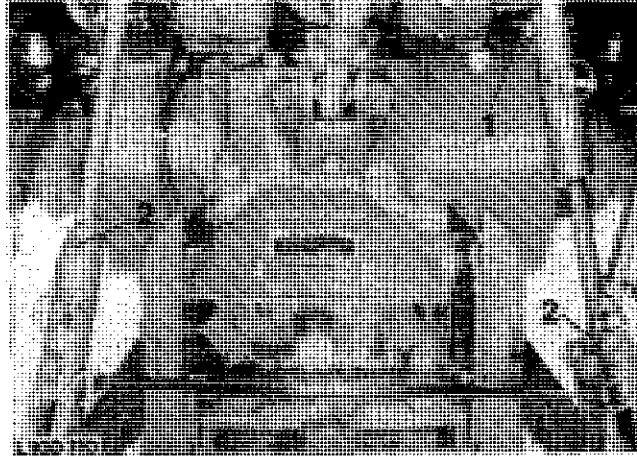

L100110

- 1—Oiler  
2—Grease Fittings

Fig. 21 - Lift Link Grease Fittings  
(Tractor with SOUND-GARD Body Shown)

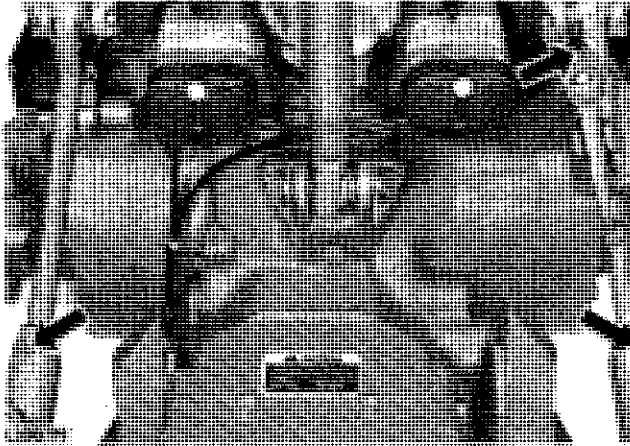

L100111

*Fig. 22 - Lift Link Grease Fittings  
(Tractors Without SOUND-GARD Body)*

**Service Interval:** Lubricate every 200 hours.

#### **LUBRICATING REAR AXLE BEARINGS**

Lubricate both bearings with 6 to 8 stokes of grease gun, using John Deere EP multipurpose grease or SAE EP multipurpose grease.

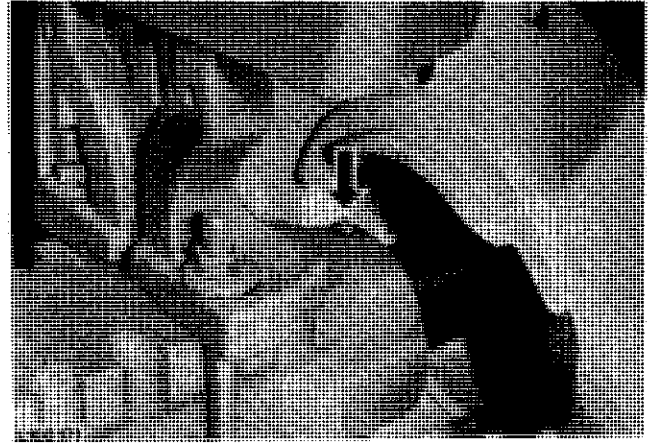

L100171

*Fig. 23 - Rear Axle Grease Fitting*

**Service Interval:** Every 10 hours (only when operating in extremely wet and muddy conditions) and every 500 hours.



## Group 15 TUNE-UP

### PRELIMINARY ENGINE TESTING

Before tuning up a tractor, determine whether a tune-up will restore operating efficiency. When there is doubt, the following preliminary tests will help to determine if the engine can be tuned-up. Choose from the following procedures only those necessary to restore the unit.

1. After engine has been stopped for several hours, carefully loosen crankcase drain plug and watch for any water to seep out. A few drops could be due to condensation, but any more than this would indicate problems which require engine repairs rather than just a tune-up.
2. With engine stopped, inspect engine coolant for an oil film. With engine running, inspect coolant for air bubbles. Either condition would indicate problems which require engine repairs rather than just a tune-up.
3. Perform a dynamometer test and record horsepower. Repeat dynamometer test after tune-up, so horsepower output before and after tune-up can be compared.
4. Perform compression test as instructed on page 2.

### DYNAMOMETER TEST

If possible, test the engine on a dynamometer before it is tuned. This test gives the horsepower output and fuel consumption of the engine as it is. This will help determine if a tune-up can restore the engine or whether an overhaul is needed.

Good performance by the engine depends on these basic things:

1. An adequate supply of clean air and fuel.
2. Good compression.
3. Proper valve and injection pump timing for good combustion.
4. Proper air and fuel temperatures.

Make the dynamometer test as follows:

1. Connect the engine to the dynamometer using the manufactures instructions.
2. Operate the engine at one-half load until the coolant and crankcase oil temperature are up to normal.
3. Run engine at fast idle (2610 to 2660).
4. Gradually increase the load on the engine until its speed is reduced to 2500 rpm.
5. Read the horsepower on the dynamometer.
6. Compare the reading taken with the following specifications:

PTO horsepower\* at 2500 rpm rated engine speed (PTO speed 565 or 1040 rpm):

According to SAE J 816b

2350 .....	41 kW 55 hp
2550 .....	48 kW 65 hp

\*With engine run in (more than 100 hours of operation) and having reached operating temperature (engine and transmission); measured by means of a dynamometer. Permissible variation ± 5 per cent.

## TESTING COMPRESSION PRESSURE

*NOTE: Before beginning test, insure that batteries are fully charged.*

**IMPORTANT: Thoroughly clean area around injection nozzles.**

1. Remove fuel pressure and fuel tank leak-off lines from injection nozzles.
2. Remove injection nozzles.
3. Install special tools 19.58-90.578\* (Fig. 1) in injection nozzle bore.
4. Connect compression tester FKM 10022\* with hose FKM 10024\* to special tool 19.58-90.578\* (see Fig. 1).
5. Connect terminals (4) of compression tester to starter terminals (30 and 50) (see 3 and 5, Fig. 1).
6. Disconnect injection pump shut-off lever spring and move shut-off lever forward to stop.
7. Turn engine by means of starter button (1) until compression tester registers no further rise in pressure.
8. When cranking engine by means of starter, compression reading should be at least 2100 kPa (21 bar) (300 psi). (Engine starting motor and batteries in good condition).

*NOTE: It is a good practice to count the number of compression strokes (indicated by movement of the gauge needle) and check each cylinder with the same number of strokes. The engine must be at full cranking speed to get a good reading.*

9. If pressure is much lower than specified above, remove special tool 19.58-90.578\* and apply oil to the ring area of piston through injection nozzle hole. Do not use too much oil. Do not get oil on the valves.

\*Part of compression test kit FKM 10021

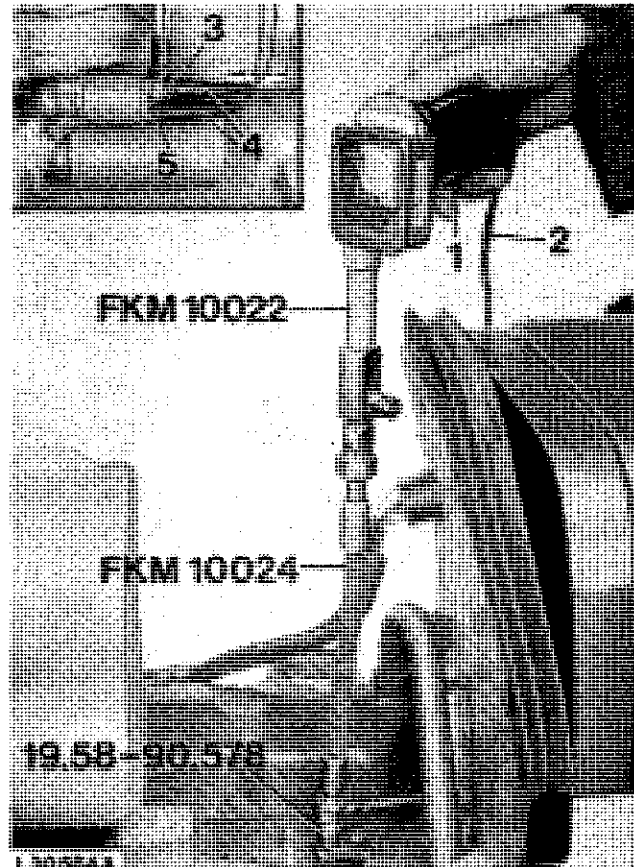

L30564A

- 1—Starter Button
- 2—Cable
- 3—Terminal 30
- 4—Compression Tester Terminals
- 5—Terminal 50

Fig. 1 - Measuring Compression Pressure

10. Test compression again. If pressure is higher, worn or stuck piston rings are indicated. If the pressure is still low, it is possible that valves are worn or sticking.

**IMPORTANT: It is very important that all cylinder pressures be approximately alike. There should be less than 350 kPa (3.5 bar) (50 psi) difference between cylinder pressures.**

*NOTE: Altitude affects compression pressures. Normally there is about a 4 per cent loss every 300 m (1000 ft.) of altitude above sea level. Pressure given is for about 300 m (1000 ft.) above sea level.*

## ENGINE TUNE-UP

### Air Intake System

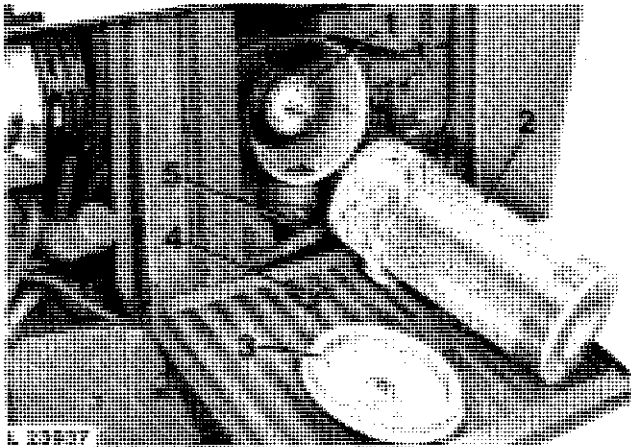

L23937

- |                       |                        |
|-----------------------|------------------------|
| 1—Safety Element      | 4—Wing Nut             |
| 2—Air Cleaner Element | 5—Dust Unloading Valve |
| 3—Cover               |                        |

Fig. 2 - Air Cleaner and Safety Element

### Dusting Element

1. Check air cleaner element (2, Fig. 2). If dirty, tap it on the palm of your hand.
2. If tapping element does not remove dust, blow out dust with compressed air. Pressure not to exceed 600 kPa (6 bar) (85 psi) by inserting nozzle inside of element and blowing from the inside of the filter to the outside.

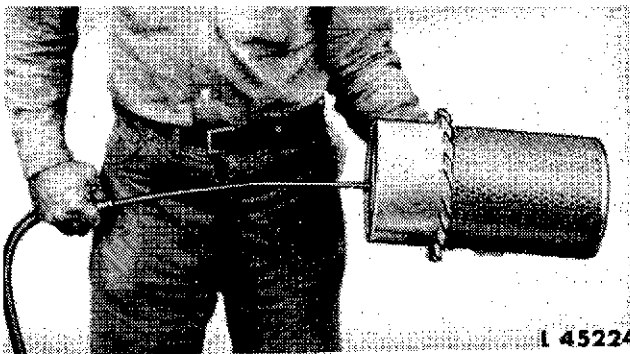

L45224

Fig. 3 - Cleaning Air Cleaner Element by Means of Compressed Air

### Oil or Sooty Element

**IMPORTANT:** Never wash element in fuel oil, gasoline or strong cleaning agent. Never use compressed air to dry element. Compressed air will rupture a wet element.

1. Wash element in a solution of lukewarm water and a mild nonsudsing detergent. Rinse element thoroughly from the inside with clean water (water pressure not above 300 kPa 3 bar 43 psi). Shake water from element and dry for approximately 24 hours at a temperature of 20°C (70°F).

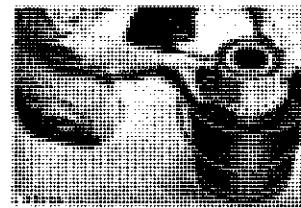

L45225

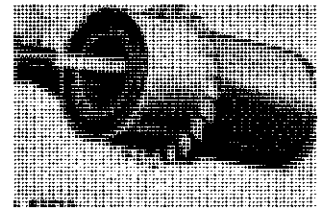

L45225

Fig. 4 - Wet Cleaning

2. After cleaning the element, inspect it by placing a bright light inside the filter. Discard any filter that shows the slightest rupture, indicated by light through the hole. Make sure gasket is in a serviceable condition.

**IMPORTANT:** Replace filter element after six cleanings or one year of service, whichever occurs first.

3. When servicing the air cleaner always remove and clean the rubber dust unloading valve.
4. The valve must always be installed with slot facing direction of travel.

**IMPORTANT:** Do not operate engine without air cleaner element or rubber dust unloading valve installed.

### Air Cleaner Secondary (Safety) Element

1. This filter element must be changed annually, when clogged or damaged and with every third service of air cleaner primary element.

2. Should it become necessary to clean primary filter element more often than usual, this is a sign that the secondary (safety) filter must be replaced.

**IMPORTANT: Always replace secondary (safety) filter element, do not attempt to clean.**

### Air Intake Connections

Check all connections in air intake system of possible leaks. Tighten any loose clamps. Be sure rubber dust unloading valve is in good condition.

### Measuring Air Intake System Vacuum

1. Clean air cleaner.
2. Remove left-hand radiator grille screen.
3. Run engine until it has reached normal operating temperature.
4. Remove plug or burner (when equipped with thermostart cold weather starting aid) or starting fluid line at intake support (when equipped).
5. Install and tighten connector 0753 NU\* in bore now free.
6. Using connector KFM 10302\*, pressure hose FKM 10209\* and connector FKM 10303\*, attach vacuum gauge FKM 10242 to connector 0753 NU\*.
7. Run engine at 2610 to 2660 rpm.

\* Part of testing kit KFM 10002 which is an alternate tool for Canada. Otherwise use D-05022 ST.

8. With a clean element installed, vacuum should be approx. 3.5 kPa (35 mbar; 14 in. water head), but never exceed 6 kPa (60 mbar; 25 in. water head). If this is the case, there is a restriction in the air intake system. Correct the problem.

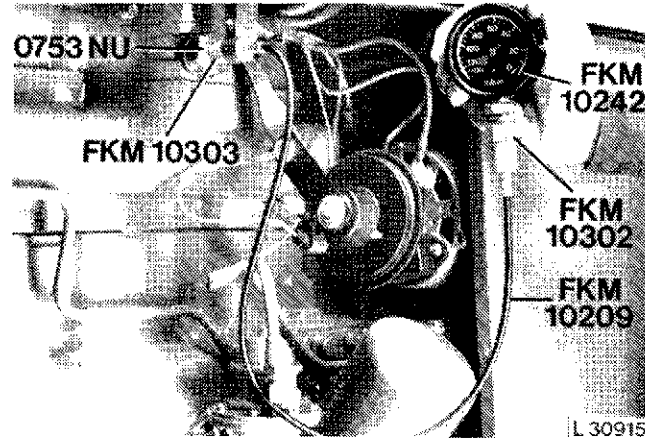

L30915

Fig. 5 - Measuring Air Intake System Vacuum

9. Also check air cleaner restriction warning switch.
10. Run engine at 2500 rpm. Use a piece of cardboard to partially cover air cleaner intake. Increase the restriction until air cleaner indicator light goes on, and note vacuum reading.
11. Air cleaner restriction warning switch should close at a vacuum of 5.5 to 6.5 kPa (55 to 65 mbar; 22 to 26 in. water head). If not, replace switch.

### Exhaust System

Inspect exhaust system for any leaks or restrictions. Correct as necessary.

### Measuring Blow-by

1. Place a hose with a standard gas gauge over end of crankcase vent tube.

2. Run engine at rated speed (2500 rpm). (Engine at operating temperature and run-in, with at least 100 operating hours).

3. Measure blow-by over a period of 5 minutes. Multiply figure obtained by 12 (hourly rate) and check against specified figure:

2350 .....	2.5 m <sup>3</sup> /h
	88 cu. ft./h
2550 .....	2.7 m <sup>3</sup> /h
	95 cu. ft./h

4. If blow-by is lower, there is no undue wear between piston rings and liners. As a further check, carry out compression test. If blow-by is higher, there is excessive wear between piston rings and liners, resulting in loss of engine power. Overhaul engine.

**Crankcase Vent Tube**

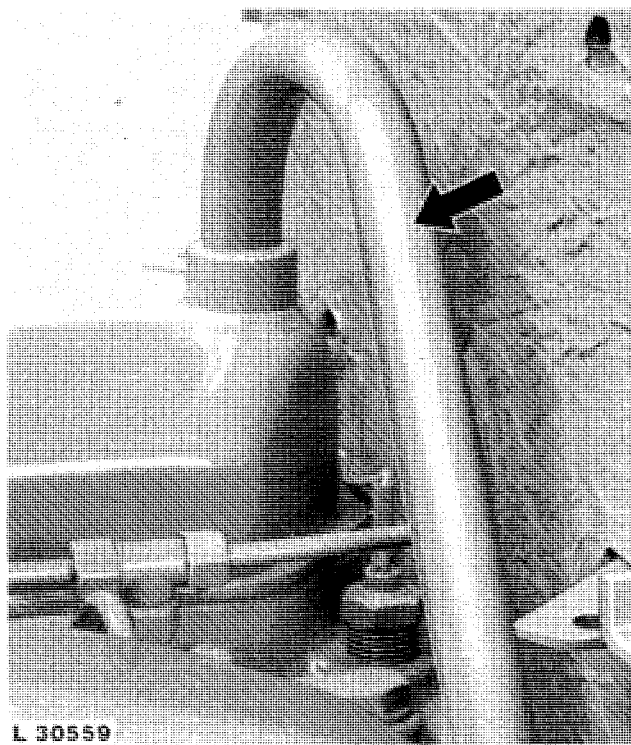

L30559

Fig. 6 - Crankcase Vent Tube

1. Inspect crankcase vent tube for restriction. Lack of ventilation causes sludge to form in engine crankcase. This can lead to clogging of oil passages and filters, resulting in serious engine damage.

2. If necessary, clean vent tube in solvent.

**Cooling System**

**Cleaning Radiator**

1. Clean radiator grille screens, if necessary.

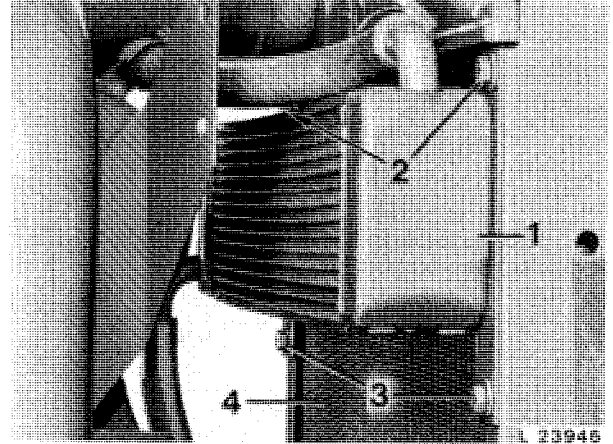

L23946

- 1—Oil Cooler
- 2—Cap Screws
- 3—Cap Screws
- 4—Radiator

Fig. 7 - Radiator and Oil Cooler

2. Clean radiator and oil cooler. To clean portion of radiator behind oil cooler, remove cap screws (2 and 3, Fig. 7).

**Flushing Cooling System**

1. Drain cooling system by opening drain cocks on radiator and engine block.

2. Turn SOUND-GARD Body heater (if equipped) on and leave it on until finished.

3. Close drain cocks and fill cooling system with clean water.

4. Run engine until it reaches operating temperature to stir up possible rust or sediment.



**Suggest:**

**If the above button click is invalid.**

**Please download this document**

**first, and then click the above link**

**to download the complete manual.**

**Thank you so much for reading**



L30560

- 1—Engine Block Drain Cock
- 2—Radiator Drain Cock

Fig. 8 - Cooling System Drain Cocks

**Checking Radiator for Leaks**

1. Remove radiator.
2. Install radiator cap plug top connection.
3. Attach compressed air hose to bottom connection.
4. Submerge radiator in clean tank filled with clear water.
5. Apply 50 kPa (0.5 bar) (7 psi) pressure to radiator and check whether this pressure is maintained. If not, correct the problem.

*NOTE: Radiator repairs should only be made in specialized repair shops.*

**Radiator Cap**

1. Check radiator cap, rubber seal and spring for serviceability. The seal must fit tightly and feel soft.
2. Using a commercially available special tester, check whether high pressure valve can hold a pressure of 40 to 50 kPa (0.4 to 0.5 bar) (6 to 7 psi) or opens at a higher pressure.
3. Low pressure valve should open between 0 to 4 kPa (0.04 bar) (0.6 psi). Replace radiator cap, if necessary.

5. Stop engine and drain coolant before rust or sediment settles.

6. Close drain cocks and fill cooling system with a solution of John Deere cooling system cleaner or its equivalent and water. Follow the instructions with the cleaner.

7. After cleaning, flush the system with clean water.

8. Fill cooling system with clean, soft water and antifreeze. Use a permanent type, ethylene glycol antifreeze which contains a rust inhibitor but does not contain a stop-leak additive.

9. Recheck coolant level after starting engine. Coolant level should be midway between the filler neck and top of radiator core.

10. Cooling system capacity:

Without SOUND-GARD Body .....	13 L
	3.4 U.S. gal.
With SOUND-GARD Body .....	15 L
	3.95 U.S. gal.

**<https://www.ebooklibonline.com>**

Hello dear friend!

Thank you very much for reading.

Enter the link into your browser.

The full manual is available for immediate download.

**<https://www.ebooklibonline.com>**