

**2155 and
2355N Tractors
- Repair -**

**TECHNICAL
MANUAL**

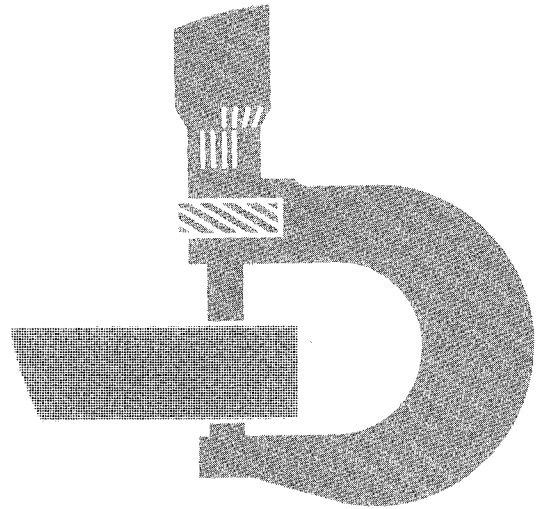

Introduction

FOREWORD

This manual is written for experienced technicians. Essential tools required to perform certain service operations are identified in this manual and are recommended for use.

Live with safety: Read the safety messages on the first pages of this manual as well as the cautions presented throughout the text of the manual.



This is the safety alert symbol. When you see this symbol on the machine or in this manual, be alert to the risk of personal injury.

Information is organized in groups for the various components requiring service instruction. At the beginning of each group are summary listings of all applicable essential tools, service equipment and tools, other materials needed to do the job, service parts kits, specifications, wear tolerances and torque values.

Binders, binder labels and tab sets can be ordered by John Deere dealers direct from the John Deere Distribution Service Center.

This manual is part of a total product support program.

FOS Manuals – Reference

Technical Manuals – Machine service

Component Technical Manuals – Component service

Fundamentals of Service (FOS) Manuals cover basic theory of operation, fundamentals of troubleshooting, general maintenance and the basic types of failures and their causes. FOS Manuals are for the training of new personnel and for reference by experienced technicians.

Technical Manuals are concise guides for specific machines. Technical Manuals are on-the-job guides containing only the vital information needed for diagnosis, analysis, testing and repair.

Component Technical Manuals are concise service guides for specific components. Component technical manuals are written as stand-alone manuals covering multiple machine applications.

The following Component Technical Manuals will be required to properly service these tractors:

- CTM-4, 300 Series Engines
- CTM-4422, MFWD Axles

Contents

2155 AND 2355 N TRACTORS TECHNICAL MANUAL TM4435 (DEC-89)

SECTION CONTENTS IN GROUPS – REPAIR

05 – SAFETY

10 – GENERAL

- 05 – Specifications
- 10 – Predelivery, delivery and after-sales inspections
- 15 – Lubrication and service
- 20 – Tune-up
- 25 – Tractor separation

20 – ENGINE

- 05 – Radiator, viscous fan drive and fan

30 – FUEL AND AIR INTAKE SYSTEM

- 05 – Fuel tank and water trap
- 10 – Cold weather starting aids
- 15 – Speed control linkage
- 20 – Air cleaner

40 – ELECTRICAL SYSTEM

- 05 – Wiring harnesses
- 10 – Controls and instruments
- 15 – Lighting system
- 20 – Starting motor
- 25 – Alternator

50 – POWER TRAIN

- 05 – Clutch operating systems
- 10 – Engine single-stage clutch (without Reverser)
- 15 – Engine single-stage clutch (with Reverser)
- 20 – Engine dual-stage clutch
- 25 – Hi-Lo shift unit
- 30 – Reverser
- 35 – Creeper transmission
- 40 – Transmission – center shift
- 45 – Synchronized transmission and transmission oil pump
- 50 – Collar-shift transmission and transmission oil pump
- 55 – Differential
- 60 – Final drives
- 65 – Independent PTO shafts
- 70 – Continuous-running PTO's
- 75 – Front wheel drive u.j. drive shaft and disk clutch

60 – STEERING SYSTEM AND BRAKES

- 05 – Power steering
- 10 – Hydraulic brakes
- 15 – Handbrake

70 – HYDRAULIC SYSTEM

- 05 – Valves
- 10 – Hydraulic pumps
- 15 – Rockshaft
- 20 – Selective control valves (spool type)
- 25 – Selective control valves (poppet valve type)

COPYRIGHT © 1989 DEERE & Co.
European Office Mannheim
All rights reserved
A John Deere ILLUSTRATION™ Manual
PREVIOUS EDITIONS
COPYRIGHT © 1987

INHALT-LB801AE-010489

<https://www.ebooklibonline.com>

Hello dear friend!

Thank you very much for reading.

Enter the link into your browser.

The full manual is available for immediate download.

<https://www.ebooklibonline.com>

SECTION CONTENTS IN GROUPS – REPAIR

70 – HYDRAULIC SYSTEM (CONTD.)

- 30 – ISO breakaway couplers
- 35 – ISO quick couplers
- 40 – Remote cylinder







80 – MISCELLANEOUS

- 05 – Front axle
- 10 – Front and rear wheels

90 – OPERATOR'S STATION

- 05 – Operator's seats
- 10 – 2-post ROLL-GARD
- 15 – 2-post telescopic ROLL-GARD

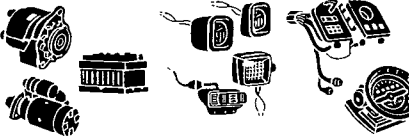
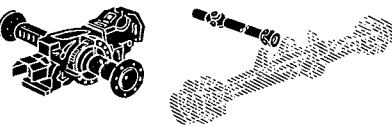
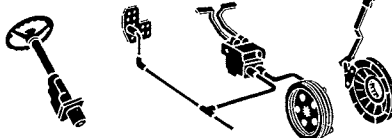
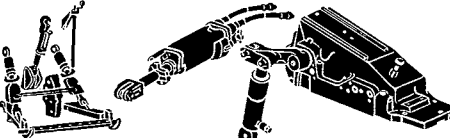
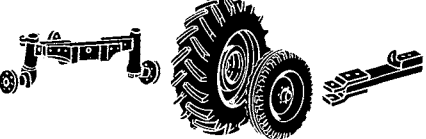
INHALT-LB802AE-010787

<p>SAFETY</p>		<p>05</p>
<p>GENERAL</p>		<p>10</p>
<p>ENGINE</p>		<p>20</p>
<p>FUEL AND AIR INTAKE SYSTEM</p>		<p>30</p>
<p>ELECTRICAL SYSTEM</p>		<p>40</p>
<p>POWER TRAIN</p>		<p>50</p>
<p>STEERING SYSTEM AND BRAKES</p>		<p>60</p>
<p>HYDRAULIC SYSTEM</p>		<p>70</p>
<p>MISCELLANEOUS</p>		<p>80</p>
<p>OPERATOR'S STATION</p>		<p>90</p>

FX 100 000 19

SAFETY AND YOU

This is the safety-alert symbol. When you see this symbol on the machine or in this manual, be alert to the potential for personal injury.



T 81389

T81389;053;TMSAFE 19 07OCT85

IMPORTANT

The IMPORTANT message identifies potential problems which may cause consequential damage to machine. Following recommended procedure will instruct technician how to avoid problem.

A68;N01;0000 19 U 05NOV82

NOTES

The word NOTE is followed by a statement that identifies a qualification or exception to a previous statement. A "NOTE" may also identify nice-to-know information pertinent to, but not directly related to previous statement.

A68; N01;0000 19 V 05NOV82



OBSERVE SAFETY RULES

Avoid loose clothing that can catch in moving parts and put you out of work.

Wear your safety glasses while on the job.

Avoid working on equipment with the engine running. If it is necessary to make checks with the engine running, **ALWAYS USE TWO PEOPLE** – with the operator, at the controls, able to see the person doing the checking. Also, put the transmission in neutral, set the brake, and apply safety locks provided. **KEEP HANDS AWAY FROM MOVING PARTS.**

Keep transmission and brake control units properly adjusted at all times. Before making adjustments, stop engine.

Before removing any housing covers, stop engine. Take all objects from your pockets which could fall into the opened housings. Don't let adjusting wrenches fall into opened housings.

Don't attempt to check belt tension while the engine is running.

Don't adjust the fuel system while the machine is in motion.

Before repairing the electrical system, or performing a major overhaul, make sure the batteries are disconnected.

A68; N01;0000 19 S 05NOV82

PREPARE FOR EMERGENCIES

Be prepared if a fire starts.

Keep a first aid kit and fire extinguisher handy.

Keep emergency numbers for doctors, ambulance service, hospital and fire department near your telephone.

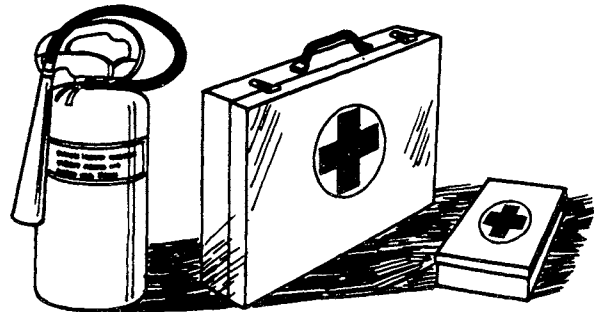

L 114 052

L114052;053;FIR2 19 15MAR89

DELIVERY INSPECTION

A thorough discussion of the operation and service of the tractor at the time of its delivery helps to assure complete customer satisfaction with his JOHN DEERE tractor.

Proper delivery should therefore be an important part of the dealer's program.

It is a well-known fact that many complaints have arisen simply because the owner was not shown how to operate and service his new tractor properly. Therefore, enough time should be devoted, at the customer's convenience, to introducing him to his new tractor and explaining to him how to operate and service it.

Using the tractor operator's manual as a guide, be sure that the owner understands the following points properly:

1. The importance of the safety rules.
2. Operation of control levers and instruments.
3. Starting and shutting off the engine.

4. The importance of the tractor break-in period.

5. Use of counterweights and proper tire inflation pressure as well as filling of tires with water and calcium chloride, if required.

6. All functions of the hydraulic system.

7. Operating the PTO.

8. The importance of lubrication and periodic service.

Give particular emphasis to sway blocks, rockshaft rate-of-drop, rockshaft selector lever (load and depth control), transmission oil pressure indicator light, engine oil pressure indicator light (high oil temperature or low oil pressure and what to do if light goes on), alternator indicator light (indicating whether alternator is charging). These areas are often misunderstood.

AFTER-SALES INSPECTION

In the interest of the purchaser and dealer, an After-Sale inspection should be carried out by the dealer after the first 100 hours of using a new JOHN DEERE tractor.

The purpose of this inspection is to make sure that the customer is receiving satisfactory performance from his tractor. At the same time, the inspection should reveal whether or not the tractor is being operated, lubricated and serviced properly.

NOTE: Should any malfunction occur during the inspection, then refer to Technical Manual "Engines" or "Operation and Tests".

Through this inspection, a needless volume of service work can be eliminated by preventing minor difficulties from developing into serious problems later on. It will also promote stronger dealer-customer relations and give the customer an opportunity to ask questions that may have arisen during the first few days of use. The dealer may also have the further opportunity of promoting the possible sale of other new equipment.

The following inspection program is recommended:

INSPEK-LB21010HE-010886

CHECKING FUEL LINES FOR LEAKS

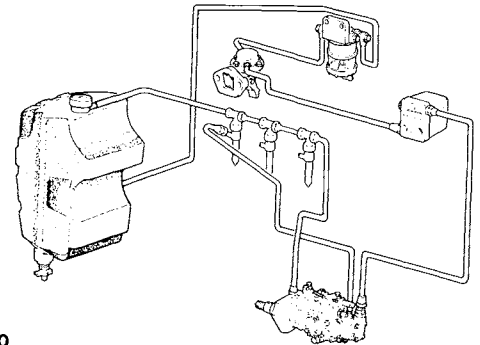

L116 280

L116280-LB41010AE-010687

EXAMINING ENGINE FOR LEAKS

INSPEK-LB21010EE-010886

CHANGING ENGINE OIL

Drain oil while engine is shut off, but still warm.

A—Drain plug

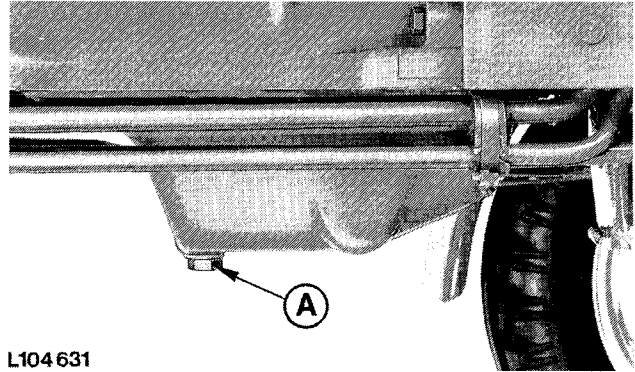

Fill with fresh oil of the correct viscosity (see Group 15).

Oil quantity with filter change:
6.0 liters (1.6 U.S. gal.)

B—Filler neck

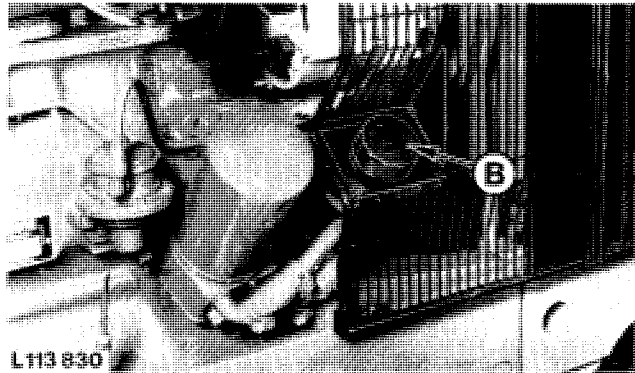

L104631,L113830-LB41010AE-010687

CHANGING ENGINE OIL FILTER

Unscrew oil filter (A) and clean filter mounting surface (B).

Apply a thin layer of oil to seal ring (C). Screw in new filter until seal ring just touches mounting surface, then turn an additional 1/2 to 3/4 turns. Do not over-tighten.

Start engine and check drain plug and filter seat for leaks.

Shut off engine and check oil level.

A—Oil filter
B—Filter mounting
surface
C—Seal ring

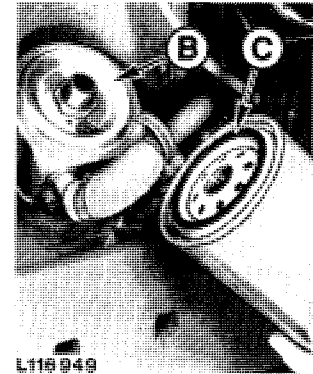
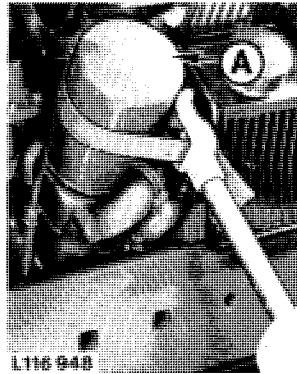

L116948,L116949-LB41010AE-010687

CHECKING VALVE CLEARANCE

Check valve clearance using a feeler gauge.

Valve clearance (with engine cold or warm):

- Intake valve: 0.35 mm (0.014 in.)
- Exhaust valve: 0.45 mm (0.018 in.)

If required, readjust valve clearance.

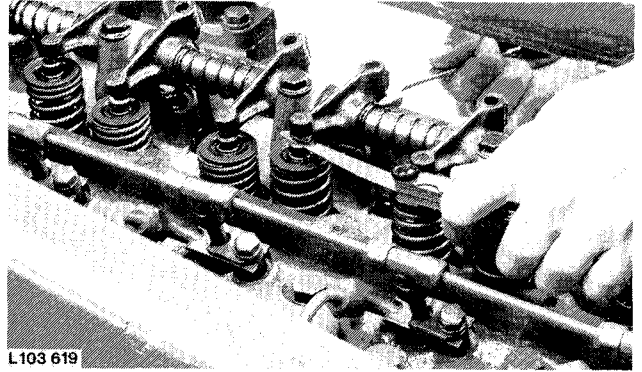

L103619-LB21010AE-010886

CHECKING COOLANT LEVEL

Up to Tractor Serial No. 621 999 L:

Coolant must reach up to marker plate in radiator.

If necessary, add coolant. See Group 15.

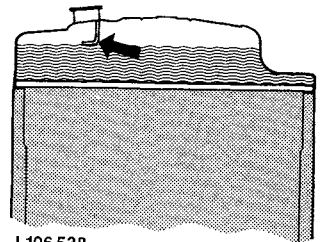
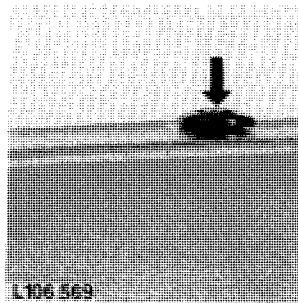

L106569,L106538-LB41010AE-010687

From Tractor Serial No. 622 000 L:

Level of coolant should not be below the mark "MIN".

If necessary, add coolant. See Group 15.

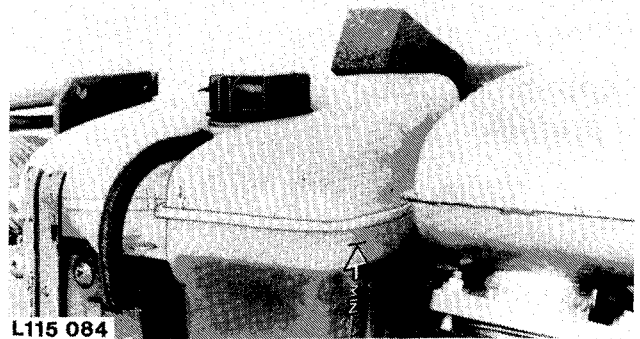

L115084-LB81010AE-010489

CHECKING ENGINE IDLE SPEEDS

Tractors with Synchronized Transmission

Warm up engine to operating temperature and check speeds.

- Slow idle speed: 750 to 850 rpm
- Fast idle speed : 2410 to 2510 rpm

See Section 30, Group 15, for adjustment.

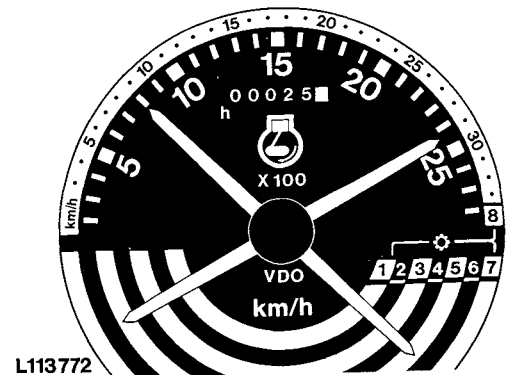

L113772-LB31010AE-010287

Tractors with Collar Shift Transmission

Warm up engine to operating temperature and check speeds.

Slow idle speed: 750 to 850 rpm

Fast idle speed: 2610 to 2660 rpm

See Section 30, Group 15, for adjustment.

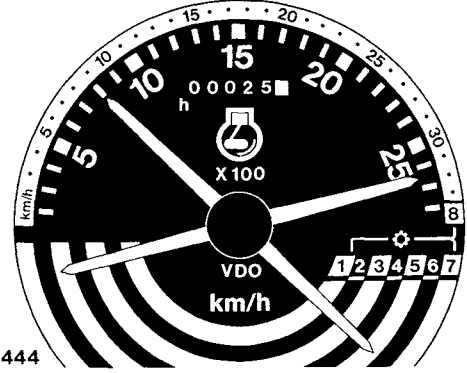

L113 444

L113444-LB31010AE-010287

CHECKING FUNCTION OF HAND THROTTLE LEVER

Check function of hand throttle lever.

See Section 30, Group 15, in the event of malfunctions.

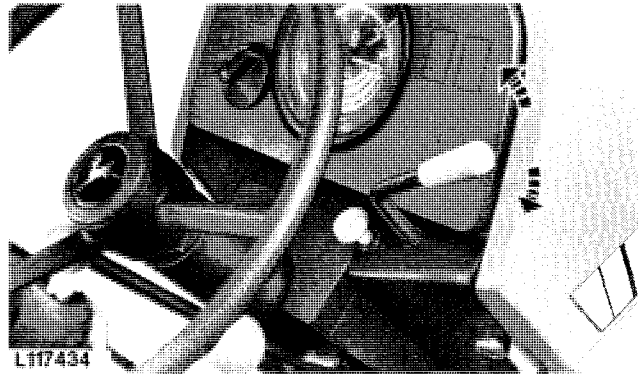

L117 434

L117434-LB81010AE-010787

CHECKING FUNCTION OF ENGINE SHUT-OFF CABLE

Run engine for 1 to 2 minutes at slow idle speed.

Completely pull out shut-off knob (A), making sure engine stops immediately. Switch off main switch (B).

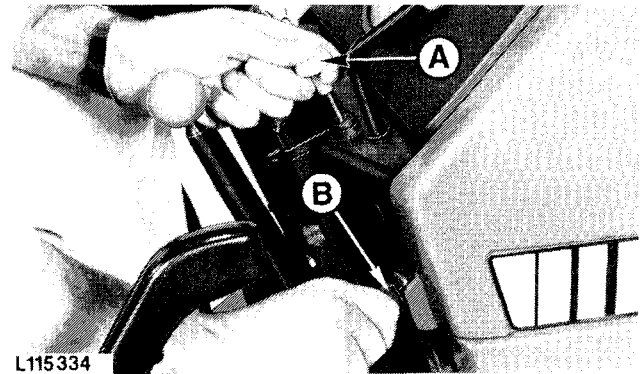

L115 334

L115334-LB81010AE-010787

CHECKING AIR CLEANER AND SAFETY ELEMENTS FOR CORRECT INSTALLATION

Make sure that dust unloading valve (C) (rubber cap) is installed on air cleaner.

- A-Air cleaner element
- B-Safety element
- C-Dust unloading valve

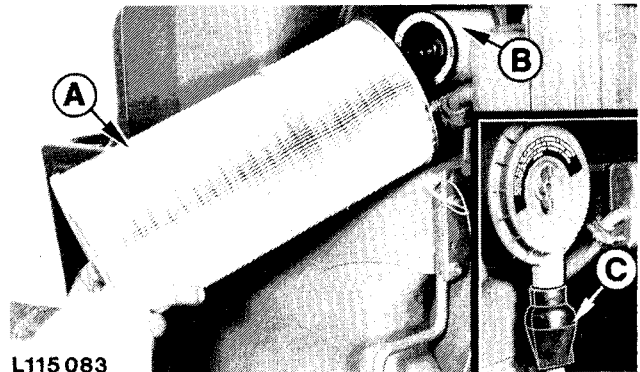

L115 083

L115083-LB41010AE-010687

CHECKING HOSE CLAMPS OF AIR INTAKE SYSTEM FOR TIGHTNESS

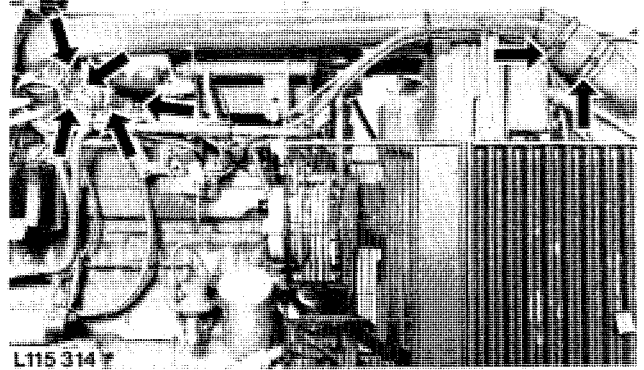

L115 314

L115314-LB71010AE-010487

CHECKING FAN BELT TENSION

Using belt tension gauge JDST-28 (C) check tension of fan belt.

Fan belt should have 19 mm (3/4 in.) flex with 90 N (20 lb) pull midway between crankshaft and alternator or water pump.

- A-Fan belt
- B-Attaching nut
- C-Belt tension gauge (JDST-28)

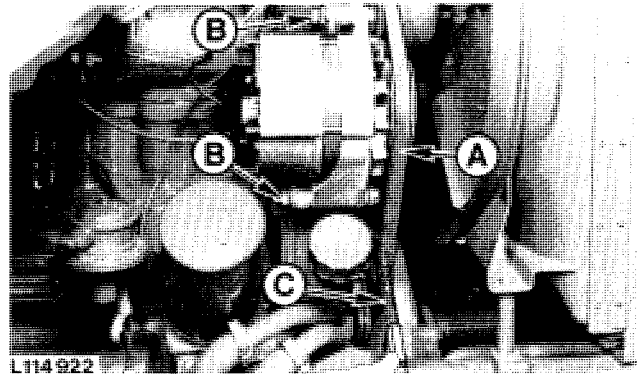

L114 922

L114922-LB21010AE-010886

CHECKING BATTERIES

Check battery terminals and battery cable ends and, if necessary, clean and coat them with petroleum jelly.

Check specific gravity of battery cells. At an electrolyte temperature of 20° C (68° F), a fully charged battery should have a specific gravity of 1.28 under normal and arctic conditions and 1.23 in tropical areas.

Check electrolyte level in each battery cell. Add distilled water if necessary to bring level above cell plates.

Charge batteries if they are not fully charged. Remove filler caps before charging the battery.

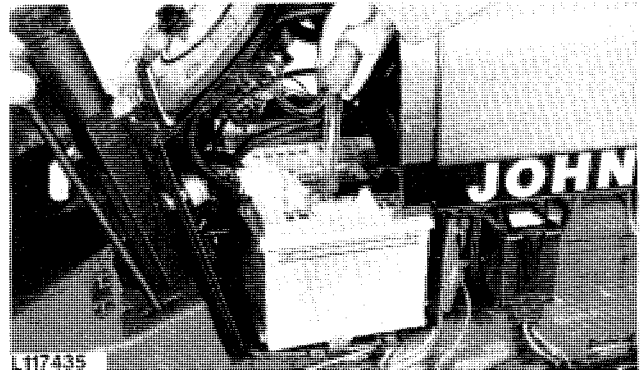

L117435

L117435-LB81010AE-010787

IMPORTANT NOTES

If the engine is to be run for a short time without battery (using a slave battery for starting), do not, under any circumstances, interrupt this circuit by switching off the main switch before stopping the engine by means of the fuel pump shut-off cable. An additional load (lights) must also be switched on. Do not run engine above 1000 rpm. Insulate battery end of disconnected starter cable properly to avoid damage to alternator and regulator.

Observe proper polarity when connecting batteries and chargers. Improperly connected batteries ("+" and "-") result in immediate destruction of rectifier diodes.

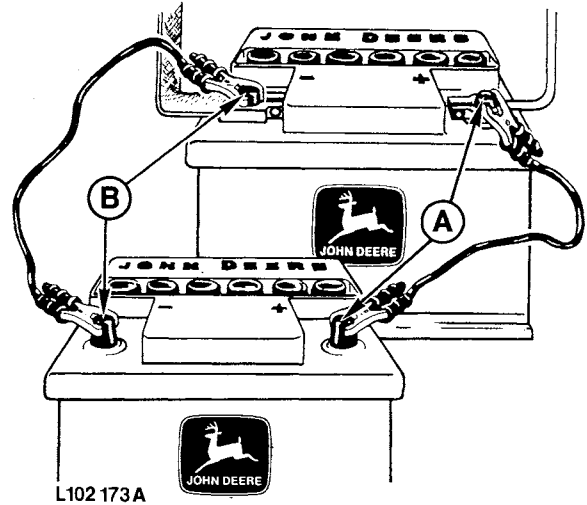

A-Positive terminals
B-Negative terminals

L102173A-LB81010AE-010787

CHECKING NEUTRAL START SYSTEM

Depress clutch pedal (A).
Move gear shift lever (B) to neutral position.
Move range shift lever (C) to any range position.
Pull out engine shut-off knob (D).
Turn main switch (E) to start position.
Starter should NOT crank.

A-Clutch pedal
B-Gear shift lever
C-Range shift lever
D-Engine shut-off knob
E-Main switch

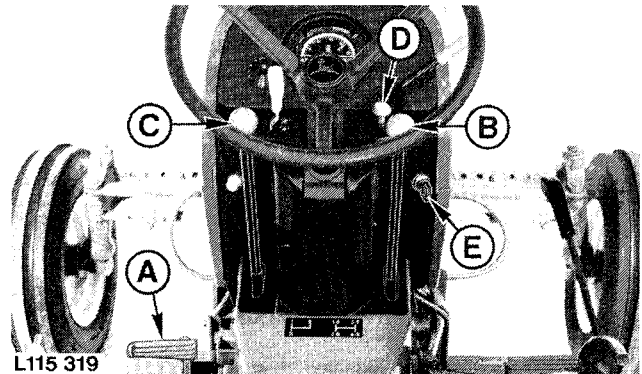

L115319-LB81010AE-010787

CHECKING LIGHTING SYSTEM

See Operator's Manual.

Check adjustment of headlights and adjust, when necessary.

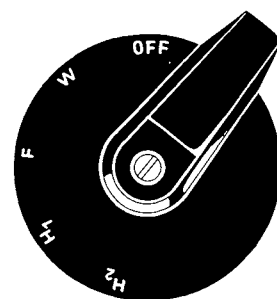

L 117 815

L117815-LB81010AE-010787

CHECKING INSTRUMENTS AND INDICATOR LIGHTS

See Operator's Manual.

INSPEK-LB21010FE-010886

CHECKING TORQUE OF ADJUSTABLE FRONT AXLE BOLTS (When Equipped)

Tighten axle bolts (A) to 400 Nm (300 ft-lb).

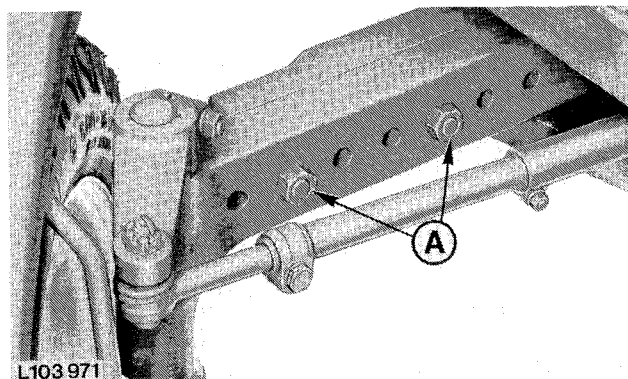

L103 971

L103971-LB41010AE-010687

CHECKING TIE ROD BOLTS (Tractors without Front Wheel Drive)

Tighten clamping screws (A) to 55 Nm (40 ft-lb) and clamping screw (B) to 90 Nm (65 ft-lb).

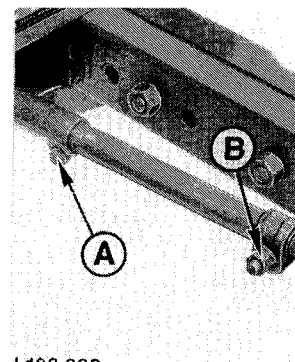

L103 992

L103992-LB41010AE-010389

CHECKING TIE ROD BOLTS (Tractors with Front Wheel Drive)

Tighten clamping screws (A) to 55 Nm (40 ft-lb) and clamping screw (B) to 90 Nm (65 ft-lb).

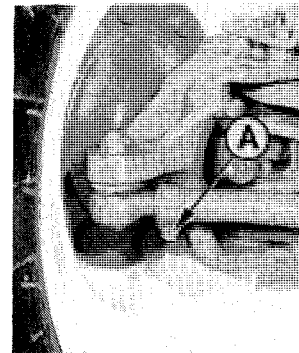

L104 609

L104609-LB41010AE-010389

CHECKING TRANSMISSION/HYDRAULIC SYSTEM OIL LEVEL

IMPORTANT: Check oil level when oil is cold.

Park tractor on level ground. Completely lower rock-shaft. Remove dipstick (A) and wipe clean. Reinsert dipstick, again remove and check oil level.

NOTE: If oil level is below top mark, top up with oil to bring level up to top mark on dipstick through filler neck (B).

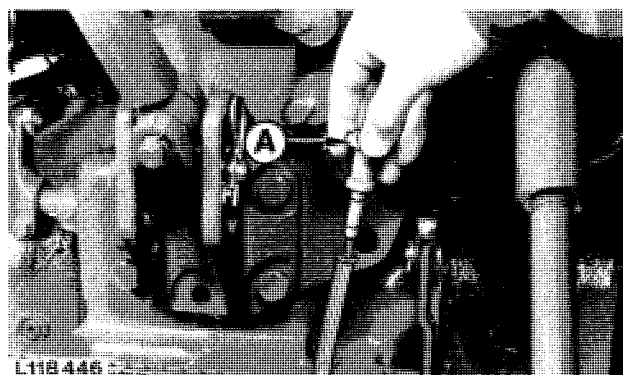

L118 446

IMPORTANT: After having topped up transmission with oil, wait for a period of five minutes before rechecking oil level with dipstick.

If necessary, add JOHN DEERE Hy-Gard transmission and hydraulic oil or equivalent (see Group 15) to bring oil level to top mark on dipstick.

NOTE: Types of oil not meeting our specifications will not give satisfactory service and may result in damage.

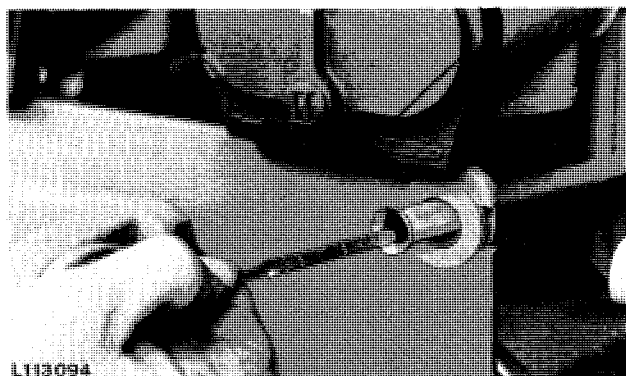

L113094

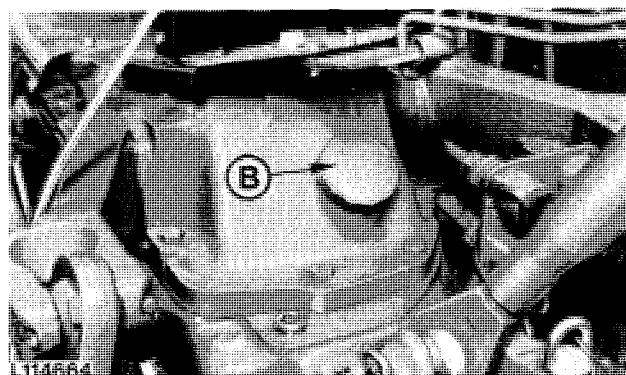

L114664

L118446.L113094.L114664-LB41010AE-010389

CHECKING CLUTCH PEDAL FREE TRAVEL

Tractors Without Reverser Transmission

Clutch pedal free travel (A) should be 25 mm (1 in.).

If necessary, adjust clutch pedal free travel by turning yoke (B).

IMPORTANT: Clutch pedal free travel should never be less than 13 mm (approx. 1/2 in.). Should clutch pedal free travel be less than specified minimum, do not operate tractor until travel has been adjusted to specifications.

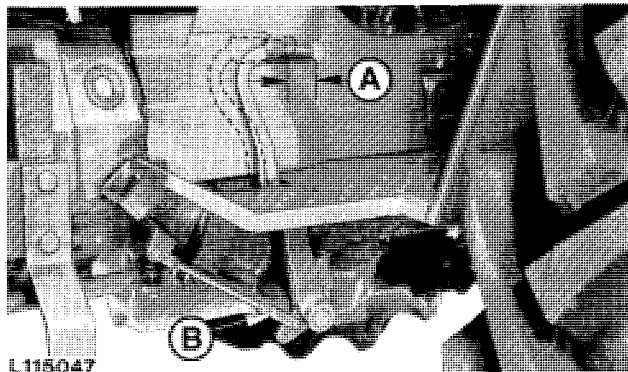

L115047-LB81010AE-010787

Tractors With Reverser Transmission

Push clutch pedal down until operating rod is positioned in rear of slot (A) in clutch shaft arm.

There should be 133 mm (5-1/4 in.) between engine mounting flange and rear of clutch pedal pad (B).

If necessary, adjust clutch pedal free travel by turning yoke (C).

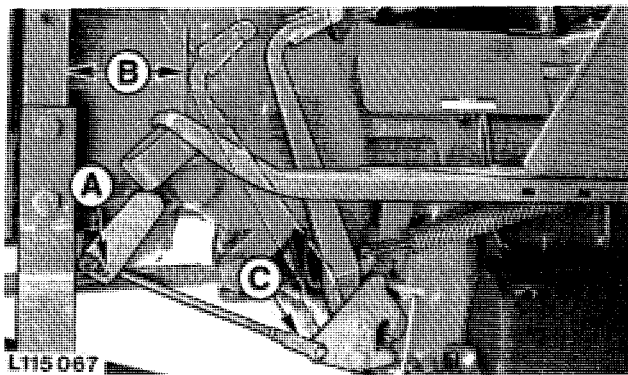

L115067-LB71010AE-010487

Pedal free travel (A) to shift reverser transmission should be 19 to 32 mm (3/4 to 1-1/4 in.).

If necessary, adjust pedal free travel by backing off screw (B) and turning adjusting screw (C).

A-Pedal free travel
B-Pedal shaft screw
C-Adjusting screw

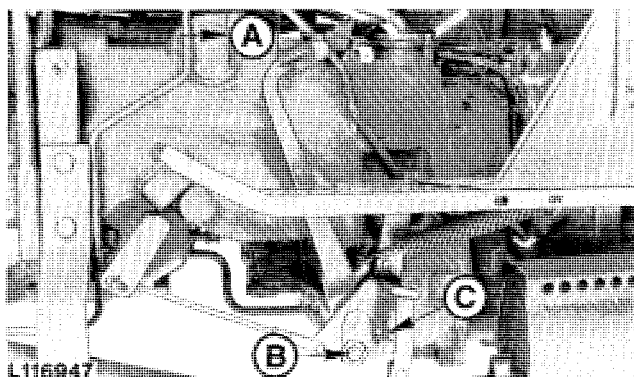

L116947-LB71010AE-010487

CHECKING TRANSMISSION

Drive tractor on trial run, shifting transmission through all gears. Remedy any defects.

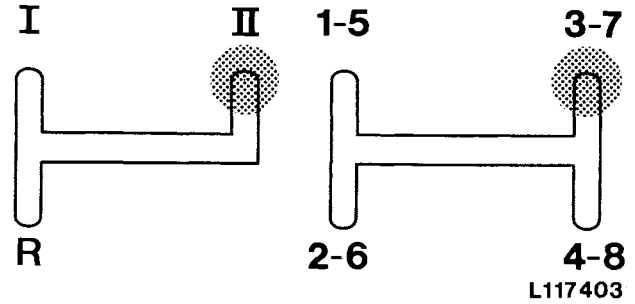

L117403-LB41010AE-010687

CHECKING DIFFERENTIAL LOCK

Drive tractor, checking functions of differential lock by operating hand lever (A) or pedal (B).

IMPORTANT: Never turn the tractor with differential lock engaged.

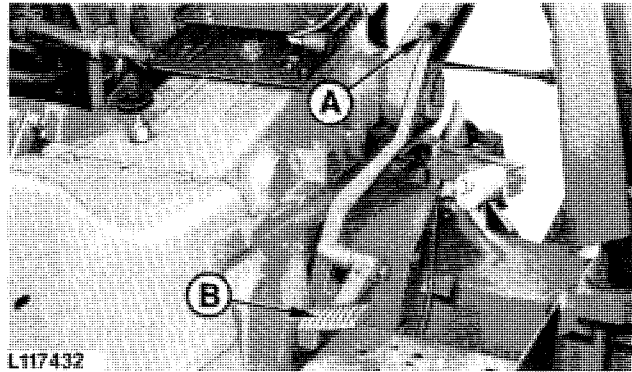

L117432-LB81010AE-010787

CHECKING REAR PTO

Run engine.

Up to Tractor Serial No. 618 706L: Raise shift lever and push forward.

From Tractor Serial No. 618 707L: Raise shift lever.

A-PTO disengaged
B-PTO engaged

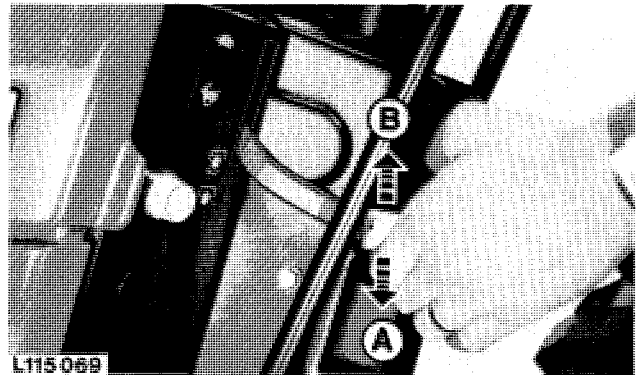

L115069-LB81010AE-010489

CHECKING CONTINUOUS-RUNNING PTO (Tractors With Collar Shift Transmission)

Fully depress clutch pedal (A) and engage PTO by means of lever (B).



CAUTION: Never engage PTO with tractor in motion.

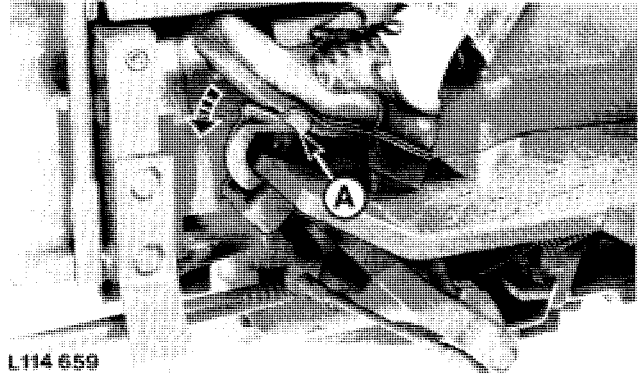

L114 659

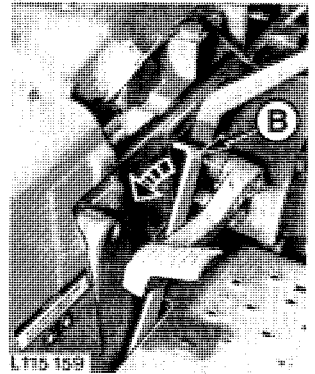

L115 159

L114659,L115159-LB31010AE-010287

CHECKING HI-LO SHIFT UNIT (When Equipped)

Drive tractor and operate Hi-Lo shift unit, i.e. move Hi-Lo shift unit lever to both reduced and normal speed positions several times, precisely observing Hi-Lo shift unit operation each time.

Simulate tractor working under load by applying brakes.

Low oil pressure will be indicated by disk pack slippage, causing the clutch pack to become noisy.

Mechanical failure in the Hi-Lo shift unit will also be indicated by unusual noise.

A-Reduced speed
B-Normal speed

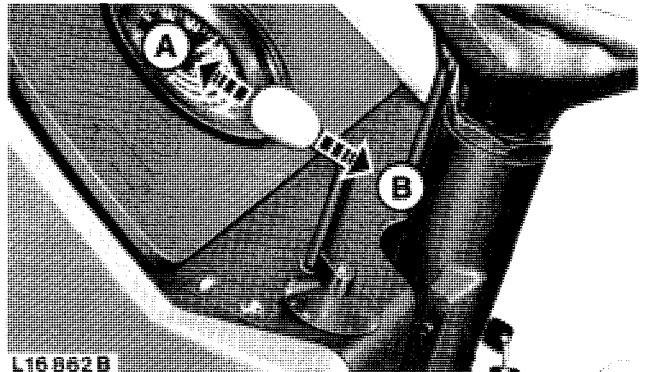

L16 862 B

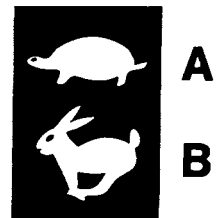

L12488 A

L16862B,L12488A-LB81010AE-010787

CHECKING CREEPER TRANSMISSION (When Equipped)

IMPORTANT: Engage creeper transmission only in I (Low) or reverse range and with clutch pedal depressed.

- A-Reduced speed
- B-Normal speed
- C-Control lever lock

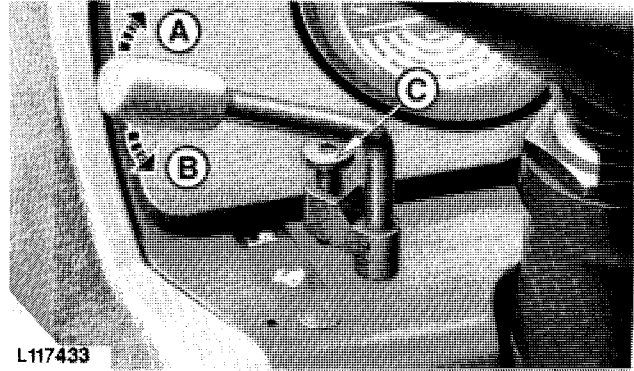

L117433



L 14797A

L117433,L14797A-LB81010AE-010787

CHECKING REVERSER TRANSMISSION (When Equipped)

NOTE: An interlock in transmission prevents selection of "Reverse" as long as transmission is in high range.

- A-Forward travel (lever toward front)
- B-Rearward travel (lever toward rear)



CAUTION: Reverse speeds are 16% higher than their respective forward speeds. Use extra care when travelling at higher speeds.

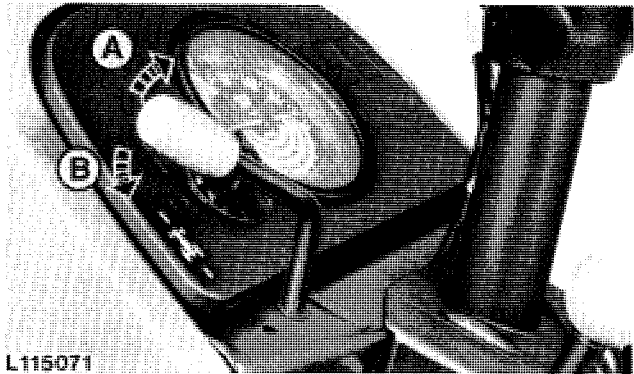

L115071



L 115072

L115071,L115072-LB71010AE-010487

CHANGING FRONT WHEEL DRIVE AXLE OIL (When Equipped)

NOTE: Only change oil directly after having operated tractor for some time.

Fill with an EP transmission oil as specified in Group 15 of this section.

Front Axle Housing

Capacity:

- 2155 4.6 liters (1.2 U.S. gal.)
- 2355 N 3.5 liters (0.92 U.S. gal.)

Wheel Hub Housing

After draining oil, turn wheel until oil level mark is horizontal.

Capacity: 0.5 liters (0.13 U.S. gal.)

- A-Drain plug
- B-Level plug
- C-Drain and level plug

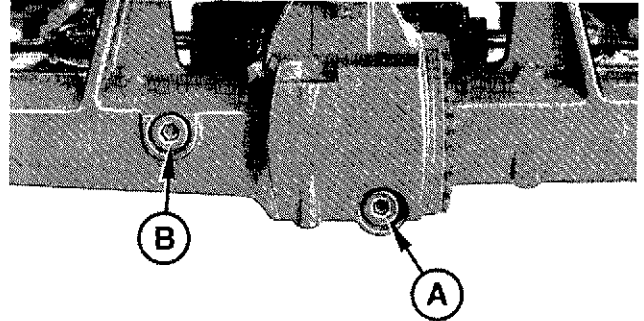

L100061A

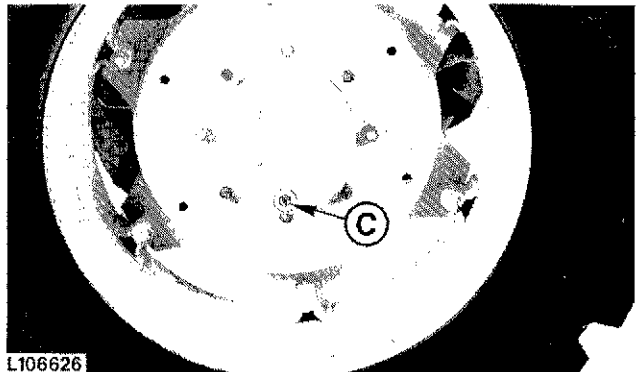

L106626

L100061A, L106626-LB81010AE-01C787

CHECKING FUNCTION OF FRONT WHEEL DRIVE (When Equipped)

Drive tractor, engaging and disengaging front wheel drive by operating tumbler switch.

- A-Front wheel drive engaged
- B-Front wheel drive disengaged
- C-Control light glows when front wheel drive is engaged

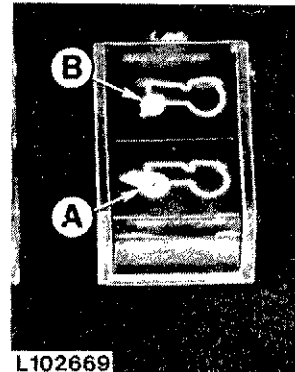

L102669

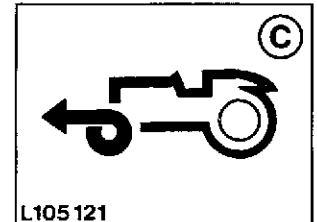

L105121

L102669, L105121-LB21010AE-010886

CHECKING FUNCTION OF FOOT BRAKES

Load each brake pedal with 270 N (60 lb) for one minute. Loaded pedal should drop approx. 25 mm (1 in.) only during this time.

NOTE: Do not check both brake pedals simultaneously, but each pedal individually.

- A-Pedal coupler

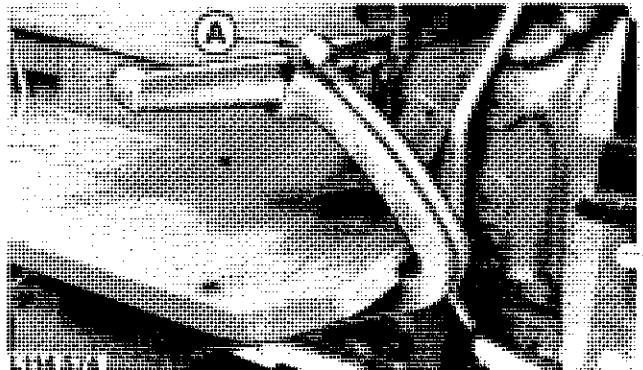

L114574

L114574-LB41010AE-01C687



Suggest:

If the above button click is invalid.

Please download this document

first, and then click the above link

to download the complete manual.

Thank you so much for reading

CHECKING HANDBRAKE ADJUSTMENT

Tighten brake band support screw on underside of transmission case hand-tight, then back off half-a-turn and lock in position by means of hex. nut.

NOTE: The brake band support screw is backed off two turns at the factory. After approximately 100 hours of operation, tighten support screw hand-tight and back off half-a-turn.

Pull handbrake lever to third or fourth notch with a force of 110 N (25 lb).

When necessary, adjust handbrake (see Section 60, Group 15).

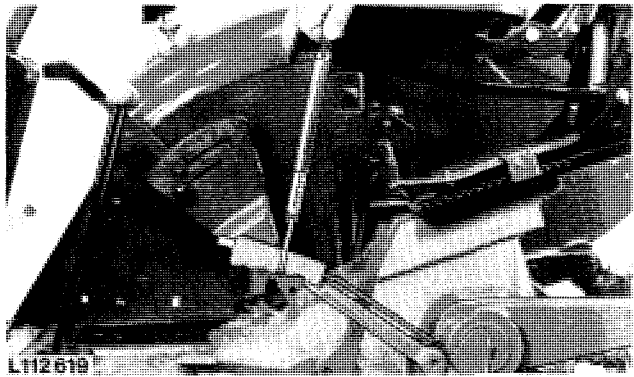
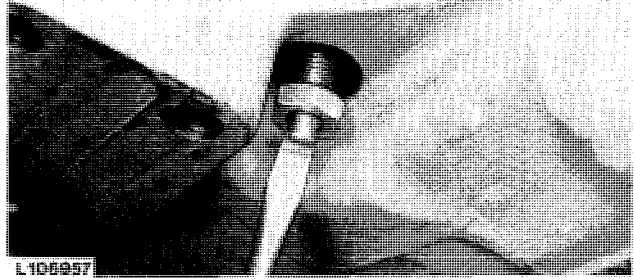

L106957, L112619-LB81010AE-010489

CHECKING ROCKSHAFT FUNCTIONS

See Operator's Manual.

- A—Raise implement
- B—Lower implement

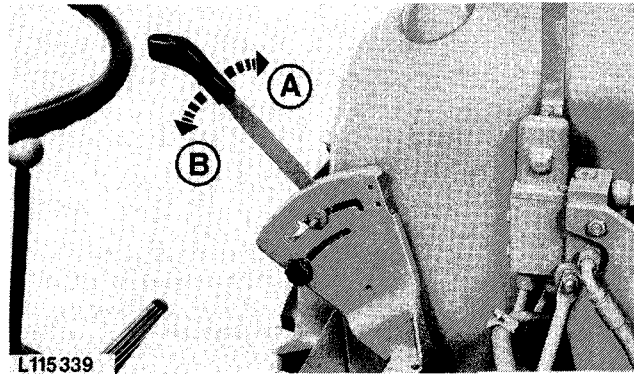

L115339-LB81010AE-000787

<https://www.ebooklibonline.com>

Hello dear friend!

Thank you very much for reading.

Enter the link into your browser.

The full manual is available for immediate download.

<https://www.ebooklibonline.com>