

# John Deere 2000 Series Crawler Tractors



## SERVICE MANUAL John Deere 2000 Series Crawler Tractors

SM2037 (01MAY87) English

**SM2037 (01MAY87)**

LITHO IN U.S.A.  
ENGLISH

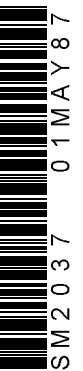

**JOHN DEERE****2000** SERIES**CRAWLER TRACTORS****CONTENTS**

	<i>Section</i>
Description and Specifications .....	10
Tractor Separation .....	20
Periodic Lubrication .....	30
Engine Tune-Up and Tractor Adjustment .....	40
Engine (Basic)—Gasoline .....	50
Engine (Basic)—Diesel .....	51
Engine Lubrication System .....	60
Governor and Linkage .....	70
Cooling System .....	80
Gasoline Fuel System .....	90
Diesel Fuel System .....	91
Electrical System .....	100
Engine Clutch (Constant Mesh Transmission) .....	110
Clutch Disconnect and Clutch Pedal (H-L-R Transmission) .....	111
Transmission and Ring Gear (Constant Mesh) .....	120
Transmission and Ring Gear (H-L-R) .....	130
Power Take-off, Auxiliary Pump Drive, and Winch Drive .....	140
Series 20 Winch .....	145
Final Drives, Steering Clutch and Brakes .....	150
Hydraulic System .....	160
3-Point Hitch and Drawbar .....	170
Track System .....	180
Trouble Shooting .....	190

Copyright ©1987  
**DEERE & COMPANY**  
 Moline, Illinois  
 All rights reserved  
 Previous Editions  
 Copyright ©1965 Deere & Company  
 Copyright ©1964 Deere & Company  
 Copyright ©1962 Deere & Company

## Section 10

# DESCRIPTION AND SPECIFICATIONS

### Group 5

## DESCRIPTION

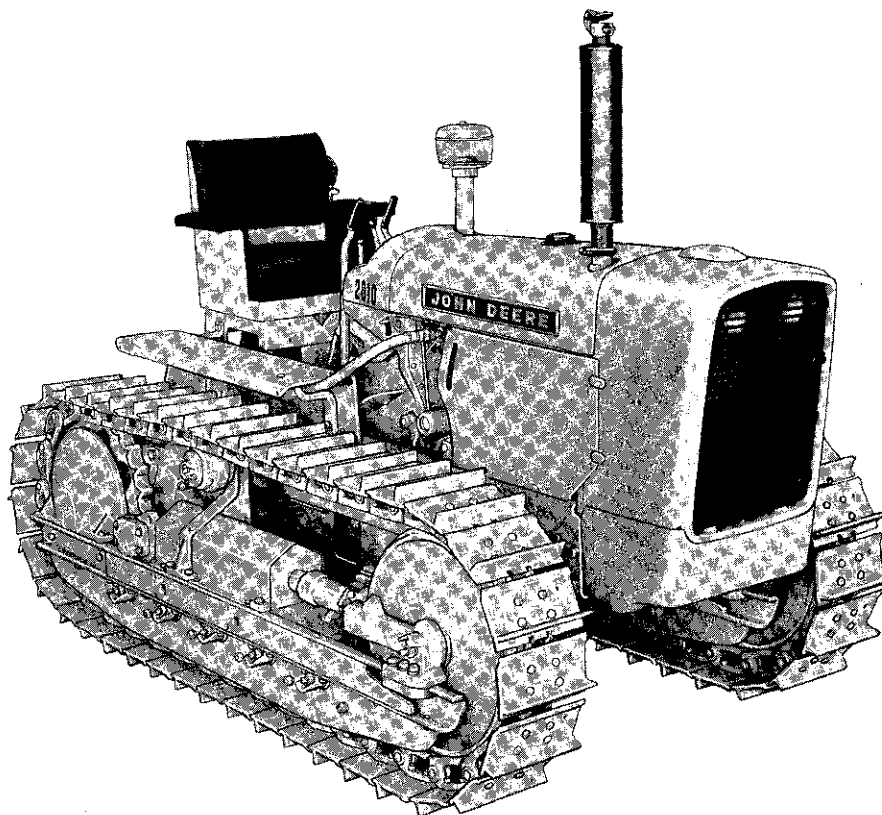

Fig. 10-5-1—Right-Hand View of 2010 Crawler Tractor

The John Deere 2010 Series Crawler Tractor (Fig. 10-5-1) is rugged and strong to meet the needs of industrial users. Its track-laying tread makes this tractor especially useful whenever good flotation and additional traction or extra stability are desirable. Because of the wide variety of equipment available for use with this tractor, the 2010 Crawler plays an important role in the construction and logging industries.

### FEATURES

#### GASOLINE ENGINE

The 2010 Series Gasoline Crawler has a vertical, 4-cylinder, valve-in-head, four stroke

cycle, internal combustion engine. A bore of 3-5/8 inches and a stroke of 3-1/2 inches gives a piston displacement of approximately 145 cubic inches. The compression ratio is 7.9 to 1. Pistons with 9.0 to 1 compression ratio are available for high altitude operation.

Engine speeds are controlled by a flyweight-type governor, gear-driven from the camshaft gear.

The tractor is equipped with a 16 U.S. gallon fuel tank and a conventional, updraft-type carburetor.

Gasoline models have a battery-distributor-type ignition system with automatic spark advance. A 12-volt battery, generator, and starter are standard equipment.

**<https://www.ebooklibonline.com>**

Hello dear friend!

Thank you very much for reading.

Enter the link into your browser.

The full manual is available for immediate download.

**<https://www.ebooklibonline.com>**

**DIESEL ENGINE**

The 2010 Series Diesel Crawler has a vertical, 4-cylinder, valve-in-head, fuel injection, four-stroke cycle, internal combustion engine. A bore of 3-7/8 inches and a stroke of 3-1/2 inches gives a piston displacement of approximately 165 cubic inches. The compression ratio of the diesel engine is 19 to 1. Engine speeds and injection timing are controlled by the fuel injection pump.

The 2010 Series diesel engine uses a distributor-type fuel injection pump. The fuel system consists of a 16-gallon fuel tank, two fuel filters, fuel strainer, turbulence chambers, fuel injection pump and nozzles.

The fuel injection pump is an opposed plunger, inlet metering, distributor-type. Injection nozzles are of the outward opening pintle type and are located in turbulence chambers mounted at the top of each cylinder.

The diesel engines are equipped with electrical pre-heating devices called "glow plugs" which are located above the fuel injectors on the turbulence chambers. The engines may also be equipped with a solid fuel primer located on the air intake manifold. Both devices are used for cold weather starting only. For information regarding engine starting, refer to the tractor's operator's manual.

A 12-volt battery actuates the diesel starting system.

**DIESEL AND GASOLINE ENGINES**

Crankshaft rotation is clockwise when viewed from the front.

A wet-type "sleeve and deck" assembly is used. This feature allows worn cylinder walls to be renewed without replacing or reboring the cylinder block.

The engines have replaceable precision-type main and connecting rod bearing inserts. All bearings and other parts of the engine are lubricated by a force-feed and splash-type system with a bypass-type oil filter. The system includes a positive displacement gear-driven oil pump. The pump is located underneath the fuel injection pump on diesel models and underneath the dis-

tributor on gasoline models. The pump extends into the bottom of the crankcase. Oil is fed under 35 to 50 pounds pressure to the lubricating parts of the engine.

The engines are liquid cooled with a pressure type system; the coolant flows through passages around the cylinders in the block, and around valves in the cylinder head and through the radiator by a centrifugal water pump located on the cylinder block, and operated by the fan belt. A thermostat and fixed bypass insure a quick and thorough engine warm-up.

**LIGHTING SYSTEM**

All lighting equipment is optional and includes grille-mounted headlights, a dash light, a combination white and red rear warning light, and auxiliary plug-in light socket.

**TRANSMISSION (CONSTANT MESH)**

The constant mesh transmission consists basically of the shafts which carry the necessary gears, pinions, collar gears, and shifters to provide eight forward speeds and four reverse speeds. It is a selective sliding-collar type and is clutched and shifted manually.

**TRANSMISSION (H-L-R)**

The H-L-R transmission is basically a standard collar shift transmission plus an automatic reverser and underdrive unit. The gears in the speed change box are shifted manually, while the gears in the range change box are shifted hydraulically by means of hydraulic clutches. The operator can use the reverser lever to select a high, low, or reverse range for any shift station. This gives a choice of eight forward gears and four reverse gears.

**ENGINE CLUTCH**

The engine clutch used on the constant mesh and H-L-R transmissions is a single, dry disk type with friction facings riveted to either side of the driven disk. When in the engaged position, these facings contact the rear surface of the engine flywheel and the pressure plate.

On the constant mesh transmission the clutch assembly is controlled by a pedal and is used for transmission shifting.

On the H-L-R transmission the clutch assembly is controlled by a disconnect lever and is used only for cold weather starting.

In both cases movement is transmitted through the linkage assembly and throw-out bearing to the pressure plate.

#### POWER TAKE-OFF

The power take-off is an engine-driven type and is completely independent of tractor ground travel. It fully meets all ASAE-SAE standards.

#### BRAKES

The two brakes are of the contracting band type, and are operated by a pedal located on the right-hand side of the tractor. A brake lock, located above the brake pedal, holds the brakes in the applied position when the tractor is parked.

#### STEERING MECHANISM

The 2010 Crawler Tractor is steered by two combination clutch and brake mechanisms located in the steering clutch housings. Pulling back on a steering lever separates the drive facings and driven plates of the dry-type multiple disk clutch on that side, interrupting flow of power to that track sprocket. Any further rearward movement of the steering lever contracts a brake band around the drum on the clutch driven assembly, retarding or stopping motion of the sprocket and track.

The brake bands can also be operated by the pedal located on the right-hand side of the tractor. Depressing the pedal applies both brakes; it does not disengage the steering clutches.

#### 3-POINT HITCH

The 2010 Crawler Tractor may be equipped with a 3-point hitch to which a wide variety of equipment can be attached. The hitch is actuated through the rockshaft by one or two remote hydraulic cylinders.

The hitch is designed for use with equipment having a category 2 hitch.

#### TRACKS

The tracks are made of extremely tough steel. Replaceable, four-bolt track shoes are bolted to hardened links which are joined together by replaceable pressed-in pins and bushings. Track shoes are available in 10-, 12-, and 14-inch widths.

#### TRACK CARRIER ASSEMBLIES

Tracks are held in position by heavy steel carrier assemblies.

Track tread width is fixed at 48 inches.

Tracks are aligned and adjusted for tension by shifting the idler wheels forward or backward as required. A hydraulic track tension adjuster is available as optional equipment.

#### SERIES 20 WINCH

The Series 20 Winch is a gear-driven, hydraulically controlled mechanism that mounts by means of adapters to the left and right steering clutch housings and is coupled to, and driven by, the powershaft clutch drive shaft.

## Group 10 SPECIFICATIONS

### PERFORMANCE

	<u>Diesel</u>	<u>Gasoline</u>
Nebraska Test No. . . . .	830	829
Max. drawbar pull (lbs) . .	10,283	10,093
(gasoline tractor weighing 9550 lbs. and diesel tractor weighing 9645 lbs.)		
Max. PTO horsepower . . .	47.72	47.45
Max. drawbar horsepower	39.35	39.18

### ENGINE

Flywheel horsepower (SAE corrected) . . . . .	52.0	52.0
Torque (ft.-lbs.) Max. (SAE corrected) (1500 rpm) . .	124.5	119.0
Torque (ft.-lbs.) (SAE corrected) (2500 rpm) . . . . .	109.3	109.3
Number of cylinders . . . .	4	4
Bore and stroke (inches) . .	3-7/8 x 3-1/2	3-5/8 x 3-1/2
Displacement in cubic inches . . . . .	165	145
N.A.C.C. or A.M.A. horsepower rating for tax purposes . . . . .	24.03	21.03
Intake valve clearance (cold) (in.) . . . . .	0.012	0.012
Exhaust valve clearance (cold) (in.) . . . . .	0.018	0.018
Compression ratio . . . . .	19 to 1	7.9 to 1*
Slow-idle (rpm) . . . . .	800	600
Fast-idle (rpm) . . . . .	2650	2700
Working speed range (rpm) . . . . .	1500-2500	1500-2500

Engine clutch: 1. Constant Mesh: 11-inch spring-loaded, dry disk, foot operated.

2. H-L-R: 10-inch, spring-loaded, dry disk, hand lever operated (for cold weather starting only).

### TRANSMISSION

Constant Mesh: High range, low range, and reverse grouped to shift mechanically in series with 4-speed gear ratios to give eight forward speed and 4 reverse speeds. Helical gears.

H-L-R: High, low, and reverse grouped to shift (under full load with a hydraulic assist) in series with 4 speed gear ratios to give 8 forward speeds and 4 reverse speeds. Wet clutches.

\*9.0 to 1 for high altitude engines.

### TRAVEL SPEEDS, MPH (NO SLIP)

Gear	H-L-R Transmission		Constant Mesh Transmission	
	RPM		RPM	
	1500	2500	1500	2500
1st	.8	1.3	.9	1.5
2nd	1.1	1.8	1.1	1.8
3rd	1.2	2.0	1.4	2.3
4th	1.7	2.8	1.7	2.8
5th	1.8	3.0	2.1	3.5
6th	2.6	4.3	2.6	4.3
7th	2.8	4.7	3.3	5.5
8th	4.0	6.7	4.0	6.7
Rev. 1	1.0	1.7	1.0	1.7
Rev. 2	1.7	2.7	1.6	2.7
Rev. 3	2.5	4.1	2.5	4.1
Rev. 4	3.8	6.4	3.8	6.4

### CAPACITIES (U.S. Standard Measures)

Fuel tank . . . . .	16 U.S. gal.
Cooling system . . . . .	3 U.S. gal.
Air cleaner cup . . . . .	To mark
Engine crankcase (including filter) . . . . .	6 U.S. qts.

### Transmission Case:

H-L-R . . . . .	27 qts.
Constant Mesh ( -34742) . . . . .	27 qts.
Constant Mesh (34743-Up) . . . . .	32 qts.
Final drive case (each) . . . . .	1/2 gal.

### DIMENSIONS

Height to top of hood . . . . .	54-1/16 inches
Over-all height . . . . .	72-7/8 inches
Over-all width, min. . . . .	61-1/4 inches
Over-all length	
with drawbar . . . . .	120-7/16 inches
without drawbar . . . . .	112-7/16 inches

### Clearance

with drawbar . . . . .	11-1/4 inches
without drawbar . . . . .	11-11/16 inches
Shipping weight (approx.) . . . .	8500 Diesel 8400 Gasoline

## TRACK EQUIPMENT

Track frame . . . . .	5 roller
Track shoes (types and sizes):	
Open center full grouser (12- or 14- inch)	
All-purpose semi-grouser (12- inch)	
Steel grouser (10-, 12-, or 14- inch)	
Snow shoes (12- or 14-inch)	
Rubber (10-inch)	
Offset open center grouser (14- inch)	
Track tread (center to center) . . . .	48 inches
Number of track shoes (each side) .	39
Total ground contact area (sq. inch):	
10-inch shoes . . . . .	1445
12-inch shoes . . . . .	1734
14-inch shoes . . . . .	2023
Ground pressure (lbs. per sq. inch)	
with 14-inch shoes . . . . .	4.1
Length of track on ground (ins.) . . .	72-1/4

## STEERING

Clutches . . . . .	multiple disk
Brakes . . . . .	contracting band
Number of friction sur- faces (each clutch) . . . .	16
Turning clearance circle .	190 in.

## FINAL DRIVE

Induction hardened spur-gear type.	
Gears mounted on anti-friction type bearings	
Gear reduction ratio in first gear (engine to axle) (H-L-R) . . . . .	144 to 1
Gear reduction ratio in first gear (engine to axle) (Constant Mesh) . .	124.4 to 1

Gear reduction ratio in eighth gear (engine to axle) (H-L-R and Con- stant Mesh) . . . . .	27.2 to 1
--	-----------

## IGNITION SYSTEM (Gasoline)

Type . . . . .	Battery - distributor
Distributor point gap . . . . .	0.022-inch
Spark plugs	
Size . . . . .	14 mm
Gap . . . . .	0.025-inch

## ELECTRICAL SYSTEM

Battery (dry) voltage (nominal) . . . .	12 volts
Battery specific gravity	
full charge . . . . .	1.250 (plus or minus .010)
Battery terminal grounded . . . . .	positive
Generator regulation . . . . .	Voltage regulator
Fuse (electrical outlet socket) . . .	SFE 20
Fuse (front lights) . . . . .	AGC 7-1/2

## SERIES 20 WINCH

Drum speed (at 2200 rpm engine speed) . . . . .	58-1/2 rpm
Drum diameter . . . . .	6 inches
Drum capacities:*	
(with 1/2-inch cable) . . . . .	195 feet
(with 5/8-inch cable) . . . . .	125 feet
(with 3/4-inch cable) . . . . .	100 feet
Cable speeds (at 2200 rpm engine speed):	
(with bare drum) . . . . .	100 fpm
(with full drum) . . . . .	159 fpm
Cable pulls (at 2200 rpm engine speed):	
(with bare drum) . . . . .	13,900 lbs.
(with full drum) . . . . .	8,700 lbs.

*\*Calculated capacities—allowance must be made for looseness or uneven spooling.*

*(Specifications and design subject to change without notice)*

## Section 20

# TRACTOR SEPARATION

### Group 5

## SEPARATING FRONT END SUPPORT FROM ENGINE

Remove fuel tank cap and vertical muffler.

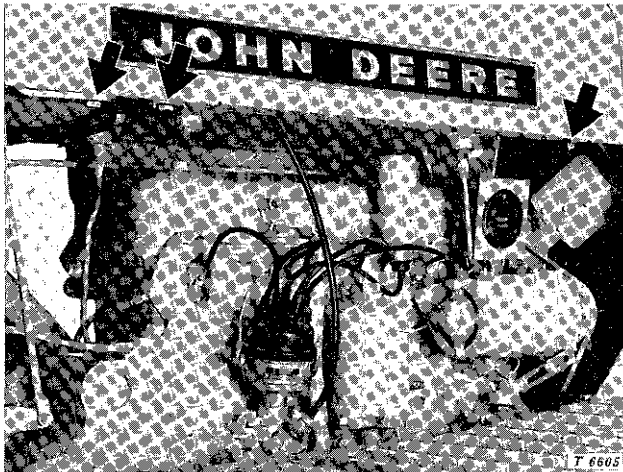

Fig. 20-5-1—Hood Attaching Points

On each side of hood, remove cap screws at rear (Fig. 20-5-1). Loosen hex. nuts on eyebolts attaching hood to grille housing. Lift off hood.

Remove grille screen and attach hoist to grille housing.

Disconnect leads from front headlights.

Remove the cap screws attaching grille to front end support.

With the aid of chain hoist remove grille housing.

Refer to illustrations and remove or disconnect the following parts.

1. Drain radiator and disconnect water inlet and outlet hoses. Remove oil cooler lines.

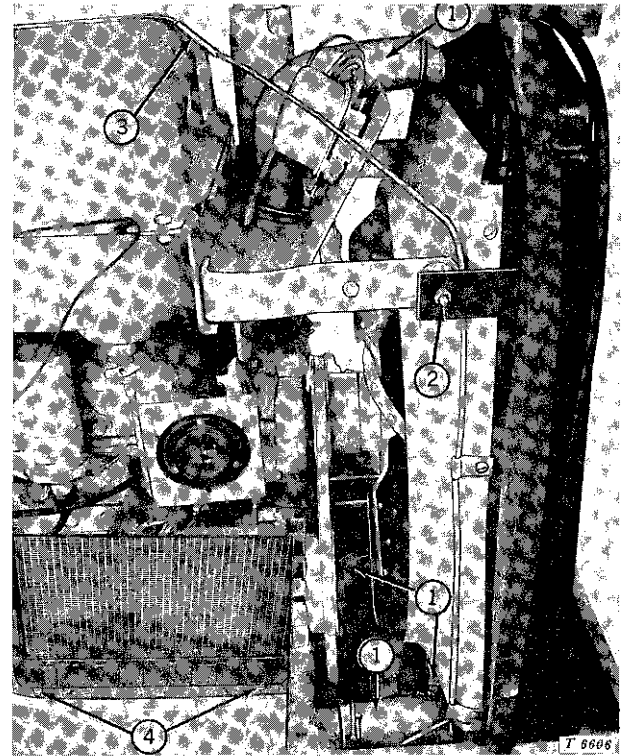

Fig. 20-5-2—Disconnecting Radiator

*NOTE: To prevent excessive loss of oil, keep transmission oil cooler lines propped up.*

2. Remove lock nuts which secure radiator braces to radiator.

3. Disconnect fuel vent line.

4. Remove stop nuts which secure the radiator to the front end supports. Lift radiator from tractor. Remove lower baffle.

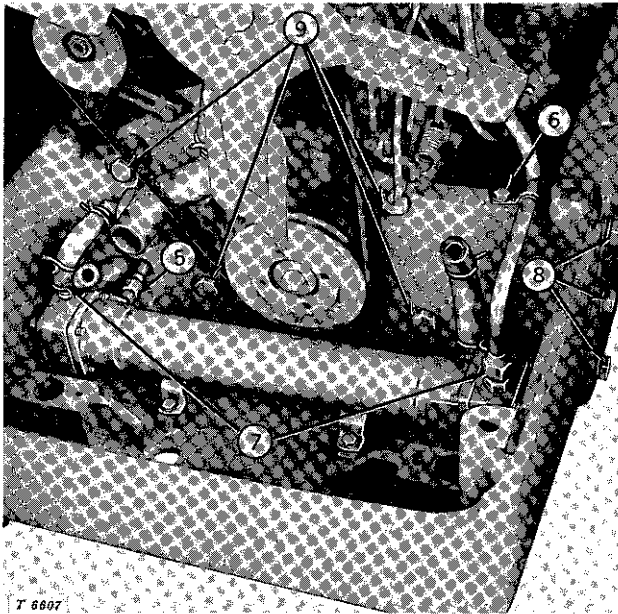

Tractors ( -45155) (H-L-R Unit Shown)

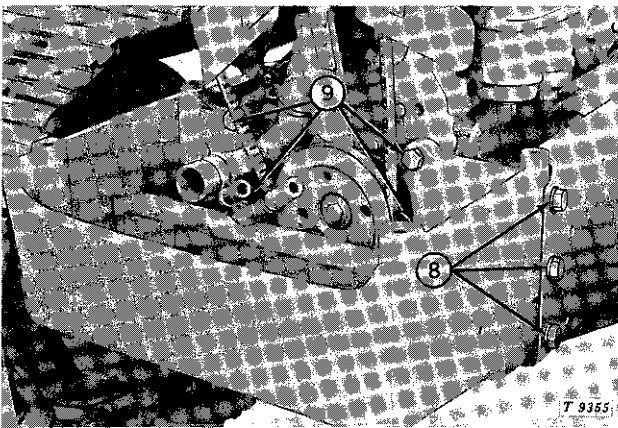

All Tractors (45156-Up)

Fig. 20-5-3—Removing Front End Support

5. On tractors ( -45155) equipped with H-L-R transmissions, disconnect oil cooler from hydraulic line.

6. On tractors ( -45155) equipped with H-L-R transmissions, remove clamp from water line.

7. On tractors ( -45155) equipped with H-L-R transmissions, disconnect water lines from cooler.

8. Remove the six cap screws attaching the front end support to the side frames. Remove five cap screws attaching front end support to bottom plate.

9. Remove the four cap screws attaching the front end support to the engine block and pull front end support free of engine.

### ASSEMBLY

Position the front end support in line with the mounting points of the engine and install the four attaching cap screws. Tighten cap screws to 170 foot-pounds.

Line up side frame with front end support and install cap screws with lock washers. Torque cap screws to 150 foot-pounds.

Secure bottom plate to front end support with cap screws and lock washers.

On tractors ( -45155) equipped with H-L-R transmissions, connect oil cooler lines and clamp the water line to the front end support.

Install radiator baffle.

Install radiator and secure with stop nuts.

Connect the radiator inlet and outlet hoses and the oil cooler lines to the radiator.

Connect fuel tank vent line.

Secure the radiator braces to the radiator.

Install grille housing on front end support with all baffling in place. Secure to front end support. Torque the rear screws to 85 foot-pounds. Torque the front screws to 170 foot-pounds.

Connect light leads.

Install grille screen in grille housing.

Secure hood and muffler. Install fuel tank cap.

Fill cooling system with clean soft water or antifreeze solution as required. Install radiator cap.

## Group 10

# SEPARATING ENGINE FROM CLUTCH HOUSING

Remove hood, grille housing, radiator and front end support (Group 5).

Disconnect battery ground strap.

Remove front bottom plate from tractor.

Disconnect oil cooler lines from rear of block connector on right side of engine. Remove front lines and block connector from tractor. Loosen connections on rear lines.

Refer to illustrations and remove or disconnect the following parts.

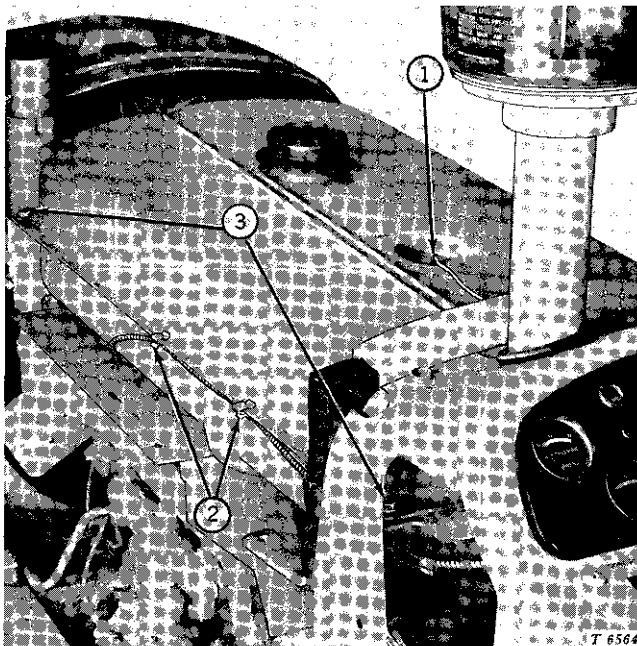

Fig. 20-10-1—Fuel Tank Attaching Points (Gasoline Illustrated)

1. Disconnect fuel gauge wire at fuel gauge sender.

Close fuel shut-offs and disconnect fuel tank outlet lines and fuel return line on diesel tractors. Close fuel shut-offs and disconnect fuel lines on gasoline tractors.

2. Remove clips attaching water temperature sending unit to fuel tank.

3. Remove the cowl cover. Remove the four cap screws attaching fuel tank to the front and rear fuel tank support brackets and remove tank.

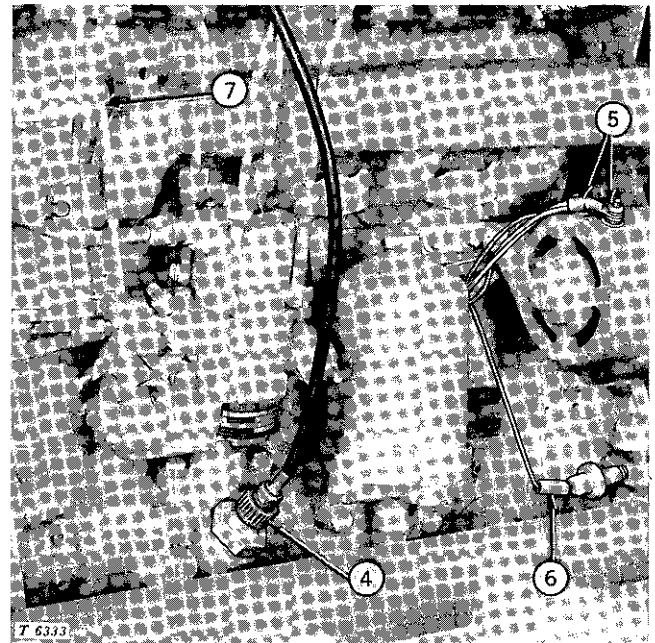

Fig. 20-10-2—Disconnecting Wiring and Linkage (Right Side of Diesel Engine)

4. Disconnect tachometer cable at coupling.

5. Disconnect wiring harness at generator.

6. Disconnect wiring harness at ignition coil (gasoline tractors) and at oil pressure sending unit.

7. Disconnect speed control rod from injection pump (diesel tractor) or bellcrank (gasoline tractor).

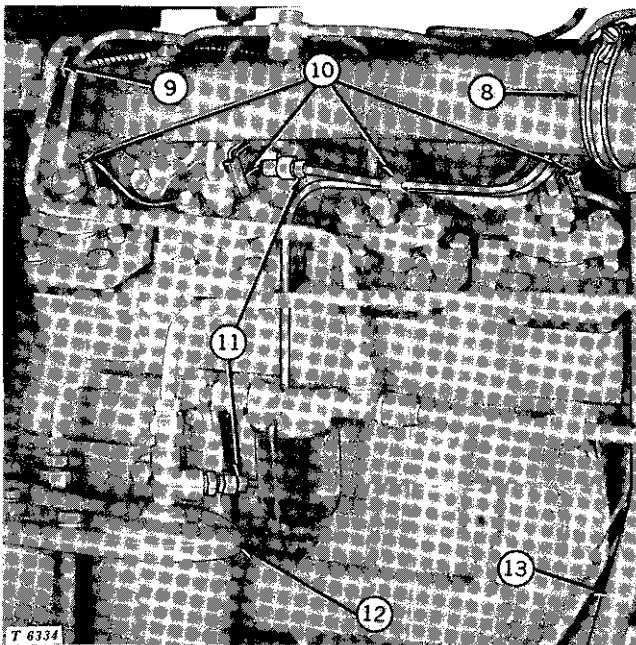

Fig. 20-10-3—Disconnecting Wiring and Linkage  
(Left Side of Diesel Engine)

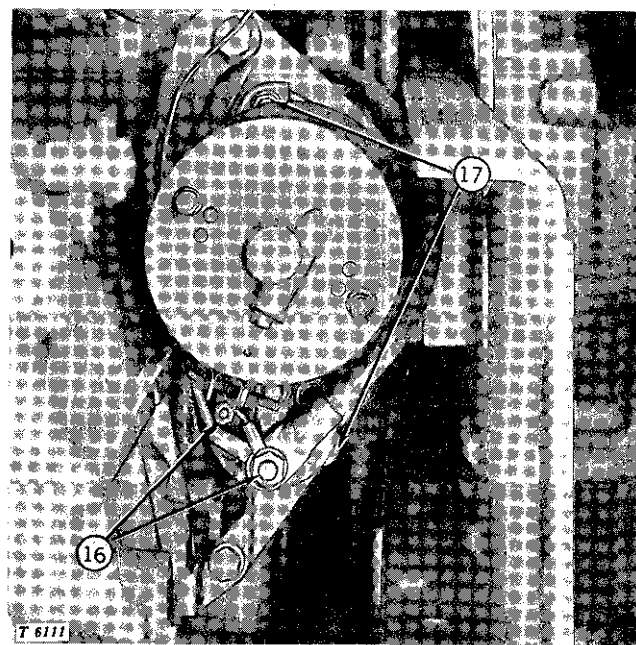

Fig. 20-10-4—Detaching Starter

8. Disconnect air cleaner hose to air intake manifold (diesel tractors) or to carburetor (gasoline tractors).

9. Disconnect water temperature sending unit from water outlet manifold.

10. Remove wiring harness from glow plugs (diesel tractors).

11. Disconnect primer fuel lines (diesel tractors), if tractor is so equipped.

12. Remove fuel filter assembly (diesel tractors).

13. Remove ventilator outlet tube (diesel tractors).

14. Disconnect throttle rod from carburetor (gasoline tractors).

15. Remove manifold to carburetor attaching cap screws and remove carburetor. When removing carburetor, disconnect choke cable (gasoline tractors).

16. Remove battery cable and wiring harness from starter solenoid.

17. Remove two hex. nuts attaching starter to starter adapter housing and lift out starter. Remove adapter.

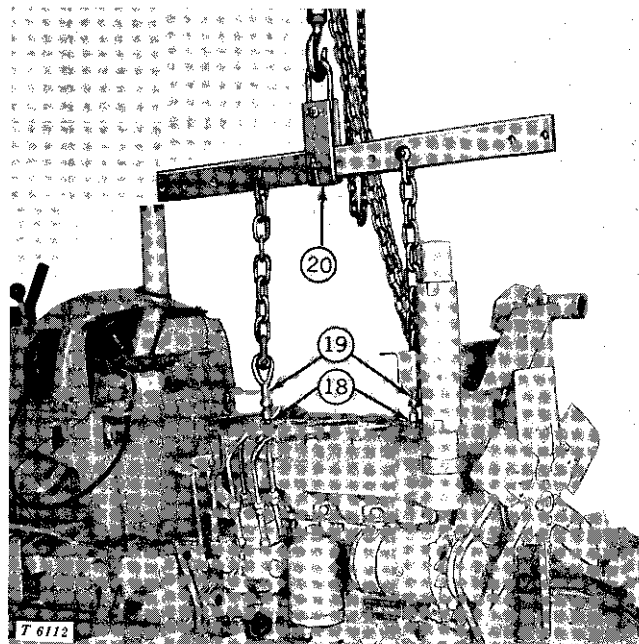

Fig. 20-10-5—Sling for Lifting Engine

18. Install two JD217 adapters in rocker arm cover (diesel tractors). Remove hex nuts from rocker arm cover studs (gasoline tractors).

19. Install two JD218 eyebolts in adapters (diesel tractors) and on studs (gasoline tractors).

20. Place JDG-1 sling on a hoist and attach sling to eyebolts as shown.

Remove cap screws attaching engine flange to clutch housing.

Remove cap screws securing engine rear cover to clutch housing.

Using hoist, pull engine forward off clutch housing mounting. Lift engine from tractor.

### ASSEMBLY

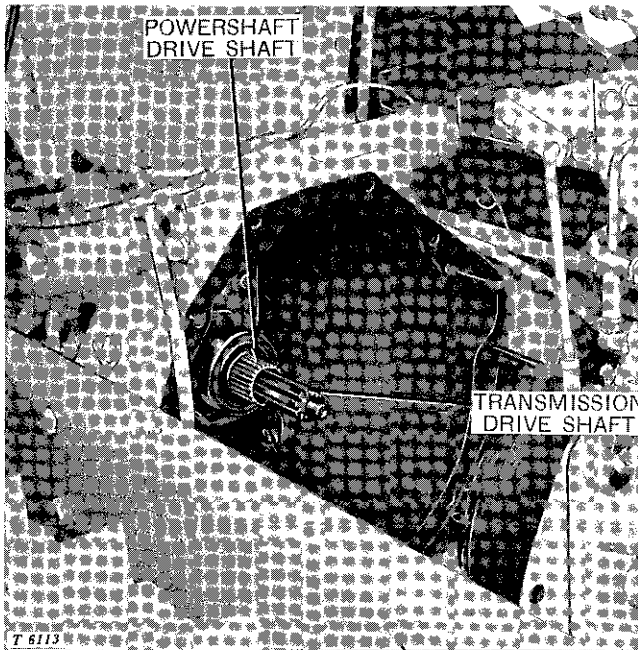

Fig. 20-10-6—Transmission and Powershaft Drive Shaft Indexing Points (Constant Mesh Transmission)

On tractors equipped with a constant mesh transmission, the indexing of the front transmission drive shaft with the driven disk takes place before the indexing of the powershaft drive shaft with the pressure plate as shown in Fig. 20-10-6. Due to the time delay during indexing, it is possible that the powershaft drive shaft might not index with the pressure plate. This will result in breakage of the pressure plate and driven disk.

To install engine correctly, line up studs and cap screws holes of the engine with those of the clutch housing. Bar engine over, holding in a horizontal position and exerting a steady pressure on the engine toward the clutch housing.

**CAUTION:** Engine should index on both shafts and be securely against clutch housing before drawing up studs and cap screws.

Tighten engine to clutch housing hardware securely and remove engine sling.

Install starter and connect battery cable and wiring harness to starter.

Install carburetor and connect choke cable to carburetor and throttle rod to bellcrank (gasoline tractor).

Secure fuel filter with fuel lines to engine and install ventilator outlet tube (diesel tractors). Connect primer fuel lines.

Connect wiring harness to glow plugs (diesel tractors).

Connect water temperature sending unit to water outlet manifold.

Connect air cleaner hose to air intake manifold (diesel tractors) or to carburetor (gasoline tractors).

Connect the wiring to the generator, negative terminal of coil (gasoline tractors), and to the oil pressure sending unit.

Attach throttle control rod to fuel injection pump (diesel tractors). Connect speed control rod (gasoline tractors).

Connect tachometer cable to coupling below the distributor well (gasoline tractors) or the fuel injection pump well (diesel tractors).

Position fuel tank over mounts and secure with hex. nuts.

Connect fuel tank lines and vent tube.

Connect fuel gauge sending unit.

Connect oil cooler lines.

Install front end support, radiator grille housing, and hood (Group 5). Install cowl cover and front bottom plate.

Connect battery ground strap and polarize generator before attempting to start engine.

If engine has been overhauled during removal, a tune-up must be performed as outlined in Section 40.

## Group 15

# SEPARATING TRANSMISSION FROM CLUTCH HOUSING

To separate the tractor between the transmission case and the clutch housing use the following procedure:

- Remove the rear bottom plate.
- Drain the transmission.
- Remove the seat and seat support assembly.
- Remove fenders and footrests.
- Disconnect track (Section 180).
- Remove cap screws attaching rock guards to final drive housing oil pans.
- Remove sprocket shields. Remove bracket caps attaching final drive housing to rear cross-bar.

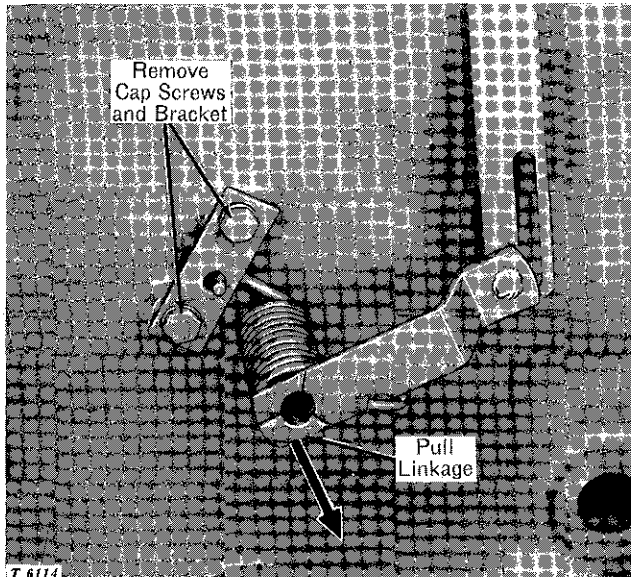

Fig. 20-15-1—Disconnecting Hydraulic Pump

If tractor is equipped with a hydraulic pump disengaging lever, refer to Fig. 20-15-1 and do the following:

Loosen the two cap screws that secure the hydraulic pump disengaging lever retaining spring bracket to the clutch housing and pull linkage out as far as possible.

Disconnect speed change rod from shifter arm on left side of transmission case.

Remove the clamps which secure wiring harness to the transmission top cover.

Disconnect the rear wiring harness and tag for identification.

Disconnect wire leads from starter safety switch.

Remove speed change arm and shaft (refer to Fig. 120-10-6, steps 3, 5, 6, and 7).

Remove the three cap screws that attach the junction block to the top of the clutch housing, if tractor is so equipped. Remove junction block from clutch housing.

If tractor is not equipped with a junction block, remove the three cap screws and plate covering the hole and pull the adapter from the clutch housing.

Remove the cap screws attaching the cowl support to the transmission case.

If tractor is equipped with a constant mesh transmission, remove the clutch housing access plate and remove throw-out bearing return spring. Disconnect oil cooler lines from right side of transmission and remove clamps which secure cooler lines to engine block.

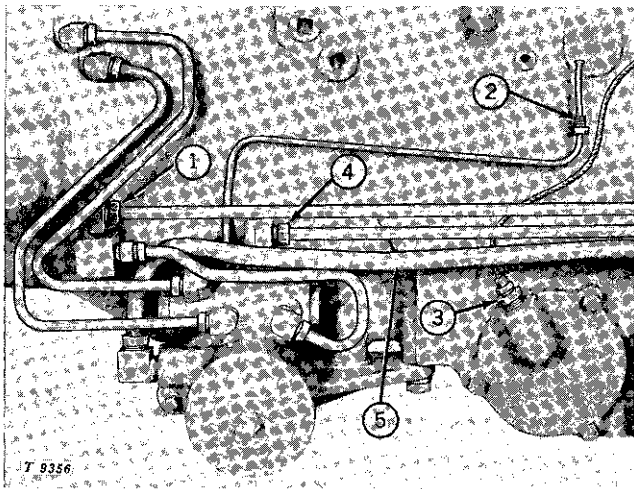

Units ( -45155)

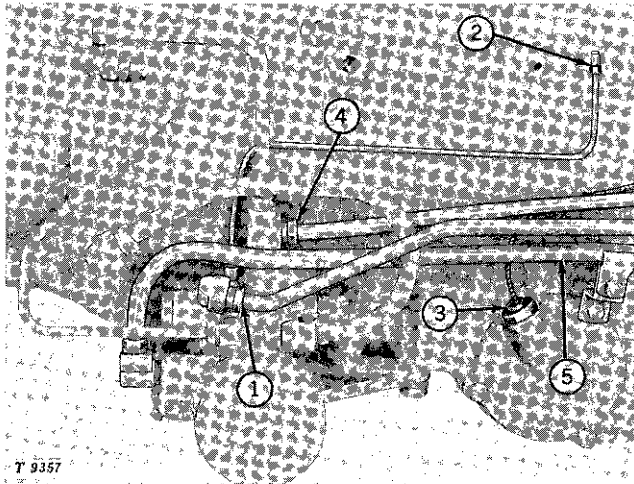

Units (45156-Up)

Fig. 20-15-2—Disconnecting H-L-R Lines

If tractor is equipped with an H-L-R transmission, refer to Fig. 20-15-2 and do the following:

- (1) Disconnect the oil cooler line.
- (2) Separate the oil pressure sending unit line.
- (3) Disconnect the oil temperature sending unit from the oil filter cover.
- (4) Disconnect the oil cooler line from the transmission oil filter.
- (5) Disconnect rear pressure line from elbow in port hole ( -46295) or from flexible front

pressure line in port hole and remove clamp fastening line to clutch housing (46296-up).

On units (46296-up), push flexible line and grommet from port hole cover into clutch housing. Remove port hole cover.

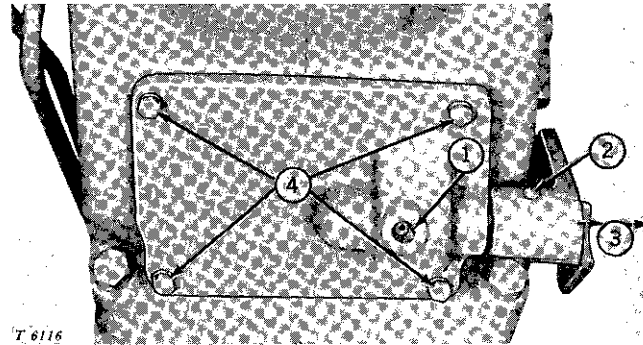

Fig. 20-15-3—Removing Clutch Access Hole Cover

If tractor is equipped with an H-L-R transmission, refer to Fig. 120-15-3 and do the following:

- (1) Remove pipe plug from hole in cover. Place punch through hole and drive out roll pin from clutch disconnect shaft.
- (2) Drive out roll pin and remove arm from end of shaft.
- (3) Pull shaft free of cover.
- (4) Remove cap screws attaching cover and drop cover.

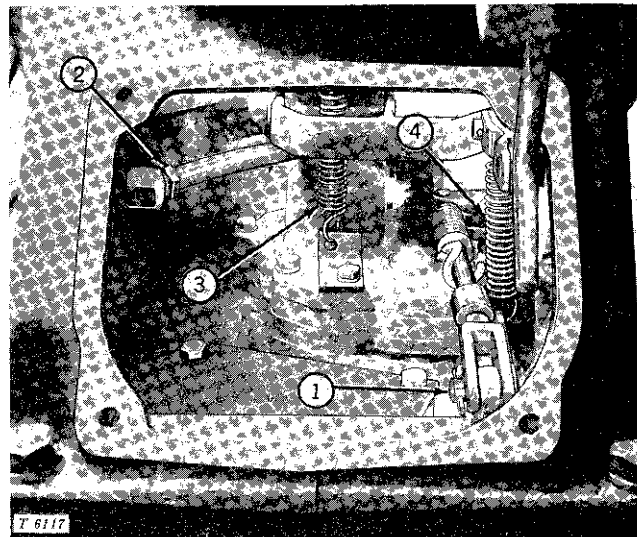

Fig. 20-15-4—Disconnecting Oil Pump Line and Linkage (H-L-R)

If tractor is equipped with H-L-R transmission, refer to Fig. 20-15-4 and do the following:

- (1) Reach through clutch housing access hole and remove cotter pin and pin from linkage.
- (2) On units ( -46295), disconnect front pressure line from port hole connector. Remove port hole cover.
- (3) Remove clutch throw-out spring.
- (4) Remove clutch throw-out yoke spring.

Disconnect the brake rods from the brake operating arms by removing pin and cotter pin.

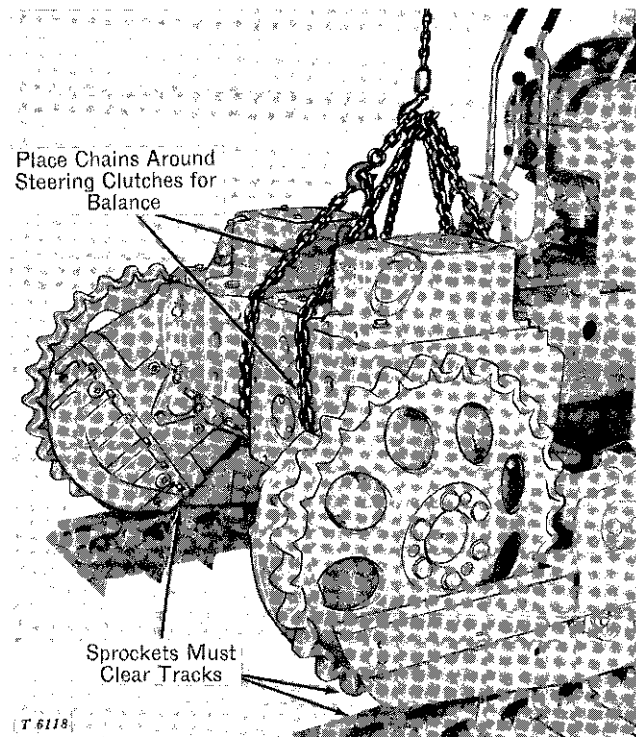

Fig. 20-15-5—Securing Hoist to Transmission Case

Secure hoist to transmission case as shown in Fig. 20-15-5. Raise rear of tractor high enough so that the sprockets clear the track. Place blocking under rear crossbar. Place blocking under grille housing to support engine after the transmission is removed.

**NOTE:** Blocking under grille housing must be secure to prevent tractor from rolling ahead as the transmission is separated.

Remove the cap screws that attach the side frames to the steering clutch housing.

Remove the cap screws and nuts that secure the transmission case to the clutch housing.

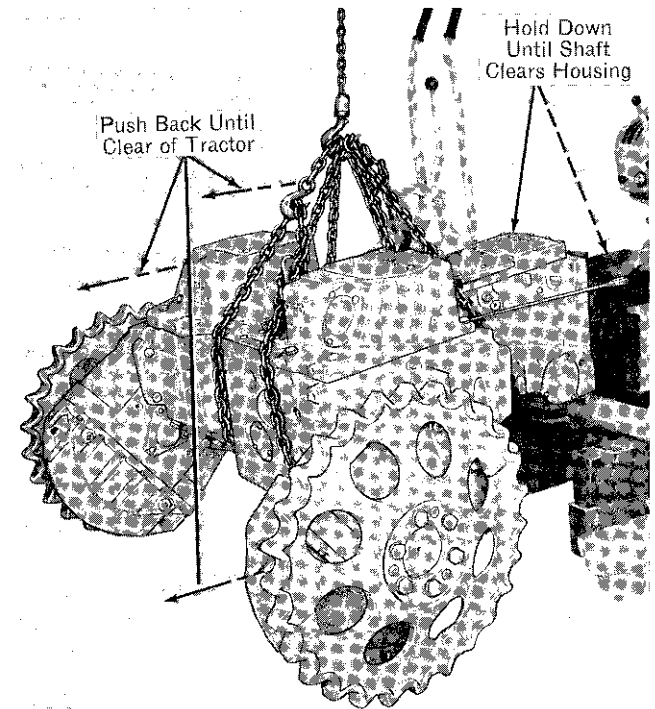

Fig. 20-15-6—Separating Transmission

Using the hoist pull the transmission back and away from the tractor as shown in Fig. 20-15-6.

## ASSEMBLY

Move transmission toward clutch housing until throw-out bearing carrier support tube has passed through clutch yoke far enough to allow installation of bearing and its carrier.

Reach through bottom opening of housing and slide throw-out bearing and carrier onto carrier support tube until carrier is snug against clutch yoke.

Join transmission case to clutch housing. Tighten attaching cap screws to 170 ft-lbs.

**CAUTION:** On tractors with constant-mesh transmission, the indexing of the front transmission drive shaft with the driven disk takes place before the indexing of the powershaft drive shaft with the pressure plate. Due to the time delay during indexing, it is possible that the powershaft drive shaft might not index with the pressure plate. This results in breakage of the pressure plate and driven disk. Make certain that both points are indexed before installing attaching cap screws.

Attach side frames to steering clutch housing and torque cap screws to 275 ft-lbs (3 dashes on head) or to 420 ft-lbs (6 dashes on head).

If tractor is equipped with an H-L-R transmission, refer to Fig. 20-15-4 and perform the following:

(1) Reach through clutch housing access hole and insert pin and cotter pin in linkage.

(2) On units ( -46295), install port hole cover. Connect front pressure line to clutch port hole connector. On units (46296-up), push flexible front pressure line and rubber grommet into place in port hole cover. Lubricate groove in grommet before installing and be sure grommet is seated securely in cover.

(3) Install clutch throw-out spring.

(4) Install clutch throw-out yoke spring.

On tractor with H-L-R transmission, install clutch housing access plate and external linkage (Fig. 20-15-3).

If tractor is equipped with a constant mesh transmission, install clutch throw-out bearing return spring and secure clutch housing access plate with cap screws and lock washers. Connect oil cooler lines to right side of transmission case and secure with clamps to engine block.

Install hydraulic pump disengaging lever, if tractor is so equipped (see Fig. 20-15-1).

Connect speed change rods. Refer to Section 120 or 130 for adjustment.

If tractor is equipped with an H-L-R transmission, refer to Fig. 20-15-2 and perform the following:

(1) Connect oil cooler drain line.

(2) Connect oil pressure sending unit line.

(3) Install oil temperature sending unit to oil filter cover.

(4) Connect oil cooler inlet line to transmission oil filter.

(5) Connect rear pressure line to elbow in port hole cover ( -46295) or, on units (46296-up), to flexible front pressure line on cover, and install clamp on line.

Install adapter and junction block (or plate cover) to clutch housing.

Connect wire leads to starter safety switch.

Secure rear wiring harness to transmission top cover.

Secure cowl to transmission case.

Install bracket caps attaching final drive housing to rear crossbar.

Install cap screws attaching rock guards to final drive housing oil pans.

Install sprocket shields.

Connect track (Section 180). Remove blocking.

Install footrests and fenders.

Install battery, seat support and seat.

Connect rear wiring harness.

Install rear bottom plate.

Fill transmission with the proper quantity and viscosity of oil as recommended in chart in Section 30.

## Group 20

# SEPARATING STEERING CLUTCH HOUSING FROM TRANSMISSION

Remove the final drive as instructed in Group 25 of this Section. Remove fender and seat support.

Remove control housing cover.

Remove brake band adjusting screw, spring, and washer (Fig. 20-20-1).

Disconnect brake linkage (Fig. 20-20-1).

Disconnect foot brake rod from brake operating bellcrank (Fig. 20-20-1).

Unscrew jam nut and adjusting nut and remove clutch operating rod (Fig. 20-20-1).

Remove steering control lever.

Remove the four attaching cap screws and lift off the steering clutch control housing.

Refer to Fig. 150-15-1 and remove cotter pins (A) from throw-out shaft (K). Pull shaft out and remove washers (B) and spring (C).

Remove steering clutch housing drain plug and brake band positioning screw (X and Z, Fig. 150-15-5) as a unit. Slip brake band assembly out of clutch housing.

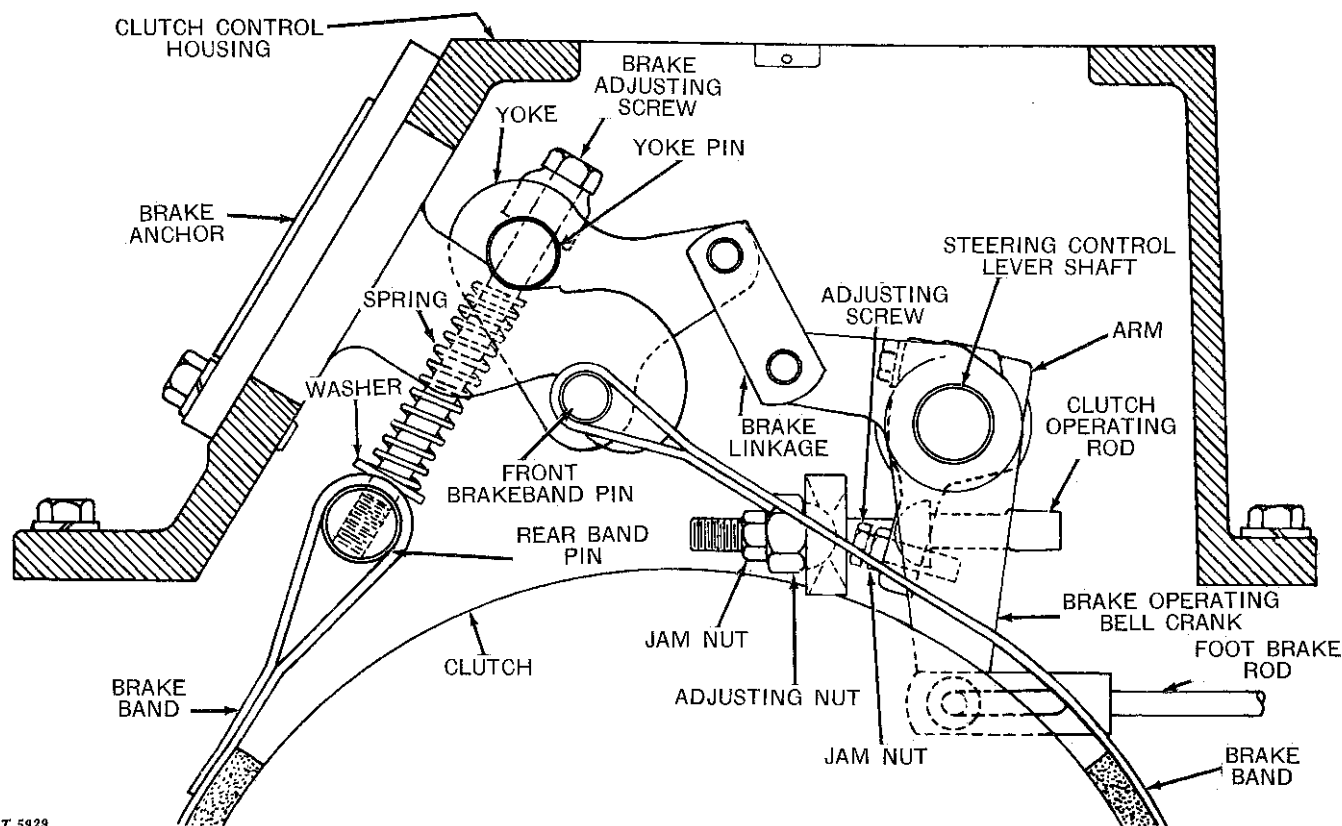

Fig. 20-20-1—Steering Clutch and Brake Controls



Fig. 20-20-2 - Relieving Snap Ring Tension ( -42000)

On tractors ( -42000) remove set screw in end of steering clutch drive shaft in order to relieve tension on the snap ring (Fig. 20-20-2).

Support the steering clutch assembly. This can be done most easily by wrapping heavy wire around the pressure plate fingers and lifting assembly with the wire (after removing clutch drive shaft).

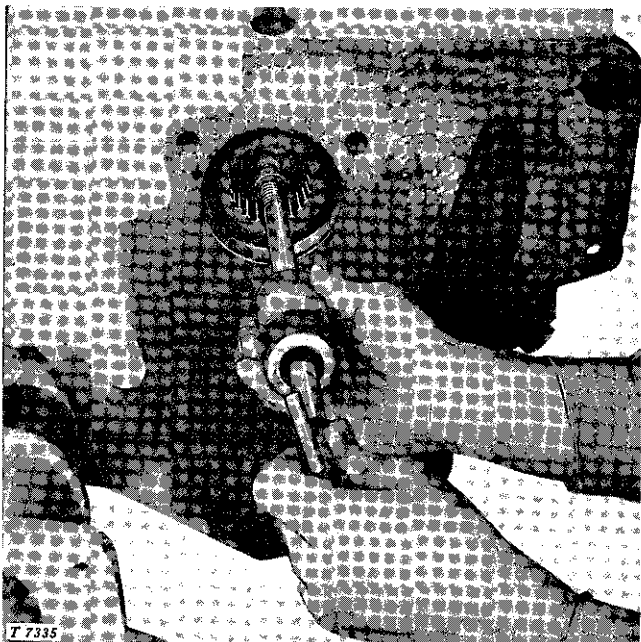

Fig. 20-20-3 - Removing Steering Clutch Drive Shaft

Install puller in end of steering clutch drive shaft and remove shaft (Fig. 20-20-3).

Detach side frame and rear mounted equipment.

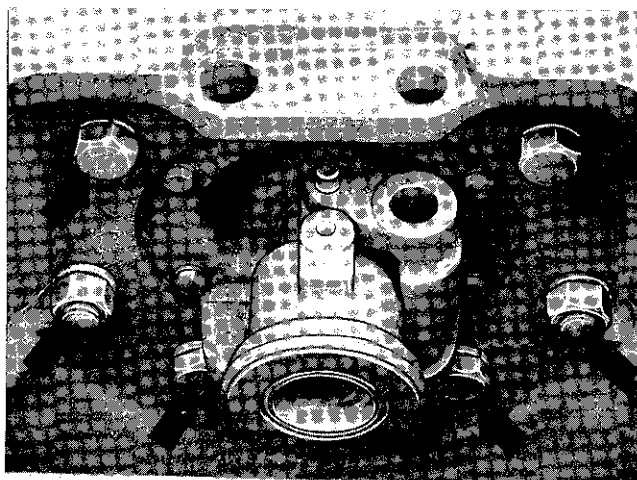

Fig. 20-20-4 - Clutch Throw-Out Bearing Assembly and Housing Attaching Hardware

Slide throw-out bearing and carrier assembly off sleeve. Attach a hoist to the housing and remove housing-to-transmission case hardware (Fig. 20-20-4). Tap housing free from dowels and remove from transmission case.

### INSTALLATION

With the aid of a hoist, position steering clutch housing onto transmission case. Install cap screws and hex. nuts with washers (Fig. 20-20-4) and tighten to 300 foot-pounds.

Attach side frame to housing and tighten cap screws to 275 ft-lbs (3 dashes on heads) or to 420 ft-lbs (6 dashes on heads).

Position clutch throw-out bearing and carrier on sleeve (Fig. 20-20-4).

Place steering clutch in housing and support clutch assembly so that steering clutch drive shaft can be inserted. Insert drive shaft (Fig. 20-20-3). On tractors ( -42000), be sure that snap ring on end of shaft covers all three expander pins. Also on tractors ( -42000), install snap ring as described at top of next page.

Push shaft into position making certain that snap ring is able to seat to groove in clutch hub. Hold shaft in position against spring in ring gear hub and tighten set screw securely (Fig. 20-20-2).

Slip brake band into housing and position on brake drum so that band positioning slot on bottom of brake band assembly is lined up with center of plug hole in bottom of steering clutch housing. Install plug, brake band positioning screw, and positioning screw adjusting washers (X, Z, and Y, Fig. 150-15-5).

If brake lining has been replaced or if a new brake band assembly has been installed, reset band positioning cap screw as follows:

Screw band positioning cap screw (without adjusting washers) through plug until screw pushes brake band tight against brake drum. Determine number of washers (Y, Fig. 150-15-5), required to fill gap between drain plug and positioning screw head. Add one more washer to this number of washers and install between drain plug and positioning screw head.

Install clutch throw-out shaft (with spring and washers) in yoke so that lever at top of throw-out shaft is perpendicular to yoke arms. Insert new cotter pins. Hook spring over pin on throw-out bearing yoke.

Install clutch control housing on clutch housing with a new gasket and tighten cap screws.

Install clutch operating rod with adjusting nut and jam nut (Fig. 20-20-1).

Hook front brake band pin under brake anchor and install yoke pin through yoke (Fig. 20-20-1).

Insert brake adjusting screw through yoke pin, slide spring and washer onto adjusting screw, and start adjusting screw into tapped hole in rear band pin (Fig. 20-20-1).

Connect brake linkage.

Install pin with washer and cotter pin to connect foot brake rod yoke to brake operating bell-crank (Fig. 20-20-1). Use a magnet to recover any parts which may be accidentally dropped into the clutch housing.

Replace final drive parts as instructed in Group 25 of this Section.

Adjust steering clutch, steering brake, and foot brake as instructed in Group 5 of Section 150.

Replace control housing cover with gasket.

Connect track and adjust tension (Section 180).

Replace seat, fender, and rear mounted equipment.

## Group 25

# SEPARATING FINAL DRIVE FROM STEERING CLUTCH HOUSING

Remove sprocket shield from track frame.  
Disconnect track (Section 180).

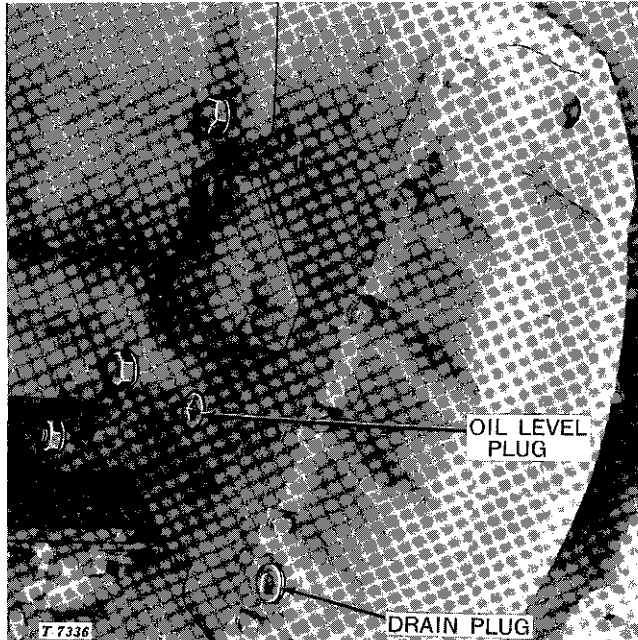

Fig. 20-25-1—Final Drive Drain Plug

Drain final drive (Fig. 20-25-1).

Loosen attaching cap screws at front and rear  
crossbars. Remove cap screw attaching rock  
guard to final drive oil pan. Block up side of  
tractor and pry out track frame as far as pos-  
sible.

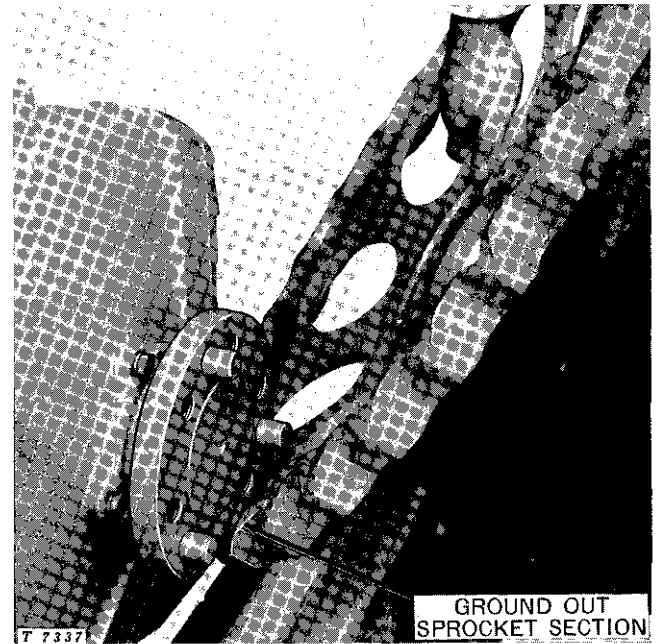

Fig. 20-25-3—Removing Drive Sprocket

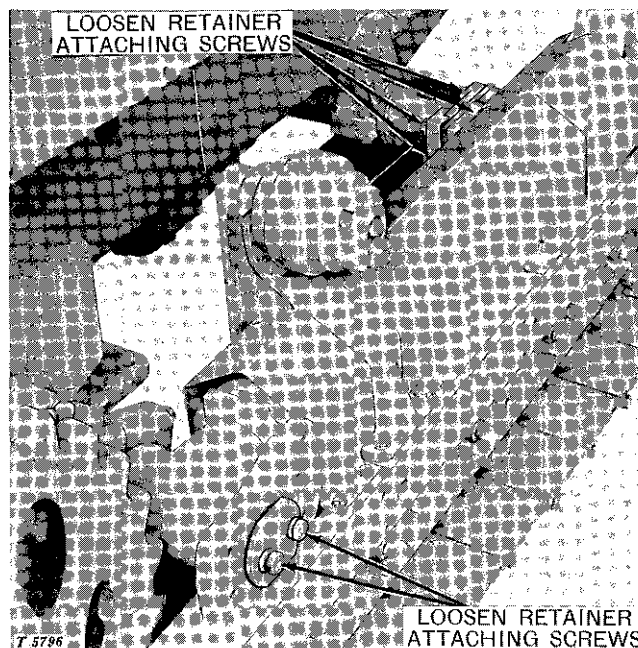

Fig. 20-25-2—Attaching Screws on Cross Bars

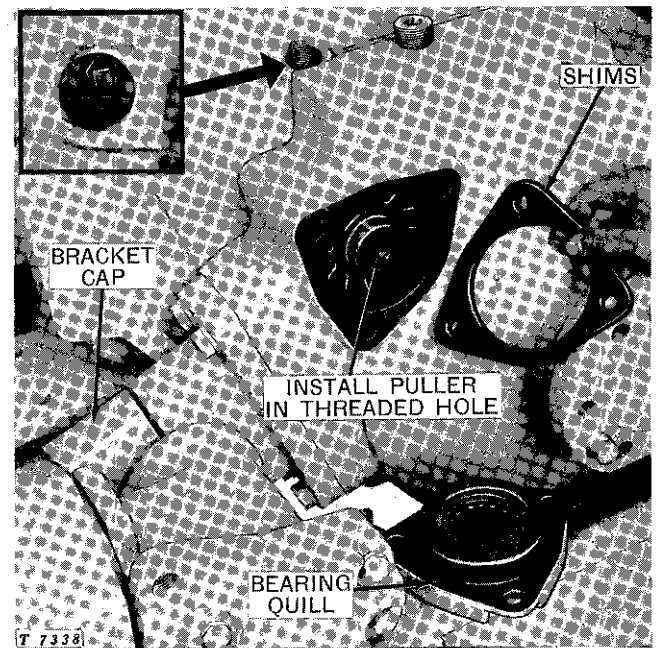

Fig. 20-25-4—Final Drive Housing

Remove the cap screws attaching track drive sprocket to the flanged axle. Tap drive sprocket free from dowels. Rotate sprocket so that notch clears flanged axle (Fig. 20-25-3) and remove sprocket.

Remove bracket cap which attaches final drive housing to rear crossbar (Fig. 20-25-4).

Remove large pipe plug from steering clutch housing (Fig. 20-25-4). Rotate steering clutch until set screw is visible in steering clutch opening. Back off lock nut and loosen, but do not remove set screw.

Remove the three long cap screws and pull out the bearing quill (Fig. 20-25-4).

Install suitable puller in threaded center hole of final drive pinion shaft (Fig. 20-25-4). Remove shaft carefully to avoid damage to the inner oil seal.

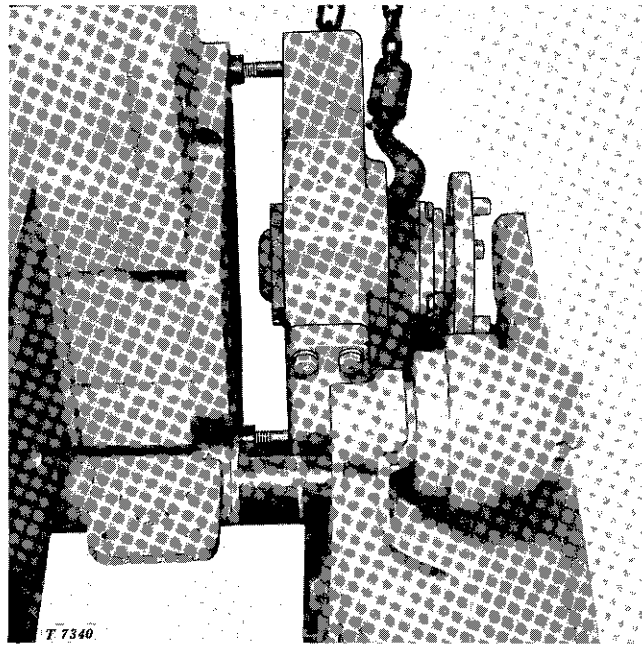

Fig. 20-25-6—Removing Final Drive Housing

Support housing with hoist and separate housing from steering clutch housing (Fig. 20-25-6).

### INSTALLATION

Before installing final drive housing on tractor, install final drive pinion shaft in housing and determine the number of shims necessary behind quill to obtain .004 to .013-inch end play. Then remove final drive pinion shaft and proceed with installation.

NOTE: If tractor is equipped with T14361T Quill, it may be necessary to install new style quill to obtain proper end play.

Support final drive housing with hoist and move into position.

Install the attaching cap screws and hex. nuts on the inner side of the final drive housing (Fig. 20-25-5). Tighten to 170 foot-pounds.

Install bracket cap which attaches final drive housing to the rear crossbar.

Make certain that spacer (Fig. 20-25-7) is positioned on end of steering clutch shaft (raised shoulder to the outside).



Fig. 20-25-5—Inner Attaching Screws

Remove the attaching cap screws and hex. nuts on the inner side of the final drive housing (Fig. 20-25-5).



**Suggest:**

**If the above button click is invalid.**

**Please download this document**

**first, and then click the above link**

**to download the complete manual.**

**Thank you so much for reading**

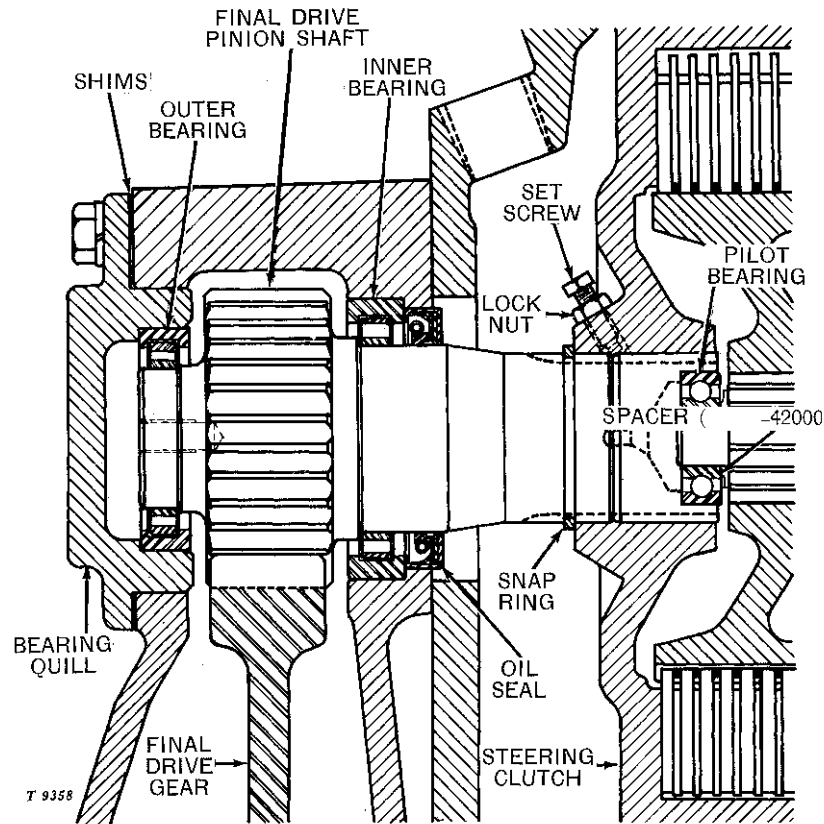

Fig. 20-25-7—Final Drive and Pinion Shaft Installed

**NOTE:** This spacer is not used on units (42001-up).

Fill bearing bore in end of final drive pinion shaft (Fig. 20-25-7) half full of high temperature grease and coat pinion and bearing surfaces with oil. Carefully insert pinion shaft with snap ring through final drive housing and pinion shaft oil seal, and on into steering clutch. Do not force the pinion shaft into position as forcing the shaft could damage the oil seal and misalign the bearings.

**CAUTION:** Do not allow snap ring to drag across seal lip when installing pinion shaft. To accomplish this, use a puller installed in the threaded hole as an aid in guiding the pinion shaft.

Tap pinion shaft into final position with a soft hammer, making sure that snap ring on shaft is seated against steering clutch brake drum (Fig. 20-25-7).

Tighten set screw securely and lock in place with lock nut (Fig. 20-25-7).

Replace large pipe plug in steering clutch housing and tighten securely.

Install calculated number of shims (page 20-25-2) on bearing quill (Fig. 20-25-7) and coat bearing with oil. Insert quill into final drive housing. Install mounting cap screws and tighten to 170 foot-pounds.

Position drive sprocket on flanged axle dowels and tap into place. Install the attaching cap screws and tighten to 300 foot-pounds.

Tighten track frame attaching screws at front and rear crossbars (Fig. 20-25-2). Attach rock guard to final drive oil pan.

Connect and adjust the track (Section 180). Replace sprocket shield.

Fill the final drive housing to proper oil level (Section 30). Be sure all pipe plugs are securely tightened into final drive housing (Fig. 20-25-1).

**<https://www.ebooklibonline.com>**

Hello dear friend!

Thank you very much for reading.

Enter the link into your browser.

The full manual is available for immediate download.

**<https://www.ebooklibonline.com>**