

# 850, 900HC, 950 and 1050 Tractors



JOHN DEERE

## TECHNICAL MANUAL

850, 900HC, 950 and 1050  
Tractors

TM1192 (01AUG86) English

John Deere  
Lawn & Grounds Care Division  
TM1192 (01AUG86)

LITHO IN U.S.A.  
ENGLISH





# 850, 900HC, 950 AND 1050 TRACTORS

## Technical Manual

### TM-1192 (Aug-86)

#### SECTION AND GROUP CONTENTS

##### SECTION 10 - GENERAL

- Group 00 - Specifications and Special Tools
- Group 05 - Predelivery, Delivery, and After-Sale Services—850 and 950 Tractors
- Group 06 - Predelivery, Delivery, and After-Sale Services—1050 Tractor
- Group 10 - Tune-Up
- Group 15 - Lubrication
- Group 20 - Separation

##### SECTION 20 - ENGINE REPAIR

- Group 00 - Specifications and Special Tools
- Group 05 - Cylinder Head, Valves, and Camshaft—850 and 950 Tractors
- Group 06 - Cylinder Head, Valves, and Camshaft—1050 Tractor
- Group 10 - Cylinder Block, Liners, Pistons and Rods
- Group 15 - Crankshaft, Main Bearings, and Flywheel
- Group 20 - Lubrication System
- Group 25 - Cooling System—850 and 950 Tractors\*
- Group 26 - Cooling System—850, 950, and 1050 Tractors\*\*

##### SECTION 30 - FUEL AND AIR REPAIR

- Group 00 - Specifications and Special Tools
- Group 05 - 850 and 950 Air Intake System
- Group 06 - 1050 Air Intake System
- Group 10 - Diesel Fuel System
- Group 15 - 850 and 950 Control Linkage\*
- Group 16 - 850, 950, and 1050 Control Linkage\*\*

##### SECTION 40 - ELECTRICAL REPAIR

- Group 00 - Specifications and Special Tools
- Group 05 - General Information
- Group 10 - Charging System
- Group 15 - Starting Circuit
- Group 20 - Lighting and Accessory Circuits

##### SECTION 50 - POWER TRAIN REPAIR

- Group 00 - Specifications and Special Tools
- Group 05 - Engine and Clutch Linkage—850 ( -16000) and 950 ( -20000) Tractors

\*850 ( -009000), 950 ( -012000)

\*\*850 (009001- ), 950 (012001- )

##### SECTION 50—POWER TRAIN REPAIR—Continued

- Group 06 - Engine and Clutch Linkage 850 (16001- ), 950 (20001- ) and 1050 Tractor
- Group 10 - Sliding Gear Transmission 850 ( -16000) and 950 ( -20000) Tractors
- Group 11 - Sliding Gear Transmission 850 (16001- ), 950 (20001- ) and 1050 Tractor
- Group 15 - PTO 850 ( -16000) and 950 ( -20000) Tractors
- Group 16 - PTO 850 (16001 ), 950 (20001- ) and 1050 Tractor
- Group 20 - Differential 850 ( -16000) and 950 ( -20000) Tractors
- Group 21 - Differential 850 (16001- ), 950 (20001- ) and 1050 Tractor
- Group 25 - Final Drive—850-950 Tractors
- Group 26 - Final Drive—1050 Tractor
- Group 27 - Drop Housings and Final Drives—900HC Tractor
- Group 30 - Mechanical Front-Wheel Drive

##### SECTION 60 - STEERING/BRAKES REPAIR

- Group 00 - Specifications and Special Tools
- Group 05 - Steering
- Group 10 - Power Steering
- Group 15 - Brakes

##### SECTION 70 - HYDRAULIC REPAIR

- Group 00 - Specifications and Special Tools
- Group 05 - Hydraulic Pump and Oil Filters
- Group 10 - 850/950 Rockshaft and Implement Hitches
- Group 15 - 1050 Rockshaft and Implement Hitches
- Group 20 - Selective Control Valve

##### SECTION 80 - MISCELLANEOUS REPAIR

- Group 00 - Specifications and Special Tools
- Group 05 - Front Axle Assembly
- Group 10 - Wheels

COPYRIGHT© 1986 DEERE & COMPANY

Moline, Illinois  
All rights reserved  
Previous Edition  
Copyright © 1984  
Copyright © 1980  
Copyright © 1979  
Copyright © 1978  
Copyright © 1977  
DEERE & COMPANY

**<https://www.ebooklibonline.com>**

Hello dear friend!

Thank you very much for reading.

Enter the link into your browser.

The full manual is available for immediate download.

**<https://www.ebooklibonline.com>**

## SECTION AND GROUP CONTENTS—Continued

- SECTION 90 - OPERATOR STATION REPAIR  
 Group 00 - Specifications and Special Tools  
 Group 05 - ROLL-GARD®  
 Group 10 - Canopy
- SECTION 220 - ENGINE OPERATION AND TESTS  
 Group 00 - Specifications and Special Tools  
 Group 05 - System Operation  
 Group 10 - System Tests and Diagnosis
- SECTION 230 - FUEL/AIR OPERATION AND TESTS  
 Group 00 - Specifications and Special Tools  
 Group 05 - 850 and 950 Air Intake System  
 Group 06 - 1050 Air Intake System  
 Group 10 - Diesel Fuel System  
 Group 15 - Speed Control Linkage—850 and 950 Tractors\*  
 Group 16 - Speed Control Linkage—850, 950, and 1050 Tractors\*\*
- SECTION 240 - ELECTRICAL OPERATION AND TESTS  
 Group 00 - Specifications and Special Tools  
 Group 05 - General Information and Diagrams  
 Group 10 - Charging System Diagnosis  
 Group 15 - Starting Circuit Diagnosis  
 Group 20 - Lighting and Accessory Circuits
- SECTION 250 - POWER TRAIN OPERATION AND TESTS  
 Group 00 - Specifications and Special Tools  
 Group 05 - Clutch and Transmission Operation—850 ( -16000) and 950 ( -20000) Tractors  
 Group 06 - Clutch and Transmission Operation—850 (16001- ), 950 (20001- ) and 1050 Tractor  
 Group 10 - Trouble Shooting the Clutch, Transmission and PTO—850 ( -16000) and 950 ( -20000) Tractors  
 Group 11 - Trouble Shooting the Clutch, Transmission and PTO—850 (16001- ), 950 (20001- ) and 1050 Tractor  
 Group 15 - Differential and Final Drive—850 ( -16000) and 950 ( -20000) Tractors  
 Group 16 - Differential and Final Drive—850 (16001- ), 950 (20001- ) and 1050 Tractor  
 Group 20 - Mechanical Front-Wheel Drive

### SECTION 260 - STEERING/BRAKES OPERATION AND TESTS

- Group 00 - Specifications and Special Tools  
 Group 05 - Steering  
 Group 10 - Power Steering  
 Group 15 - Brakes

### SECTION 270 - HYDRAULIC OPERATION AND TESTS

- Group 00 - Specifications and Special Tools  
 Group 05 - Hydraulic System Operation  
 Group 10 - Hydraulic System Tests and Diagnosis  
 Group 15 - Hydraulic Pump  
 Group 20 - 850/950 Rockshaft and Implement Hitches  
 Group 25 - 1050 Rockshaft and Implement Hitches  
 Group 30 - Selective Control Valve



This tractor is of metric design. All hardware is therefore metric. Make sure you use the specified metric hardware when replacement becomes necessary. For your convenience most specifications are given in customary U.S. measurement with metric measurement following. Some specifications cannot be converted. Those appear in metric only.

*All information, illustrations and specifications contained in this technical manual are based on the latest information available at the time of publication. The right is reserved to make changes at any time without notice.*

\*850 ( -009000), 950 ( -012000)

\*\*850 (009001- ), 950 (012001- )

# Section 10 GENERAL

## CONTENTS OF THIS SECTION

	Page		Page
GROUP 00 - SPECIFICATIONS		Group 10 - TUNE-UP	
General Tractor Specifications		Preliminary Engine Testing .....	10-1
850 and 950 Tractors .....	00-1	Tune-Up .....	10-1
1050 Tractors .....	00-3	Operation .....	10-5
Predelivery .....	00-4	General .....	10-5
Tune-Up .....	00-6	GROUP 15 - LUBRICATION	
Lubrication .....	00-6	Lubricants .....	15-1
Separation .....	00-7	Engine .....	15-2
Special Tools .....	00-8	Transmission-Hydraulic System .....	15-3
GROUP 05 - PREDELIVERY, DELIVERY, AND AFTER-SALE SERVICES 850 AND 950 TRACTORS		Front Wheel Bearings .....	15-5
Before Starting Tractor .....	05-1	Grease Fittings .....	15-7
Predelivery Services .....	05-4	GROUP 20 - SEPARATION	
Delivery Services .....	05-13	Removing Front End (850-950) .....	20-1
After-Sale Services .....	05-14	(1050) .....	20-6
GROUP 06 - PREDELIVERY, DELIVERY, AND AFTER-SALE SERVICES 1050 TRACTOR		Separating Front End from Clutch Housing (850-950) .....	20-2
Before Starting Tractor .....	06-1	(1050) .....	20-8
Predelivery Services .....	06-5	Engine Removal (850-950) .....	20-4
Delivery Services .....	06-11	(1050) .....	20-10
After-Sale Services .....	06-12	Separating Clutch Housing from Transmission .....	20-12
		Removing Rear Axle Housing .....	20-14

### Group 00

## SPECIFICATIONS AND SPECIAL TOOLS GENERAL TRACTOR SPECIFICATIONS (850-950)

	850 TRACTOR	950 TRACTOR
HORSEPOWER (Official PTO horsepower)	16.61 kW (22.27 hp) at 2600 rpm	20.40 kW (27.36 hp) at 2400 rpm
ENGINE:		
Type	3-cylinder, in-line, valve-in-head, diesel	3-cylinder, in-line, in-line, valve-in-head, diesel
Slow idle speed	800 rpm	800 rpm
Working speed range	1900 to 2600 rpm	1700 to 2400 rpm
Bore and stroke	80 x 85 mm (3.15 x 3.35 in.)	90 x 90 mm (3.54 x 3.54 in.)
Displacement	1.3 L (78 cu-in)	1.7 L (105 cu-in)
Compression ratio	21 to 1	20 to 1
Firing order (No. 1 in rear)	1-3-2	1-3-2
Valve clearance		
Intake	0.20 mm (0.008 in.)	0.15 mm (0.006 in.)
Exhaust	0.20 mm (0.008 in.)	0.15 mm (0.006 in.)

## SPECIFICATIONS (850 and 950)—Continued

	850	950
Injection pump timing	26° BTDC	25° BTDC
Lubrication system	force-feed, pressurized with full-flow filter	force-feed, pressurized with full-flow filter
<b>FUEL SYSTEM:</b>		
Type	precombustion chamber	precombustion chamber
Injection pump type	plunger	plunger
Air cleaner	dry type	dry type
<b>COOLING SYSTEM:</b>		
Type	pressurized with centrifugal pump	pressurized with centrifugal pump
Temperature control	heavy duty thermostat	heavy duty thermostat
<b>CAPACITIES</b>		
Fuel tank	32 L (8.5 U.S. gal.)	32 L (8.5 U.S. gal.)
Cooling system	5.5 L (6 U.S. qt.)	6 L (6.5 U.S. qt.)
Crankcase (with filter change)	4.5 L (5 U.S. qt.)	6.4 L (7 U.S. qt.)
Transmission-hydraulic system		
850 ( -16000) and 950 ( -20000)	18 L (19 U.S. qt.)	18 L (19 U.S. qt.)
850 (16001- ) , 950 (20001- )		
2WD	20 L (21 U.S. qt.)	20 L (21 U.S. qt.)
850 (16001- ) , 950 (20001- )		
MFWD	22 L (23 U.S. qt.)	22 L (23 U.S. qt.)
MFWD Axle	6.5 L (6.9 U.S. qt.)	8.5 L (9 U.S. qt.)
<b>TRANSMISSION:</b>		
Type	2-speed range selector and 4-speed gear selector	2-speed range selector and 4-speed gear selector
Gear selections	8 forward and 2 reverse	8 forward and 2 reverse
Clutch		
850 ( -16000) and 950 ( -20000)	single-disk, dry	single-disk, dry
850 (16001- ) and 950 (20001- )	two-stage transmission clutch	two-stage transmission clutch
<b>POWER TAKE-OFF:</b>		
Type		
850 ( -16000) and 950 ( -20000)	transmission driven, with overrunning clutch	transmission driven, with overrunning clutch
850 (16001- ) and 950 (20001- )	continuous running clutch	continuous running clutch
Speed (2260 engine rpm)	540 rpm	540 rpm
Size	35 mm (1-3/8 in.)	35 mm (1-3/8 in.)
Clutch		
850 ( -16000) and 950 ( -20000)	uses transmission clutch	uses transmission clutch
850 (16001- ) and 950 (20001- )	two-stage transmission clutch	two-stage transmission clutch
<b>HYDRAULIC SYSTEM:</b>		
Type	open center, constant flow	open center, constant flow
Working pressure	13 790 kPa (138 bar) (2000 psi)	13 790 kPa (138 bar) (2000 psi)
Pump	gear pump, driven by engine	gear pump, driven by engine
<b>BRAKES</b>		
Type	mechanical dry, internal expanding shoe	mechanical, dry, internal expanding shoe
<b>ELECTRICAL SYSTEM:</b>		
Type	12-volt, negative ground	12-volt, negative ground
Battery	one, 12-volt, BCI group 30H, 475 amps cold cranking, 160 minutes reserve capacity	one, 12-volt, BCI group 30H, 475 amps cold cranking, 160 minutes reserve capacity
Alternator	25-amp	25-amp
<b>TIRES AND TREADS:</b>		
	See pages 05-6 and 05-7 in this section.	See pages 05-6 and 05-7 in this section.

	850	950
<b>DIMENSIONS:</b>		
Wheelbase	850 ( -16000) 1.63 m (64 in.) 850 (16001- ) 1.7 m (67.5 in.)	1.75 m (69 in.)
Overall length	850 ( -16000) 2.29 m (118 in.) 850 (16001- ) 3.07 m (121 in.)	3.10 m (122 in.)
Height to muffler cover*	2.18 m (85.8 in.)	2.28 m (89.6 in.)
Height to top of ROLL-GARD® Canopy*	2.06 m (81.1 in.)	2.13 m (84.0 in.)
Overall width (minimum tread)	1.35 m (53 in.)	2.48 m (58 in.)
Turning radius	2.80 m (110 in.)	2.99 m (118 in.)
<b>SHIPPING WEIGHT**</b>	1065 kg (2350 lbs.)	1200 kg (2650 lbs.)

\*850 Tractor equipped with 11.2-24 rear tires and 5.00-15 front tires. 950 Tractor equipped with 12.4-28 rear tires and 5.50-16 front tires.

\*\*Equipped for average field service, without fuel and ballast.

TRAVEL SPEEDS:*		850 Tractor		950 Tractor	
Gear	Rated Engine Speed (2600 rpm)	Standard PTO Speed (2260 rpm)	Rated Engine Speed (2400 rpm)	Standard PTO Speed (2260 rpm)	
1	1.3 km/h 0.8 mph	1.1 km/h 0.7 mph	1.3 km/h 0.8 mph	1.2 km/h 0.8 mph	
2	1.8 km/h 1.1 mph	1.6 km/h 1.0 mph	1.9 km/h 1.2 mph	1.8 km/h 1.1 mph	
3	2.7 km/h 1.7 mph	2.4 km/h 1.5 mph	2.8 km/h 1.7 mph	2.6 km/h 1.6 mph	
4	4.0 km/h 2.5 mph	3.5 km/h 2.2 mph	4.1 km/h 2.6 mph	3.9 km/h 2.4 mph	
5	6.0 km/h 3.8 mph	5.2 km/h 3.3 mph	6.2 km/h 3.9 mph	5.9 km/h 3.7 mph	
6	8.6 km/h 5.4 mph	7.5 km/h 4.7 mph	8.9 km/h 5.5 mph	8.4 km/h 5.2 mph	
7	12.7 km/h 8.0 mph	11.1 km/h 6.9 mph	13.1 km/h 8.2 mph	12.3 km/h 7.7 mph	
8	18.7 km/h 11.7 mph	16.3 km/h 10.2 mph	19.3 km/h 12.1 mph	18.2 km/h 11.4 mph	
1R	1.8 km/h 1.1 mph	1.6 km/h 1.0 mph	1.9 km/h 1.2 mph	1.8 km/h 1.1 mph	
2R	8.6 km/h 5.4 mph	7.5 km/h 4.7 mph	8.9 km/h 5.5 mph	8.4 km/h 5.2 mph	

\*850 Tractor equipped with 11.2-24 rear tires. 950 Tractor equipped with 12.4-28 rear tires.

## GENERAL TRACTOR SPECIFICATIONS (1050)

**HORSEPOWER** (Factory observed PTO horsepower)

24.6 kW (33 hp) at 2400 rpm

**ENGINE:**

Type	3-cylinder, in-line, valve-in-head, turbocharged diesel
Slow idle speed	800 rpm
Working speed range	1700 to 2400 rpm
Bore and stroke	90 x 90 mm (3.54 x 3.54 in.)
Displacement	1717 cm <sup>3</sup> (105 cu-in)
Compression ratio	21 to 1
Firing order (No. 1 in rear)	1-3-2
Valve clearance	
Intake	0.15 mm (0.006 in.)
Exhaust	0.15 mm (0.006 in.)
Injection pump timing	25° BTDC
Lubrication system	force-feed, pressurized with full-flow filter

## SPECIFICATIONS (1050)—Continued

### FUEL SYSTEM:

Type	precombustion chamber
Injection pump type	plunger
Air cleaner	dry type with secondary element

### COOLING SYSTEM:

Type	pressurized with centrifugal pump
Temperature control	heavy duty thermostat

### CAPACITIES:

Fuel tank	42 L (11 U.S. gallons)
Cooling system	6.7 L (7.5 U.S. quarts)
Crankcase (with filter change)	6.4 L (7 U.S. quarts)
Transmission-hydraulic system	26 L (7 U.S. gallons)
Front axle housing	8.5 L (9 U.S. quarts)

### TRANSMISSION:

Type	2-speed range selector and 4-speed gear selector
Gear selections	8 forward and 2 reverse
Clutch	two-stage, dry

### POWER TAKE-OFF:

Type	continuous running
Speed (2260 engine rpm)	540 rpm
Size	35 mm (1-3/8 in.)
Clutch	uses two-stage transmission clutch

### HYDRAULIC SYSTEM:

Type	open center, constant flow
Working pressure	13800 kPa (138 bar) (2000 psi)
Pump	gear pump, driven by engine

### BRAKES:

Type	mechanical, dry, internal expanding shoe
------	--

### ELECTRICAL SYSTEM:

Type	12-volt, negative ground
Battery	one, 12-volt, BCI group 30H, 475 amps cold cranking, 160 minutes reserve capacity
Alternator	25-amp

### TIRES AND TREADS:

See pages 06-6 and 06-7 in this section.

DIMENSIONS:

Wheelbase .....	1750 mm (69 in.)
Overall length (with 3-point hitch) .....	3100 mm (122 in.)
Height to muffler cover* .....	1970 mm (78 in.)
Height to top of ROLL-GARD canopy* .....	2180 mm (86 in.)
Overall width (minimum tread) .....	1650 mm (65 in.)
Turning radius .....	3100 mm (122 in.)

SHIPPING WEIGHT\*\* ..... 1350 kg (3000 lbs.)

*\*Tractor equipped with 13.6 - 28 rear tires and 6.00 - 16 front tires.*

*\*\*Equipped for average field service, without fuel and ballast.*

TRAVEL SPEEDS:\*

Gear	km/h	mph
1st	1.37	.85
2nd	1.96	1.22
3rd	2.89	1.80
4th	4.28	2.66
5th	6.45	4.00
6th	9.20	5.72
7th	13.60	8.45
8th	20.10	12.50
1 R	1.96	1.22
2 R	9.20	5.72

*\*1050 Tractor equipped with 13.6 - 28 rear tires and engine at rated speed of 2400 rpm (575 PTO rpm).*

## Tune-Up

ITEM	SPECIFICATION
PTO Horsepower	
850 .....	16.4 kW (22 hp)
950 .....	20.1 kW (27 hp)
1050 .....	24.6 kW (33 hp)
Compression .....	2916-4405 kPa (39.1-44.0 bar) (568 to 639 psi)
Thermostat opening temperature .....	71°C (160°F)
Radiator cap pressure release .....	98 kPa (1.0 bar) (14 psi)
Engine speeds	
850	
Slow idle .....	800 rpm
Fast idle .....	2700 rpm
Rated speed at full load .....	2600 rpm
950	
Slow idle .....	800 rpm
Fast idle .....	2600 rpm
Rated speed at full load .....	2400 rpm
1050	
Slow idle .....	800 rpm
Fast idle .....	2575 rpm
Rated speed at full load .....	2400 rpm

## Lubrication

Engine crankcase oil capacity	
850 .....	4.5 L (5 U.S. quarts)
950 .....	6.4 L (7 U.S. quarts)
1050 .....	6.4 L (7 U.S. quarts)
Transmission-hydraulic system capacity	
850 ( -16000) and 950 ( -20000) 2WD .....	18 L (19 U.S. quarts)
850 (16001- ) and 950 (20001- ) 2WD .....	20 L (21 U.S. quarts)
850 (16001- ) and 950 (20001- ) MFWD .....	22 L (23 U.S. quarts)
1050 (All) .....	27 L (28.5 U.S. quarts)
MFWD axle housing capacity	
850 .....	6.5 L (6.9 U.S. quarts)
950 and 1050 .....	8.5 L (8.9 U.S. quarts)
Service intervals	
Check engine oil level .....	Every 10 hours
Change engine oil .....	After first 50 hours then Every 100 hours
Replace engine oil filter .....	Every 200 hours
Clean crankcase breather tube .....	Every 600 hours
Check transmission-hydraulic oil level .....	Every 50 hours
Change transmission-hydraulic oil .....	Every 200 hours
Clean transmission-hydraulic oil screen	
850 and 950 without hydraulic filter .....	Every 200 hours
850, 950 and 1050 with hydraulic filter .....	After first 100 hours then Every 600 hours
Replace transmission-hydraulic oil screen	
850 and 950 without hydraulic filter .....	Every 600 hours
850, 950 and 1050 with hydraulic filter .....	Every 1200 hours
1050 (all) .....	Every 1200 hours

## Tune-Up

ITEM	SPECIFICATION
PTO Horsepower	
850 and 900HC .....	16.4 kW (22 hp)
950 .....	20.1 kW (27 hp)
1050 .....	24.6 kW (33 hp)
Compression .....	3916-4405 kPa (39.1-44.0 bar) (568 to 639 psi)
Thermostat opening temperature .....	71°C (160°F)
Radiator cap pressure release .....	98 kPa (1.0 bar) (14 psi)
Engine speeds	
850 and 900HC	
Slow idle .....	800 rpm
Fast idle .....	2700 rpm
Rated speed at full load .....	2600 rpm
950	
Slow idle .....	800 rpm
Fast idle .....	2600 rpm
Rated speed at full load .....	2400 rpm
1050	
Slow idle .....	800 rpm
Fast idle .....	2575 rpm
Rated speed at full load .....	2400 rpm

## Lubrication

Engine crankcase oil capacity	
850 and 900HC .....	4.5 L (5 U.S. quarts)
950 .....	6.4 L (7 U.S. quarts)
1050 .....	6.4 L (7 U.S. quarts)
Transmission-hydraulic system capacity	
850 ( -16000) and 950 ( -20000) .....	18 L (19 U.S. quarts)
850 (16001- ), 950 (20001- ), and 1050 .....	27 L (28.5 U.S. quarts)
900HC .....	28 L (29.6 U.S. quarts)
MFWD axle housing capacity	
850 .....	6.5 L (6.9 U.S. quarts)
950 and 1050 .....	8.5 L (8.9 U.S. quarts)
Service intervals	
Check engine oil level .....	Every 10 hours
Change engine oil .....	After first 50 hours then Every 100 hours
Replace engine oil filter .....	After 50 hours then Every 200 hours
Clean crankcase breather tube .....	Every 500 hours
Check transmission-hydraulic oil level .....	Every 50 hours
Change transmission-hydraulic oil .....	After 100 hours then Every 200 hours
Clean transmission-hydraulic oil screen	
850, 900HC and 950 without hydraulic filter .....	Every 200 hours
850, 900HC, 950 and 1050 with hydraulic filter .....	After first 100 hours then Every 500 hours
Replace transmission-hydraulic oil screen	
850, 900HC and 950 without hydraulic filter .....	Every 500 hours
850, 900HC and 950 with hydraulic filter .....	Every 1000 hours
1050 (all) .....	Every 1000 hours

*\*Front wheel drive 950 and 1050 Tractors only.\**

**Lubrication—Continued**

Replace transmission-hydraulic oil filter	
850, 900HC and 950 (if equipped) . . . . .	After first 100 hours then Every 200 hours
1050 (all) . . . . .	After first 100 hours then Every 200 hours
Check lubricant level in front axle housing*	Every 50 hours
Change lubricant in front axle housing*	After first 100 hours then Every 600 hours
Clean and repack front wheel bearings . . . . .	Every 500 hours
Lubricate grease fittings	
Front axle pivot pin . . . . .	Every 10 hours
All others . . . . .	Every 50 hours

\*Front-wheel drive 950 and 1050 tractors only

**Separation**

ITEM	SPECIFICATIONS
Fan belt deflection (at 89 N [20 lbs.] push) . . . . .	10 to 15 mm (3/8 to 5/8 in.)
ROLL-GARD Cap Screws	
Top . . . . .	100 N·m (75 ft-lbs)
Lower . . . . .	245 N·m (180 ft-lbs)
Engine Fender-to-Axle housing . . . . .	90 N·m (65 ft-lbs)
Fender-to-step . . . . .	30 N·m (22 ft-lbs)
Step-to-transmission case . . . . .	50 N·m (36 ft-lbs)
Axle housing-to-transmission case . . . . .	50 N·m (36 ft-lbs)
Drag Link-to-Pitman Arm . . . . .	50 N·m (36 ft-lbs)
Clutch housing-to-transmission case	
850 and 950 without front wheel drive . . . . .	120 to 150 N·m (87 to 108 ft-lbs)
950 with front wheel drive and all 1050 . . . . .	170 to 200 N·m (123 to 145 ft-lbs)
Clutch housing-to-engine . . . . .	90 N·m (65 ft-lbs)
Side frames-to-engine . . . . .	90 N·m (65 ft-lbs)
Hydraulic lines-to-pump . . . . .	8 N·m (5.8 ft-lbs)
Hood mounting bracket cap screws . . . . .	50 N·m (36 ft-lbs)

**SERVICE EQUIPMENT AND TOOLS**

Name	Use
JDST-28 Belt Tension Tool	Check fan belt tension.
<i>Note: Order from your SERVICE-GARD™ Catalog.</i>	
Hand Tachometer	Check engine speed.
D-05104ST Radiator Tester	Pressure test cooling system and radiator caps.
AR62377 Dry Element Cleaning Gun	Clean air filter.
<i>Note: Order from Service Tools P.O. Box 314 Owatonna, MN 55060</i>	

Separation

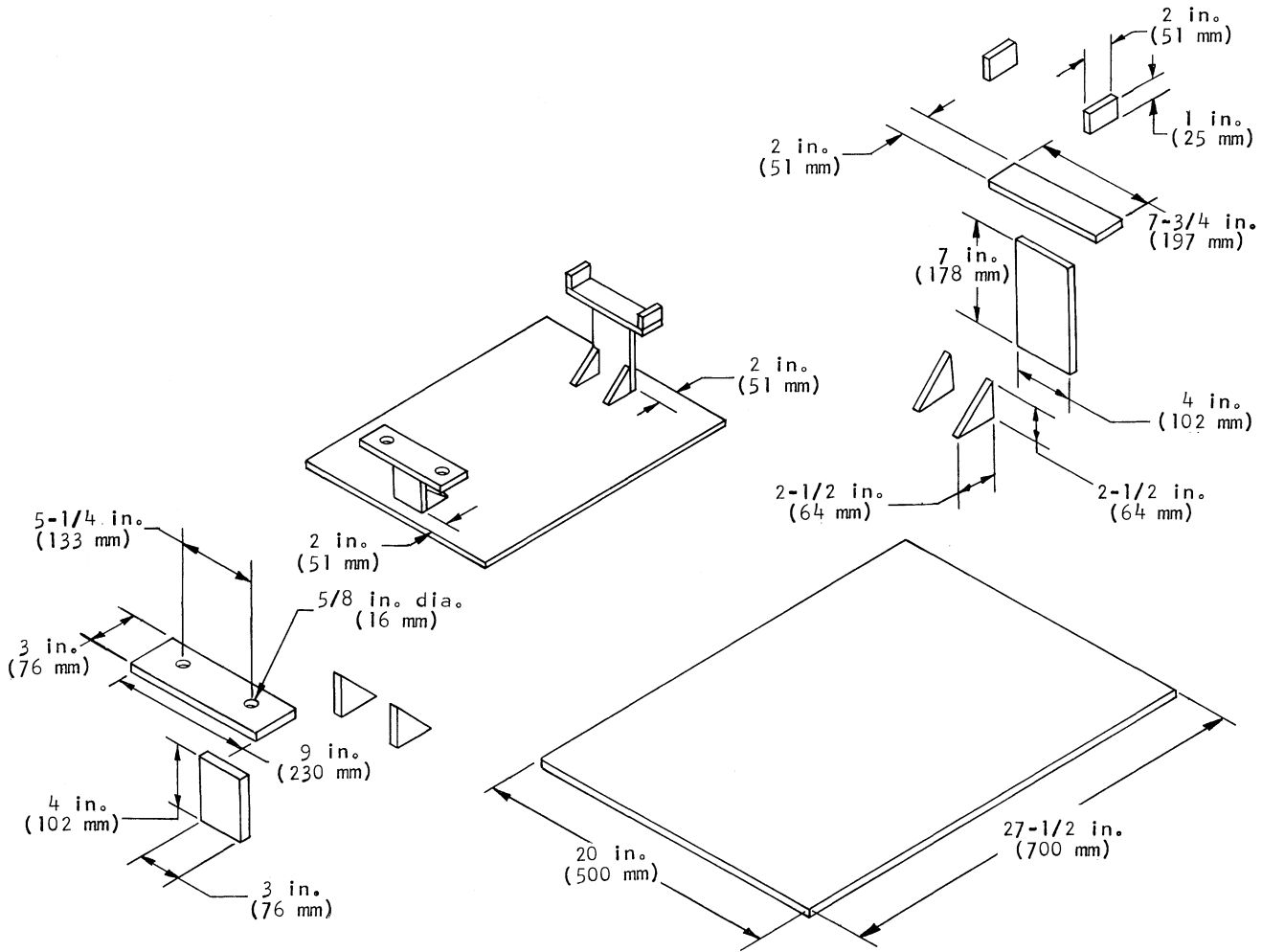

R 30803

Fig. 5-Transmission Stand

NOTE: Make from 5/16 in. steel and weld all joints.

## Group 05

# PREDELIVERY, DELIVERY, AND AFTER-SALE SERVICES 850 AND 950 TRACTORS

**IMPORTANT:** The 850 and 950 Tractors require set-up and assembly per instructions in shipping crates. Perform these operations prior to predelivery which follows.

The John Deere Delivery Receipt, when properly filled out and signed by the dealer and customer verifies that the predelivery and delivery services were satisfactorily performed. When delivering this machine give the customer his copy of the delivery receipt and the operator's manual. Explain their purpose to him.

Because of the shipping factors involved, plus extra finishing touches that are necessary to promote customer satisfaction, proper predelivery service is of prime importance to the dealer.

Instructions pointing out factory-recommended procedure for tractor setup and a tag pointing out factory-recommended procedure for predelivery are attached to the tractor.

After completing the factory-recommended dealer checks and services listed on the set up instructions and the predelivery tag, remove the tag and file it with the shop order for the job. The tag will certify that the tractor has received the proper predelivery service when that portion of the customer's John Deere Delivery Receipt is completed.

### BEFORE STARTING TRACTOR

Before starting tractor, make a few quick checks to be sure it is in good operating condition. Check for any missing parts or damage.

### Checking Engine Oil Level

Remove engine oil dipstick (Fig. 1) and wipe it off. Re-insert dipstick, but do not screw it down. Remove dipstick and check oil level. If necessary, add enough oil to bring oil level to top of cross hatch marks on dipstick. Use JOHN DEERE TORQUE-GARD SUPREME SAE 10W-20 or its equivalent.

*NOTE: Tractor should be on a level surface when oil level is checked. If it is not, check only to make sure the crankcase is not dry. Recheck oil level later, when tractor is on level ground.*

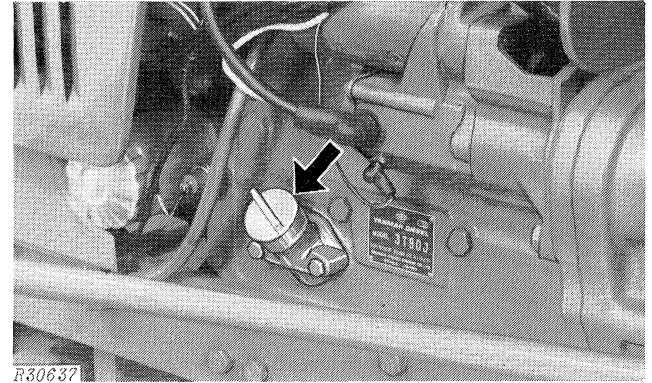
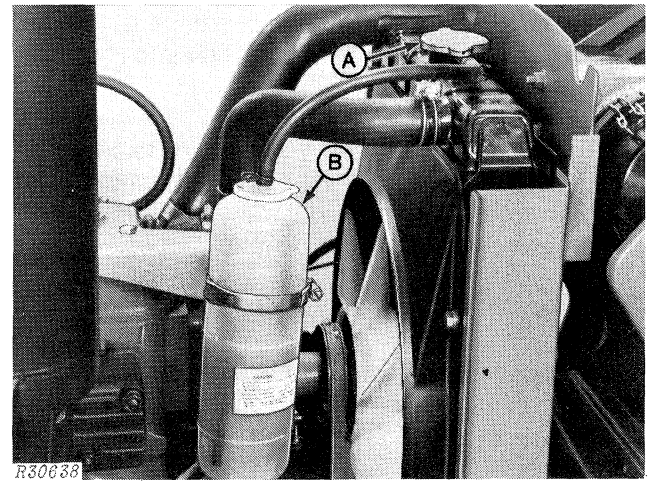

Fig. 1-Engine Oil Dipstick

### Checking Coolant Level



A—Radiator Cap

B—Expansion Tank

Fig. 2-Coolant Level Checks

Remove the radiator cap (A, Fig. 2) and check the radiator coolant level. The radiator should be full of coolant. The expansion tank (B) should have coolant up to the full mark on the expansion tank.

### Checking Transmission-Hydraulic System Oil Level

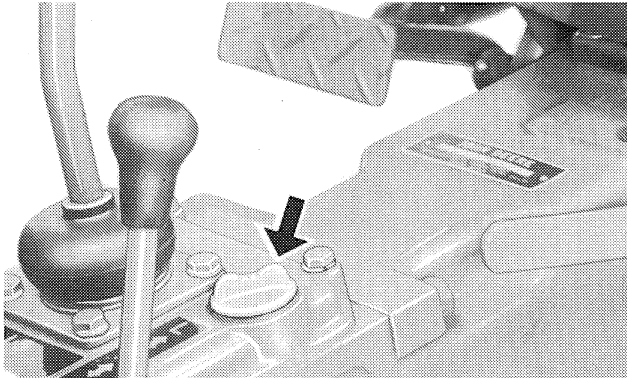

R30639

Fig. 3—Transmission-Hydraulic System Filler Cap

Remove transmission-hydraulic system filler cap (Fig. 3). Dipstick is attached to the filler cap. Re-insert dipstick, but do not screw it down. Remove dipstick and check oil level. If necessary, add enough oil to bring oil level to top of cross hatch marks on dipstick. Use JOHN DEERE HY-GARD Transmission and Hydraulic Oil or its equivalent.

*NOTE: Tractor should be on level surface when oil level is checked. If it is not, check only to make sure the system is not dry. Recheck oil level later when tractor is on level ground.*

### Tire Pressure

Check the inflation pressure to be sure it is within the pressures listed in the following chart.

TIRE SIZE	PLY RATING	INFLATION PRESSURE					
		MINIMUM†			MAXIMUM		
		kPa	(bar)	(psi)	kPa	(bar)	(psi)
<b>Front Tires</b>							
5.00-15	4	170	(1.7)	(24)	280	(2.8)	(40)
5.50-16**	4	170	(1.7)	(24)	280	(2.8)	(40)
7-14*	4	80	(0.8)	(12)	176	(1.8)	(26)
7-16**	4	140	(1.4)	(20)	220	(2.2)	(32)
25/8.50-14*	4	80	(0.8)	(12)	155	(1.6)	(23)
27/8.50-15**	4	70	(0.7)	(10)	100	(1.0)	(14)
<b>Rear Tires</b>							
11.2-24	4	80	(0.8)	(12)	120	(1.2)	(18)
12.4-28**	4	80	(0.8)	(12)	110	(1.1)	(16)
13.6-16*	4	80	(0.8)	(12)	100	(1.0)	(14)
13.6-28**	6	80	(0.8)	(12)	150	(1.5)	(22)
44/18.0-20**	4	80	(0.8)	(12)	100	(1.0)	(15)
*850 Tractor Only							
**950 Tractor Only							

### Checking Fuel Level

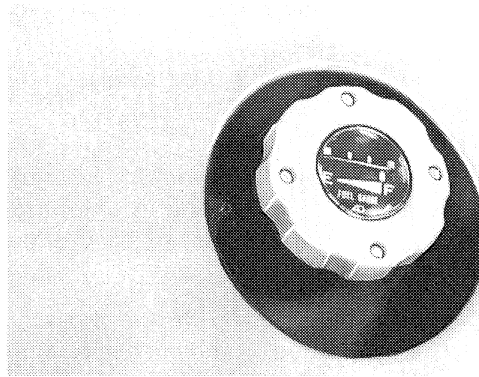

R30640

Fig. 4—Fuel Tank Filler Cap

Check fuel gauge to make sure tractor has enough fuel for driving around the lot. If not, add some. Do not run a diesel engine out of fuel.

### STARTING TRACTOR

If the previous checks have been made and everything is all right, the tractor is ready to be started.

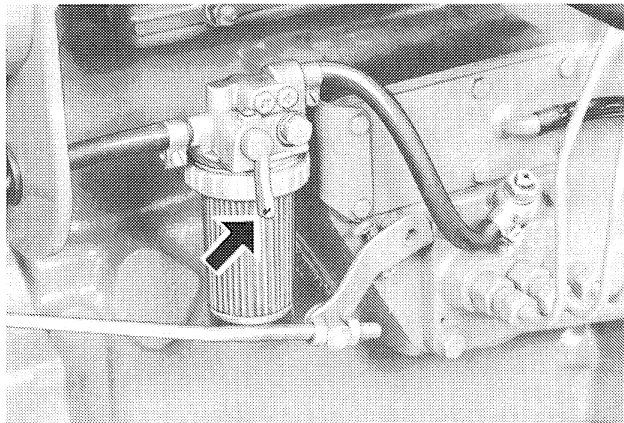

R30641

Fig. 5—Fuel Valve Handle

1. Open the fuel valve.
2. Put gear shift and PTO levers in neutral.
3. Push the throttle lever forward.



**Short-Term (Under 30 Days)—Continued**

Fig. 8-Clutch Fastened For Storage

4. Fasten clutch in a depressed position (Fig. 8) to prevent it from sticking.
5. Store tractor in a dry, protected place. If necessary to store tractor outside, cover it with a protective material. Protect tires from sunlight, heat and petroleum products.

**Long Term (Over 30 Days)**

1. If tractor is to be stored longer than 30 days, use an AR41785 Engine Storage Kit. Follow the instructions in the kit, except do not change engine oil, replace filters or drain and flush cooling system on a new tractor.
2. Loosen fan belt.
3. Fasten clutch in a depressed position (Fig. 8) to prevent it from sticking.
4. Clean the tractor. Touch up any painted surfaces which are scratched or chipped.
5. Coat exposed metal surfaces with grease or corrosion preventative.
6. Store tractor in a dry protective place. If necessary to store tractor outside, cover it with a protective material. Protect tires from heat, sunlight and petroleum products.
7. When removing tractor from storage, remove protective cover and unseal all openings. Check engine oil level, transmission-hydraulic system oil level, coolant level and tire inflation pressure. Install battery, adjust belt tension and fill fuel tank.

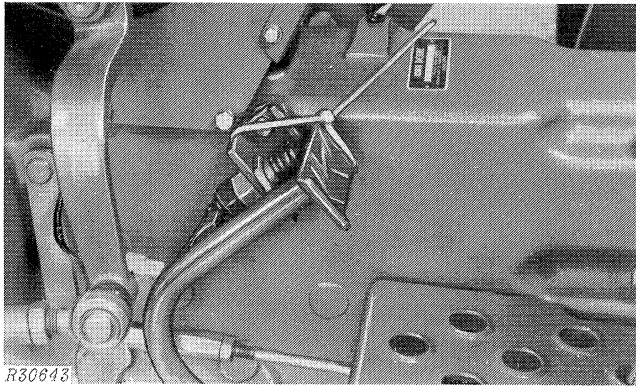
**PREDELIVERY SERVICE ELECTRICAL SYSTEM****Batteries**

1. Check battery terminals and battery cable ends. If they are corroded, clean and coat them with a mixture of petroleum jelly and baking soda.
2. Check electrolyte level in each battery cell. Add distilled water if necessary to bring level above cell plates.
3. If battery is not fully charged, charge it. Connect charger positive cable to the positive post on the battery and the ground cable to the negative post or the tractor frame.

**Belt Tension**

Fig. 9-Checking Fan Belt Tension

Check tension of fan belt and adjust if necessary. Fan belt should deflect 10 to 15 mm (3/8 to 5/8 inch) when a 89 N (20 lb.) force is applied.

**Lighting**

1. See that all lights work properly. With the light switch in "W" position, the warning lights should be on. In the "F" position the high beams and flood lamp should be on. In the "H<sub>1</sub>" position the high beams, tail light and warning lamps should be on. In "H<sub>2</sub>" position the low beams, tail light and warning lamps should be on.

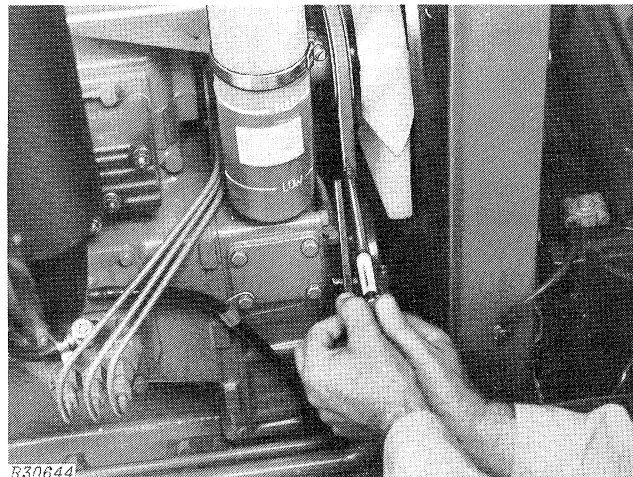
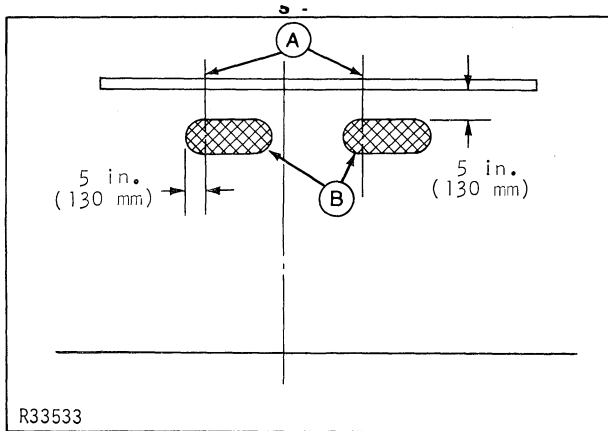

**A—Points Directly in Front of Lamps**  
**B—Small Zones of Bright Light**

*Fig. 10—Light Pattern at 25 ft. (8 m)*

1. Park tractor on level ground, 8 m (25 feet) from a wall.
2. Measure height of lamps above ground, and place a strip of masking tape on wall at same height.
3. Sight across steering wheel and hood ornament to locate tractor centerline. Mark this spot, and measure out 130 mm (5 inches) in each direction. This locates a spot directly in front of each lamp.
4. Turn light switch to H2, which switches head lamps to low beam.
5. Locate small zone of bright light projected by each lamp. Top of bright zone should be 130 mm (5 inches) lower than lamp, and left edge of zone should be 130 mm (5 inches) to left of lamp. Cover other lamp if necessary.
6. Adjust lamp assemblies if necessary. Adjusting screws are behind bulbs. Open hood for access.

## PREDELIVERY SERVICE COOLING SYSTEM

### Coolant Level

Remove radiator cap (A, Fig. 11) to see if the radiator is full of coolant. The expansion tank (B, Fig. 11) should have coolant up to the full mark.

If coolant level is low, fill to proper level and determine where coolant was lost.

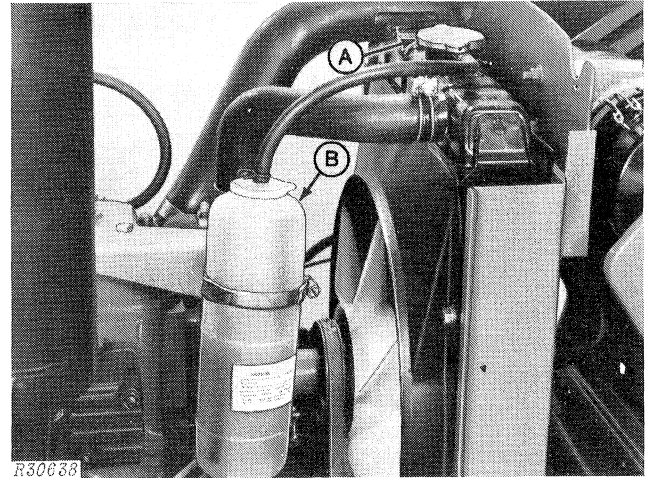

**A—Radiator Cap**

**B—Expansion Tank**

*Fig. 11—Coolant Level Checks*

### Anti-Freeze Protection

Use a dependable, temperature-correcting hydrometer to check anti-freeze protection of coolant. If more is needed, use permanent type, ethylene glycol anti-freeze which contains a rust inhibitor but does not contain a stop-leak additive.

### Leaks

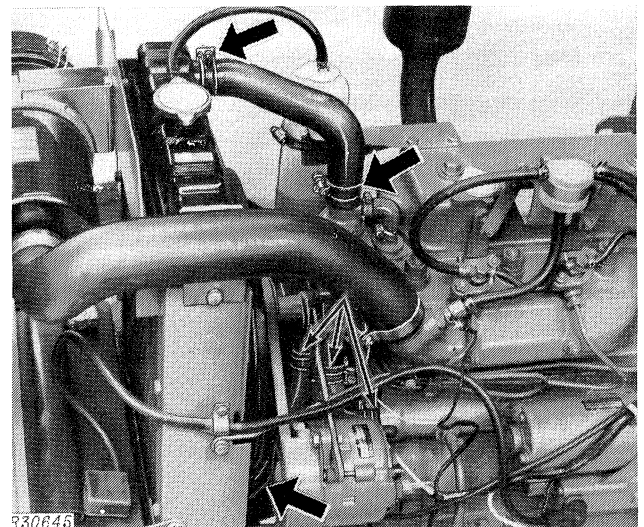
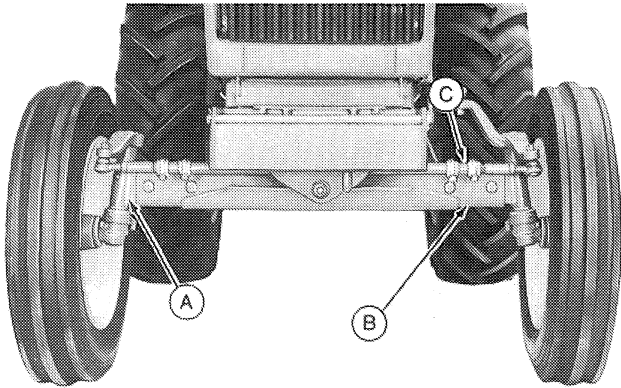

*Fig. 12—Cooling System Connections*

Check cooling system for any sign of leaks. Tighten clamps on radiator hoses.

## TIRES, WHEELS AND WEIGHTS

### Adjusting Front Tread Width



R30646

Fig. 13—Front Axle

Adjust front tread width to customer's needs.

1. Jack up front end of tractor.

*NOTE: Do not place jack under engine oil pan.*

2. Remove bolts from front axle (A, Fig. 13) and tie rods (C). Move the front axle knees (B) out to desired tread width.

3. Reinstall bolts. Tighten axle-to-knee bolts to 186 N·m (137 ft-lbs).

4. Adjust drag link so tractor will turn equally sharp in both directions. Chart below shows correct length of drag link for each tread width. Measure between centers of ball joints.

#### FRONT TREAD WIDTH      DRAG LINK LENGTH

##### 850 Tractor (2-Wheel Drive)

1115 mm (44 in.)	790 mm (31 in.)
1215 mm (48 in.)	793 mm (31-1/4 in.)
1315 mm (52 in.)	800 mm (31-1/2 in.)

##### 850 Tractor (MFWD)

1060 mm (42 in.)	800 mm (31-1/2 in.)
------------------	---------------------

##### 950 Tractor (2-Wheel Drive)

1160 mm (46 in.)	853 mm (33-1/2 in.)
1260 mm (50 in.)	859 mm (33-3/4 in.)
1360 mm (54 in.)	865 mm (34 in.)
1460 mm (58 in.)	875 mm (34-1/2 in.)

##### 950 Tractor (MFWD)

1250 mm (49 in.)	815 mm (32 in.)
------------------	-----------------

5. Check toe-in each time front tread is changed.

### Checking Toe-In

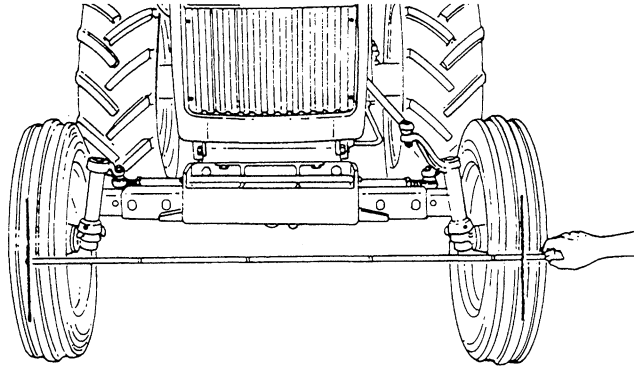

RW9654

Fig. 14—3 to 9 mm (1/8 to 3/8 in.) Toe-In

To check toe-in, steer the front wheels straight ahead and measure the distance from tire to tire, first in front and then at the rear. The front measurement should be 3 to 9 mm (1/8 to 3/8 inch) less than the rear.

If adjustment is needed, loosen lock nuts and turn tie rod tube until toe-in is correct. Tighten lock nuts.

Tie rods should be adjusted equal in length, so tractor will turn equally sharp in each direction.

### Adjusting Rear Tread Width

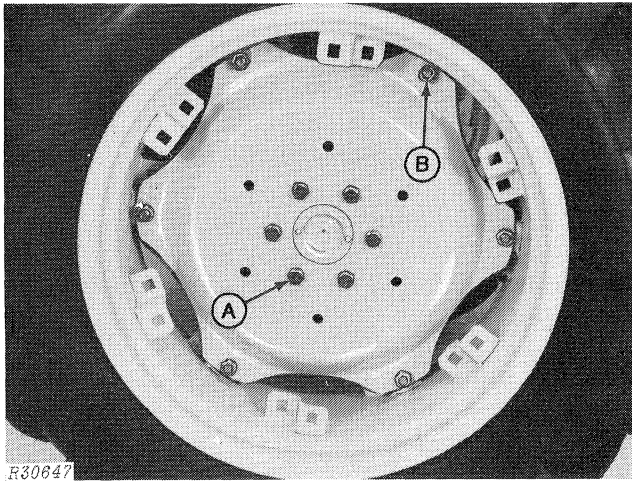

A—Wheel-To-Hub Bolts                      B—Wheel-To-Rim Bolts

Fig. 15-Rear Wheel Attaching Points

Adjust rear tread width to customer's needs.

1. Jack up tractor.
2. Remove six wheel-to-hub cap screws and remove wheel.

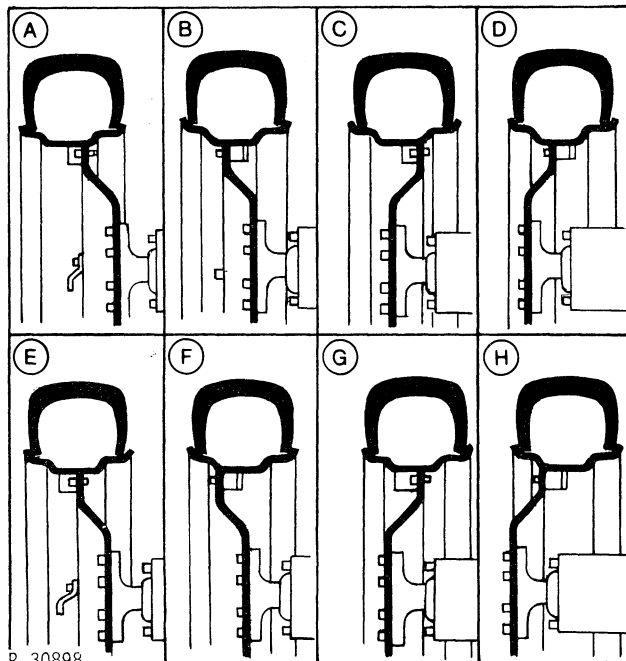

A—1.47 m (58 in.)	E—1.37 m (54 in.)
B—1.37 m (54 in.)	F—1.27 m (50 in.)
C—1.17 m (46 in.)	G—1.07 m (42 in.)
D—1.07 m (42 in.)	H—Do not use

Fig. 16-Rear Tread Widths For 850 and 950 Tractors With 11.2-24 Tires

3. Adjust by moving wheel in or out in the rim, or turn the wheel so it is dished in or out whichever is needed (Figs. 15 and 16).

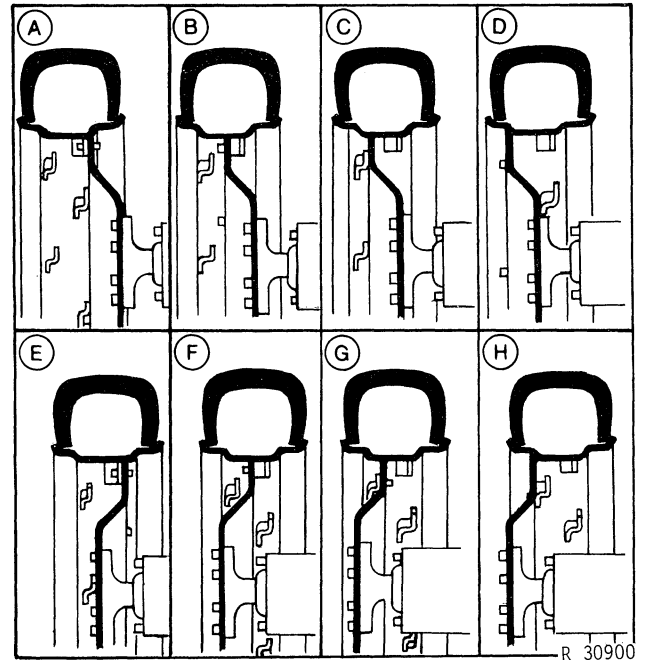

A—1.51 m (59 in.)	E—1.26 m (49 in.)
B—1.41 m (55 in.)	F—1.16 m (45 in.)
C—1.28 m (51 in.)	G—Do not use
D—1.19 m (47 in.)	H—Do not use

Fig. 17-Rear Tread Widths For 950 With 12.4-28 Tires

4. When the desired width is found, fasten wheel in rim and mount on tractor.

**IMPORTANT:** After driving, check torque of wheel-to-hub and wheel-to-rim cap screws.

### Installing Ballast Rear Wheel Weights

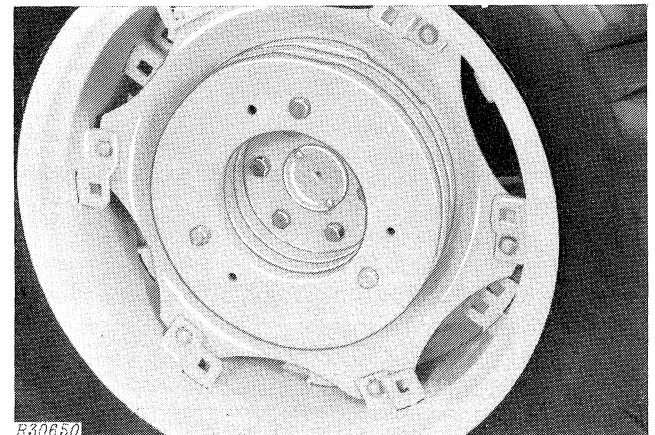
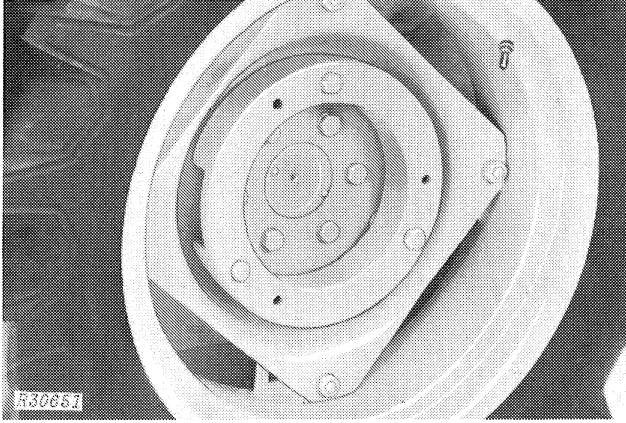

Fig. 18-Rear Wheel Weights Attached

### Rear Wheel Weights—Continued

To attach rear wheel weights, the first weight is bolted to the wheel and each succeeding weight is bolted to the previous one.



R30651

Fig. 19—Starter Weight Attached

When using 588 mm (24-inch) wheels with the wheel dished out, a starter weight has to be used next to the wheel before attaching other weights. The starter weight is thicker and smaller in diameter than a regular wheel weight.

### Front Weights

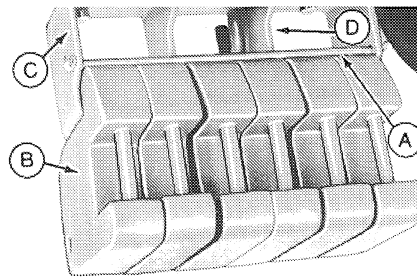

R30652

A—Retaining Rod                      C—Weight Support  
B—Quik-Tatch Weights              D—Center Brackets

Fig. 20—Quik-Tatch Front Weights

Up to six Quik-Tatch Front Weights may be installed on weight support. To Install:

1. Remove rod (A, Fig. 20).

2. Hang weights (B) on weight support (C).
3. Reinstall rod.

*NOTE: Weights are to be hung in pairs so they can't slide from side to side. Sliding is prevented by the center brackets (D, Fig. 20).*

### Liquid Ballast in Tires

Liquid ballast can be used in any tires; front or rear, tube or tubeless type.

Special equipment is required for installing fluid in tires. Follow instructions provided with the equipment, and observe the following restrictions.

1. Use calcium chloride to keep water from freezing. A mixture of 0.42 kg/L (3.5 lb/gal) of calcium chloride will not freeze solid above  $-45^{\circ}\text{C}$  ( $-50^{\circ}\text{F}$ ).
2. With the valve stem at the top of its revolution, fill tire only to the level of the valve stem. This leaves 25% air space to absorb impact.

### Checking Tire Inflation Pressure

Check inflation pressure of all tires. Inflate tires to the maximums on page 10-05-2. The customer can then easily reduce pressure slightly if necessary, depending on how tractor is used.

**LUBRICATION**

**Checking Engine Oil Level**

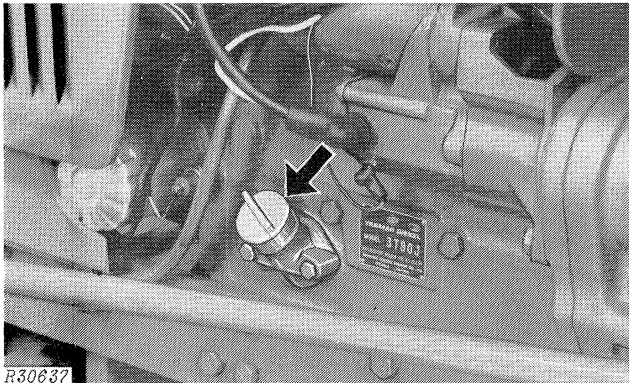

Fig. 21-Engine Oil Dipstick

Remove engine oil dipstick (Fig. 21) and wipe it off. Re-insert dipstick, but do not screw it down. Remove dipstick and check oil level. If necessary, add enough oil to bring oil level to top of cross hatch marks on dipstick. Use JOHN DEERE TORQUE-GARD SUPREME SAE 10W-20 or its equivalent.

**Checking Transmission-Hydraulic Oil Level**

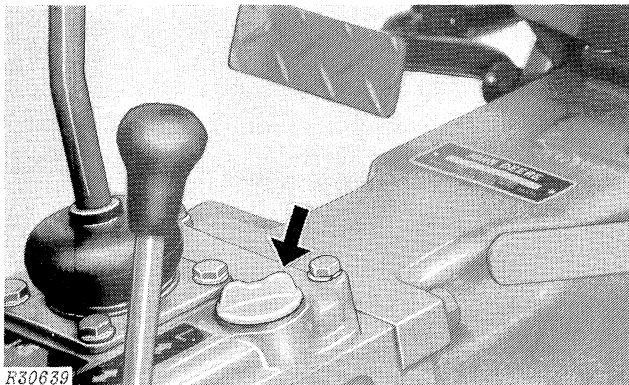

Fig. 22-Transmission-Hydraulic System Filler Cap

Remove transmission-hydraulic system filler cap (Fig. 22). Dipstick is attached to the filler cap. Re-insert dipstick, but do not screw it down. Remove dipstick and check oil level. If necessary, add enough oil to bring oil level to top of cross hatch marks on dipstick. Use JOHN DEERE HY-GARD Transmission and Hydraulic Oil or its equivalent.

**Lubricating Grease Fittings**

Lubricate all grease fittings. See instructions beginning on page 10-15-6.

**ENGINE**

**Checking Air Intake Connections**

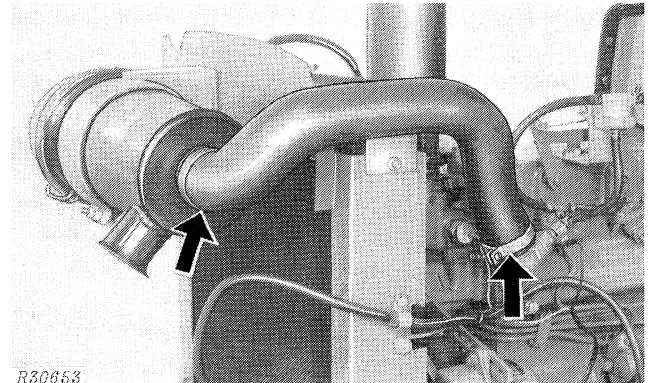

Fig. 23-Air Intake Connections

Check air intake connections for possible leaks. Tighten clamps if loose.

**Filling Fuel Tank**

Fill tank with fuel. Be sure fuel is clean. Fuel tank capacity is 32 L (8.5 gal.).

**Starting Engine**

1. Open fuel shut off valve.
2. Put gear shift and PTO levers in neutral.
3. Push the throttle lever forward.

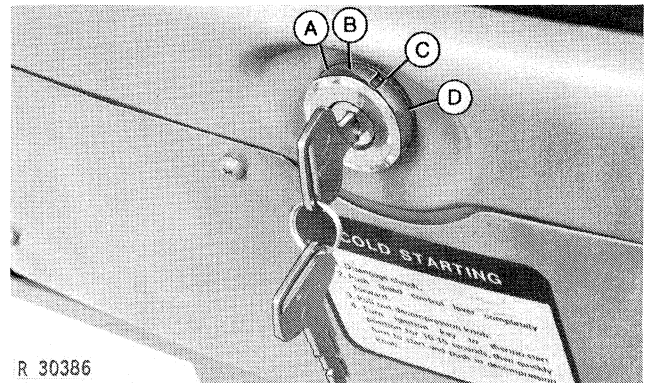

A—Thermo-Start  
B—Off

C—On  
D—Start

Fig. 24-Ignition Switch Positions

### Starting Engine—Continued

4. Insert key in the switch and turn clockwise to the first position (C, Fig. 24). The engine oil pressure and charge warning lamp should come on. If not, find out why and correct.

5. Depress clutch pedal and place range selector lever in neutral position.

6. Turn the key fully clockwise (D, Fig. 24) to start engine. Run engine at approximately 1500 rpm.

*NOTE: Early model \*850 and 950 tractors will not start unless clutch pedal is fully depressed. Late model \*\*tractors will not start unless range selector lever is in neutral position.*

**IMPORTANT: To prevent overheating of starter, do not operate it more than 20 seconds at a time. Wait at least two minutes between attempts.**

7. After engine starts, the oil pressure, charge and temperature\* warning lights should go off. If not, stop engine and determine the cause.

*NOTE: On early model \*tractors, only "OIL" and "CHG" lamps should glow when starter is engaged. On late model \*\*tractors, all indicator lamps should glow.*

8. Check brakes before moving tractor. Pedal travel should not exceed 20 to 35 mm (0.80 to 1.40 in.) on the 850 and 25 to 35 mm (1.00 to 1.40 in.) on the 950.

### Checking Engine Speeds

1. Remove PTO guard.
2. Engage PTO.
3. Start engine.
4. Pull throttle back to slow idle detent.

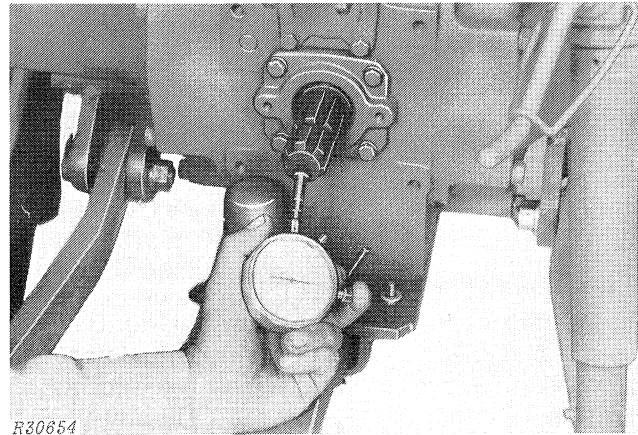

Fig. 26-Checking PTO Speed

5. Measure PTO speed using hand tachometer.
6. Refer to chart below to get engine speed. Slow idle speed for the 850 and 950 is 800 rpm.
7. Push throttle all the way forward and measure PTO speed.
8. Refer the chart below to get engine speed. Fast idle speed for the 850 is 2700 rpm and 2600 for the 950.

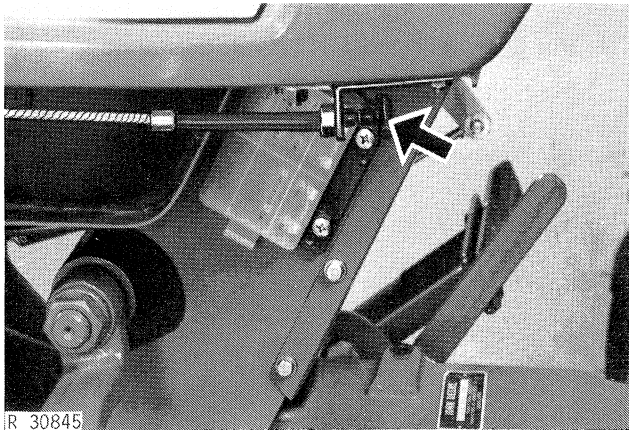

Fig. 25-Decompression Cable (Early Model \*Tractors Only)

*NOTE: On early model \*tractors in cold weather, turn the key counterclockwise (A, Fig. 24) to activate the thermostart. Hold for ten to fifteen seconds, pull the decompression cable (Fig. 25), then quickly turn fully clockwise (D) to start the engine. Push in decompression cable as soon as engine starts turning.*

- \*850 Tractor ( -009000)
- 950 Tractor ( -012000)
- \*\*850 Tractor (009001- )
- 950 Tractor (012001- )

#### ENGINE—PTO SPEED RELATIONSHIP

	850 TRACTOR		950 TRACTOR	
	Engine RPM	PTO RPM	Engine RPM	PTO RPM
Fast Idle	2700±25	648±6	2600±25	624±6
Slow Idle	800±25	192±6	800±25	192±6
Rated Speed	2600	624	2400	576
PTO Speed	2250	540	2250	540

9. If idle speeds are incorrect disconnect speed control linkage and test engine speeds as instructed in Group 10 of Section 230.

10. If idle speeds are correct with speed control linkage disconnected, check and adjust linkage as instructed in Group 15 of Section 230. If not, remove and test injection pump as instructed in Group 10 of Section 30.

### OPERATION

#### Driving Tests

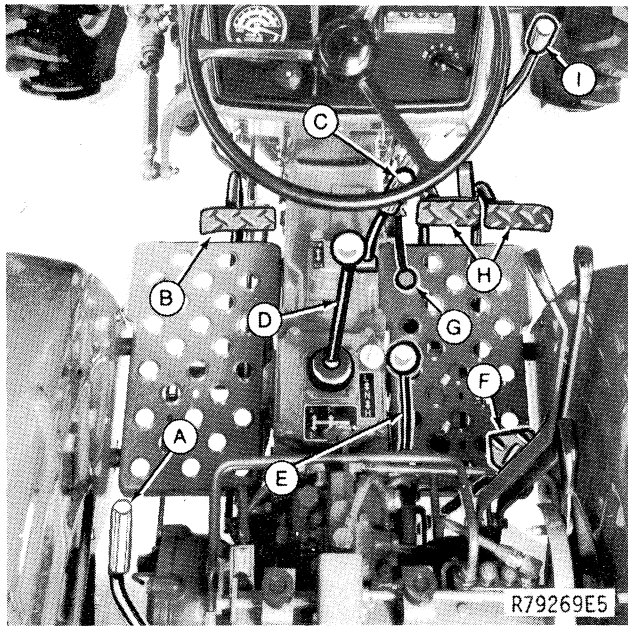

- |   |                        |
|---|------------------------|
| A—PTO Lever   | E—Range Selector Lever |
| B—Clutch Pedal                                      | F—Differential Lock    |
| C—Front Wheel Drive Shift Lever (Optional 950 Only) | G—Foot Throttle        |
| D—Gear Shift Lever                                  | H—Brake Pedals         |
|   | I—Hand Throttle        |

Fig. 27-Operator Controls

1. Shift transmission through all gears, driving tractor in each gear. If you find any problem in transmission, shift levers, clutch or any part of power train, refer to Section 250.

2. Check for smooth operation of all controls. If you find any problem, refer to the appropriate area in this manual.

*NOTE: On Front Wheel Drive 950 Tractors, depress clutch pedal and stop tractor to engage or disengage front wheel drive.*

3. Check operation of differential lock. While driving tractor, depress differential lock pedal. Differential lock should disengage whenever pedal is released.

If differential lock does not function properly, refer to Section 250.

#### Brakes

Be sure that brakes are properly adjusted and that both sides brake equally.

If any problem is found, refer to Group 10 of Section 260.

#### Power Take-Off

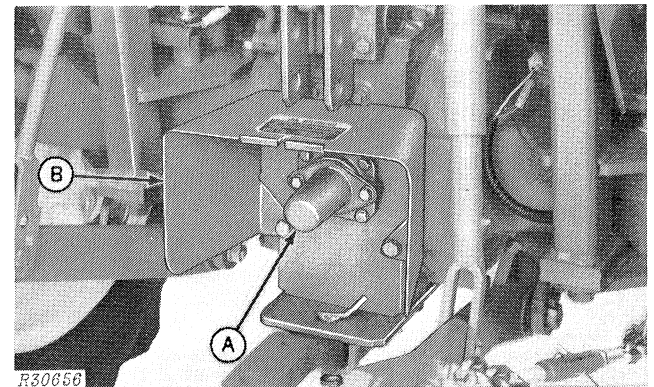

A—PTO Guard

B—Master Shield

Fig. 28-Power Take-Off

1. Examine PTO guard (A, Fig. 28) and master shield (B).

2. With PTO guard removed and engine running, make sure PTO shaft rotates when PTO lever is engaged and stops within a few seconds after PTO lever is disengaged.

3. If you find any problem, refer to Group 15 of Section 50.

**Implement Hitch Components**

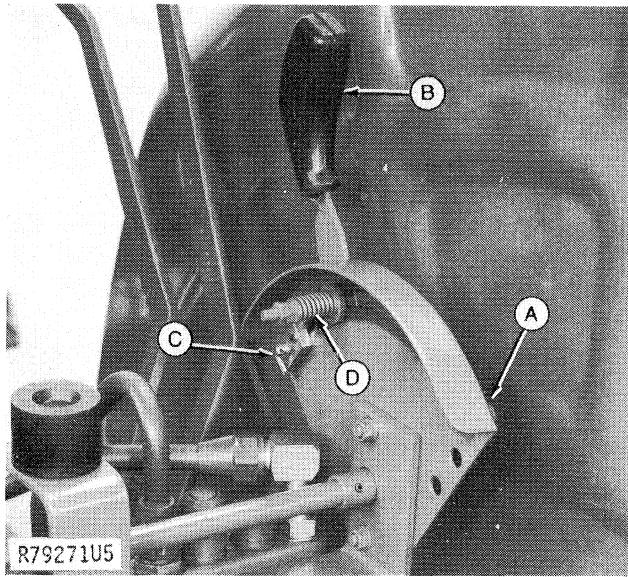

**A—Height Stop**                      **C—Depth Stop**  
**B—Control Lever**                    **D—Friction Adjusting Screw**

*Fig. 29-Rockshaft Control Lever*

1. Raise and lower rockshaft several times to make sure it functions smoothly. If control lever is too easy or too hard to move, reset friction adjusting screw.

2. Inspect all components of implement hitch area. Check for missing parts, damage, or anything which might lead to problem.

**General**

1. Tighten the following bolts to the torque specified.

Wheel to Hub

Front

- Two Wheel Drive ..... 133 N·m (98 ft-lb)
- Front Wheel Drive ..... 185 N·m (135 ft-lb)
- Rear ..... 133 N·m (98 ft-lb)

Wheel-to-Rim ..... 186 N·m (137 ft-lb)

Drag Link-to-Pitman

Arm ..... 92 N·m (65 ft-lb)

ROLL-GARD

- Upper ..... 100 N·m (74 ft-lb)
- Lower ..... 245 N·m (180 ft-lb)

2. Check all accessible nuts and cap screws. If you find any that are loose, tighten according to chart below.

3. Check engine, fuel system, cooling system, and hydraulic system for leaks. Correct as necessary.

4. Clean tractor and touch up paint.

**TORQUE CHART**

Bolt Diameter	Grade 4		Grade 7	
	N·m	ft-lbs	N·m	ft-lbs
6 mm	5-7	4-5	8-12	6-9
8 mm	13-17	9-12	23-30	17-22
10 mm	25-33	19-24	45-60	33-44
12 mm	45-60	33-44	80-100	59-73
14 mm	70-85	51-62	118-147	87-109
16 mm	110-140	83-103	170-210	125-155
18 mm	160-190	117-140	235-284	174-210
20 mm	216-265	159-195	324-402	239-297

## DELIVERY SERVICE

A thorough discussion of the operation and service of a new tractor at the time of delivery helps to assure complete customer satisfaction. Proper delivery should be an important phase of a dealer's program. A portion of the John Deere Delivery Receipt emphasizes the importance of proper delivery service.

Many complaints have arisen simply because the owner was not shown how to operate and service his new tractor properly. Enough time should be devoted, at the customer's convenience, to introducing the owner to his new tractor and explaining to him how to operate and service it.

The following procedure is recommended before the serviceman and owner complete the delivery acknowledgment portion of the delivery receipt.

Using the tractor operator's manual as a guide, be sure the owner understands these points thoroughly:

1. Controls and instruments.
2. How to start and stop the engine.
3. The importance of the break-in period.
4. How to use liquid or cast-iron ballast.
5. All functions of the hydraulic system.
6. Using the power takeoff.
7. The importance of safety.
8. The importance of lubrication and periodic services.

Give particular emphasis to rockshaft speed-of-drop, rockshaft selector lever and voltmeter (how to see whether alternator is charging). These areas are very often misunderstood.

After explaining and demonstrating the above features, have the owner sign the delivery receipt and give him the operator's manual.

## AFTER-SALE INSPECTION

The purchaser of a new John Deere tractor is entitled to a free inspection within the warranty period after the equipment has been "run in". The terms of this after-sale inspection are outlined on the back of the John Deere Delivery Receipt.

The purpose of this inspection is to make sure that the customer is receiving satisfactory performance from his tractor. At the same time, the inspection should reveal whether the tractor is being operated, lubricated, and serviced properly.

If the recommended after-sale service inspection is followed, the dealer can eliminate a needless volume of service work by preventing minor irregularities from developing into serious problems later on. This will promote strong dealer-customer relations and present the dealer an opportunity to answer questions that may have arisen during the first few days of operation.

The following inspection program is recommended within the first 100 hours of tractor operation.

### Cooling System

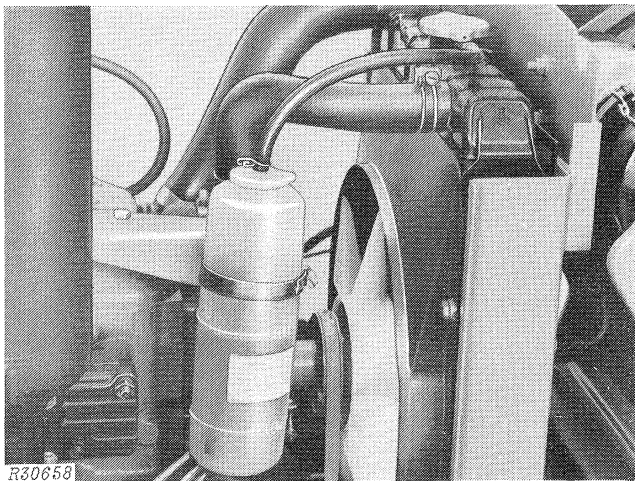

Fig. 30-Expansion Tank Coolant Level

1. Check radiator expansion tank. Coolant should be between the marks on the tank. If not, fill to the full mark and determine where the coolant was lost.

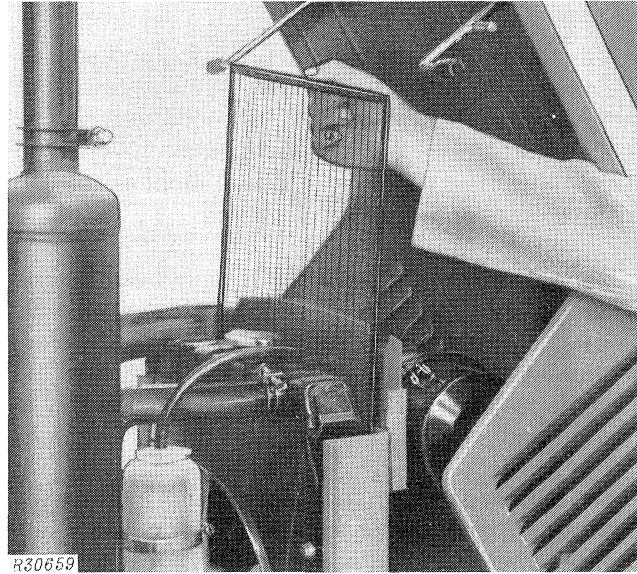

Fig. 31-Removing Radiator Screen

2. Remove any debris which has collected on the radiator screen.

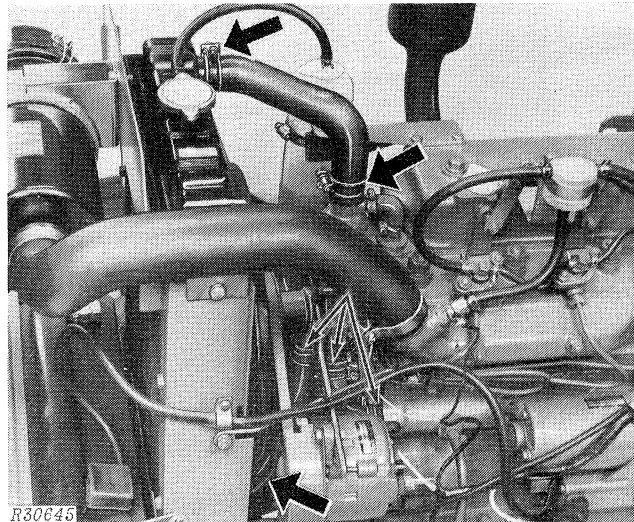
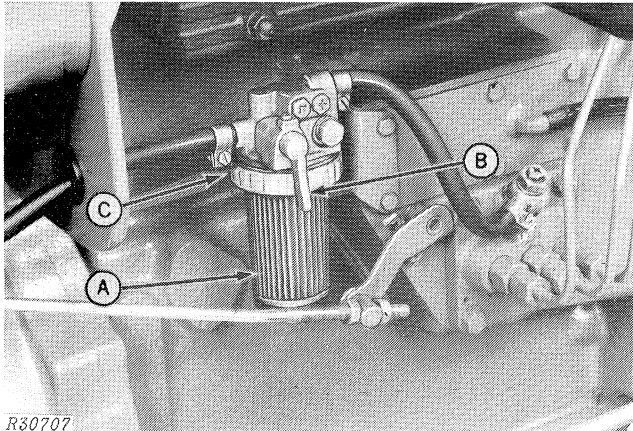

Fig. 32-Cooling System Connections

3. Check all hoses and connections for leaks. Correct if any are found.

## Fuel System



R30707

**A—Sediment Bowl    B—Valve Handle    C—Retaining Nut**

*Fig. 33-Fuel Filter Housing*

1. Check sediment bowl (A, Fig. 32) for dirt or water. Empty if necessary.

To empty, close the valve on the filter housing (B), then turn the retaining nut loose (C) and remove sediment bowl.

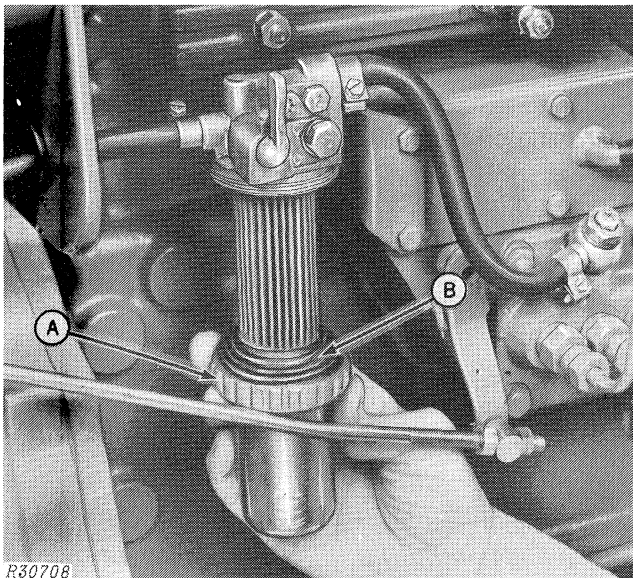

R30708

**A—Retaining Nut    B—O-Ring**

*Fig. 34-Reinstalling Sediment Bowl*

When reinstalling sediment bowl, be sure the O-ring (B, Fig. 34) is in the groove in the retaining nut (A). Also, open the valve to let fuel flow out. Doing this prevents air from getting in the system.

Remind customer of importance of proper fuel storage.

2. Check entire system for leaks.
3. Inspect air filter and clean if necessary.

## Lubrication

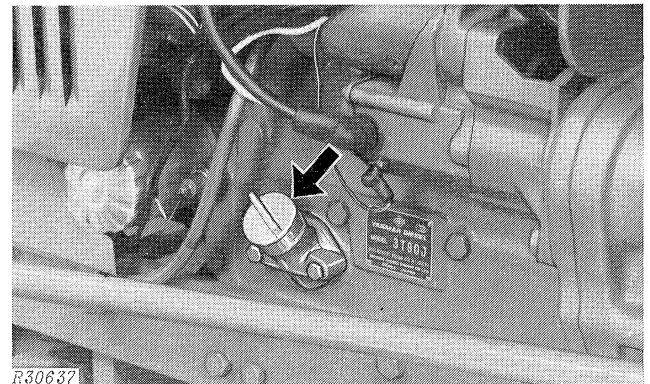

R30637

*Fig. 35-Engine Oil Dipstick*

1. With the tractor on level ground and stopped for ten minutes or more, loosen dipstick and remove it. If the oil level is low, add enough oil to bring it up to the top of cross-hatching.

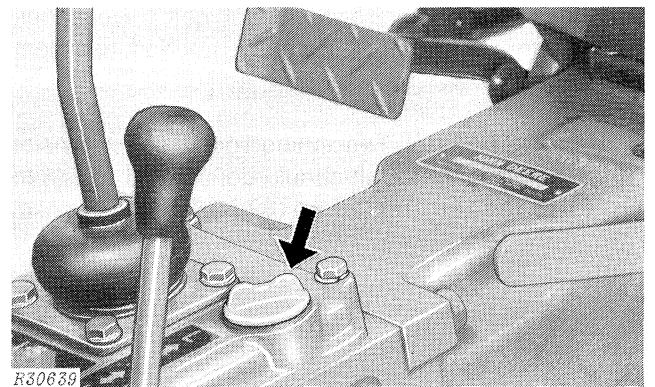

R30639

*Fig. 36-Transmission-Hydraulic System Dipstick*

2. With the tractor on level ground, loosen the transmission dipstick and see if the oil level is in the safe range. If not, add enough oil to bring it up to the top of cross-hatching.

## Electrical System

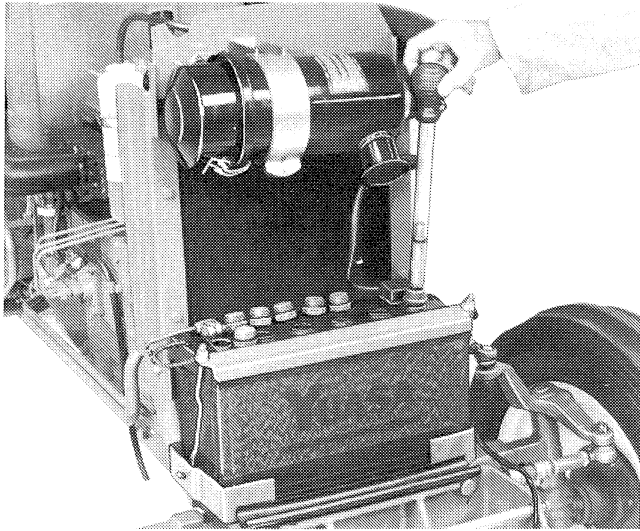

R30660

Fig. 37—Checking Specific Gravity

1. Check specific gravity of battery with a hydrometer. Specific gravity is 1.260 when corrected for 80°F (27°C). To correct for temperature of electrolyte, add 0.004 for every 10°F above 80°F (0.007 for every 10°C above 27°C). Subtract at the same if electrolyte is below 80°F (27°C).

If battery is not near full charge, determine the reason.

2. Check level of electrolyte in each cell. Level should be to bottom of filler neck. If water is needed, use clean mineral-free water.

3. Use JDST-28 Belt Tensioning Tool to check tension of fan belt (Fig. 38). Belt should deflect 3/8 to 5/8 in. (10 to 15 mm) when a 20 lb. (89 N) force is applied.

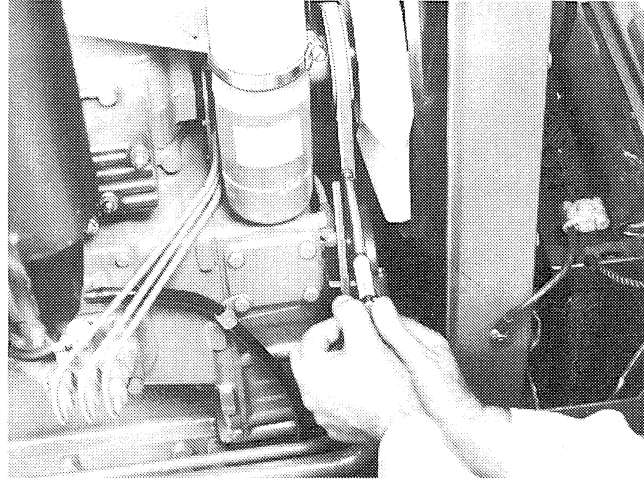

R30644

Fig. 38—Checking Belt Tension

4. Check operation of all lights. If there is a problem, refer to group 20 of Section 240.

5. Follow engine starting instructions beginning on 10-05-9. Check operation of starter and warning lights.

## OPERATION

Perform all checks as instructed under "OPERATION" beginning on page 10-05-11.

1. Driving tests.
2. Brake adjustment.
3. Power take-off.
4. Implement hitch components.

## ENGINE

1. Check engine speeds as instructed on page 10-05-10.

2. Check engine valve clearance as instructed in Group 10 of Section 20. Intake valve clearance should be 0.008 in. (0.20 mm). Exhaust valve clearance should be 0.006 in. (0.15 mm).

**General**

1. Tighten the following bolts to the torque specified.

Wheel to Hub

Front

- Two Wheel Drive ..... 133 N·m (98 ft-lb)
- Front Wheel Drive ..... 185 N·m (135 ft-lb)
- Rear ..... 133 N·m (98 ft-lb)

Wheel-to-Rim ..... 186 N·m (137 ft-lb)

Drag Link-to-Pitman

Arm ..... 92 N·m (65 ft-lb)

ROLL-GARD

- Upper ..... 100 N·m (74 ft-lb)
- Lower ..... 245 N·m (180 ft-lb)

2. Check all accessible nuts and cap screws. If you find any that are loose, tighten according to chart below.

3. Check engine, fuel system, cooling system, and hydraulic system for leaks. Correct as necessary.

**TORQUE CHART**

Bolt Diameter	Grade 4		Grade 7	
	N·m	ft-lbs	N·m	ft-lbs
6 mm	5-7	4-5	8-12	6-9
8 mm	13-17	9-12	23-30	17-22
10 mm	25-33	19-24	45-60	33-44
12 mm	45-60	33-44	80-100	59-73
14 mm	70-85	51-62	118-147	87-109
16 mm	110-140	83-103	170-210	125-155
18 mm	160-190	117-140	235-284	174-210
20 mm	216-265	159-195	324-402	239-297



## Group 06

# PREDELIVERY, DELIVERY, AND AFTER-SALE SERVICES 1050 TRACTORS

**IMPORTANT:** The 1050 Tractor requires set-up and assembly per instructions in shipping crates. Perform these operations before predelivery.

The John Deere Delivery Receipt, when properly filled out and signed by the dealer and customer, verifies that the predelivery and delivery services were satisfactorily performed. When delivering this machine, give the customer his copy of the delivery receipt and operator's manual. Explain their purpose to him.

Because of the shipping factors involved, plus extra finishing touches that are necessary for customer satisfaction, proper predelivery service is very important to the dealer.

Instructions pointing out factory-recommended procedure for tractor setup and a tag pointing out factory-recommended predelivery procedures are attached to the tractor.

After completing the factory-recommended dealer checks and services listed on the set up instructions and predelivery tag, remove and file the tag with the shop order for the job. The tag will certify that the tractor has received the proper predelivery service.

### BEFORE STARTING TRACTOR

Before starting tractor, check for missing parts or any damage and make sure it is in good operating condition.

#### Checking Engine Oil Level

*NOTE: Tractor should be level when oil level is checked. If it is not, check only to be sure system is not dry. Recheck oil level later when tractor is on level ground.*

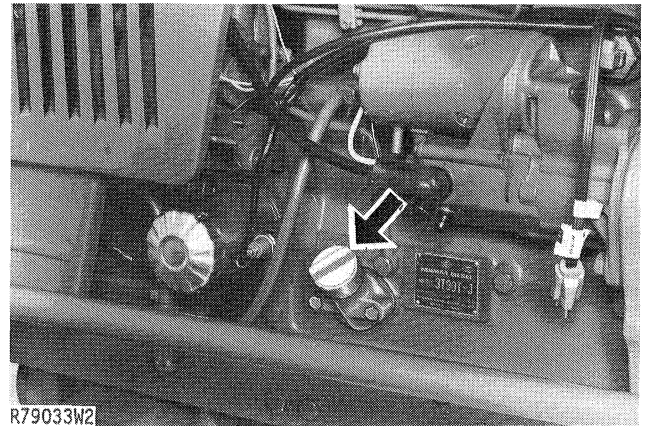
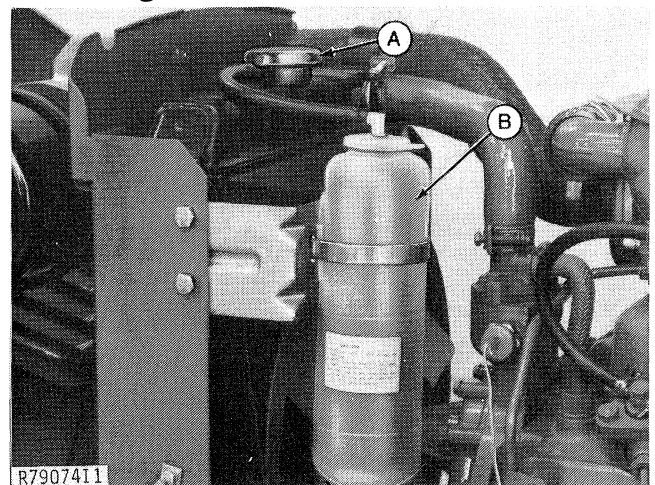

Fig. 1-Engine Oil Dipstick

Remove and wipe off engine oil dipstick (Fig. 1). Reinsert it only to where it rests on the threads—do not screw in. Observe oil level. If low, add enough oil to bring level to full mark. Use John Deere TORQ-GARD SUPREME SAE 10W-20 or its equivalent.

#### Checking Coolant Level



A—Radiator Cap

B—Expansion Tank

Fig. 2-Coolant Level Checks

Remove the radiator cap (A, Fig. 2) and check the coolant level. The radiator level should be full and the expansion tank (B) level should be on the full mark.



**Suggest:**

**If the above button click is invalid.**

**Please download this document**

**first, and then click the above link**

**to download the complete manual.**

**Thank you so much for reading**

## Checking Transmission-Hydraulic System Oil Level

**NOTE:** Tractor should be level when oil level is checked. If it is not, check only to see that system is not dry. Recheck level later when tractor is on level ground.

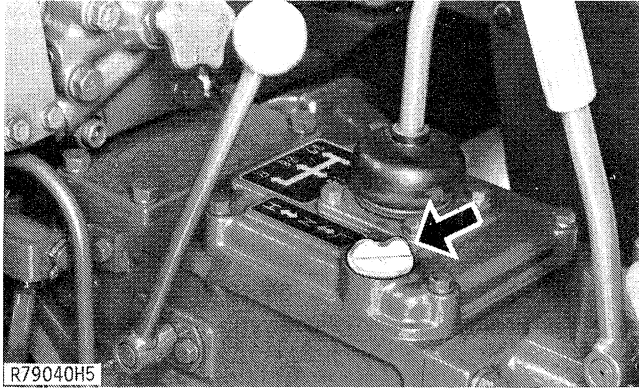

Fig. 3-Transmission/Hydraulic System Filler Cap

Remove cap and wipe off transmission/hydraulic system dipstick (Fig. 3). Reinsert only to where it rests on threads - do not screw in. If necessary, add enough oil to bring level to full mark. Use John Deere HY-GARD Transmission and Hydraulic Oil or its equivalent.

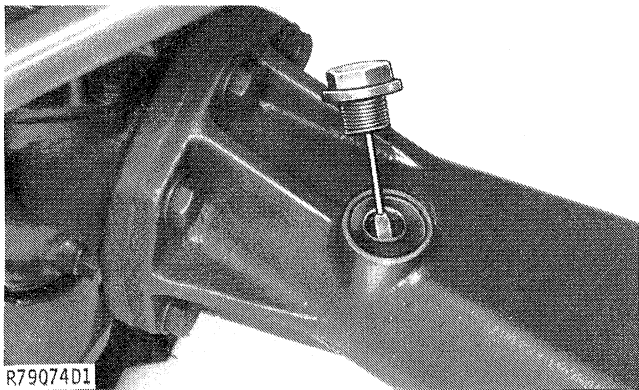
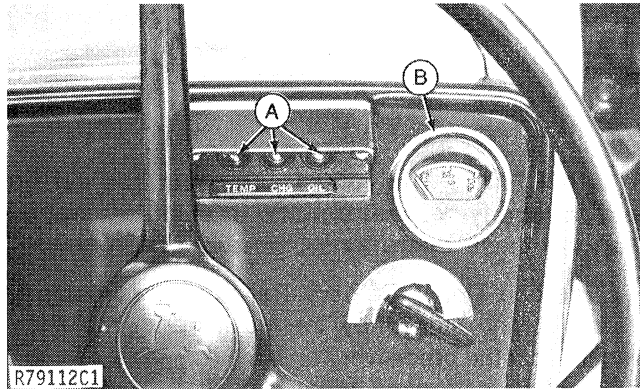

Fig. 4-Front Axle Dipstick

On Front-Wheel Drive tractors, check oil level in front axle housing. Remove and wipe off dipstick (Fig. 4) and reinsert only to where it rests on threads - do not screw in. If low, add John Deere SAE 90 Gear Lubricant or its equivalent.

**NOTE:** For information on complete draining and filling of system, refer to page 10-15-5.

## Checking Instrument Lamps And Fuel Level



A—Warning Lamps

B—Fuel Gauge

Fig. 5-Instrument Panel

1. Place range selector lever in "Low" position.

**CAUTION:** Depress clutch pedal from operators seat only; NOT standing on the ground.

2. Depress clutch pedal fully.

3. Turn key switch fully clockwise. Be sure that "OIL", "CHG", and "TEMP" lamps (A, Fig. 5) glow. If not, determine cause and repair. See Section 40, Group 20.

4. Observe fuel gauge (B). Be sure there is enough fuel for driving around the lot. Never run a diesel engine out of fuel.

## Tire Pressure

Check tire inflation pressure to be sure it is within the specifications listed in the chart on the following page.

**IMPORTANT:** Be sure tires rotate in proper direction. Arrows on sidewall should point in direction of forward rotation. Correct as necessary.

**<https://www.ebooklibonline.com>**

Hello dear friend!

Thank you very much for reading.

Enter the link into your browser.

The full manual is available for immediate download.

**<https://www.ebooklibonline.com>**