

655, 755, 855, 955, 756 and 856 Compact Utility Tractors

TECHNICAL MANUAL

**John Deere
Lawn & Grounds Care Division
TM1360 (June 1996)**

Introduction

FOREWORD

This manual is written for an experienced technician. Essential tools required in performing certain service work are identified in this manual and are recommended for use.

LIVE WITH SAFETY: Read the safety messages in the introduction of this manual and the cautions presented throughout the text of the manual.

PThis is the safety-alert symbol. When you see this symbol on the machine or in this manual, be alert to the potential for personal injury.

Technical manuals are divided in two parts: repair and diagnostics. Repair sections tell how to repair the components. Diagnostic sections help you identify the majority of routine failures quickly.

Information is organized in groups for the various components requiring service instruction. At the beginning of each group are summary listings of all applicable essential tools, service equipment and tools, other materials needed to do the job, service parts kits, specifications, wear tolerances, and torque values.

Binders, binder labels, and tab sets can be ordered by John Deere dealers direct from the John Deere Distribution Service Center.

This manual is part of a total product support program.

FOS MANUALS—REFERENCE

TECHNICAL MANUALS—MACHINE SERVICE

COMPONENT MANUALS—COMPONENT SERVICE

Fundamentals of Service (FOS) Manuals cover basic theory of operation, fundamentals of troubleshooting, general maintenance, and basic type of failures and their causes. FOS Manuals are for training new personnel and for reference by experienced technicians.

Technical Manuals are concise guides for specific machines. Technical manuals are on-the-job guides containing only the vital information needed for diagnosis, analysis, testing, and repair.

Component Technical Manuals are concise service guides for specific components. Component technical manuals are written as stand-alone manuals covering multiple machine applications.

NOTE: The 756 and 856 tractors are identical to the 755 and 855 tractors; therefore, all information pertaining to the 755 also pertains to the 756 and the same is true for the 855 and the 856 tractors. The 655, 756 and 856 tractors were all discontinued before the late model 755 and 855 tractors and the new 955 tractors were produced. Therefore, any late model references do not include the 655, 756, and 856 tractors.

Contents

SECTION 10—GENERAL INFORMATION

- Group 05—Safety
- Group 10—Repair Specifications
- Group 15—Repair Information
- Group 20—Fuels, Lubricants, and Coolants
- Group 25—Serial Number Locations

SECTION 20—DIESEL ENGINE REPAIR

- Group 05—Yanmar Diesel Engine Repair
- Group 10—Remove and Install Oil Cooler
- Group 15—Remove and Install Radiator
- Group 20—Remove and Install Diesel Engine

SECTION 30—FUEL AND AIR REPAIR

- Group 05—Fuel Transfer Pump
- Group 10—Fuel Tank
- Group 15—Fuel Tank Tube and Sender
- Group 20—Air Cleaner

SECTION 40—ALTERNATOR REPAIR

- Group 05—Alternator Repair Specifications
- Group 10—Alternator Installation

SECTION 50—POWER TRAIN REPAIR

- Group 05—Hydrostatic Transmission
- Group 10—Transaxle
- Group 15—Final Drives
- Group 20—Mechanical Front Wheel Drive (MFWD)
- Group 25—Power Train Gears and Shafts
- Group 30—Speed Control Linkage

SECTION 60—STEERING AND BRAKES REPAIR

- Group 05—Standard Front Axle
- Group 10—Steering Valve
- Group 15—Brake Linkage

SECTION 70—HYDRAULICS REPAIR

- Group 05—Hydraulic Pump
- Group 10—Flow Divider and Selective Control Valves (SCV's)
- Group 15—Rockshaft
- Group 20—Hydraulic Hoses

SECTION 80—MISCELLANEOUS REPAIR

- Group 15—Operator's Seat
- Group 20—European Roll-Gard®
- Group 25—German Rear Hitch
- Group 30—3-Point Hitch

SECTION 210—MACHINE OPERATIONAL CHECKOUT PROCEDURE

- Group 05—Machine Operational Checkout Procedure

SECTION 220—ENGINE/FUEL OPERATION AND TESTS

- Group 05—Engine Systems Operational Checkout Procedure
- Group 10—Engine System Diagnosis

SECTION 240—ELECTRICAL OPERATION AND TESTS

- Group 05—Electrical System Checkout
- Group 10—Electrical System Diagnosis
- Group 15—Theory of Operation

SECTION 250—POWER TRAIN OPERATION AND TESTS

- Group 05—Power Train System Checkout
- Group 10—Power Train Tests and Adjustments
- Group 15—Theory of Operation

SECTION 260—STEERING AND BRAKE OPERATION AND TESTS

- Group 05—Steering and Brakes System Checkout
- Group 10—Steering and Brakes Tests and Adjustments
- Group 15—Theory of Operation

SECTION 270—HYDRAULIC OPERATION AND TESTS

- Group 05—Hydraulic System Checkout
- Group 10—Hydraulic System Tests and Adjustments
- Group 15—Theory of Operation

INDEX

All information, illustrations and specifications in this manual are based on the latest information available at the time of publication. The right is reserved to make changes at any time without notice.

TM 1360-19-01Jun 96

COPYRIGHT©1996
DEERE & COMPANY
Moline, Illinois
All rights reserved
A John Deere ILLUSTRATION Manual
Previous Editions
Copyright© 1991, 1990, 1986 Deere & Company

10

20

30

40

50

60

70

80

210

220

<https://www.ebooklibonline.com>

Hello dear friend!

Thank you very much for reading.

Enter the link into your browser.

The full manual is available for immediate download.

<https://www.ebooklibonline.com>

Section 10

General Information

Contents

	Page		Page
Group 05—Safety		Group 25—Serial Number Locations	
Safety Items	10-05-1	Product Serial Number	10-25-1
Group 10—Repair Specifications		Engine Serial Number	10-25-1
General Tractor Specifications	10-10-1	Transaxle Serial Number	10-25-1
Group 15—Repair Information		Mower Deck Serial Number	10-25-1
Metric Fastener Torque Values	10-15-1		
Inch Fastener Torque Values	10-15-2		
O-Ring Face Seal Fittings	10-15-3		
O-Ring Boss Fittings	10-15-4		
Group 20—Fuels, Lubricants, and Coolants			
Diesel Fuel—North America	10-20-1		
Diesel Fuel Lubricity—North America	10-20-1		
Diesel Fuel Storage—North America	10-20-1		
Diesel Fuel—Europe	10-20-2		
Diesel Fuel Lubricity—Europe	10-20-2		
Diesel Fuel Storage—Europe	10-20-2		
Engine Oil—North America	10-20-3		
Engine Oil—Europe	10-20-4		
Break-in Engine Oil—North America	10-20-5		
Break-in Engine Oil—Europe	10-20-6		
Hydrostatic Transmission and Hydraulic Oil— North America	10-20-7		
Hydrostatic Transmission and Hydraulic Oil— Europe	10-20-8		
Gear Case Oil (MFWD)—North America	10-20-9		
Gear Case Oil (MFWD)—Europe	10-20-10		
Grease—North America	10-20-11		
Grease—Europe	10-20-12		
North America			
Alternative Lubricants	10-20-13		
Synthetic Lubricants	10-20-13		
Lubricant Storage	10-20-13		
Mixing of Lubricants	10-20-13		
Oil Filters	10-20-13		
Europe			
Alternative Lubricants	10-20-14		
Synthetic Lubricants	10-20-14		
Lubricant Storage	10-20-14		
Mixing of Lubricants	10-20-14		
Oil Filters	10-20-14		
Diesel Engine Coolant—North America	10-20-15		
Diesel Engine Coolant—Europe	10-20-16		

HANDLE FLUIDS SAFELY—AVOID FIRES

When you work around fuel, do not smoke or work near heaters or other fire hazards.

Store flammable fluids away from fire hazards. Do not incinerate or puncture pressurized containers.

Make sure machine is clean of trash, grease, and debris.

Do not store oily rags; they can ignite and burn spontaneously.



DX,FLAME -19-04JUN90

10
05
-UN-23AUG88
TS227

PREVENT BATTERY EXPLOSIONS

Keep sparks, lighted matches, and open flame away from the top of battery. Battery gas can explode.

Never check battery charge by placing a metal object across the posts. Use a volt-meter or hydrometer.

Do not charge a frozen battery; it may explode. Warm battery to 16°C (60°F).



DX,SPARKS -19-04JUN90

-UN-23AUG88
TS204

PREPARE FOR EMERGENCIES

Be prepared if a fire starts.

Keep a first aid kit and fire extinguisher handy.

Keep emergency numbers for doctors, ambulance service, hospital, and fire department near your telephone.

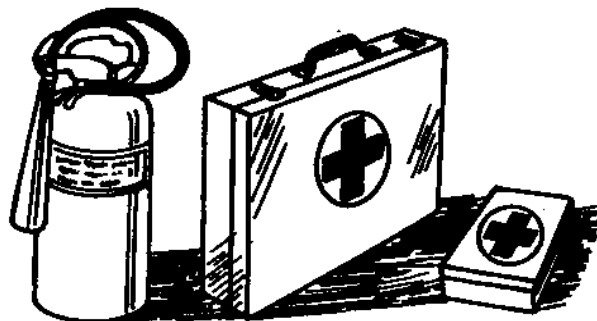

DX,FIRE2 -19-04JUN90

-UN-23AUG88
TS291

PREVENT ACID BURNS

Sulfuric acid in battery electrolyte is poisonous. It is strong enough to burn skin, eat holes in clothing, and cause blindness if splashed into eyes.

Avoid the hazard by:

1. Filling batteries in a well-ventilated area.
2. Wearing eye protection and rubber gloves.
3. Avoiding breathing fumes when electrolyte is added.
4. Avoiding spilling or dripping electrolyte.
5. Use proper jump start procedure.

If you spill acid on yourself:

1. Flush your skin with water.
2. Apply baking soda or lime to help neutralize the acid.
3. Flush your eyes with water for 10—15 minutes. Get medical attention immediately.

If acid is swallowed:

1. Drink large amounts of water or milk.
2. Then drink milk of magnesia, beaten eggs, or vegetable oil.
3. Get medical attention immediately.



DX, POISON -19-04JUN90

TS203 -UN-23AUG88

AVOID HIGH-PRESSURE FLUIDS

Escaping fluid under pressure can penetrate the skin causing serious injury.

Avoid the hazard by relieving pressure before disconnecting hydraulic or other lines. Tighten all connections before applying pressure.

Search for leaks with a piece of cardboard. Protect hands and body from high pressure fluids.

If an accident occurs, see a doctor immediately. Any fluid injected into the skin must be surgically removed within a few hours or gangrene may result. Doctors unfamiliar with this type of injury should reference a knowledgeable medical source. Such information is available from Deere & Company Medical Department in Moline, Illinois, U.S.A.

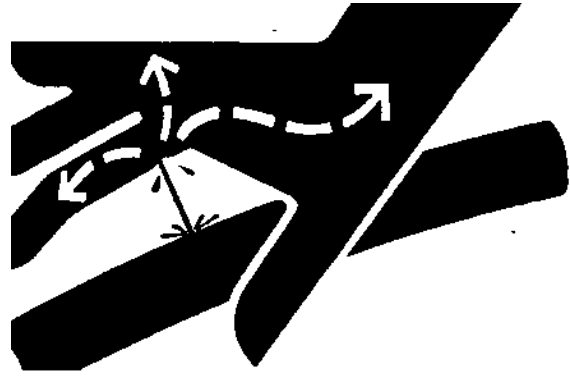

DX,FLUID -19-09AUG91

10
3
9
5
1
-UN-23AUG88
X9811

PARK MACHINE SAFELY

Before working on the machine:

- Lower all equipment to the ground.
- Stop the engine and remove the key.
- Disconnect the battery ground strap.
- Hang a "DO NOT OPERATE" tag in operator station.

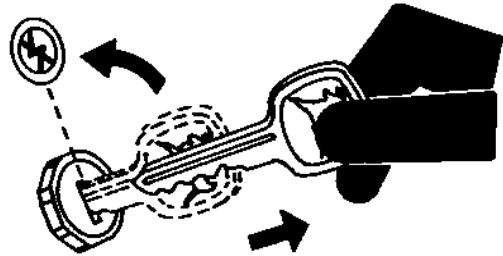

DX,PARK -19-04JUN90

-UN-24MAY69
TS230

SPECIFICATIONS

Item	Measurement	Specification
Charge Pump	Cap Screw Torque	37—50 N•m (27—37 lb-ft)
Charge Inlet Fitting	Torque	95—230 N•m (70—170 lb-ft)
Drive Shaft-to-Engine	Cap Screw Torque	49 N•m (35 lb-ft)
Drive Shaft-to-Hydro	Cap Screw Torque	60 N•m (45 lb-ft)
Neutral Return Lever Bushing	Inside Diameter	19.088 ± 0.025 mm (0.7515 ± 0.001 in)
Drive Shaft Coupler to Hydro Input Shaft	Torque	60 N•m (45 lb-ft)
Swash Plate End Caps	Cap Screw Torque	8—9 N•m (72—84 lb-in)
Transmission Center Section-to-Housing	Cap Screw Torque	44—55 N•m (33—41 lb-ft)
Gear-to-Output Shaft	Cap Screw Torque (Early Models) Castle Nut Torque (Late Models)	54 N•m (40 lb-ft) 109 N•m (80 lb-ft)
Transmission Attaching	Cap Screw Torque	142 N•m (105 lb-ft)
Neutral Return Lever Spring	Adjusted Coil Length	133 mm (5.25 in)
Plugs:		
3/4-16 SAE O-ring	Torque	45—95 N•m (33—70 lb-ft)
1/4-20 SAE O-ring	Torque	4—7 N•m (36—60 lb-in)

REMOVE AND INSTALL SHEET METAL PANELS

1. Park tractor safely. Lock park brake, remove key.
2. Turn depth control lever (A) clockwise until it stops.
3. Remove four cap screws. To remove panel (B), lift up on right rear corner of panel first, then lift left side to clear head of depth control bolt, and move panel out from the right side of the tractor.

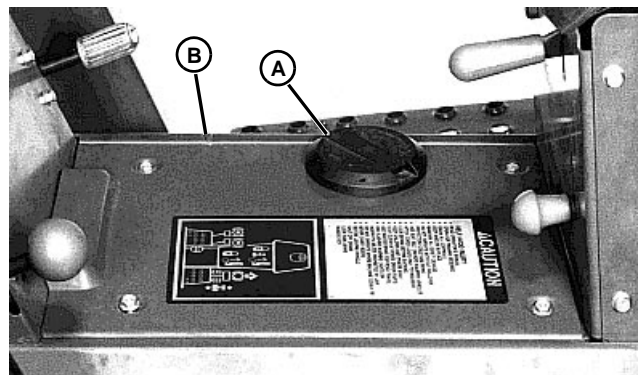

M43634

Hydrostatic Transmission/Remove Drive Shaft

NOTE: 755/756, 855/856, and 955 tractors have two additional side cap screws under each fender.

4. Remove panel (A).

NOTE: Panel need not be removed for driveshaft and charge pump repair.

5. Install in reverse order. Be sure depth control lever aligns with bolt head.

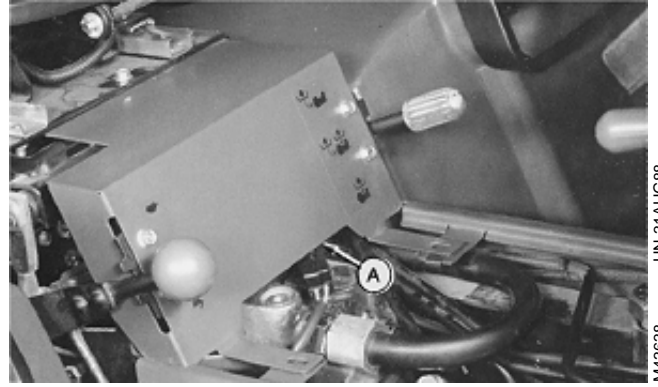

655 Shown

MX,HU,5005,7 -19-16OCT91

REMOVE DRIVE SHAFT

1. Loosen two bolts (A) of drive shaft coupler.

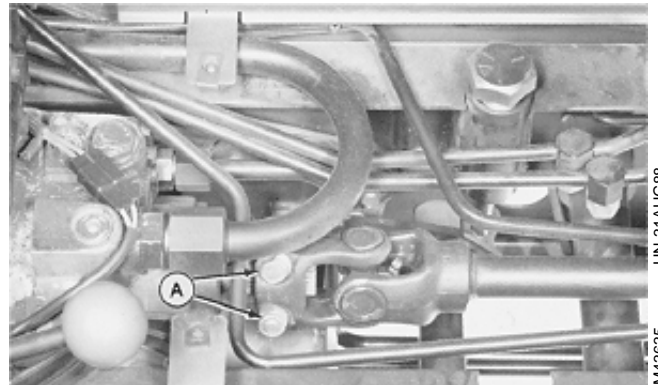

MX,HU,5005,8 -19-16OCT91

2. Remove six cap screws (A).

3. Push driveshaft (B) back to remove isolator (C).

4. Remove driveshaft.

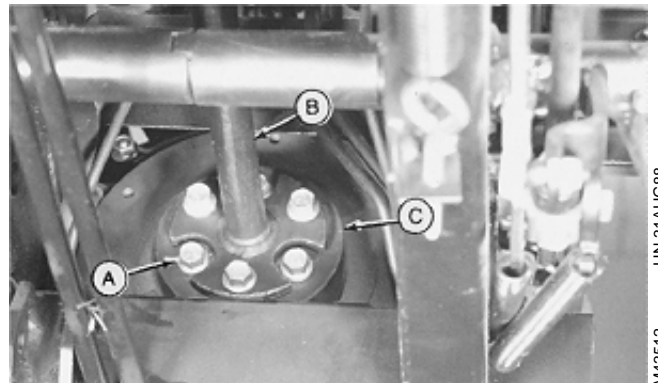

MX,HU,5005,9 -19-16OCT91

INSTALL DRIVE SHAFT

1. Put drive shaft (B) on transmission.
2. Install isolator (C). Be sure raised portion of unthreaded holes are toward engine.
3. Fasten isolator to engine with three longer cap screws and fasten drive shaft to isolator with three shorter cap screws (A). Tighten cap screws to 49 N·m (36 lb-ft).

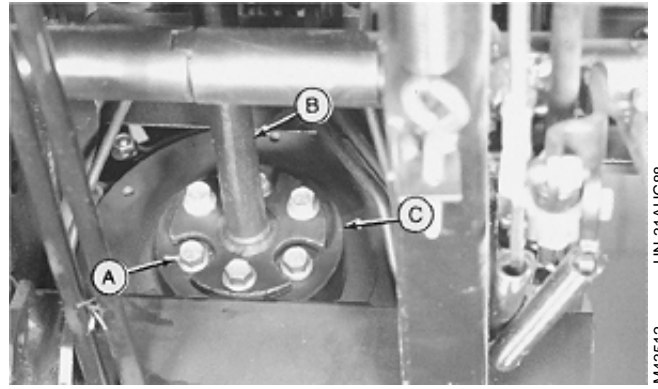

MX,HU,5005,10 -19-16OCT91

M43512 -UN-31AUG88

4. Tighten two bolts (A) of drive shaft coupler to 60 N·m (45 lb-ft).

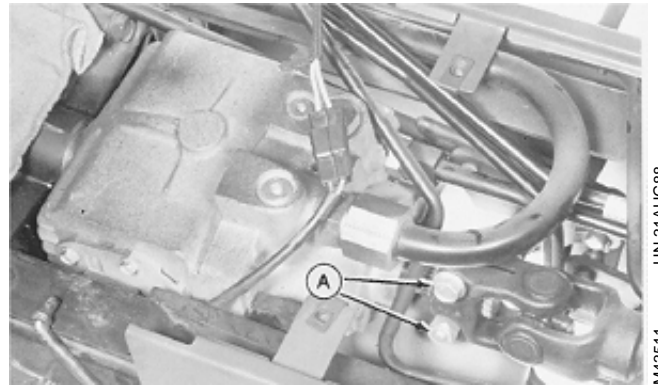

MX,HU,5005,11 -19-16OCT91

M43511 -UN-31AUG88

REMOVE AND INSTALL MFWD DRIVE SHAFT

1. Loosen clamps. Slide front and rear covers away from universal joints.

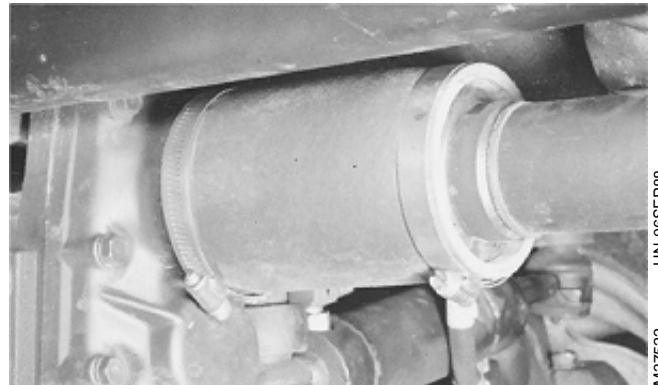

MX,HU,5005,11A -19-16OCT91

M37522 -UN-06SEP88

2. Drive pin out of front universal joint to remove shaft.
3. To install, align pin holes of drive shaft front U-joint and MFWD input shaft as you slide the shaft into position.
4. Fasten with spring pin removed earlier.
5. Fasten front cover in place with band clamps.
6. Fasten rear U-joint of drive shaft to transaxle output shaft.
7. Fasten rear cover in place with band clamps.

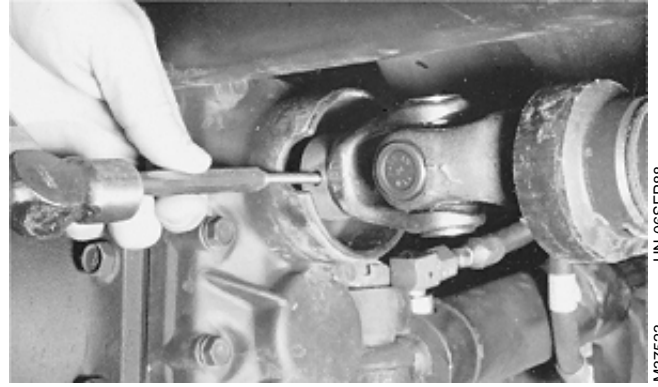

MX,HU,5005,12 -19-16OCT91

REMOVE AND INSTALL CHARGE PUMP

NOTE: Orientation of charge pump: Flat on charge pump housing must be on right-hand side. If turned 180°, pump will not function.

1. Remove two cap screws (A) to remove charge pump.



MX,HU,5005,13 -19-16OCT91

2. Remove pin (A). Inspect pin for damage or wear. Replace if necessary.
3. Inspect machined surface of transmission for severe scoring. If scoring is noted, replace transmission.
4. Clean and dry all parts. Machined surface of transmission must be clean.
5. Apply clean transmission oil on all internal parts.
6. Install pin (A). Apply petroleum jelly to pin and shaft to hold pin in place during installation of charge pump.
7. Be sure O-ring is in place on pump.
8. Torque cap screws (Step 1) to specification.



M43637 -UN-19JAN90

TORQUE SPECIFICATION

Charge Pump Cap Screws 37-50 N·m (27-37 lb-ft)

MX,HU,5005,14 -19-16OCT91

50
6

REMOVE HYDROSTATIC TRANSMISSION

1. Drain transaxle. Oil capacity is approximately 17 L (4.5 gal).
2. Remove the following:
 - Drawbar
 - Sheet Metal Panels (see procedures in this group)
 - Transmission Drive Shaft (see procedures in this group)
 - MFWD Drive Shaft (see procedures in this group).

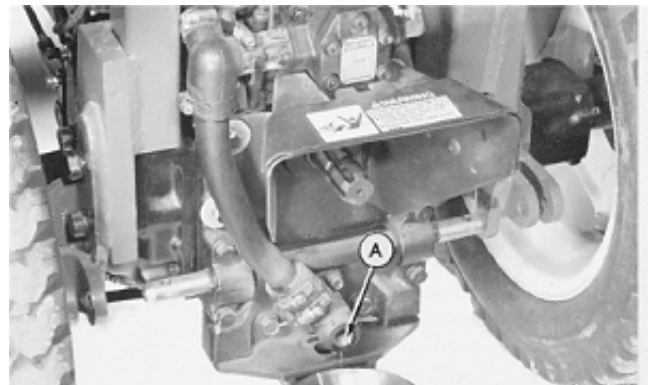

M43506 -UN-31AUG88

MX,HU,5005,16 -19-16OCT91

3. Disconnect spring (A) from lever (B).
4. Remove bolt (C) to disconnect linkage from transmission (D).

A—Spring
B—Transmission Neutral Return Lever
C—Bolt
D—Transmission

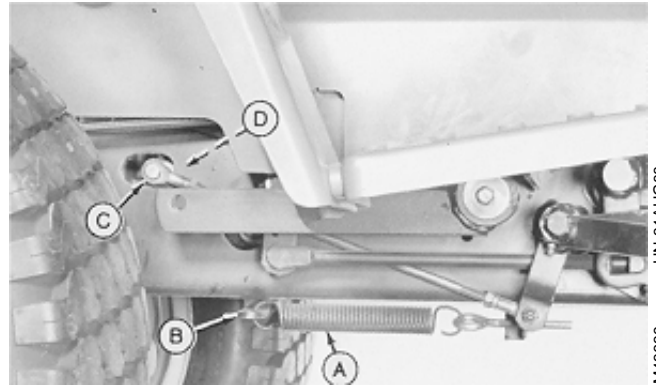

MX,HU,5005,17 -19-16OCT91

M43639 -UN-31AUG88

IMPORTANT: Close all openings with caps and plugs to keep dirt out of the hydraulic system.

5. Disconnect fitting (A). Loosen clamp on other end and turn tube (B) to permit transmission removal.
6. Disconnect line (C).
7. Disconnect lines (D).
8. Disconnect wiring (E).

A—Fitting
B—Suction Line
C—Steering Line
D—Oil Cooler Lines (2)
E—Neutral Start Wire

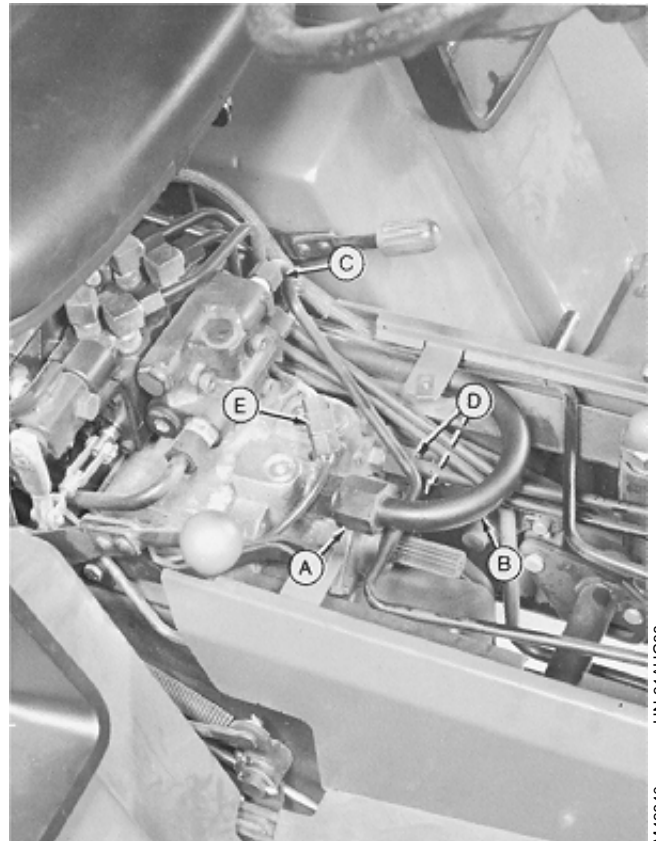

MX,HU,5005,18 -19-16OCT91

M43640 -UN-31AUG88

9. Fasten a lifting eye to the transmission and hold transmission with an overhead hoist.
10. Remove two cap screws (A).
11. Move transmission forward so that output gear clears transaxle, then lower transmission to remove it.

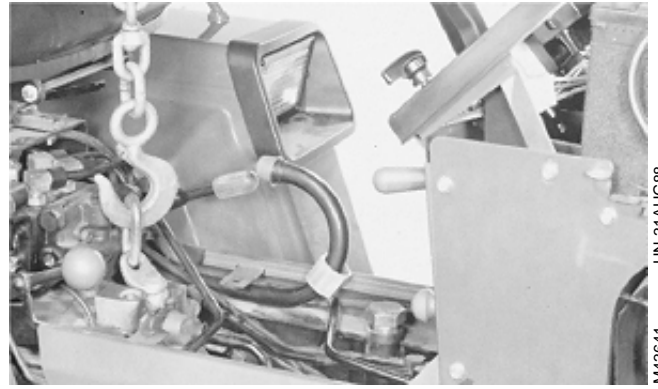

M43641 -UN-31AUG88

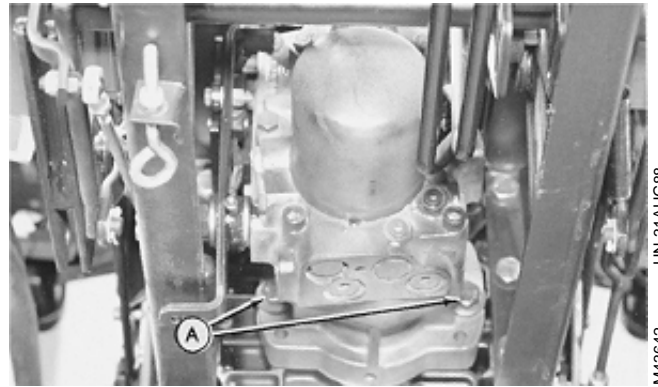

M43642 -UN-31AUG88

MX,HU,5005,19 -19-16OCT91

12. Remove cap screw and speed control lever (A).
13. Remove cap screw and neutral return lever (B).
14. Remove O-rings (C).
15. Remove three fittings (D).

- A—Cap Screw/Speed Control Lever
- B—Cap Screw/Neutral Return Lever
- C—O-ring
- D—Fittings

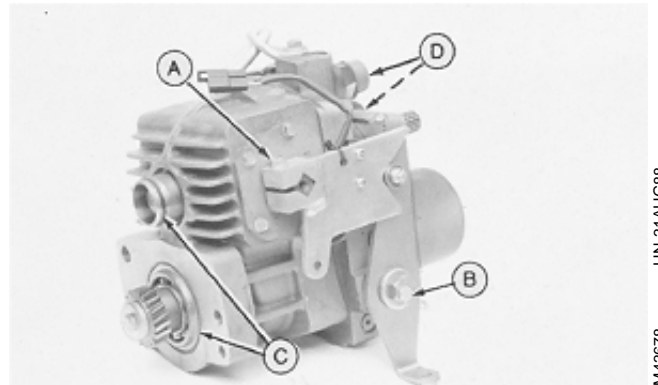

M43678 -UN-31AUG88

MX,HU,5005,20 -19-16OCT91

16. If neutral start switch is being replaced, be sure to install spacer (A) between switch and speed control lever.

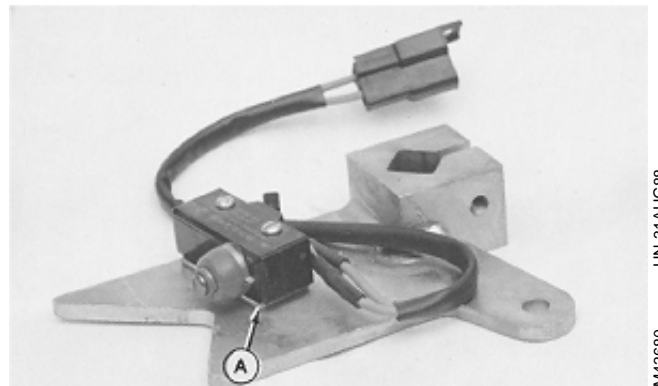

M43680 -UN-31AUG88

MX,HU,5005,21 -19-16OCT91

17. Inspect neutral return lever rollers (B). Replace them if they DO NOT turn freely.

18. Inspect bronze bushing in neutral return lever (D) for excessive wear on the inside diameter. If bushing is being replaced, be sure to align hole in bushing with grease fitting hole in lever. Ream bushing to 19.088 ± 0.025 mm (0.7515 ± 0.001 in.) diameter.

- A—Lock nut
- B—Roller (2 used)
- C—Washer (2 used)
- D—Neutral Return Lever
- E—Thin Washer
- F—Short Cap Screw
- G—Long Cap Screw
- H—Eccentric Pivot
- I—Seal Cover (2 used)
- J—Felt Seal (2 used)

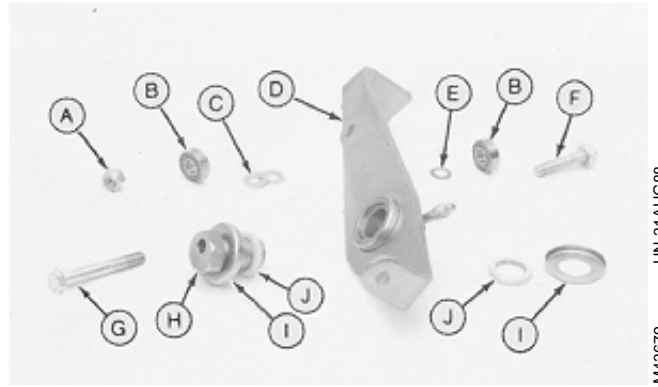

M43679 -UN-31AUG88

MX,HU,5005,22 -19-16OCT91

CROSS-SECTION VIEW—HYDROSTATIC TRANSMISSION

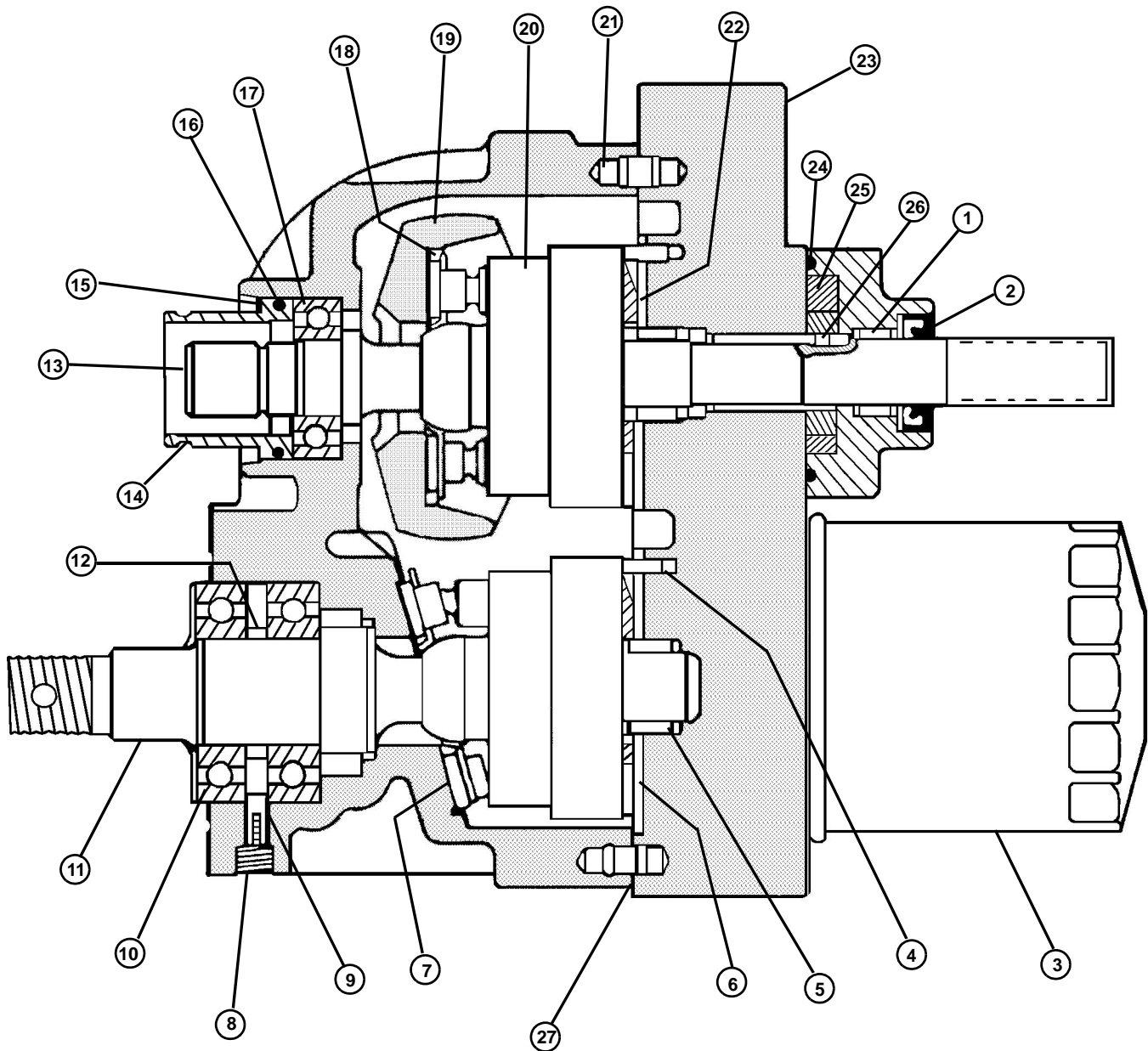

M85125

- | | | | |
|---|---|---|---------------------------|
| 1—Needle Bearing | 8—Drain Plug | 14—Seal Guide | 21—Pin (2 Used) |
| 2—Seal | 9—Bearing Retaining Pin | 15—Snap Ring | 22—Pump Valve Plate |
| 3—Filter | 10—Ball Bearing (2 Used) | 16—O-Ring | 23—Center Section |
| 4—Pin (2 used) | 11—Late Model Motor Shaft
(Early Models Are Not
Threaded) | 17—Ball Bearing | 24—O-Ring |
| 5—Needle Bearing (2 Used) | 12—Collar | 18—Thrust Plate | 25—Gerotor Charge
Pump |
| 6—Motor Valve Plate | 13—Pump Shaft | 19—Variable Swash Plate | 26—Gerotor Drive Pin |
| 7—Motor Cylinder Block
Assembly With Fixed
Thrust Plate | | 20—Pump Cylinder Block
Assembly (2 Used) | 27—Gasket |

DISASSEMBLE TRANSMISSION

1. Thoroughly clean outside surface of transmission using wire brush and solvent.
2. Install transmission on a bench fixture.
3. Remove and inspect charge pump (A). (See procedures previously in this section.)
4. Remove filter (B).

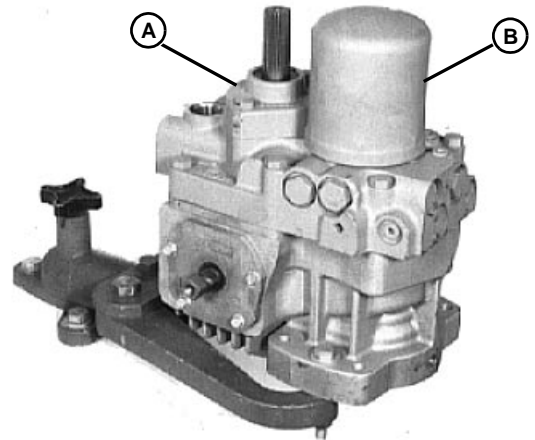

M43813

50
05
11

5. (Early Models) Rotate fixture 180°. Remove cap screw (A), and washer (B) to remove output shaft drive gear (C) (19 teeth).

IMPORTANT: Late model Hydrostatic Transmissions have cotter pin (F) and castle nut (D) assembly (Hydrostatic Driveshaft Kit AM118962 for positive gear retention) instead of cap screw (A) assembly.

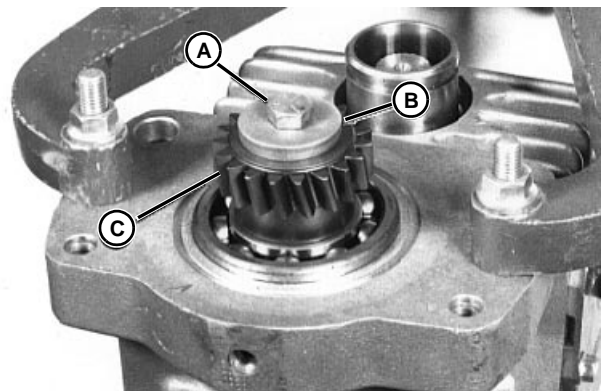

M43814

5. (Late Models) Rotate fixture 180°. Remove cotter pin (F), castle nut (D), and washer (E) to remove output shaft drive gear (C) (19 teeth).

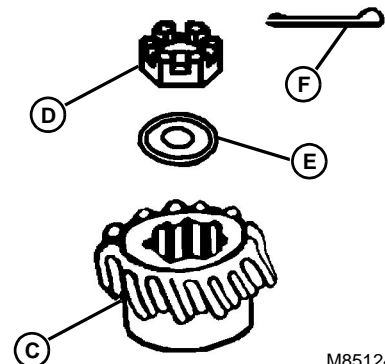

M85124

IMPORTANT: Do not allow internal parts to fall when removing center section.

6. Rotate fixture 180°. Loosen six cap screws (DO NOT remove). Remove transmission from bench fixture.

7. Put transmission on its side on a work bench and remove six cap screws, center section and gasket (A).

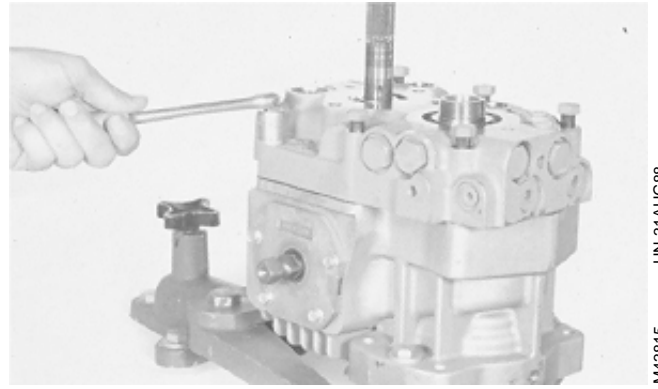

M43815
-UN-31/AUG88

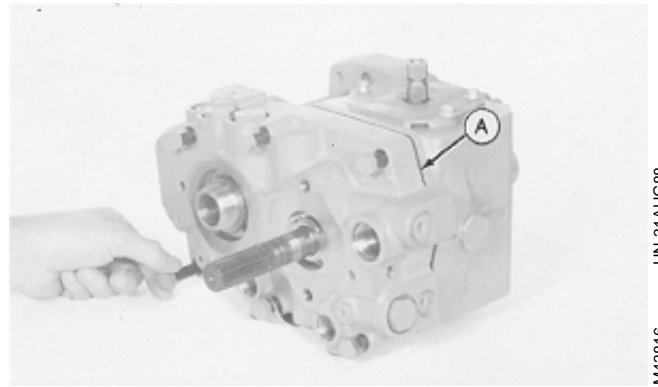

M43816
-UN-31/AUG88

MX,HU,5005,26 -19-16OCT91

IMPORTANT: Do not nick or scratch lapped or machined surfaces of the center section, valve plates or cylinder blocks.

Keep pump and motor components separate, they are not interchangeable.

8. Remove valve plates (A and B). If it is necessary to pry valve plates loose from center section, use a wooden dowel and pry only at dowel pin grooves.

If valve plates DO NOT come off with center section, remove valve plates from cylinder block assemblies.

It may be necessary to apply diesel fuel between valve plate and cylinder block to cut oil film.

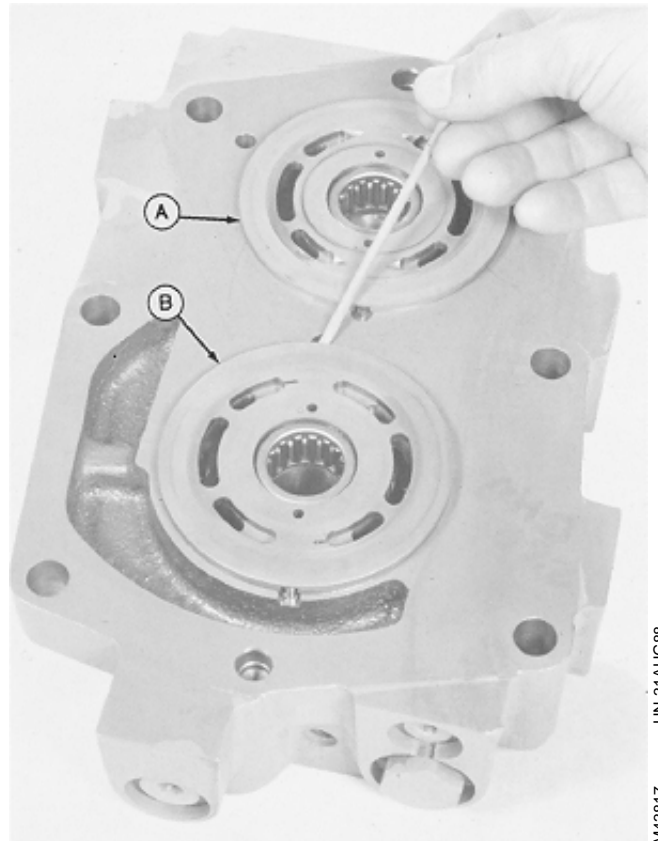

M43817
-UN-31/AUG88

MX,HU,5005,27 -19-16OCT91

9. Inspect valve plates. Valve plates should be flat, free of all nicks, burrs, scratches, and erosion around the ports. The bronze metal should show no scoring, smearing, or be discolored.

NOTE: Scoring is indicated by fine scratches or grooves cut into the plate.

When these scratches can be detected by feel, fingernail or lead pencil, the plate should be replaced.

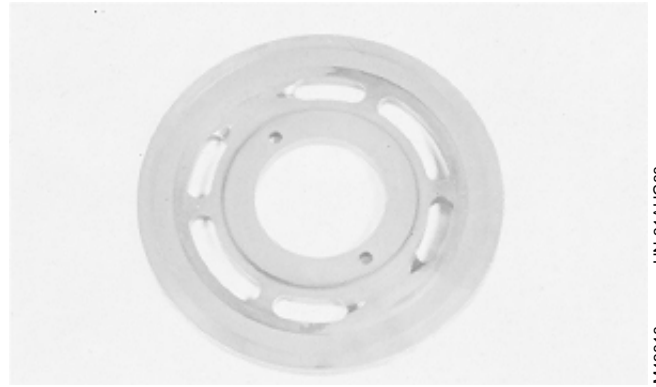

MX,HU,5005,28 -19-16OCT91

M43818 -UN-31AUG88

10. Inspect both bearings in center section. Replace if necessary. Remove bearing using a 2-jaw slide hammer puller.

11. For disassembly of center section, see Cross-Section View—Center Section later in this section.

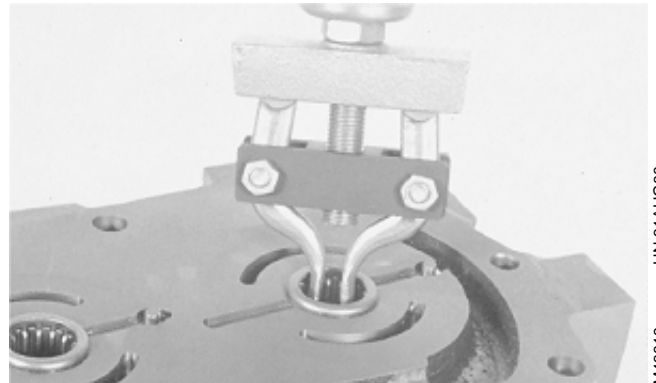

MX,HU,5005,29 -19-16OCT91

M43819 -UN-31AUG88

IMPORTANT: Do not nick or scratch lapped surface of cylinder blocks.

Piston-to-bore relationship need not be maintained; keep pump and motor components separate, they are not interchangeable.

12. Remove motor and pump cylinder blocks.

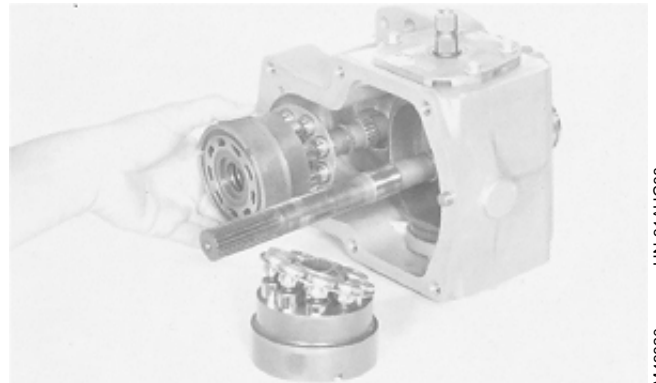

MX,HU,5005,30 -19-16OCT91

M43820 -UN-31AUG88

13. Inspect cylinder block assemblies.

IMPORTANT: Do not interchange pistons between motor and pump cylinder blocks. Pistons and cylinder blocks are matched.

Lift piston retainer and pistons from cylinder block. Check for free movement of pistons in cylinder bores.



MX,HU,5005,31 -19-16OCT91

M36111 -UN-29AUG88



Suggest:

If the above button click is invalid.

Please download this document

first, and then click the above link

to download the complete manual.

Thank you so much for reading

14. Remove and inspect all pistons.

Check barrel (B) for scoring, discoloration, or any signs of separation of slippers.

Check slipper (A) for scoring, smearing, rolled edges and a full 360° free rotation on barrel.

Check lubrication hole (C) for blockage. Clean with compressed air.

If any component of the piston is damaged, the cylinder block assembly must be replaced.

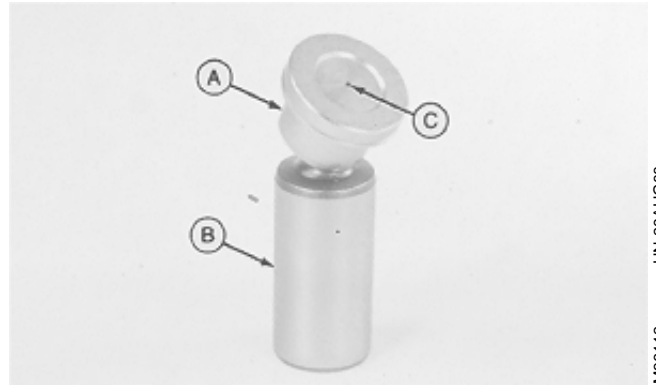

M36112 -UN-29AUG88

MX,HU,5005,32 -19-16OCT91

15. Remove and inspect both piston retainers.

Check retainer for flatness, nicks, burrs, and discoloration.

Check area around piston slippers (A) for scoring.

If any part of the piston retainer is damaged, the cylinder block assembly must be replaced.

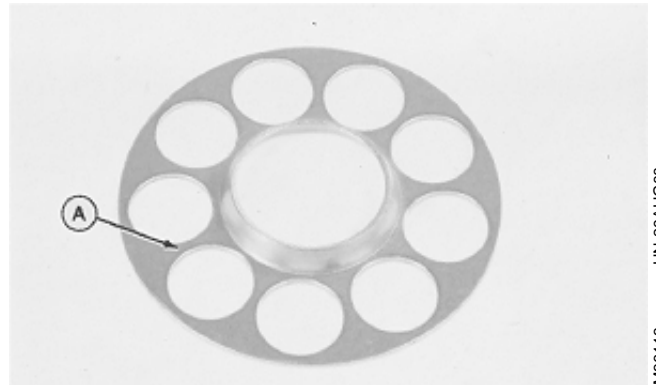

M36113 -UN-29AUG88

MX,HU,5005,33 -19-16OCT91

50
05
14

<https://www.ebooklibonline.com>

Hello dear friend!

Thank you very much for reading.

Enter the link into your browser.

The full manual is available for immediate download.

<https://www.ebooklibonline.com>