

JOHN DEERE
WORLDWIDE COMMERCIAL & CONSUMER
EQUIPMENT DIVISION

QuickTrak
647, 657 and 667

TM2042 June 2002

TECHNICAL MANUAL



JOHN DEERE

North American Version
Litho in U.S.A.

INTRODUCTION

Manual Description

This technical manual is written for an experienced technician and contains sections that are specifically for this product. It is a part of a total product support program.

The manual is organized so that all the information on a particular system is kept together. The order of grouping is as follows:

- Table of Contents
- Specifications
- General Information
- Identification Numbers
- Tools and Materials
- Component Location
- Schematics and Harnesses
- Theory of Operation
- Operation and Diagnostics
- Diagnostics
- Tests and Adjustments
- Repair
- Other

NOTE: Depending on the particular section or system being covered, not all of the above groups may be used.

The bleed tabs for the pages of each section will align with the sections listed on this page. Page numbering is consecutive from the beginning of the Safety section through the last section.

We appreciate your input on this manual. If you find any errors or want to comment on the layout of the manual please contact us.

Safety

Specifications and Information

Engine

Electrical

Hydrostatic Power Train

Brakes

Attachments

Miscellaneous

All information, illustrations and specifications in this manual are based on the latest information at the time of publication. The right is reserved to make changes at any time without notice.

COPYRIGHT© 2002
Deere & Co.
John Deere Worldwide Commercial and
Consumer Equipment Division
All rights reserved
COPYRIGHT©

SAFETY

Recognize Safety Information



MIF

This is the safety-alert symbol. When you see this symbol on your machine or in this manual, be alert to the potential for personal injury.

Follow recommended precautions and safe servicing practices.

Understand Signal Words

A signal word—DANGER, WARNING, or CAUTION—is used with the safety-alert symbol. DANGER identifies the most serious hazards.

DANGER or WARNING safety signs are located near specific hazards. General precautions are listed on CAUTION safety signs. CAUTION also calls attention to safety messages in this manual.

Replace Safety Signs

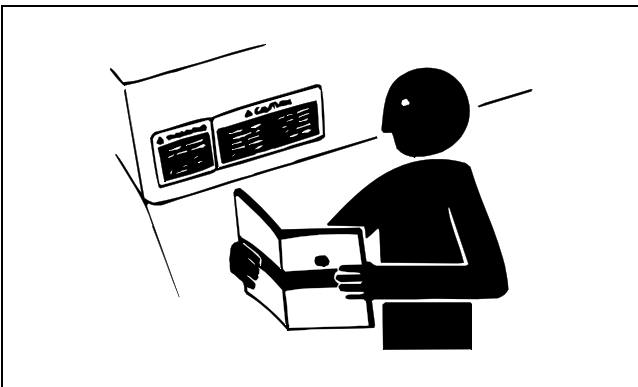

MIF

Replace missing or damaged safety signs. See the machine operator's manual for correct safety sign placement.

Be Prepared for Emergencies

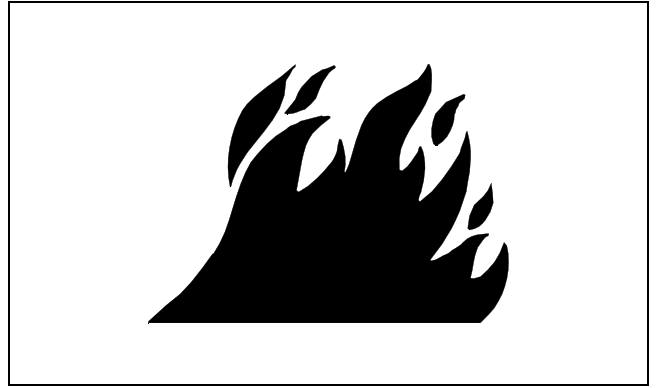

MIF

When you work around fuel, do not smoke or work near heaters or other fire hazards.

Store flammable fluids away from fire hazards. Do not incinerate or puncture pressurized containers.

Make sure machine is clean of trash, grease, and debris.

Do not store oily rags; they can ignite and burn spontaneously.

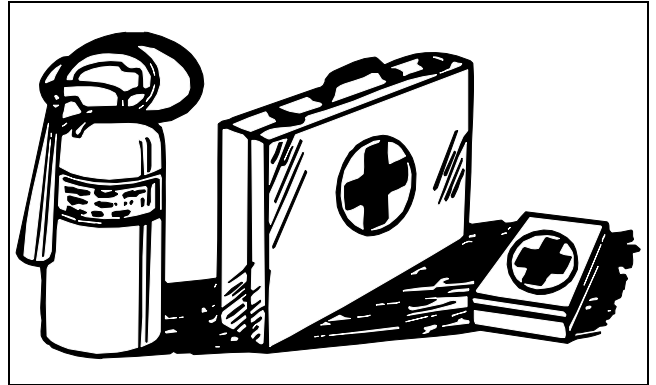

MIF

Be prepared if a fire starts.

Keep a first aid kit and fire extinguisher handy.

Keep emergency numbers for doctors, ambulance service, hospital, and fire department near your telephone.

<https://www.ebooklibonline.com>

Hello dear friend!

Thank you very much for reading.

Enter the link into your browser.

The full manual is available for immediate download.

<https://www.ebooklibonline.com>

SAFETY

Prevent Battery Explosions

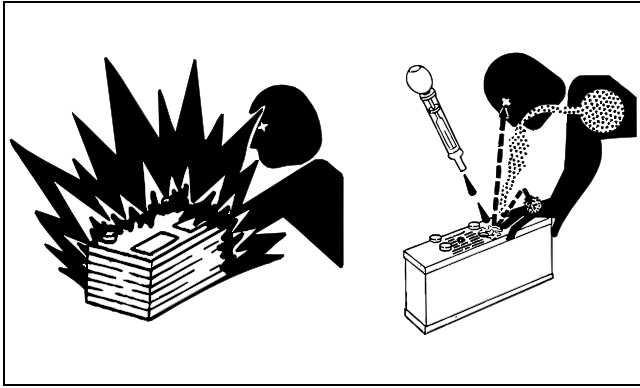

MIF

- Keep sparks, lighted matches, and open flame away from the top of battery. Battery gas can explode.
- Never check battery charge by placing a metal object across the posts. Use a voltmeter or hydrometer.
- Do not charge a frozen battery; it may explode. Warm battery to 16°C (60°F).

Prevent Acid Burns

- Sulfuric acid in battery electrolyte is poisonous. It is strong enough to burn skin, eat holes in clothing, and cause blindness if splashed into eyes.
- **Avoid acid burns by:**
 - a. Filling batteries in a well-ventilated area.
 - b. Wearing eye protection and rubber gloves.
 - c. Avoiding breathing fumes when electrolyte is added.
 - d. Avoiding spilling or dripping electrolyte.
 - e. Using proper jump start procedure.
- **If you spill acid on yourself:**
 - a. Flush your skin with water.
 - b. Apply baking soda or lime to help neutralize the acid.
 - c. Flush your eyes with water for 10-15 minutes.
 - d. Get medical attention immediately.
- **If acid is swallowed:**
 - a. Drink large amounts of water or milk.
 - b. Then drink milk of magnesia, beaten eggs, or vegetable oil.
 - c. Get medical attention immediately.

Avoid High-Pressure Fluids



MIF

Escaping fluid under pressure can penetrate the skin causing serious injury. Avoid the hazard by relieving pressure before disconnecting hydraulic or other lines. Tighten all connections before applying pressure. Search for leaks with a piece of cardboard. Protect hands and body from high-pressure fluids.

If an accident occurs, see a doctor immediately. Any fluid injected into the skin must be surgically removed within a few hours or gangrene may result. Doctors unfamiliar with this type of injury should reference a knowledgeable medical source. Such information is available from Deere & Company Medical Department in Moline, Illinois, U.S.A. Information may be obtained in the United States and Canada only by calling 1-800-822-8262.

Avoid Heating Near Pressurized Fluid Lines

Flammable spray can be generated by heating near pressurized fluid lines, resulting in severe burns to yourself and bystanders. Do not heat by welding, soldering, or using a torch near pressurized fluid lines or other flammable materials. Pressurized lines can be accidentally cut when heat goes beyond the immediate flame area.

SAFETY

Wear Protective Clothing

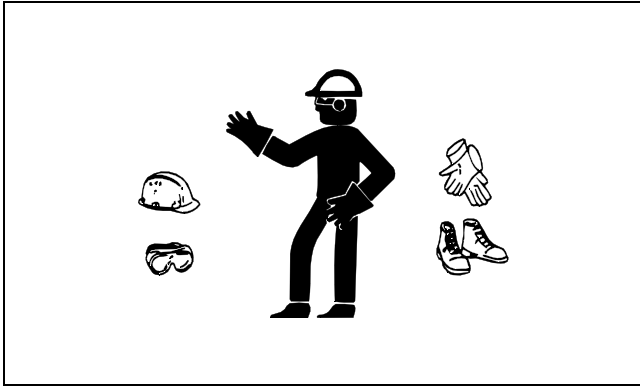

MIF

Wear close fitting clothing and safety equipment appropriate to the job.

Prolonged exposure to loud noise can cause impairment or loss of hearing. Wear a suitable hearing protective device such as earmuffs or earplugs to protect against objectionable or uncomfortable loud noises.

Operating equipment safely requires the full attention of the operator. Do not wear radio or music headphones while operating machine.

Service Machines Safely

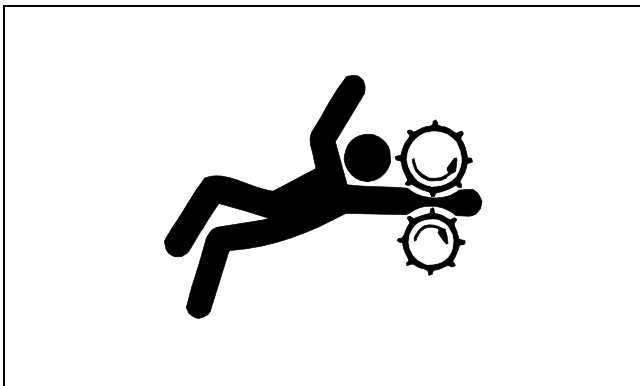

MIF

Tie long hair behind your head. Do not wear a necktie, scarf, loose clothing, or necklace when you work near machine tools or moving parts. If these items were to get caught, severe injury could result.

Remove rings and other jewelry to prevent electrical shorts and entanglement in moving parts.

Use Proper Tools

Use tools appropriate to the work. Makeshift tools and procedures can create safety hazards. Use power tools only to loosen threaded parts and fasteners. For loosening and tightening hardware, use the correct size tools. **DO NOT** use U.S. measurement tools on metric fasteners. Avoid bodily injury caused by slipping wrenches. Use only service parts meeting John Deere specifications.

Park Machine Safely

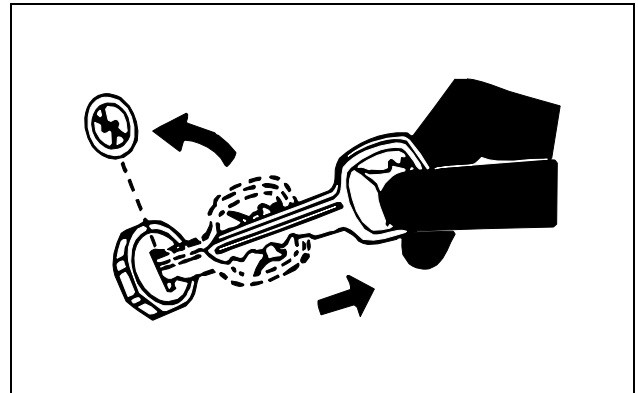

MIF

Before working on the machine:

1. Lower all equipment to the ground.
2. Stop the engine and remove the key.
3. Disconnect the battery ground strap.
4. Hang a "DO NOT OPERATE" tag in operator station.

Support Machine Properly and Use Proper Lifting Equipment

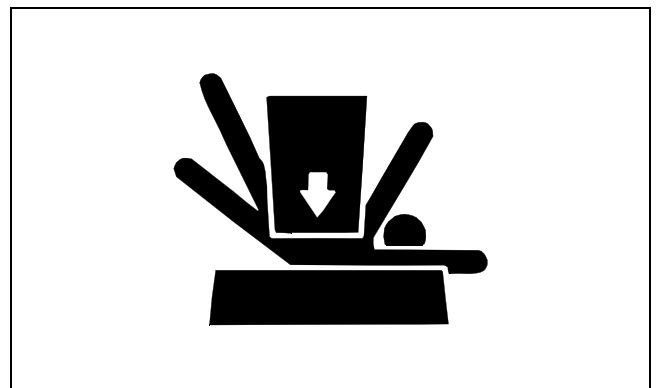

MIF

If you must work on a lifted machine or attachment, securely support the machine or attachment.

Do not support the machine on cinder blocks, hollow tiles, or props that may crumble under continuous load. Do not work under a machine that is supported solely by a jack.

SAFETY

Follow recommended procedures in this manual.

Lifting heavy components incorrectly can cause severe injury or machine damage. Follow recommended procedure for removal and installation of components in the manual.

Work in Clean Area

Before starting a job:

1. Clean work area and machine.
2. Make sure you have all necessary tools to do your job.
3. Have the right parts on hand.
4. Read all instructions thoroughly; do not attempt shortcuts.

Using High Pressure Washers

Directing pressurized water at electronic/electrical components or connectors, bearings, hydraulic seals, fuel injection pumps or other sensitive parts and components may cause product malfunctions. Reduce pressure and spray at a 45 to 90 degree angle.

Illuminate Work Area Safely

Illuminate your work area adequately but safely. Use a portable safety light for working inside or under the machine. Make sure the bulb is enclosed by a wire cage. The hot filament of an accidentally broken bulb can ignite spilled fuel or oil.

Work In Ventilated Area

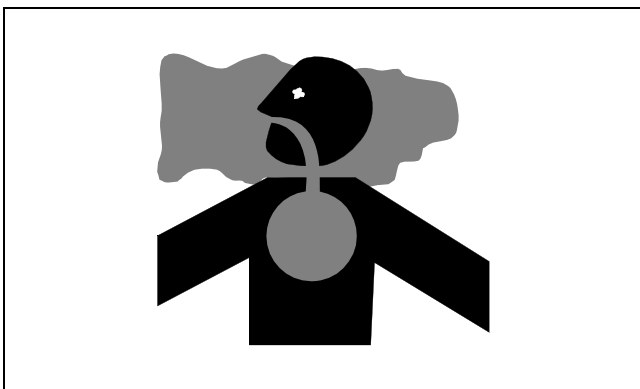

MIF

Engine exhaust fumes can cause sickness or death. If it is necessary to run an engine in an enclosed area, remove the exhaust fumes from the area with an exhaust pipe extension.

If you do not have an exhaust pipe extension, open the doors and get outside air into the area.

WARNING: California Proposition 65 Warning

Gasoline engine exhaust from this product contains chemicals known to the State of California to cause cancer, birth defects, or other reproductive harm.

Remove Paint Before Welding or Heating

Avoid potentially toxic fumes and dust. Hazardous fumes can be generated when paint is heated by welding, soldering, or using a torch. Do all work outside or in a well ventilated area. Dispose of paint and solvent properly. Remove paint before welding or heating: If you sand or grind paint, avoid breathing the dust. Wear an approved respirator. If you use solvent or paint stripper, remove stripper with soap and water before welding. Remove solvent or paint stripper containers and other flammable material from area. Allow fumes to disperse at least 15 minutes before welding or heating.

Avoid Harmful Asbestos Dust

Avoid breathing dust that may be generated when handling components containing asbestos fibers. Inhaled asbestos fibers may cause lung cancer.

Components in products that may contain asbestos fibers are brake pads, brake band and lining assemblies, clutch plates, and some gaskets. The asbestos used in these components is usually found in a resin or sealed in some way. Normal handling is not hazardous as long as airborne dust containing asbestos is not generated.

Avoid creating dust. Never use compressed air for cleaning. Avoid brushing or grinding material containing asbestos. When servicing, wear an approved respirator. A special vacuum cleaner is recommended to clean asbestos. If not available, apply a mist of oil or water on the material containing asbestos. Keep bystanders away from the area.

SAFETY

Service Tires Safely



MIF

Explosive separation of a tire and rim parts can cause serious injury or death.

- Do not attempt to mount a tire unless you have the proper equipment and experience to perform the job.
- Always maintain the correct tire pressure. Do not inflate the tires above the recommended pressure. Never weld or heat a wheel and tire assembly. The heat can cause an increase in air pressure resulting in a tire explosion. Welding can structurally weaken or deform the wheel.
- When inflating tires, use a clip-on chuck and extension hose long enough to allow you to stand to one side and NOT in front of or over the tire assembly. Use a safety cage if available.
- Check wheels for low pressure, cuts, bubbles, damaged rims or missing lug bolts and nuts.

Avoid Injury From Rotating Blades, Augers and PTO Shafts

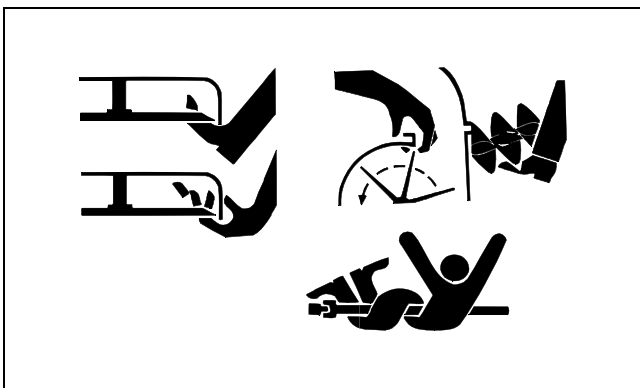

MIF

Keep hands and feet away while machine is running. Shut off power to service, lubricate or remove mower blades, augers or PTO shafts.

Handling Fuel Safely

Fuel and fuel vapors are highly flammable:

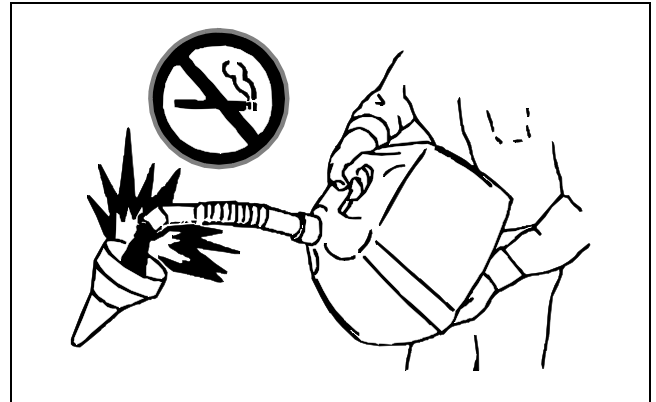

MIF

- Do not refuel machine while you smoke, when machine is near an open flame or sparks, or when engine is running. Stop engine and allow to cool before filling.
- Never remove the fuel cap or add fuel with the engine running.
- Never fill fuel tank or drain fuel from a machine in an enclosed area. Fill fuel tank outdoors.
- Prevent fires. Clean up spilled fuel immediately.
- Do not store machine with fuel in tank in a building where fumes may reach an open flame or spark.
- Prevent fire and explosion caused by static electric discharge. Use only non-metal, portable fuel containers approved by the Underwriter's Laboratory (U.L.) or the American Society for Testing & Materials (ASTM). If using a funnel, make sure it is plastic and has no screen or filter.



MIF

- Static electric discharge can ignite gasoline vapors in an ungrounded fuel container. Remove the fuel container from the bed of a vehicle or the trunk of a car and place on the ground away from the vehicle before filling. Keep nozzle in contact with container opening while filling.

SAFETY

- When practical, remove equipment from trailers or truck beds and refuel them on the ground. If this is not possible, use a portable, plastic fuel container to refuel equipment on a truck bed or trailer.
- For gasoline engines, do not use gas with methanol. Methanol is harmful to your health and to the environment.

Handle Chemical Products Safely

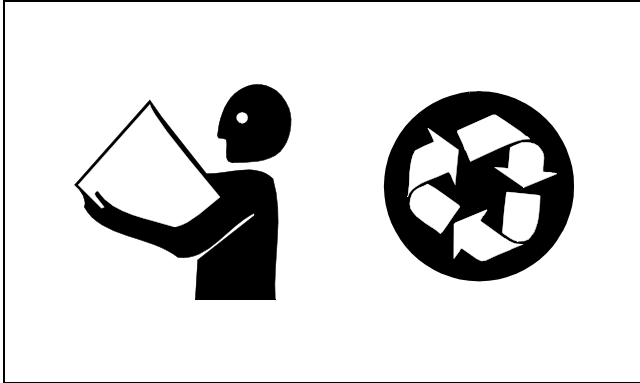

MIF

Direct exposure to hazardous chemicals can cause serious injury. Potentially hazardous chemicals used with John Deere equipment include such items as lubricants, coolants, paints, and adhesives.

A Material Safety Data Sheet (MSDS) provides specific details on chemical products: physical and health hazards, safety procedures, and emergency response techniques. Check the MSDS before you start any job using a hazardous chemical. That way you will know exactly what the risks are and how to do the job safely. Then follow procedures and recommended equipment.

Dispose of Waste Properly

Improperly disposing of waste can threaten the environment and ecology. Potentially harmful waste used with John Deere equipment include such items as oil, fuel, coolant, brake fluid, filters, and batteries. Use leakproof containers when draining fluids. Do not use food or beverage containers that may mislead someone into drinking from them. Do not pour waste onto the ground, down a drain, or into any water source. Inquire on the proper way to recycle or dispose of waste from your local environmental or recycling center, or from your John Deere dealer.

Live With Safety



MIF

Before returning machine to customer, make sure machine is functioning properly, especially the safety systems. Install all guards and shields.

GENERAL VEHICLE SPECIFICATIONS TABLE OF CONTENTS

Table of Contents

Specifications	9
Engine	9
Fuel System	10
Electrical.....	10
Battery	10
Power Train	10
Attachment Drive.....	11
Steering.....	11
Brakes	11
Attachment Lift	11
Tires	11
Dimensions.....	11
Weight	12
Mower Decks.....	12
Fastener Torques.....	13
Metric Fastener Torque Values	13
Metric Fastener Torque Value—Grade 7	14
Inch Fastener Torque Values	14
Hydraulic Fitting Service Recommendations	15
O-Ring Seal Service Recommendations.....	17
Gasoline.....	19
4-Cycle Engines - North America	19
4-Cycle Engines - Europe	20
Oils and Lubricants	22
Engine Oil	22
Hydrostatic Transmission and Hydraulic Oil	22
Grease.....	22
Alternative Lubricants.....	22
Synthetic Lubricants	23
Lubricant Storage	23
Mixing of Lubricants	23
Serial Number Locations	24
Machine Product Identification Number	24
Engine Serial Number	24
Mower Deck Serial Number	24

GENERAL VEHICLE SPECIFICATIONS SPECIFICATIONS

Specifications

Engine

Model 647

Make.....	Kawasaki
Type.....	Gasoline
Model.....	FH601V
Horsepower.....	14.2 kW (19 hp)
Displacement.....	675 cm ³ (41.2 cu in.)
Compression Ratio.....	8.1:1
Slow Idle Speed.....	1550 rpm
Fast Idle Speed.....	3600 rpm
Cylinders.....	2
Stroke/Cycle.....	4
Valves.....	Overhead Valves
Lubrication.....	Positive Displacement Pump
Oil Filter.....	Cartridge-Type, Full Flow
Crankcase Capacity (With Filter).....	1.6 L (1.7 qt)
Cooling System.....	Air Cooled
Air Cleaner.....	Paper Element with Foam Precleaner
Muffler.....	Horizontal Discharge Below Frame
Spark Plug Gap.....	0.75 mm (0.030 in.)
Spark Plug Torque.....	22 N•m (16 lb-ft)

Models 657 and 667

Make.....	Kawasaki
Type.....	Gasoline
Model.....	FH680V
Horsepower.....	17.1 kW (23.0 hp)
Displacement.....	675 cm ³ (41.2 cu in.)
Compression Ratio.....	8.1:1
Slow Idle Speed.....	1550 rpm
Fast Idle Speed.....	3400 rpm
Cylinders.....	2
Stroke/Cycle.....	4
Valves.....	Overhead Valves
Lubrication.....	Positive Displacement Pump
Oil Filter.....	Cartridge-Type, Full Flow
Crankcase Capacity (with Filter).....	1.6 L (1.7 qt)
Cooling System.....	Air Cooled
Air Cleaner.....	Paper Element with Foam Precleaner
Muffler.....	Horizontal Discharge Below Frame

GENERAL VEHICLE SPECIFICATIONS SPECIFICATIONS

Spark Plug Gap 0.75 mm (0.030 in.)
Spark Plug Torque 22 N•m (16 lb-ft)

Fuel System

Fuel Tank Location Right Side of Operator
Fuel Tank Capacity 22.7 L (6 gal)
Fuel Type (Minimum Octane) Unleaded, 87 Octane
Fuel Delivery Float-Type Side Draft Carburetor
Fuel Pump Vacuum Operated
Fuel Filter Replaceable In-Line

Electrical

Ignition Flywheel Magneto
Type of Starter Electric, Solenoid Shift
Charging System Flywheel Alternator

Battery

Voltage 12-volt
BCI group UL1
CCA Rating 340 Amps at -18°C (0°F)
Reserve Capacity 67 Minutes at 25 Amps
Specific Gravity (Minimum) 1.230 points
Load Test (Minimum) 255 amps for 15 seconds

Power Train

Type Hydrostatic Wheel Motor
Number of Speeds Variable
Pump Drive Belt
Controls Hand Levers
Hydraulic Reservoir Capacity (with Filter) 1.9 L (2 qt)
Hydraulic System Capacity 3.1 L (3.3 qt)

Travel Speed:

Forward 0 - 13.7 km/h (0 - 8.5 mph)
Reverse 0 - 6.2 km/h (0 - 4 mph)

Hydraulic Pump:

Make HydroGear
Model BDP-10A

Wheel Motor:

Make Parker
Model MF-12

GENERAL VEHICLE SPECIFICATIONS SPECIFICATIONS

Attachment Drive

Type V-Belt
Clutch Type Electric
Control Switch on Dash

Steering

Type Hydrostatic
Turning Radius Zero
Controls Hand Levers

Brakes

Main Hydraulic Resistance
Park Brake Tire Contact

Attachment Lift

Lift System Manual
Lift Lever Location Each Side of Mower Deck
Number of Cutting Height Positions 7
Cutting Height Range 38 - 114 mm (1-1/2 - 4-1/2 in.)
Adjustment Increments 13 mm (1/2 in.)

Tires

Size-Front Caster Wheels 13 x 5-6
Size-Rear (Model 647) 20 x 8-8
Size-Rear (Models 657 and 667) 20 x 10-8
Pressure-Front 110 - 138 kPa (16 - 20 psi)
Pressure-Rear 69 - 97 kPa (10 - 14 psi)

Dimensions

Wheelbase 1.32 m (52 in.)
Overall Height 1.14 m (45 in.)
Overall Length (Model 647) 1.6 m (65.5 in.)
Overall Length (Models 657 and 667) 1.7 m (68.5 in.)

Overall Width:

48-Inch Deck with Chute Up 1.36 m (53.5 in.)
48-Inch Deck with Chute Down 1.57 m (62 in.)
54-Inch Deck with Chute Up 1.46 m (57.5 in.)
54-Inch Deck with Chute Down 1.73 m (68 in.)
60-Inch Deck with Chute Up 1.61 m (63.5 in.)
60-Inch Deck with Chute Down 1.88 m (74 in.)

GENERAL VEHICLE SPECIFICATIONS SPECIFICATIONS

Weight

Model 647 with 48-inch 7-Iron Deck	408 kg (899 lb)
Model 657 with 54-Inch 7-Iron Deck	424 kg (934 lb)
Model 667 with 60-inch 7-Iron Deck	433 kg (955 lb)

Mower Decks

48-Inch 7-Iron Mower Deck

Type	Rotary, Side Discharge
Number of Cutting Blades	3
Overall Cutting Width	1.2 m (48 in.)

54-Inch 7-Iron Mower Deck

Type	Rotary, Side Discharge
Number of Cutting Blades	3
Overall Cutting Width	1.4 m (54 in.)























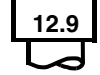

60-Inch 7-Iron Mower Deck

Type	Rotary, Side Discharge
Number of Cutting Blades	3
Overall Cutting Width	1.5 m (60 in.)

GENERAL VEHICLE SPECIFICATIONS FASTENER TORQUES

Fastener Torques

Metric Fastener Torque Values

Property Class and Head Markings	4.8   	8.8 9.8    	10.9  	12.9    
Property Class and Nut Markings	5   	10   	10   	12   

MIF (TS1163)

SIZE	Class 4.8		Class 8.8 or 9.8				Class 10.9				Class 12.9					
	Lubricated ^a		Dry ^a		Lubricated ^a		Dry ^a		Lubricated ^a		Dry ^a		Lubricated ^a		Dry ^a	
	N•m	lb-ft	N•m	lb-ft	N•m	lb-ft	N•m	lb-ft	N•m	lb-ft	N•m	lb-ft	N•m	lb-ft	N•m	lb-ft
M6	4.8	3.5	6	4.5	9	6.5	11	8.5	13	9.5	17	12	15	11.5	19	14.5
M8	12	8.5	15	11	22	16	28	20	32	24	40	30	37	28	47	35
M10	23	17	29	21	43	32	55	40	63	47	80	60	75	55	95	70
M12	40	29	50	37	75	55	95	70	110	80	140	105	130	95	165	120
M14	63	47	80	60	120	88	150	110	175	130	225	165	205	150	260	109
M16	100	73	125	92	190	140	240	175	275	200	350	225	320	240	400	300
M18	135	100	175	125	260	195	330	250	375	275	475	350	440	325	560	410
M20	190	140	240	180	375	275	475	350	530	400	675	500	625	460	800	580
M22	260	190	330	250	510	375	650	475	725	540	925	675	850	625	1075	800
M24	330	250	425	310	650	475	825	600	925	675	1150	850	1075	800	1350	1000
M27	490	360	625	450	950	700	1200	875	1350	1000	1700	1250	1600	1150	2000	1500
M30	675	490	850	625	1300	950	1650	1200	1850	1350	2300	1700	2150	1600	2700	2000
M33	900	675	1150	850	1750	1300	2200	1650	2500	1850	3150	2350	2900	2150	3700	2750
M36	1150	850	1450	1075	2250	1650	2850	2100	3200	2350	4050	3000	3750	2750	4750	3500

DO NOT use these hand torque values if a different torque value or tightening procedure is given for a specific

application. Torque values listed are for general use only and include a ±10% variance factor. Check tightness of

GENERAL VEHICLE SPECIFICATIONS FASTENER TORQUES

fasteners periodically. DO NOT use air powered wrenches.

Shear bolts are designed to fail under predetermined loads. Always replace shear bolts with identical grade.

Fasteners should be replaced with the same class. Make sure fastener threads are clean and that you properly start thread engagement. This will prevent them from failing when tightening.

When bolt and nut combination fasteners are used, torque values should be applied to the NUT instead of the bolt head.

Tighten toothed or serrated-type lock nuts to the full torque value.











^a "Lubricated" means coated with a lubricant such as engine oil, or fasteners with phosphate and oil coatings. "Dry" means plain or zinc plated (yellow dichromate - Specification JDS117) without any lubrication.

Reference: JDS-G200.

Metric Fastener Torque Value—Grade 7

Size	Steel or Gray Iron Torque		Aluminum Torque	
	N•m	lb-ft	N•m	lb-ft
M6	11	8	8	6
M8	24	18	19	14
M10	52	38	41	30
M12	88	65	70	52
M14	138	102	111	82
M16	224	165	179	132

Inch Fastener Torque Values

SAE Grade and Head Markings	1 or 2 ^b		5 5.1 5.2			8 8.2		
	No Marks 							
SAE Grade and Nut Markings	2		5			8		
No Marks 								

MIF (TS1162)

SIZE	Grade 1		Grade 2b				Grade 5, 5.1 or 5.2				Grade 8 or 8.2					
	Lubricated ^a		Dry ^a		Lubricated ^a		Dry ^a		Lubricated ^a		Dry ^a		Lubricated ^a		Dry ^a	
	N•m	lb-ft	N•m	lb-ft	N•m	lb-ft	N•m	lb-ft	N•m	lb-ft	N•m	lb-ft	N•m	lb-ft	N•m	lb-ft
1/4	3.7	2.8	4.7	3.5	6	4.5	7.5	5.5	9.5	7	12	9	13.5	10	17	12.5
5/16	7.7	5.5	10	7	12	9	15	11	20	15	25	18	28	21	35	26
3/8	14	10	17	13	22	16	27	20	35	26	44	33	50	36	63	46
7/16	22	16	28	20	35	26	44	32	55	41	70	52	80	58	100	75
1/2	33	25	42	31	53	39	67	50	85	63	110	80	120	90	150	115
9/16	48	36	60	45	75	56	95	70	125	90	155	115	175	130	225	160
5/8	67	50	85	62	105	78	135	100	170	125	215	160	215	160	300	225
3/4	120	87	150	110	190	140	240	175	300	225	375	280	425	310	550	400
7/8	190	140	240	175	190	140	240	175	490	360	625	450	700	500	875	650
1	290	210	360	270	290	210	360	270	725	540	925	675	1050	750	1300	975

GENERAL VEHICLE SPECIFICATIONS FASTENER TORQUES

1-1/8	470	300	510	375	470	300	510	375	900	675	1150	850	1450	1075	1850	1350
1-1/4	570	425	725	530	570	425	725	530	1300	950	1650	1200	2050	1500	2600	1950
1-3/8	750	550	950	700	750	550	950	700	1700	1250	2150	1550	2700	2000	3400	2550
1-1/2	1000	725	1250	925	990	725	1250	930	2250	1650	2850	2100	3600	2650	4550	3350

DO NOT use these hand torque values if a different torque value or tightening procedure is given for a specific application. Torque values listed are for general use only and include a $\pm 10\%$ variance factor. Check tightness of fasteners periodically. DO NOT use air powered wrenches.

Shear bolts are designed to fail under predetermined loads. Always replace shear bolts with identical grade.

Fasteners should be replaced with the same grade. Make sure fastener threads are clean and that you properly start thread engagement. This will prevent them from failing when tightening.

When bolt and nut combination fasteners are used, torque values should be applied to the NUT instead of the bolt head.

Tighten toothed or serrated-type lock nuts to the full torque

value.

^a "Lubricated" means coated with a lubricant such as engine oil, or fasteners with phosphate and oil coatings. "Dry" means plain or zinc plated (yellow dichromate - Specification JDS117) without any lubrication.

^b "Grade 2" applies for hex cap screws (not hex bolts) up to 152 mm (6-in.) long. "Grade 1" applies for hex cap screws over 152 mm (6-in.) long, and for all other types of bolts and screws of any length.

Reference: JDS-G200

Hydraulic Fitting Service Recommendations

Face Seal Fittings with Inch Stud End Torques

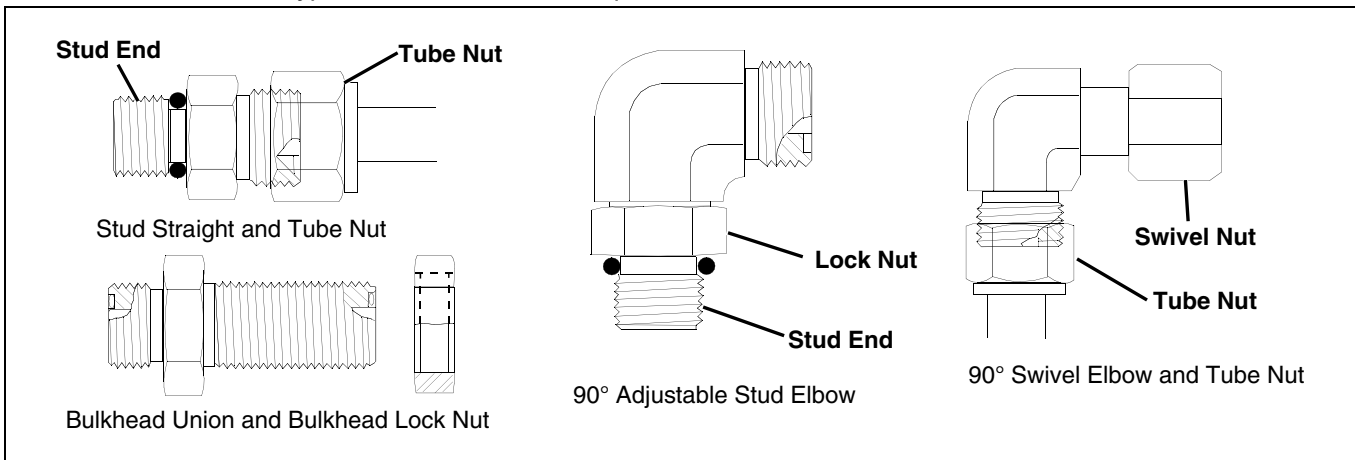

MIF

NOTE: Torque tolerance is + 15 - 20%.

Nominal Tube OD/Hose ID				Face Seal Tube/Hose End				O-Ring Stud Ends				
Metric Tube OD	Inch Tube OD			Thread Size	Tube Nut/ Swivel Nut Torque		Bulkhead Lock Nut Torque		Thread Size	Straight Fitting of Lock Nut Torque		
	mm	Dash Size	in.		mm	in.	N•m	lb-ft		N•m	lb-ft	in.
	-3	0.188	4.76							3/8-24	8	6

GENERAL VEHICLE SPECIFICATIONS FASTENER TORQUES

Nominal Tube OD/Hose ID				Face Seal Tube/Hose End					O-Ring Stud Ends		
Metric Tube OD	Inch Tube OD			Thread Size	Tube Nut/ Swivel Nut Torque		Bulkhead Lock Nut Torque		Thread Size	Straight Fitting of Lock Nut Torque	
	mm	Dash Size	in.		mm	in.	N•m	lb-ft		N•m	lb-ft
6	-4	0.250	6.35	9/16-18	16	12	12	9	7/16-20	12	9
8	-5	0.312	7.94						1/2-20	16	12
10	-6	0.375	9.52	11/16-16	24	18	24	18	9/16-18	24	18
12	-8	0.500	12.70	13/16-16	50	37	46	34	3/4-16	46	34
16	-10	0.625	15.88	1-14	69	51	62	46	7/8-14	62	46
	-12	0.750	19.05	1-3/16-12	102	75	102	75	1-1/16-12	102	75
22	-14	0.875	22.22	1-3/16-12	102	75	102	75	1-3/16-12	122	90
25	-16	1.000	25.40	1-7/16-12	142	105	142	105	1-5/16	142	105
32	-20	1.25	31.75	1-11/16-12	190	140	190	140	1-5/8-12	190	140
38	-24	1.50	38.10	2-12	217	160	217	160	1-7/8-12	217	160

Face Seal Fittings with Metric Stud End Torques

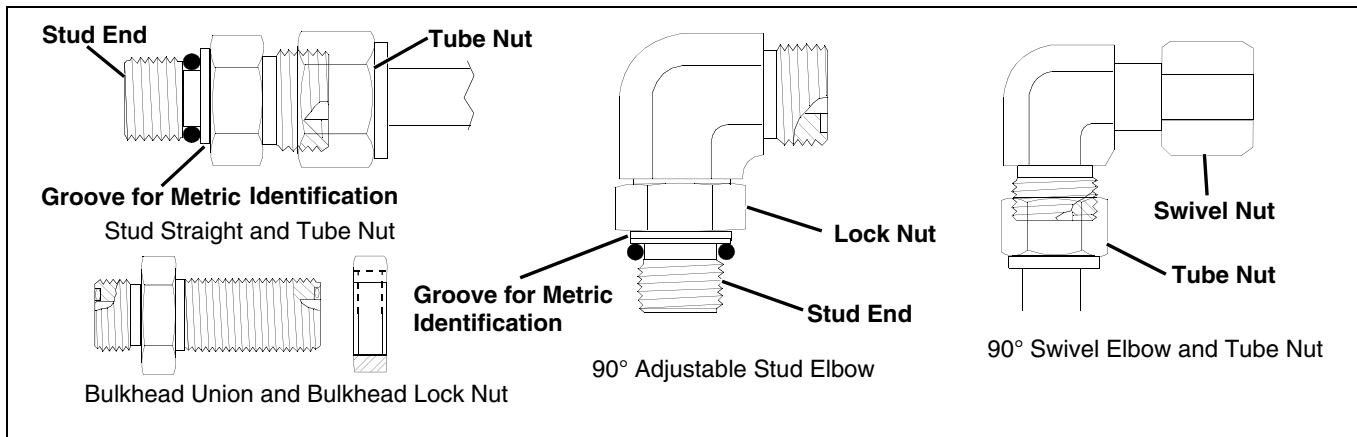

MIF

NOTE: Torque tolerance is + 15%.

GENERAL VEHICLE SPECIFICATIONS FASTENER TORQUES

Nominal Tube OD/Hose ID				Face Seal Tube/Hose End						O-Ring Stud Ends, Straight Fitting or Lock Nut					
Metric Tube OD	Inch Tube OD			Thread Size	Hex Size	Tube Nut/Swivel Nut Torque		Bulkhead Lock Nut Torque		Thread Size	Hex Size	Steel or Gray Iron Torque		Aluminum Torque	
	mm	Dash Size	in.			mm	in.	mm	N•m			lb-ft	N•m	lb-ft	mm
6	-4	0.250	6.35	9/16-18	17	16	12	12	9	M12x1.5	17	21	15.5	9	6.6
8	-5	0.312	7.94												
										M14x1.5	19	33	24	15	11
10	-6	0.375	9.52	11/16-16	22	24	18	24	18	M16x1.5	22	41	30	18	13
12	-8	0.500	12.70	13/16-16	24	50	37	46	34	M18x1.5	24	50	37	21	15
16	-10	0.625	15.88	1-14	30	69	51	62	46	M22x1.5	27	69	51	28	21
	-12	0.750	19.05	1-3/16-12	36	102	75	102	75	M27x2	32	102	75	46	34
22	-14	0.875	22.22	1-3/16-12	36	102	75	102	75	M30x2	36				
25	-16	1.000	25.40	1-7/16-12	41	142	105	142	105	M33x2	41	158	116	71	52
28										M38x2	46	176	130	79	58
32	-20	1.25	31.75	1-11/16-12	50	190	140	190	140	M42x2	50	190	140	85	63
38	-24	1.50	38.10	2-12	60	217	160	217	160	M48x2	55	217	160	98	72

O-Ring Seal Service Recommendations

O-Ring Face Seal Fittings

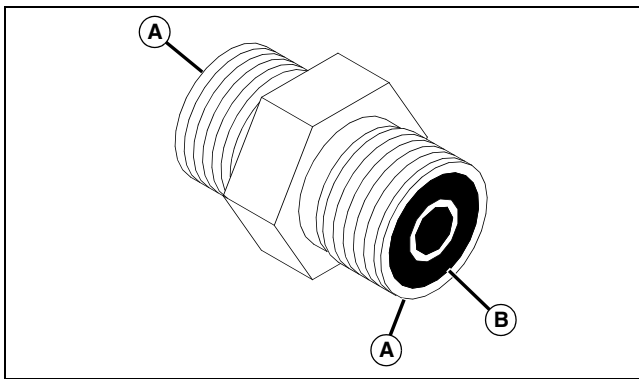

1. Inspect the fitting sealing surfaces (A). They must be free of dirt or defects.
2. Inspect the O-ring (B). It must be free of damage or defects.
3. Lubricate O-rings and install into groove using

petroleum jelly to hold in place.

4. Push O-ring into the groove with plenty of petroleum jelly so O-ring is not displaced during assembly.
5. Index angle fittings and tighten by hand-pressing joint together to ensure O-ring remains in place.

IMPORTANT: Avoid damage! DO NOT allow hoses or lines to twist when tightening fittings. Use two wrenches to tighten hose connections: one to hold the hose, and the other to tighten the swivel fitting.

6. Tighten fitting or nut to torque value shown on the chart per dash size stamped on the fitting. Do not allow hoses to twist when tightening fittings.

O-Ring Boss Fittings

1. Inspect O-ring boss seat. It must be free of dirt and defects. If repeated leaks occur, inspect for defects with a magnifying glass. Some raised defects can be removed with a slip stone.



Suggest:

If the above button click is invalid.

Please download this document

first, and then click the above link

to download the complete manual.

Thank you so much for reading

GENERAL VEHICLE SPECIFICATIONS FASTENER TORQUES

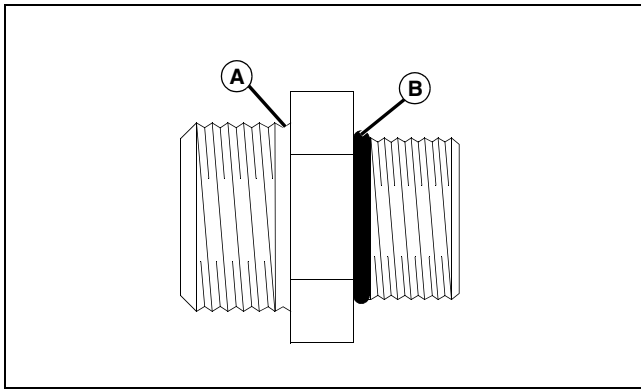

MIF

2. Put hydraulic oil or petroleum jelly on the O-ring (B). Place electrical tape over the threads to protect O-ring from nicks. Slide O-ring over the tape and into the groove (A) of fitting. Remove tape.

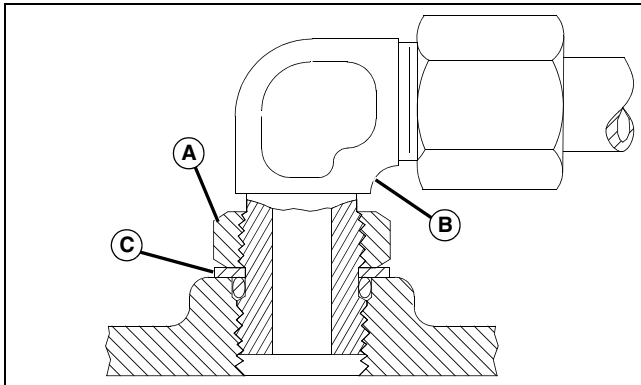

MIF

3. For angle fittings (B), loosen special nut (A) and push special washer (C) against threads so O-ring can be installed into the groove of fitting.
4. Turn fitting into the boss by hand until special washer or washer face (straight fitting) contacts boss face and O-ring is squeezed into its seat.
5. To position angle fittings, turn the fitting counter-clockwise a maximum of one turn.
6. Tighten straight fittings to torque value shown on chart. For angle fittings, tighten the special nut to value shown in the chart while holding body of fitting with a wrench.

Straight Fitting or Special Nut Torque

Thread Size	Torque ^a		Number of Flats ^b
	N•m	lb-ft	
3/8-24 UNF	8	(6)	2
7/16-20 UNF	12	(9)	2
1/2-20 UNF	16	(12)	2

Thread Size	Torque ^a		Number of Flats ^b
	N•m	lb-ft	
9/16-18 UNF	24	(18)	2
3/4-16 UNF	46	(34)	2
7/8-14 UNF	62	(46)	1-1/2
1-1/16-12 UN	102	(75)	1
1-3/16-12 UN	122	(90)	1
1-5/16-12 UN	142	(105)	3/4
1-5/8-12 UN	190	(140)	3/4
1-7/8-12 UN	217	(160)	1/2

a. Torque tolerance is ± 10 percent.

b. To be used if a torque wrench cannot be used. After tightening fitting by hand, put a mark on nut or boss; then tighten special nut or straight fitting the number of flats shown.

<https://www.ebooklibonline.com>

Hello dear friend!

Thank you very much for reading.

Enter the link into your browser.

The full manual is available for immediate download.

<https://www.ebooklibonline.com>