

335, 375, 385, 435 and 535 Round Balers



JOHN DEERE

TECHNICAL MANUAL

335, 375, 385, 435
and 535 Round Balers

TM1472 (06NOV95) English

John Deere Ottumwa Works
TM1472 (06NOV95)

LITHO IN U.S.A.
ENGLISH



Introduction

FOREWORD

This manual is written for an experienced technician. Essential tools required in performing certain service work are identified in this manual and are recommended for use.

Live with safety: Read the safety messages in the introduction of this manual and the cautions presented throughout the text of the manual.



This is the safety-alert symbol. When you see this symbol on the machine or in this manual, be alert to the potential for personal injury.

Technical manuals are divided in two parts: repair and operation and tests. Repair sections tell how to repair the components. Operation and tests sections help you identify the majority of routine failures quickly.

Information is organized in groups for the various components requiring service instruction. At the beginning of each group are summary listings of all applicable essential tools, service equipment and tools, other materials needed to do the job, service parts kits, specifications, wear tolerances, and torque values.

Technical Manuals are concise guides for specific machines. They are on-the-job guides containing only the vital information needed for diagnosis, analysis, testing, and repair.

Fundamental service information is available from other sources covering basic theory of operation, fundamentals of troubleshooting, general maintenance, and basic type of failures and their causes.

Contents

SECTION 10—GENERAL

- Group 05—Safety
- Group 10—Specifications
- Group 15—General Information
- Group 20—Lubrication

SECTION 20—Drive Train

- Group 05—General Information
- Group 10—Diagnosing Malfunctions
- Group 15—Drive Train Protection
- Group 20—PTO Hookup
- Group 25—Gear Case Repair
- Group 30—Rolls and Roll Drives

SECTION 30—HYDRAULICS

- Group 05—General Information
- Group 10—Diagnosing Malfunctions
- Group 15—335, 375 and 385 Hydraulic System and Tests
- Group 20—335, 375 and 385 Tensioning Valve Repair
- Group 25—335, 375 and 385 Hydra-Selector Valve
- Group 30—435 and 535 Hydraulic System and Tests
- Group 35—435 and 535 Single Spool Valve
- Group 40—Cylinders

SECTION 40—TWINE MECHANISM

- Group 05—Diagnosing Malfunctions
- Group 10—335, 375 and 385 Twine Wrap System
- Group 15—435 and 535 Automatic Twine Wrap System

SECTION 50—SURFACE WRAP SYSTEM (SERIAL NO. —CC010000)

- Group 05—Diagnosing Malfunctions
- Group 10—Diagnosing Malfunctions
- Group 15—Surface Wrap Repair

SECTION 51—SURFACE WRAP SYSTEM (SERIAL NO. 880001—)

- Group 05—General Information
- Group 10—Diagnosing Malfunctions
- Group 15—Surface Wrap Repair

SECTION 60—ELECTRICAL

- Group 05—General Information
- Group 10—Diagnosing Malfunctions
- Group 15—435/535 Electrical Diagnostics
- Group 20—Tests and Adjustments
- Group 25—Electrical Diagrams

SECTION 70—PICKUP

- Group 05—Diagnosing Malfunctions
- Group 10—Pickup Repair

SECTION 80—MISCELLANEOUS

- Group 05—Wheel Repair
- Group 10—Gate Repair
- Group 15—335 and 375 Tension Arm Repair
- Group 16—385 Tension Arm Repair
- Group 20—435 and 535 Tension Arm Repair
- Group 25—Tongue
- Group 30—Belt Repair
- Group 35—Main Frame Repair

Index

All information, illustrations and specifications in this manual are based on the latest information available at the time of publication. The right is reserved to make changes at any time without notice.

TM1472-19-06NOV95

COPYRIGHT© 1995
DEERE & COMPANY
Moline, Illinois

All rights reserved
A John Deere ILLUSTRATION™ Manual
Previous Editions
Copyright 1993, 1992, 1989 Deere & Company

<https://www.ebooklibonline.com>

Hello dear friend!

Thank you very much for reading.

Enter the link into your browser.

The full manual is available for immediate download.

<https://www.ebooklibonline.com>

Section 10 GENERAL

10

Contents

	Page
Group 05—Safety	10-05-1
Group 10—Specifications	
335, 375 and 385 Round Balers	10-10-1
435 and 535 Round Balers	10-10-3
Cap Screw Torque Values	10-10-5
Group 15—General Information	
335, 375 and 385 Baler Description	10-15-1
435 and 535 Baler Description	10-15-1
Group 20—Lubrication	
Before Lubrication	10-20-1
Extreme Pressure Grease	10-20-1
Gear Oil	10-20-2
Twine Wrap System	10-20-2
Alternative and Synthetic Lubricants	10-20-3

HANDLE FLUIDS SAFELY—AVOID FIRES

When you work around fuel, do not smoke or work near heaters or other fire hazards.

Store flammable fluids away from fire hazards. Do not incinerate or puncture pressurized containers.

Make sure machine is clean of trash, grease, and debris.

Do not store oily rags; they can ignite and burn spontaneously.



DX,FLAME -19-04JUN90

10
05
-JUN-23AUG88
TS227

PREPARE FOR EMERGENCIES

Be prepared if a fire starts.

Keep a first aid kit and fire extinguisher handy.

Keep emergency numbers for doctors, ambulance service, hospital, and fire department near your telephone.

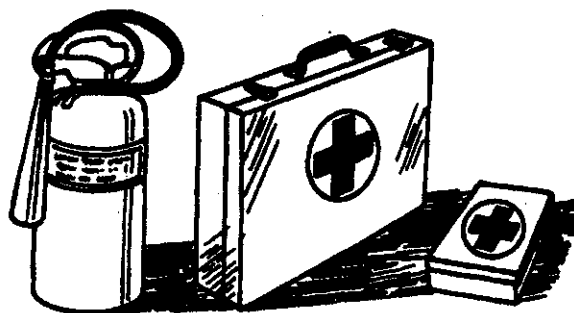

DX,FIRE2 -19-03MAR95

-JUN-23AUG88
TS291

AVOID HIGH-PRESSURE FLUIDS

Escaping fluid under pressure can penetrate the skin causing serious injury.

Avoid the hazard by relieving pressure before disconnecting hydraulic or other lines. Tighten all connections before applying pressure.

Search for leaks with a piece of cardboard. Protect hands and body from high pressure fluids.

If an accident occurs, see a doctor immediately. Any fluid injected into the skin must be surgically removed within a few hours or gangrene may result. Doctors unfamiliar with this type of injury should reference a knowledgeable medical source. Such information is available from Deere & Company Medical Department in Moline, Illinois, U.S.A.

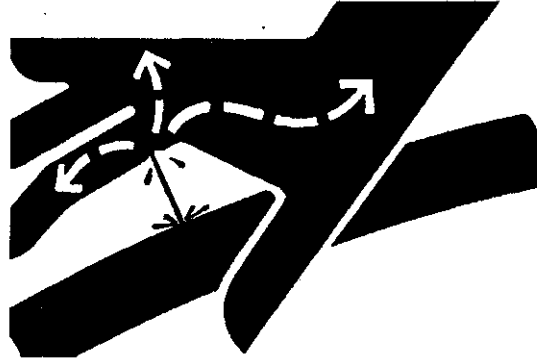

X9811 -JUN-23AUG88

DX,FLUID -19-03MAR93

SUPPORT MACHINE PROPERLY

Always lower the attachment or implement to the ground before you work on the machine. If you must work on a lifted machine or attachment, securely support the machine or attachment.

Do not support the machine on cinder blocks, hollow tiles, or props that may crumble under continuous load. Do not work under a machine that is supported solely by a jack. Follow recommended procedures in this manual.

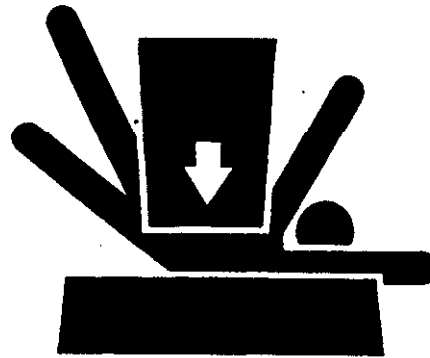

TS229 -JUN-23AUG88

DX,LOWER -19-04JUN90

WEAR PROTECTIVE CLOTHING

Wear close fitting clothing and safety equipment appropriate to the job.

Prolonged exposure to loud noise can cause impairment or loss of hearing.

Wear a suitable hearing protective device such as earmuffs or earplugs to protect against objectionable or uncomfortable loud noises.

Operating equipment safely requires the full attention of the operator. Do not wear radio or music headphones while operating machine.

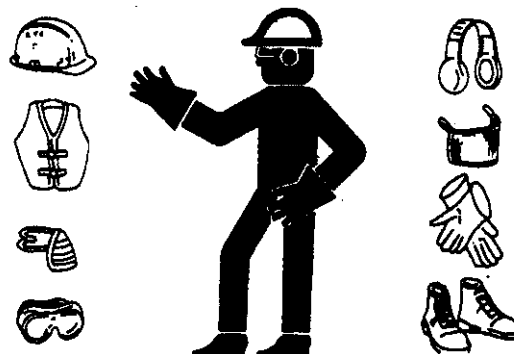

DX,WEAR -19-10SEP90

3375
-JUN-23AUG88
TS206

SERVICE MACHINES SAFELY

Tie long hair behind your head. Do not wear a necktie, scarf, loose clothing, or necklace when you work near machine tools or moving parts. If these items were to get caught, severe injury could result.

Remove rings and other jewelry to prevent electrical shorts and entanglement in moving parts.

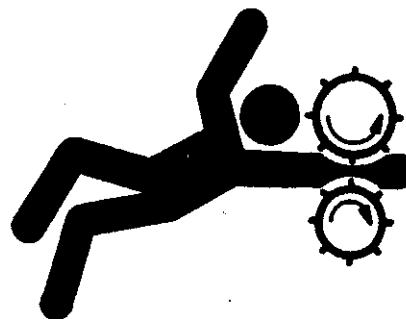

DX,LOOSE -19-04JUN90

-JUN-23AUG88
TS228

WORK IN VENTILATED AREA

Engine exhaust fumes can cause sickness or death. If it is necessary to run an engine in an enclosed area, remove the exhaust fumes from the area with an exhaust pipe extension.

If you do not have an exhaust pipe extension, open the doors and get outside air into the area.

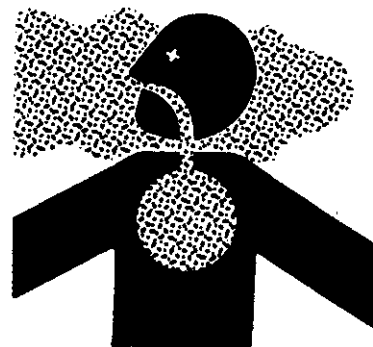

DX,AIR -19-04JUN90

-JUN-23AUG88
TS220

ILLUMINATE WORK AREA SAFELY

10
05
4

Illuminate your work area adequately but safely. Use a portable safety light for working inside or under the machine. Make sure the bulb is enclosed by a wire cage. The hot filament of an accidentally broken bulb can ignite spilled fuel or oil.

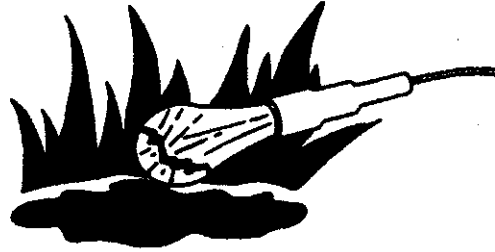

DX,LIGHT -19-04JUN90

-JUN-23AUG88
TS223

REPLACE SAFETY SIGNS

Replace missing or damaged safety signs. See the machine operator's manual for correct safety sign placement.

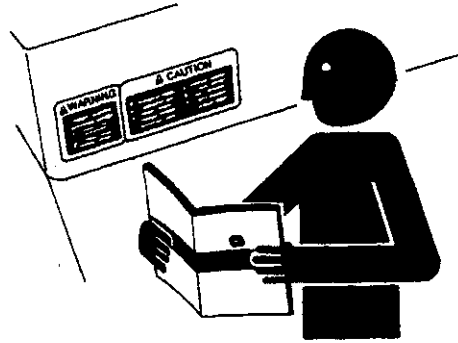

DX,SIGNS1 -19-04JUN90

-JUN-23AUG88
TS201

USE PROPER LIFTING EQUIPMENT

Lifting heavy components incorrectly can cause severe injury or machine damage.

Follow recommended procedure for removal and installation of components in the manual.

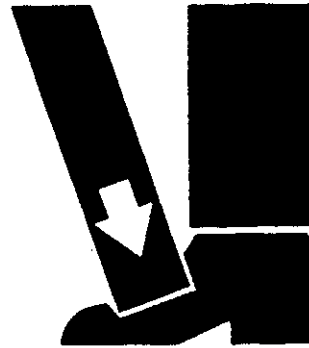

DX,LIFT -19-04JUN90

-JUN-23AUG88
TS226

SPECIFICATIONS

Item	Measurement	Specification
Shear Bolt (335-375-385) 1/4 x 2 in. Grade 8	Torque	18 N·m (13 lb-ft)
Drive Slip Clutch (435-535):		
540 RPM	Spring Length	35 mm (1-3/8 in.) from end coil-to-end coil
1000 RPM	Spring Length	41 mm (1-5/8 in.) from end coil-to-end coil

EX.1472.2015,A -19-11MAR93

SHEAR BOLT REPLACEMENT
(335—375—385)

When replacing shear bolt, use only a 1/4 x 2-in., grade 8 cap screw and lock nut (A).

IMPORTANT: Tighten lock nut (A) to 18 N·m (13 lb-ft).

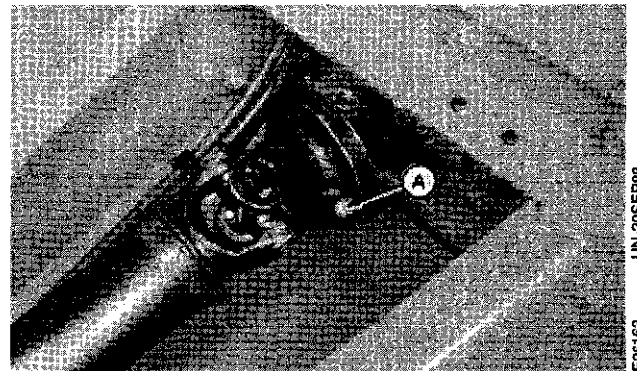

EX.1472.2015,B -19-11MAR93

20
15

E26163 -UN-20SEP98

**USE CORRECT SHEAR BOLT
(335—375—385)**

Use shear bolts specified. Shank (A) of shear bolt must extend through shear plane (B).

NOTE: Use of shorter bolts than those specified will place threads in shear plane resulting in bolts being sheared at lower values, and more often.

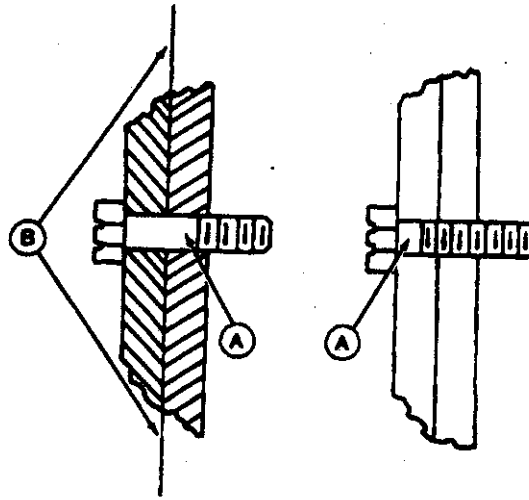

Correct

Wrong

EX,1472,2015,C -19-11MAR93

E27750 -19-07APP89

**DISASSEMBLE DRIVELINE SHEAR BOLT
HUB (335—375—385)**

1. Remove plug (A).
2. Fill opening with solvent.

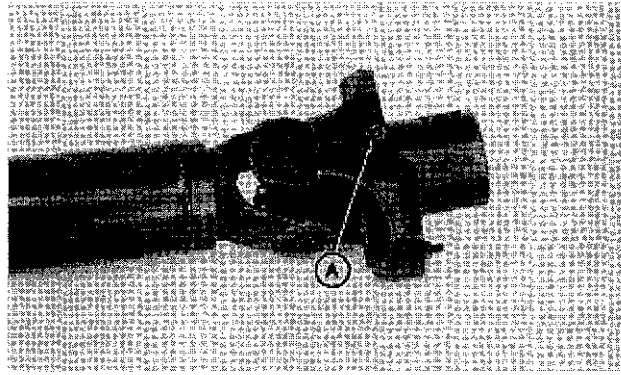

EX,1472,2015,D -19-11MAR93

E27753 -JUN-20SEP88

3. Remove shear bolt (A).
4. Turn driveline over and rotate hub (B).
5. Thirty-one ball bearings (C) should come out.
6. Remove hub (B).

- A—Shear Bolt
- B—Hub
- C—Ball Bearings
- D—Plug

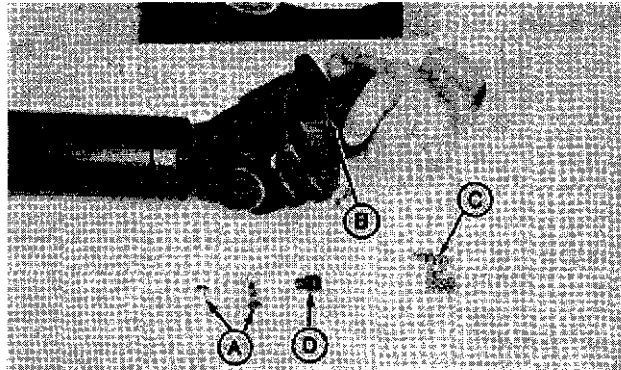

EX,1472,2015,E -19-21JUL89

E27754 -JUN-20SEP88

INSPECT DRIVELINE

Check hub (A) for galling and excessive wear.

Check bearings and guides for breakage.

Check bearing and cross assemblies for looseness and wear.

Clean all parts before assembling.

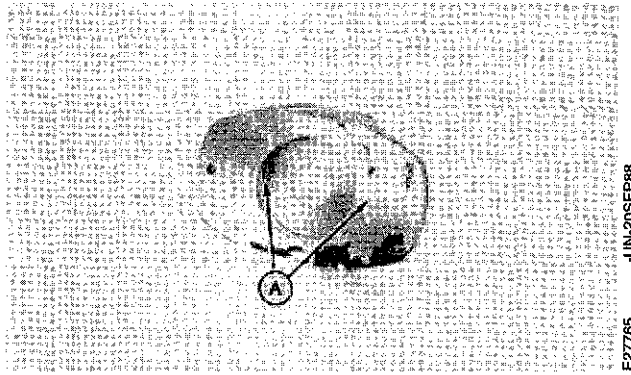

EX,1472,2015,F -19-11MAR93

E27765 -UN-20SEP88 20 35

ADJUST DRIVE SLIP CLUTCH (435—535)

Check slip clutch spring length if excessive slipping occurs during operation or if it has been disassembled.

For 540 rpm, the clutch is properly adjusted when dimension (A) is 35 mm (1-3/8 in.) from end coil to end coil.

For 1000 rpm, the clutch is properly adjusted when dimension (A) is 41 mm (1-5/8 in.) from end coil to end coil.

IMPORTANT: The slip clutch has been designed to furnish protection to the drive train; overtightening will decrease this protection.

To adjust slip clutch:

1. Shut off tractor engine.
2. Loosen jam nut (B).
3. Turn spring adjusting bolt (C) until proper spring dimension (A) is attained.
4. Tighten jam nut (B).

NOTE: For proper operation pressure plate warpage cannot exceed 1.5 mm (1/16 in.).

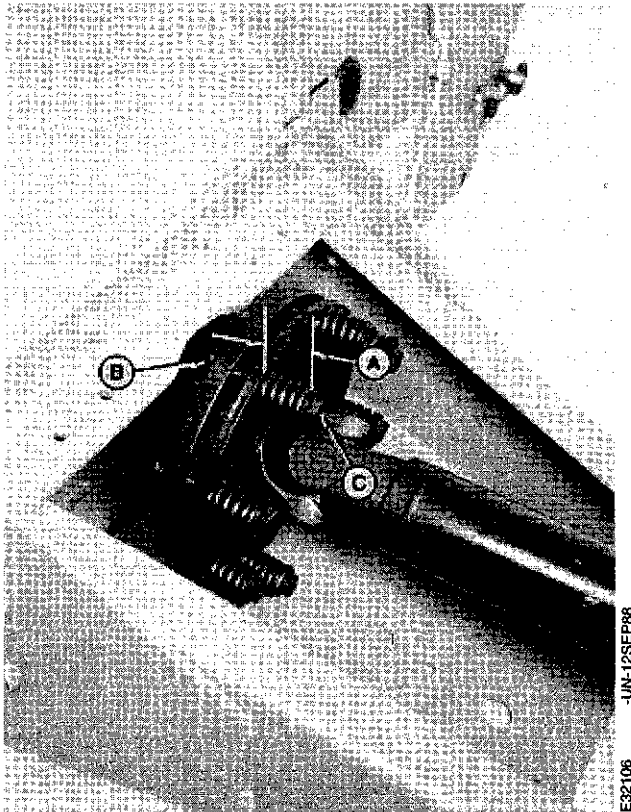

- A—35 mm (1-3/8 in.) 540 rpm
41 mm (1-5/8 in.) 1000 rpm
- B—Jam Nut
- C—Adjusting Bolt

EX,1472,2015,G -19-06NOV95

E32106 -UN-12SEP88

SPECIFICATIONS

Item	Measurement	Specification
Shear Bolt	Torque	18 N-m (13 lb-ft)

EX,1472,2020,U -19-11MAR93

**REMOVE CONSTANT VELOCITY DRIVELINE
(435—535)**

1. Remove two lock nuts and cap screws (A).

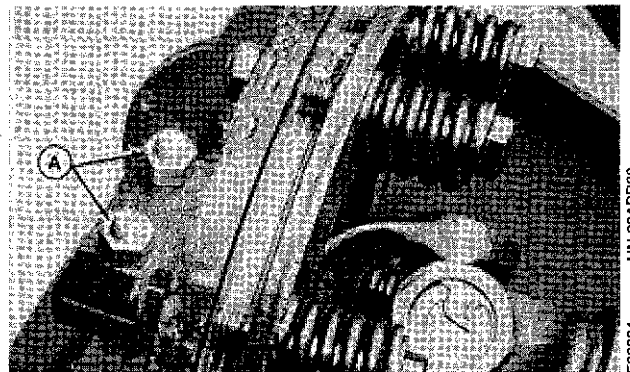

-UN-20APR89
E32804

EX,1472,2020,A -19-11MAR93

**REMOVE CONSTANT VELOCITY DRIVELINE
(335—375—385)**

1. Remove lock nut, cap screw (A) and driveline (B).
2. Separate the two halves for ease in handling.

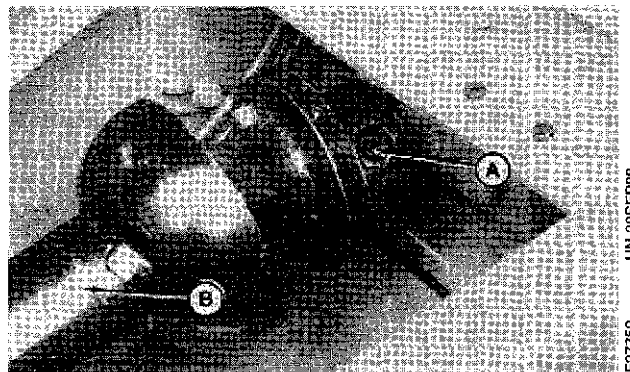

-UN-20SEP88
E27752

EX,1472,2020,B -19-11MAR93

**DISASSEMBLE CONSTANT VELOCITY
DRIVELINE**

1. Remove front half of PTO from rear half.
2. Using a screwdriver, push inward to remove snap ring (A). Remove shield assembly (B). Wipe grease from assembly.

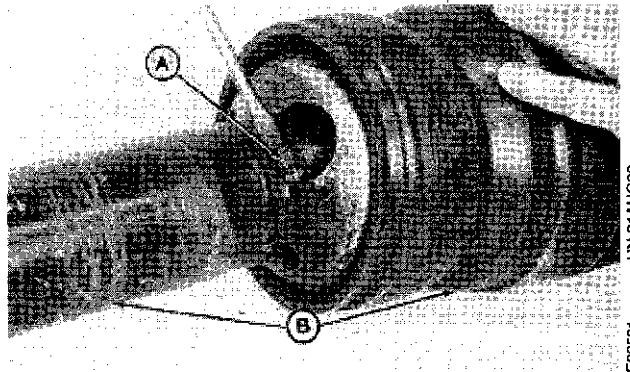

-UN-21AUG89
E33521

EX,1472,2020,C -19-11MAR93

PTO Hookup/Remove and Replace Front and/or Rear Cross Constant Velocity PTO

3. Remove four snap rings (A).

4. Remove cups (B) from center housing (E). Separate and yoke with cross from center housing.

- A—Snap Ring
- B—Cups
- C—Cross
- D—Yoke
- E—Center Housing

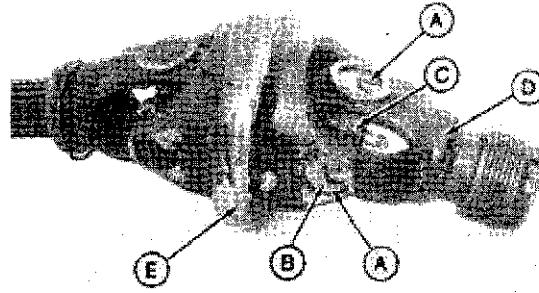

EX,1472,2020,D -19-11AUG89

E33522 -JUN-21AUG89

5. Remove cups (A) and cross (B) from end yoke. Clean center housing and end yoke.

6. Inspect parts (pin and center plate in center housing, cross, and yoke bores) for wear and galling.

7. Check for free operation of slide-lock collar and pawls. Collar and pawls must be free to move.

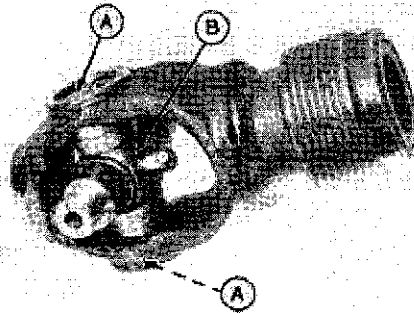

EX,1472,2020,E -19-11AUG89

E33523 -JUN-21AUG89

8. Install lubrication fitting (A) in new cross and align with long leg of cross.

9. Install short legs of cross cups and snap ring in end yoke with fitting pointing away from centering ball (B).

NOTE: When installing end yoke in center housing, flat side of ball **MUST** be toward center disk.

10. Pin (C) must be inserted in end yoke ball and flat side of ball (B) must be toward the center disk when installing end yoke in center housing.

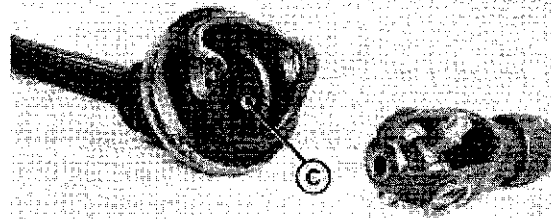
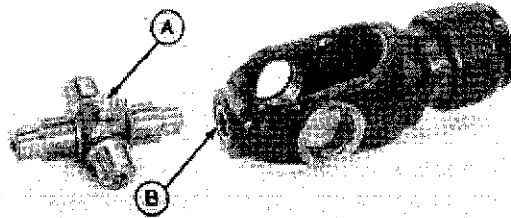

EX,1472,2020,F -19-06NOV95

E33524 -JUN-21AUG89

E33525 -JUN-21AUG89

PTO Hookup/Remove and Replace Front and/or Rear Cross Constant Velocity PTO

11. Align fittings (A) in the front and rear crosses with fitting (B) in the front face of center housing. Turn fitting (A) in the cross if necessary for alignment.

NOTE: This alignment will provide easier greasing of the joint assembly (not requiring joint rotation to locate fittings with the shielding in place).

If both constant velocity crosses are removed and replaced, or if the center housing is replaced, be sure to orient the center housing with the fitting (B) toward the front of the hookup when reinstalling parts.

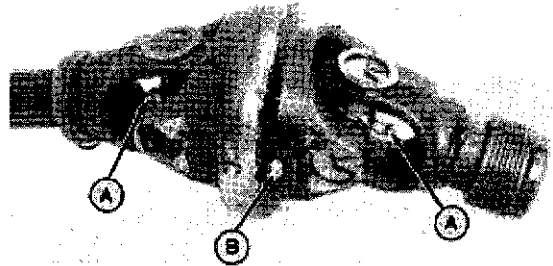

E33526 -UN-21AUG89

EX,1472,2020,G -19-11AUG89

12. Install cross, cups, and snap rings in center housing.

NOTE: To insure correct seating, and eliminate any possible tightness, strike forged surfaces of yoke ears a sharp blow with a mallet. This will ensure a free flexing joint.

EX,1472,2020,H -19-11AUG89

13. Lubricate four fittings (A), (B), and (C).

14. Grease splined shaft.

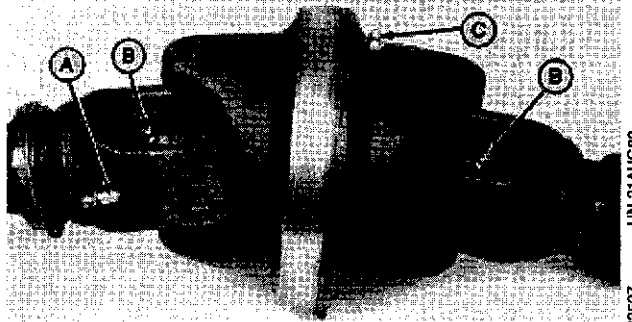

E33527 -UN-21AUG89

EX,1472,2020,I -19-11AUG89

PTO Hookup/Remove and Replace Front and/or Rear Cross Constant Velocity PTO

15. Slide shield in place over constant velocity unit.
16. Using two screwdrivers, pop snap ring in groove in shield. Be sure snap ring is seated all the way around. Check for free rotation of shield relative to the shaft and joint assembly.

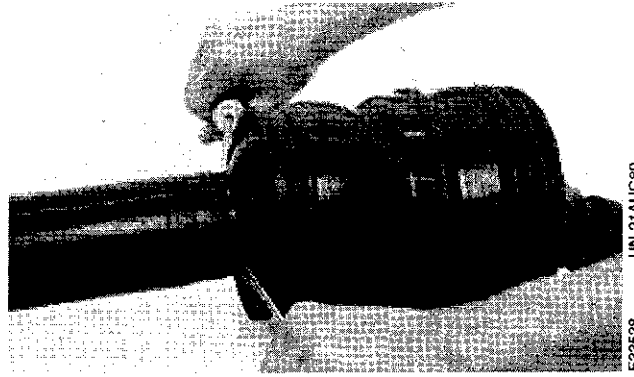

EX,1472.2020,J -19-11AUG89

-JUN-21AUG89
E33628

20
20
4

17. Locate timing mark on shaft and align groove inside splined tube. Slide shaft in splined tube.
18. Lubricate telescoping members.

EX,1472.2020,K -19-11AUG89

PTO UNIT WITH SHEAR BOLT

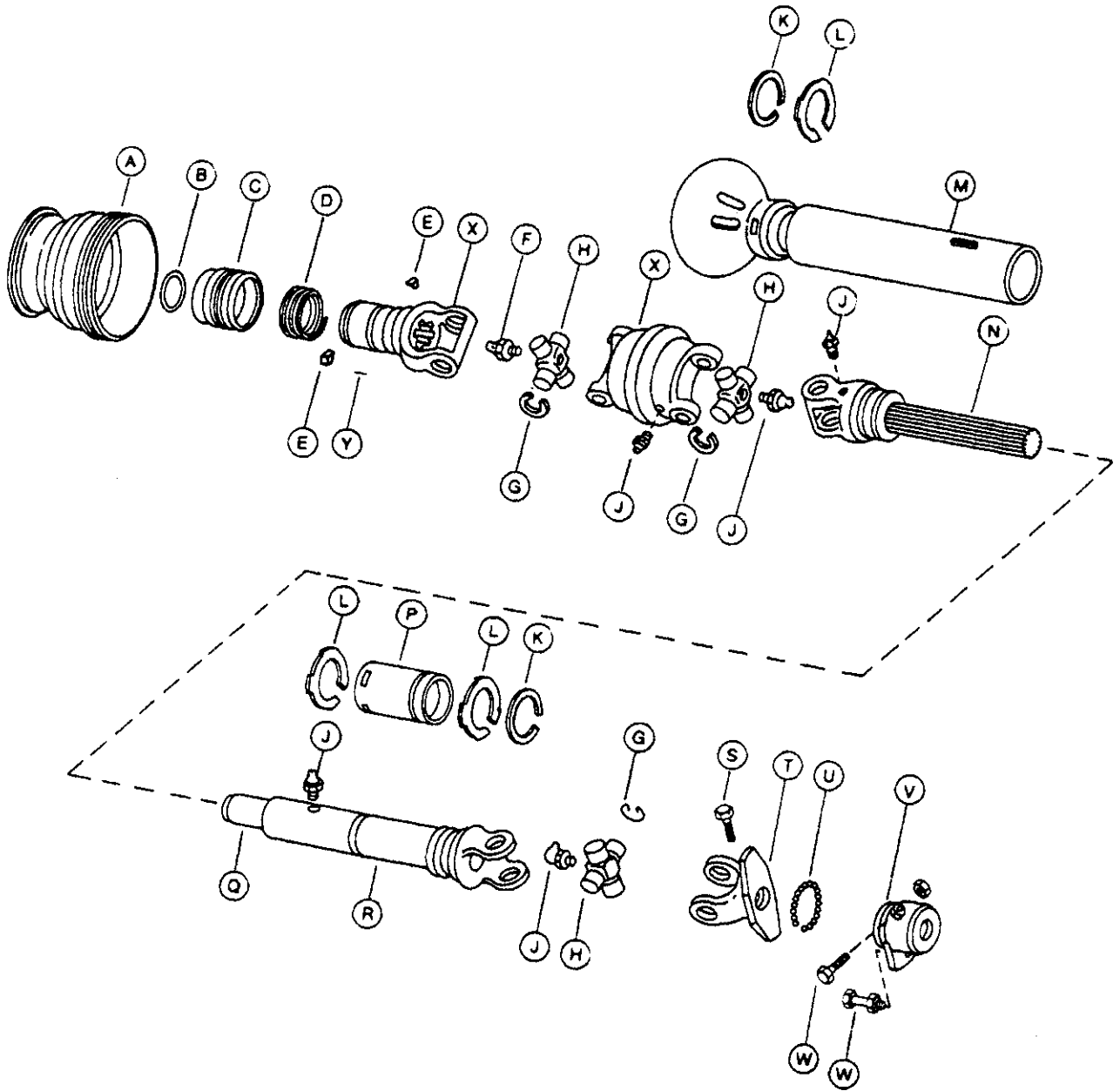

A—PTO Shield
 B—Snap Ring
 C—Sleeve
 D—Springs
 E—Pawls
 F—Lubrication Fitting

G—Snap Ring
 H—Cross and Bearing Assembly
 J—Lubrication Fitting
 K—Guide
 L—PTO Shield Retainer

M—PTO Shaft Shield
 N—Yoke with Shaft
 P—Inner Shield
 R—Yoke with Powershaft
 S—Cap Screw
 T—Hub

U—Bearings
 V—Universal Joint Yoke
 W—Cap Screw
 X—Universal Joint
 Y—Spring Pin

20
 20
 5

E32904 -UN-12MAY89

SPECIFICATIONS

Item	Measurement	Specification
3/8-in. Socket Head Screws (Superior)	Torque	20 to 27 N·m (15 to 20 lb-ft)
Gear Case (Aluminum Case)	Capacity	0.650 L (1.4 pt)
Gear Case (Cast Iron Case)	Capacity	1.3 L (2-3/4 pt)
Input Shaft (Cast Iron Case Without Seals)	Rolling Torque	0.19 to 0.59 N·m (1.7 to 5.2 lb-in.)
Gear Case Mounting Cap Screws	Torque	84 N·m (62 lb-ft)

EX,1472,2025,A -19-06NOV95

ESSENTIAL TOOLS

NOTE: Order tools from the U.S. SERVICEGARD™ Catalog or from the European Microfiche Tool Catalog (MTC). Some tools may be available from a local supplier.

Number	Name	Use
D-05112ST	Adjustable Hook Spanner Wrench	Remove and install Comer output shaft nut.
JDST27 or JTO001	N·m (lb-in) Torque Wrench with Indicator Readout	To set rolling torque.

EX,1472,2025,B -19-11MAR93

OTHER MATERIAL

Number	Name	Use
TY6305	John Deere Cleaner-Primer	To prepare surface for gasket eliminator.
TY6304	John Deere Gasket Eliminator	Used in place of a gasket in either gear case.
PT569	John Deere NEVER-SEEZ®	Coat gear case coupler bore.

NEVER-SEEZ is a trademark of the Emhart Chemical Group

EX,1472,2025,C -19-26FEB92

20
25
1

REMOVE GEAR CASE

1. Remove two cap screws and lock nuts and remove slip clutch and driveshaft.
2. Remove two cap screws (A) from tension valve.
3. Rotate tension valve and remove four cap screws (B) securing gear case.
4. Slide gear case to the right and remove.
5. Identify the type of gear case removed:
Superior - Two piece housing, cast aluminum
Comer - One piece housing, cast iron
6. If the coupler does not slide off roll drive shaft with the gear case, remove it.

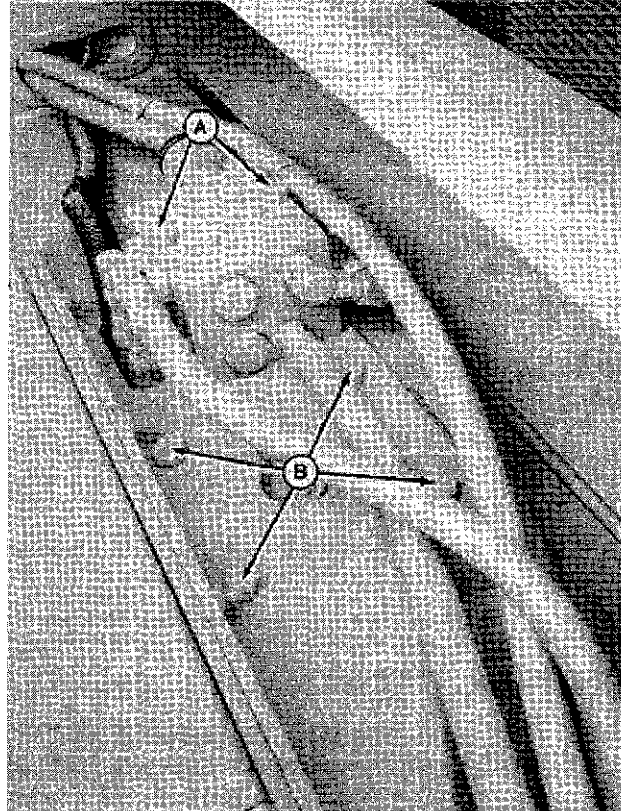

-JUN-15SEF88
E21680

EX,1472,2025,D -19-11MAR93

DISASSEMBLE SUPERIOR GEAR CASE (ALUMINUM CASE)

1. Remove drain plug (A) from gear case and drain oil.
2. Remove nine 3/8 in. socket-head bolts. Tap with plastic or wood hammer to break seal. Remove top half of gear case (B).

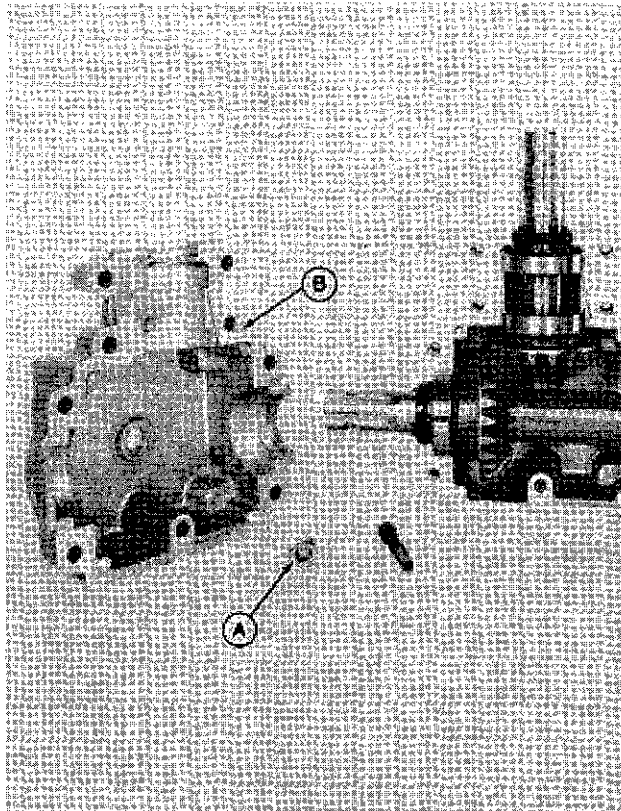

-JUN-20SEF88
E27769

EX,1472,2025,E -19-06NOV95

Gear Case Repair/Disassemble Superior Gear Case (Aluminum Case)

3. Lift both shafts out of gear case.
4. Clean both halves of gear case.
5. Remove ALL hardened gasket material.

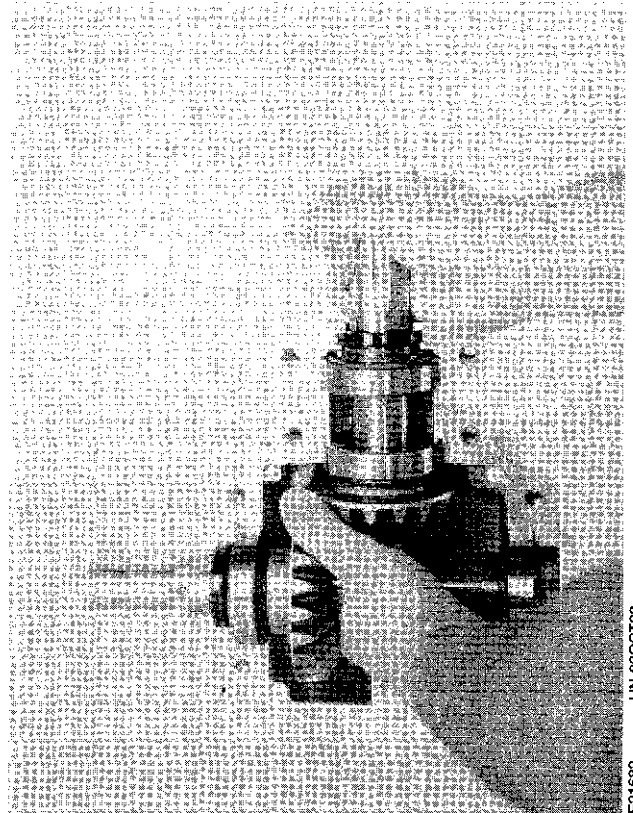

EX,1472,2025,F -19-03APR89

6. Press bearing (A) off input shaft, remove snap ring (B) and sleeve (C).

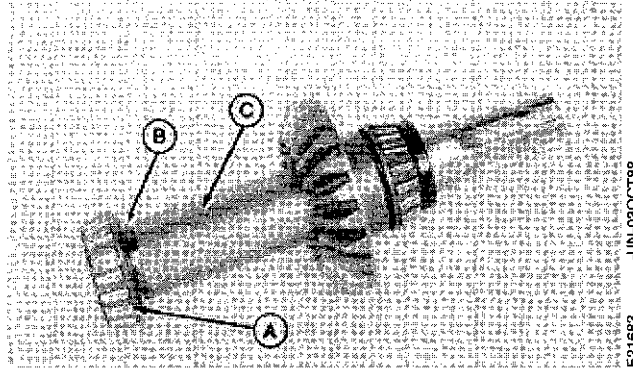

EX,1472,2025,G -19-03APR89

Gear Case Repair/Disassemble Superior Gear Case (Aluminum Case)

IMPORTANT: Do not press gear over splined area as it may scratch the shaft and reduce seal life.

7. Press 23-tooth gear (A) from input shaft.

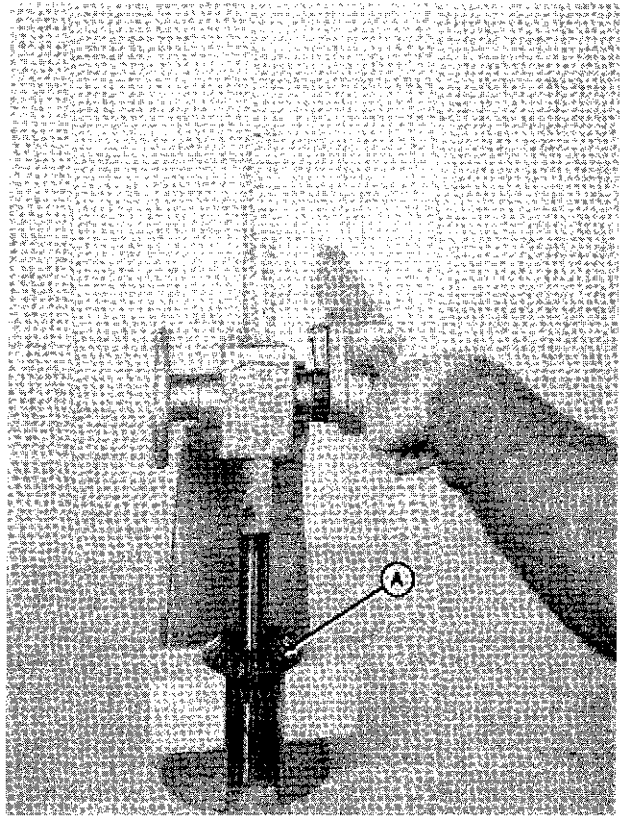

-JUN-03OCT88
E21684

EX,1472,2025,H -19-03APR89

20
25
4

8. Press 17-tooth gear (A) from output shaft.

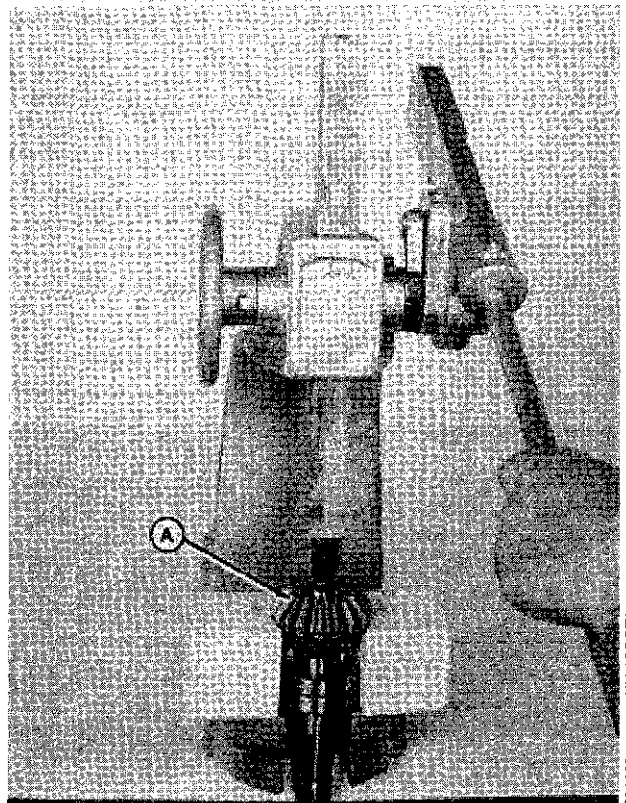

-JUN-03OCT88
E21685

EX,1472,2025,I -19-03APR89

INSPECT GEAR CASE PARTS

1. Inspect gears for chipped or broken teeth.
2. Inspect bearings for roughness. Make sure they rotate freely.
3. Inspect shafts for wear.
4. Replace seals.
5. Replace parts if needed.

EX,1472,2025,J -19-11MAR93

ASSEMBLE SUPERIOR GEAR CASE

1. Place 23-tooth gear (A) on input shaft and align keyway in gear with key in shaft.
2. Press gear in place.

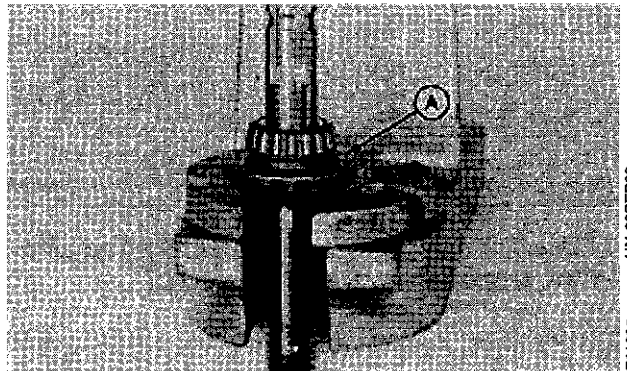

E21686
-JUN-20SEP98

EX,1472,2025,K -19-11MAR93

IMPORTANT: To prevent bearing damage, support inner race of bearing while pressing.

3. Install sleeve (A) and snap ring (B). Press to insure tightness of sleeve between shaft and gear.

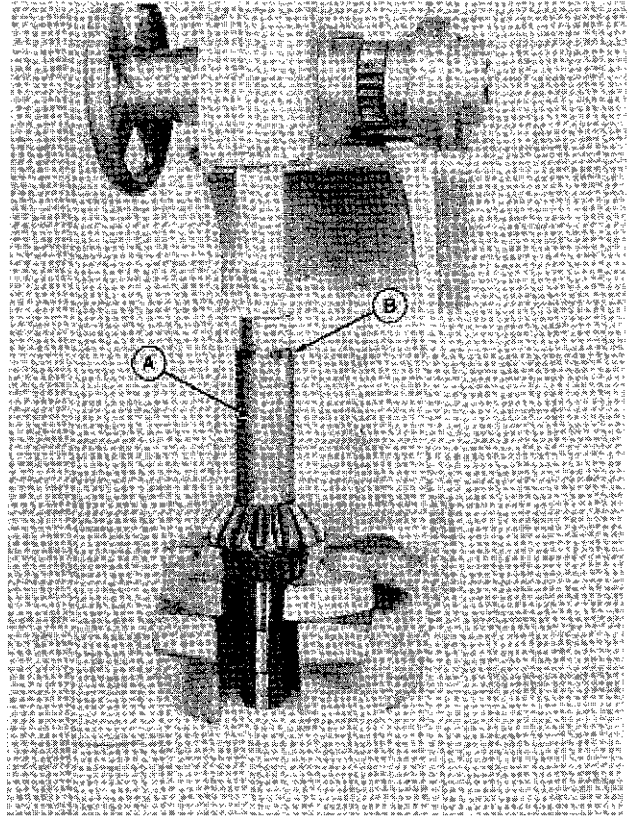

-JUN-03OCT88
E21687

EX,1472,2025,L -19-03APR89

4. Place 17-tooth gear (A) on output shaft and align keyway in gear with key in shaft.

5. Press gear on shaft and install snap ring in groove.

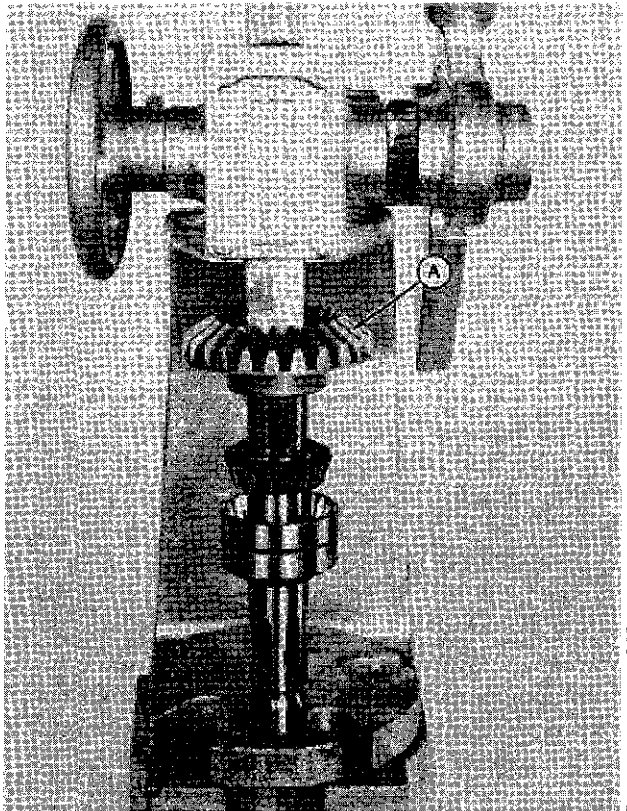

-JUN-03OCT88
E21688

EX,1472,2025,M -19-03APR89

20
25
6



Suggest:

If the above button click is invalid.

Please download this document

first, and then click the above link

to download the complete manual.

Thank you so much for reading

6. Block as shown. Press shaft (with snap ring installed) tight against 17-tooth gear (A). Gear must be tight against snap ring (B) for installation in gear case.

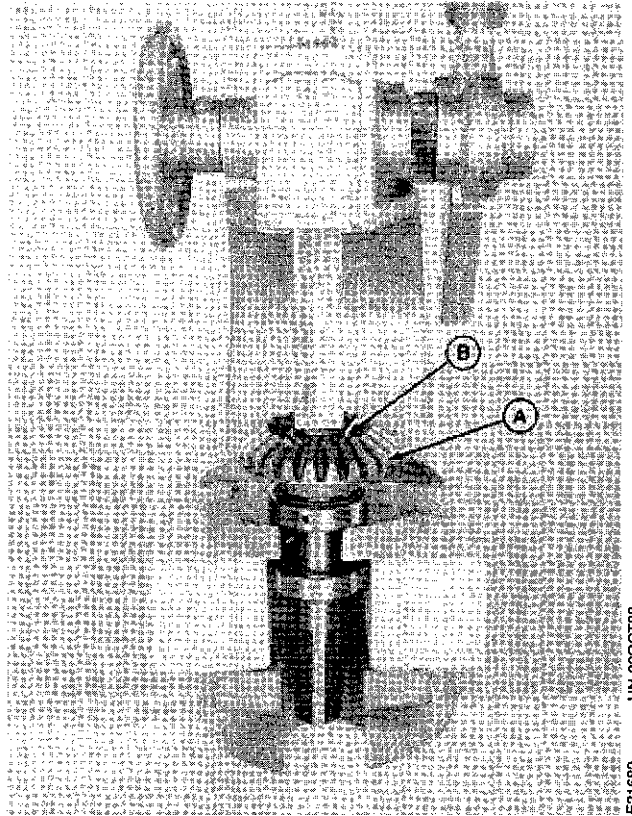

20
25
7

-UN-03OCT88
E2 1689

EX,1472,2025,N -19-03APR89

7. Spray both mating surfaces of gear case with John Deere Cleaner-Primer and wipe dry.

8. Spray top half of case with John Deere Cleaner-Primer and let air dry approximately 1 minute.

9. Install shafts in lower case half.

10. Lay 2 mm (1/16 in.) bead (A) of John Deere Gasket Eliminator around lower case casting as shown.

11. Place top half of case over lower half and press down with hand. Take care not to disturb seals.

12. Install nine 3/8 in. socket-head screws and tighten to 20-27 N·m (15-20 lb·ft).

13. Fill gear case with 0.650 L (1.4 pt) SAE 85-140 GL-5 gear lubricant.

- A—2 mm (1/16 in. Bead)
- B—23 Tooth Gear
- C—17 Tooth Gear

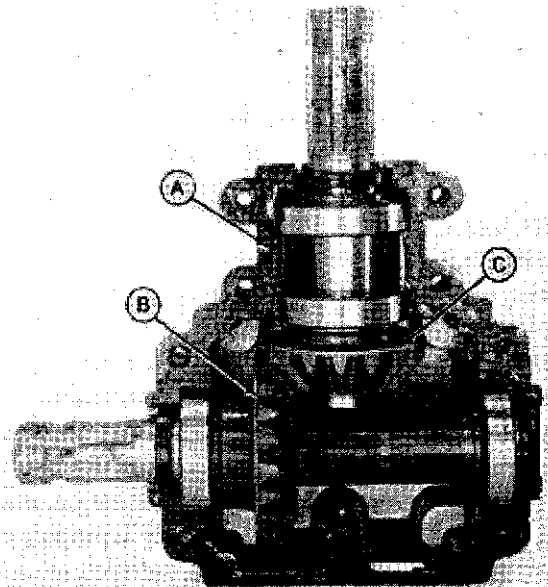

-UN-24AUG89
E33510

EX,1472,2025,O -19-06NOV95

<https://www.ebooklibonline.com>

Hello dear friend!

Thank you very much for reading.

Enter the link into your browser.

The full manual is available for immediate download.

<https://www.ebooklibonline.com>