

# **322, 330, 332 and 430 Lawn and Garden Tractors**

**For complete service information also see:**

**Yanmar Gasoline Engines . . . . . CTM12  
John Deere Series 220 Diesel Engines . . . CTM3**

**John Deere Horicon Works  
TM1591 (15JUL95)**

LITHO IN U.S.A.  
ENGLISH

# Introduction

## FOREWORD

This manual is written for an experienced technician. Essential tools required in performing certain service work are identified in this manual and are recommended for use.

Live with safety: Read the safety messages in the introduction of this manual and the cautions presented throughout the text of the manual.

**N** This is the safety-alert symbol. When you see this symbol on the machine or in this manual, be alert to the potential for personal injury.

Technical manuals are divided in two parts: repair and diagnostics. Repair sections tell how to repair the components. Diagnostic sections help you identify the majority of routine failures quickly.

Information is organized in groups for the various components requiring service instruction. At the beginning of each group are summary listings of all applicable essential tools, other materials needed to do the job and service parts kits.

Section 10, Group 15—Repair Specifications, consist of all applicable specifications, near tolerances and specific torque values for various components on each individual machine.

Section 10, Group 20—Test and Adjustment Specifications, consist of all applicable test and adjustment specifications for various systems for each individual machine.

Binders, binder labels, and tab sets can be ordered by John Deere dealers direct from the John Deere Distribution Service Center.

This manual is part of a total product support program.

FOS MANUALS—REFERENCE

TECHNICAL MANUALS—MACHINE SERVICE

COMPONENT MANUALS—COMPONENT SERVICE

Fundamentals of Service (FOS) Manuals cover basic theory of operation, fundamentals of troubleshooting, general maintenance, and basic type of failures and their causes. FOS Manuals are for training new personnel and for reference by experienced technicians.

Technical Manuals are concise guides for specific machines. Technical manuals are on-the-job guides containing only the vital information needed for diagnosis, analysis, testing, and repair.

Component Technical Manuals are concise service guides for specific components. Component technical manuals are written as stand-alone manuals covering multiple machine applications.

# Contents

## SECTION 10—GENERAL INFORMATION

- Group 05—Safety
- Group 10—General Specifications
- Group 15—Repair Specifications
- Group 20—Test and Adjustment Specifications
- Group 25—Fuels and Lubricants
- Group 30—Serial Number Locations

## SECTION 20—ENGINE REPAIR

- Group 05—Engine—322
- Group 06—Engine—330, 332 and 430

## SECTION 40—ELECTRICAL REPAIR

- Group 05—Front PTO Clutch

## SECTION 50—POWER TRAIN REPAIR

- Group 05—Transmission
- Group 10—Transmission Control Linkage
- Group 15—Differential
- Group 20—Rear Axles
- Group 25—Drive Shaft—322, 330 and 332
- Group 26—Drive Shaft—430

## SECTION 60—STEERING AND BRAKE REPAIR

- Group 05—Steering—330
- Group 06—Steering—322, 332 and 430
- Group 10—Brakes

## SECTION 70—HYDRAULIC REPAIR

- Group 05—Hydraulic Control Valve

## SECTION 80—MISCELLANEOUS REPAIR

- Group 05—Front Axle
- Group 10—Mower Spindle and Jack Sheave Repair
- Group 15—Mower Gear Case Repair

## SECTION 220—ENGINE, FUEL AND AIR SYSTEM CHECKOUT AND DIAGNOSIS

- Group 05—Engine, Fuel and Air System Checkout

- Group 10—Diagnosis, Tests and Adjustments—322
- Group 11—Diagnosis, Tests and Adjustments—330, 332 and 430

## SECTION 240—ELECTRICAL SYSTEM CHECKOUT, OPERATION AND DIAGNOSIS

- Group 05—Electrical System Checkout
- Group 10—Electrical Schematics
- Group 15—Component Location and Operation
- Group 20—Electrical System Diagnosis
- Group 25—Electrical System Component Tests and Adjustments

## SECTION 250—POWER TRAIN CHECKOUT, OPERATION AND DIAGNOSIS

- Group 05—Power Train Checkout
- Group 10—Theory of Operation
- Group 15—Diagnosis, Tests and Adjustments

## SECTION 260—STEERING AND BRAKES CHECKOUT, OPERATION AND DIAGNOSIS

- Group 05—Steering And Brakes System Checkout
- Group 10—Theory of Operation
- Group 15—Diagnosis, Tests and Adjustments

## SECTION 270—HYDRAULIC SYSTEM CHECKOUT, OPERATION AND DIAGNOSIS

- Group 05—Hydraulic System Checkout
- Group 10—Hydraulic Schematics
- Group 15—Theory of Operation
- Group 20—Diagnosis, Tests and Adjustments

## SECTION 299—DEALER FABRICATED TOOLS

- Group 00—Dealer Fabricated Tools

## Index

*All information, illustrations and specifications in this manual are based on the latest information available at the time of publication. The right is reserved to make changes at any time without notice.*

TM1591-19-15JUL95

COPYRIGHT© 1995  
DEERE & COMPANY  
Moline, Illinois  
All rights reserved  
A John Deere ILLUSTRATION™ Manual

**<https://www.ebooklibonline.com>**

Hello dear friend!

Thank you very much for reading.

Enter the link into your browser.

The full manual is available for immediate download.

**<https://www.ebooklibonline.com>**

# Dealer Presentation Sheet

## JOHN DEERE DEALERS

**IMPORTANT: Please remove this page and route through your service department.**

This is a complete revision for models 322, 330, 332 and 430 found in TM1277, TM1309 and TM1345. The complete revision of remaining machines (316, 318 and 420) can be found in TM1590. AFTER receiving both TM1590 and TM1591, please discard old TM1277 dated December 1987, TM1309 dated July 1985 and TM1345 dated June 1986.

*NOTE: There are several "versions" of each model tractor. All versions were not available at time of latest printing. Some versions may not be covered.*

# Section 10

# GENERAL INFORMATION

## Contents

Page

**Group 05—Safety** . . . . . 10-05-1

**Group 10—General Specifications**

Machine Specifications

322 and 330 . . . . . 10-10-1

332 and 430 . . . . . 10-10-4

**Group 15—Repair Specifications**

Repair Specifications . . . . . 10-15-1

Metric Series Torque Chart . . . . . 10-15-4

Inch Series Torque Chart . . . . . 10-15-5

Metric Torque Values—Grade 7 . . . . . 10-15-6

Set Screw Torque Chart . . . . . 10-15-6

Service Recommendations

Flat Face O-Ring Seal Fittings . . . . . 10-15-8

Tube and Hose Fitting, 37° Flare and  
30° Cone Seat Connectors . . . . . 10-15-9

**Group 20—Test and Adjustment  
Specifications** . . . . . 10-20-1

**Group 25—Fuels and Lubricants**

Fuel—322 . . . . . 10-25-1

Diesel Fuel—330, 332 and 430 . . . . . 10-25-2

Storing Fuel . . . . . 10-25-3

Do Not Use Galvanized Containers . . . . . 10-25-3

Engine Oil—322 . . . . . 10-25-4

Diesel Engine Oil—330, 332 and 430 . . . . . 10-25-5

Engine Coolant . . . . . 10-25-6

Liquid Coolant Conditioner . . . . . 10-25-6

Transmission and Hydraulic Oil . . . . . 10-25-7

Grease . . . . . 10-25-8

Mower Deck Gear Case Oil . . . . . 10-25-8

Alternative and Synthetic Lubricants . . . . . 10-25-9

Lubricant Storage . . . . . 10-25-9

Mixing of Lubricants . . . . . 10-25-9

**Group 30—Serial Number Locations**

Serial Numbers

Product Identification . . . . . 10-30-1

Engine . . . . . 10-30-1

Transmission . . . . . 10-30-1

Differential . . . . . 10-30-2

Control Valve . . . . . 10-30-2

## RECOGNIZE SAFETY INFORMATION

This is the safety-alert symbol. When you see this symbol on your machine or in this manual, be alert to the potential for personal injury.

Follow recommended precautions and safe operating practices.

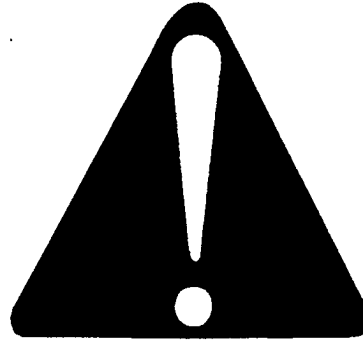

DX,ALERT -19-03MAR93

10  
05  
1  
-UN-07DEC88  
T81389

## UNDERSTAND SIGNAL WORDS

A signal word—DANGER, WARNING, or CAUTION—is used with the safety-alert symbol. DANGER identifies the most serious hazards.

DANGER or WARNING safety signs are located near specific hazards. General precautions are listed on CAUTION safety signs. CAUTION also calls attention to safety messages in this manual.



DX,SIGNAL -19-03MAR93

-19-30SEP88  
TS187

## FOLLOW SAFETY INSTRUCTIONS

Carefully read all safety messages in this manual and on your machine safety signs. Keep safety signs in good condition. Replace missing or damaged safety signs. Be sure new equipment components and repair parts include the current safety signs. Replacement safety signs are available from your John Deere dealer.

Learn how to operate the machine and how to use controls properly. Do not let anyone operate without instruction.

Keep your machine in proper working condition. Unauthorized modifications to the machine may impair the function and/or safety and affect machine life.

If you do not understand any part of this manual and need assistance, contact your John Deere dealer.



DX,READ -19-03MAR93

-UN-23AUG88  
TS201

10  
05  
2

## HANDLE FLUIDS SAFELY—AVOID FIRES

When you work around fuel, do not smoke or work near heaters or other fire hazards.

Store flammable fluids away from fire hazards. Do not incinerate or puncture pressurized containers.

Make sure machine is clean of trash, grease, and debris.

Do not store oily rags; they can ignite and burn spontaneously.



DX,FLAME -19-04JUN90

-UN-23AUG88  
TS227

## PREVENT BATTERY EXPLOSIONS

Keep sparks, lighted matches, and open flame away from the top of battery. Battery gas can explode.

Never check battery charge by placing a metal object across the posts. Use a volt-meter or hydrometer.

Do not charge a frozen battery; it may explode. Warm battery to 16°C (60°F).



DX,SPARKS -19-03MAR93

-UN-23AUG88  
TS204

## PREPARE FOR EMERGENCIES

Be prepared if a fire starts.

Keep a first aid kit and fire extinguisher handy.

Keep emergency numbers for doctors, ambulance service, hospital, and fire department near your telephone.

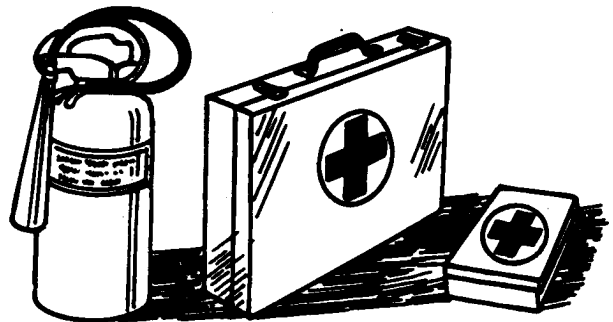

DX,FIRE2 -19-03MAR93

-UN-23AUG88  
TS291

## PREVENT ACID BURNS

Sulfuric acid in battery electrolyte is poisonous. It is strong enough to burn skin, eat holes in clothing, and cause blindness if splashed into eyes.

Avoid the hazard by:

1. Filling batteries in a well-ventilated area.
2. Wearing eye protection and rubber gloves.
3. Avoiding breathing fumes when electrolyte is added.
4. Avoiding spilling or dripping electrolyte.
5. Use proper jump start procedure.

If you spill acid on yourself:

1. Flush your skin with water.
2. Apply baking soda or lime to help neutralize the acid.
3. Flush your eyes with water for 15—30 minutes. Get medical attention immediately.

If acid is swallowed:

1. Do not induce vomiting.
2. Drink large amounts of water or milk, but do not exceed 2 L (2 quarts).
3. Get medical attention immediately.

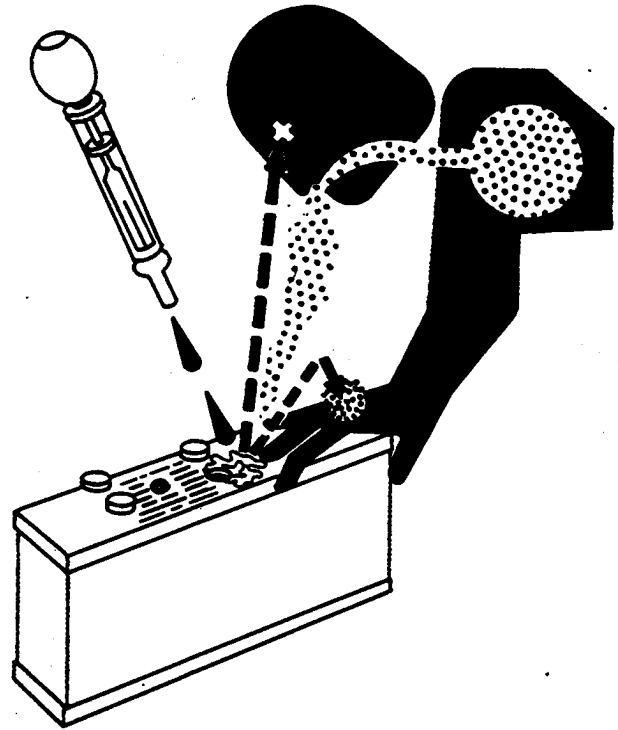

DX,POISON -19-21APR93

103951  
-UN-23AUG88  
T5203

## SERVICE COOLING SYSTEM SAFELY

Explosive release of fluids from pressurized cooling system can cause serious burns.

Shut off engine. Only remove filler cap when cool enough to touch with bare hands. Slowly loosen cap to first stop to relieve pressure before removing completely.



DX,RCAP -19-04JUN90

T5281  
-UN-23AUG88

## HANDLE CHEMICAL PRODUCTS SAFELY

Direct exposure to hazardous chemicals can cause serious injury. Potentially hazardous chemicals used with John Deere equipment include such items as lubricants, coolants, paints, and adhesives.

A Material Safety Data Sheet (MSDS) provides specific details on chemical products: physical and health hazards, safety procedures, and emergency response techniques.

Check the MSDS before you start any job using a hazardous chemical. That way you will know exactly what the risks are and how to do the job safely. Then follow procedures and recommended equipment.

(See your John Deere dealer for MSDS's on chemical products used with John Deere equipment.)



DX,MSDS,NA -19-03MAR93

TS1132 -UN-26NOV90

## AVOID HIGH-PRESSURE FLUIDS

Escaping fluid under pressure can penetrate the skin causing serious injury.

Avoid the hazard by relieving pressure before disconnecting hydraulic or other lines. Tighten all connections before applying pressure.

Search for leaks with a piece of cardboard. Protect hands and body from high pressure fluids.

If an accident occurs, see a doctor immediately. Any fluid injected into the skin must be surgically removed within a few hours or gangrene may result. Doctors unfamiliar with this type of injury should reference a knowledgeable medical source. Such information is available from Deere & Company Medical Department in Moline, Illinois, U.S.A.

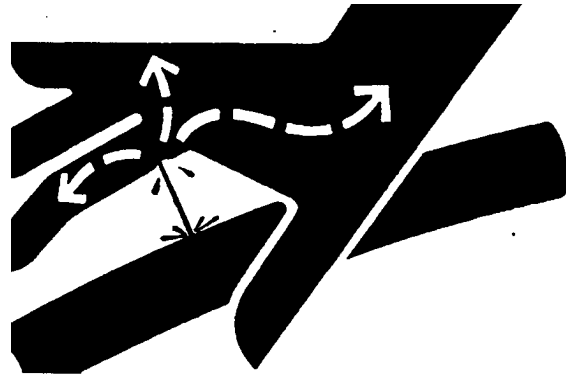

DX,FLUID -19-03MAR93

X9811 -UN-23AUG88

## PREPARE MACHINE FOR REPAIR

1. Move hydrostatic control lever to STOP position.
2. Disengage PTO's
3. Lower all equipment to the ground.
4. Engage park brake.
5. Stop the engine and remove the key.
6. Operate all hydraulic control levers to release hydraulic pressure in the system.

Before you leave the operator's seat, wait for engine and attachment parts to stop moving.

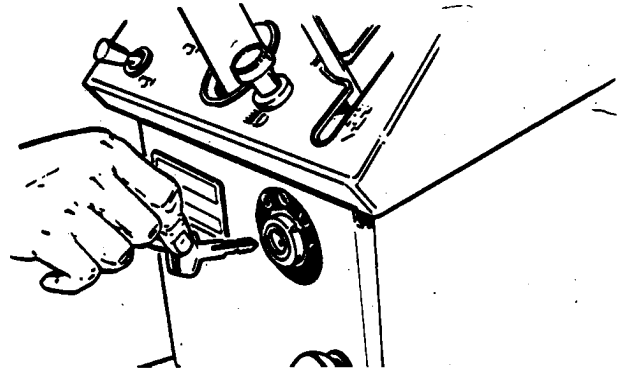

MX,1005R,8 -19-01APR86

5191  
-UN-24APR89  
M34228

## SUPPORT MACHINE PROPERLY

Always lower the attachment or implement to the ground before you work on the machine. If you must work on a lifted machine or attachment, securely support the machine or attachment.

Do not support the machine on cinder blocks, hollow tiles, or props that may crumble under continuous load. Do not work under a machine that is supported solely by a jack. Follow recommended procedures in this manual.

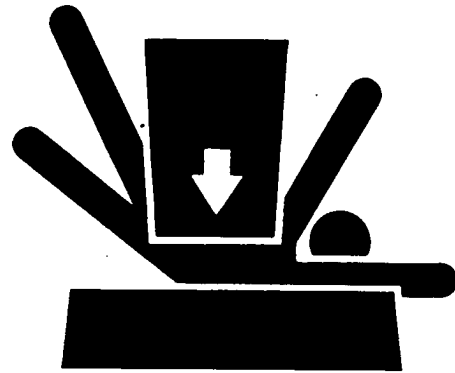

DX,LOWER -19-04JUN90

-UN-23AUG88  
TS229

### WEAR PROTECTIVE CLOTHING

Wear close fitting clothing and safety equipment appropriate to the job.

Prolonged exposure to loud noise can cause impairment or loss of hearing.

Wear a suitable hearing protective device such as earmuffs or earplugs to protect against objectionable or uncomfortable loud noises.

Operating equipment safely requires the full attention of the operator. Do not wear radio or music headphones while operating machine.

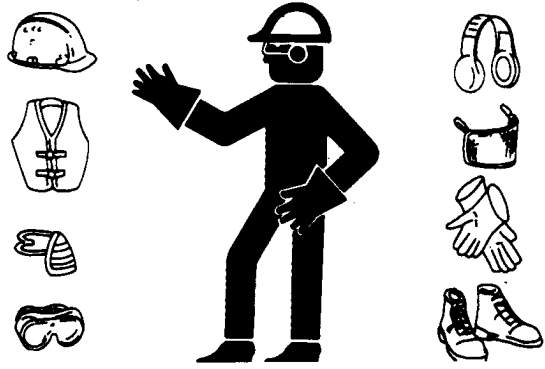

DX,WEAR -19-10SEP90

TS206 -UN-23AUG88

### WORK IN CLEAN AREA

Before starting a job:

- Clean work area and machine.
- Make sure you have all necessary tools to do your job.
- Have the right parts on hand.
- Read all instructions thoroughly; do not attempt shortcuts.

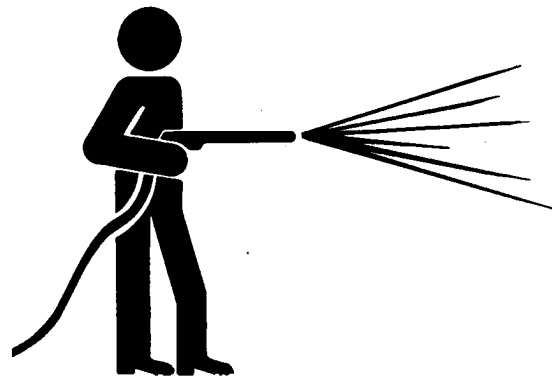

DX,CLEAN -19-04JUN90

T6642EJ -UN-18OCT88

### SERVICE MACHINES SAFELY

Tie long hair behind your head. Do not wear a necktie, scarf, loose clothing, or necklace when you work near machine tools or moving parts. If these items were to get caught, severe injury could result.

Remove rings and other jewelry to prevent electrical shorts and entanglement in moving parts.

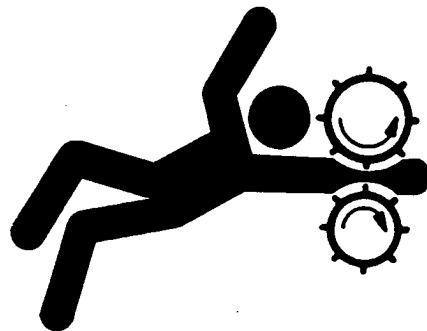

DX,LOOSE -19-04JUN90

TS228 -UN-23AUG88

### WORK IN VENTILATED AREA

Engine exhaust fumes can cause sickness or death. If it is necessary to run an engine in an enclosed area, remove the exhaust fumes from the area with an exhaust pipe extension.

If you do not have an exhaust pipe extension, open the doors and get outside air into the area.

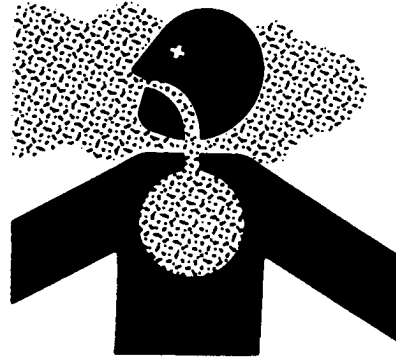

DX,AIR -19-04JUN90

TS220 -UN-23AUG88

### ILLUMINATE WORK AREA SAFELY

Illuminate your work area adequately but safely. Use a portable safety light for working inside or under the machine. Make sure the bulb is enclosed by a wire cage. The hot filament of an accidentally broken bulb can ignite spilled fuel or oil.

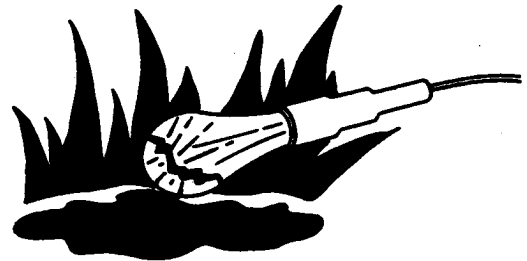

DX,LIGHT -19-04JUN90

TS223 -UN-23AUG88

### REPLACE SAFETY SIGNS

Replace missing or damaged safety signs. See the machine operator's manual for correct safety sign placement.

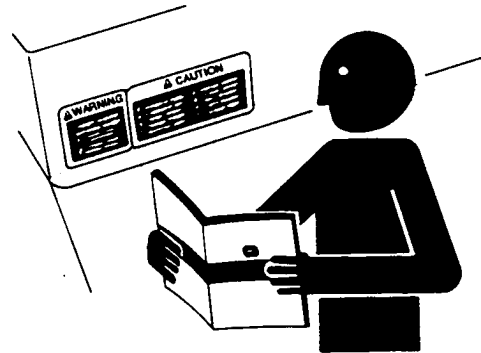

DX,SIGNS1 -19-04JUN90

TS201 -UN-23AUG88

### USE PROPER LIFTING EQUIPMENT

Lifting heavy components incorrectly can cause severe injury or machine damage.

Follow recommended procedure for removal and installation of components in the manual.

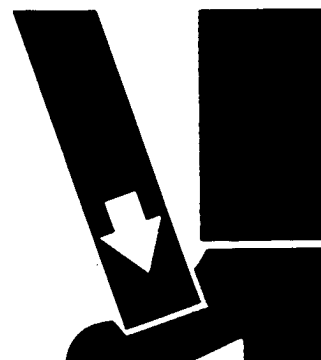

DX,LIFT -19-04JUN90

TS226 -UN-23AUG88

10  
05  
8

## REMOVE PAINT BEFORE WELDING OR HEATING

Avoid potentially toxic fumes and dust.

Hazardous fumes can be generated when paint is heated by welding, soldering, or using a torch.

Do all work outside or in a well ventilated area. Dispose of paint and solvent properly.

Remove paint before welding or heating:

- If you sand or grind paint, avoid breathing the dust. Wear an approved respirator.
- If you use solvent or paint stripper, remove stripper with soap and water before welding. Remove solvent or paint stripper containers and other flammable material from area. Allow fumes to disperse at least 15 minutes before welding or heating.

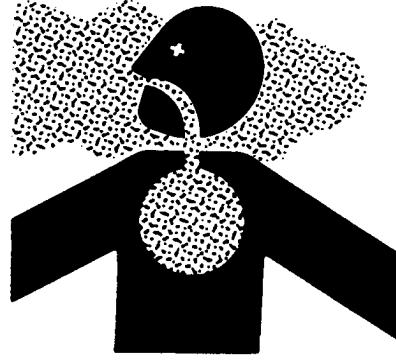

TS220 -UN-23AUG88

DX,PAINT -19-03MAR93

## AVOID HEATING NEAR PRESSURIZED FLUID LINES

Flammable spray can be generated by heating near pressurized fluid lines, resulting in severe burns to yourself and bystanders. Do not heat by welding, soldering, or using a torch near pressurized fluid lines or other flammable materials. Pressurized lines can be accidentally cut when heat goes beyond the immediate flame area.



TS953 -UN-15MAY90

DX,TORCH -19-03MAR93

## SERVICE TIRES SAFELY

Explosive separation of a tire and rim parts can cause serious injury or death.

Do not attempt to mount a tire unless you have the proper equipment and experience to perform the job.

Always maintain the correct tire pressure. Do not inflate the tires above the recommended pressure. Never weld or heat a wheel and tire assembly. The heat can cause an increase in air pressure resulting in a tire explosion. Welding can structurally weaken or deform the wheel.

When inflating tires, use a clip-on chuck and extension hose long enough to allow you to stand to one side and NOT in front of or over the tire assembly. Use a safety cage if available.

Check wheels for low pressure, cuts, bubbles, damaged rims or missing lug bolts and nuts.



DX,TIRECP -19-24AUG90

9510  
-UN-12APR90  
TS952

## AVOID HARMFUL ASBESTOS DUST

Avoid breathing dust that may be generated when handling components containing asbestos fibers. Inhaled asbestos fibers may cause lung cancer.

Components in products that may contain asbestos fibers are brake pads, brake band and lining assemblies, clutch plates, and some gaskets. The asbestos used in these components is usually found in a resin or sealed in some way. Normal handling is not hazardous as long as airborne dust containing asbestos is not generated.

Avoid creating dust. Never use compressed air for cleaning. Avoid brushing or grinding material containing asbestos. When servicing, wear an approved respirator. A special vacuum cleaner is recommended to clean asbestos. If not available, apply a mist of oil or water on the material containing asbestos.

Keep bystanders away from the area.

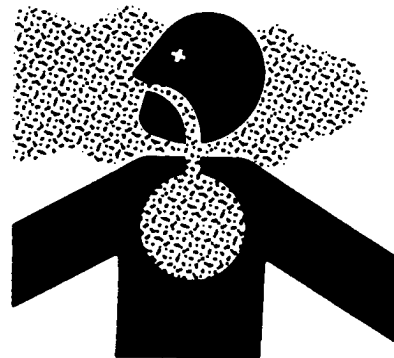

DX,DUST -19-15MAR91

-UN-23AUG88  
TS220

### PRACTICE SAFE MAINTENANCE

Understand service procedure before doing work. Keep area clean and dry.

Never lubricate, service, or adjust machine while it is moving. Keep hands, feet, and clothing from power-driven parts. Disengage all power and operate controls to relieve pressure. Lower equipment to the ground. Stop the engine. Remove the key. Allow machine to cool.

Securely support any machine elements that must be raised for service work.

Keep all parts in good condition and properly installed. Fix damage immediately. Replace worn or broken parts. Remove any buildup of grease, oil, or debris.

Disconnect battery ground cable (-) before making adjustments on electrical systems or welding on machine.



DX,SERV -19-03MAR93

TS218 -UN-23AUG88

### USE PROPER TOOLS

Use tools appropriate to the work. Makeshift tools and procedures can create safety hazards.

Use power tools only to loosen threaded parts and fasteners.

For loosening and tightening hardware, use the correct size tools. DO NOT use U.S. measurement tools on metric fasteners. Avoid bodily injury caused by slipping wrenches.

Use only service parts meeting John Deere specifications.



DX,REPAIR -19-04JUN90

TS779 -UN-08NOV89

## DISPOSE OF WASTE PROPERLY

Improperly disposing of waste can threaten the environment and ecology. Potentially harmful waste used with John Deere equipment include such items as oil, fuel, coolant, brake fluid, filters, and batteries.

Use leakproof containers when draining fluids. Do not use food or beverage containers that may mislead someone into drinking from them.

Do not pour waste onto the ground, down a drain, or into any water source.

Air conditioning refrigerants escaping into the air can damage the Earth's atmosphere. Government regulations may require a certified air conditioning service center to recover and recycle used air conditioning refrigerants.

Inquire on the proper way to recycle or dispose of waste from your local environmental or recycling center, or from your John Deere dealer.

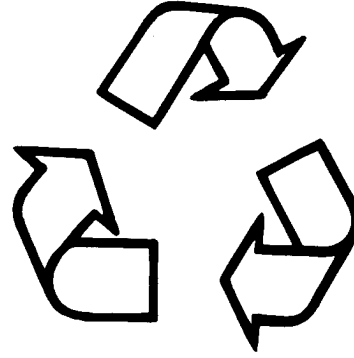

DX,DRAIN -19-03MAR93

10-05-11  
-JUN-26NOV90  
TS1133

## LIVE WITH SAFETY

Before returning machine to customer, make sure machine is functioning properly, especially the safety systems. Install all guards and shields.



DX,LIVE -19-25SEP92

-19-07OCT88  
TS231

**MACHINE SPECIFICATIONS—322 AND 330**

	322	330
<b>ENGINE</b>		
Manufacturer	Yanmar	Yanmar
Model Number	3TG66UJ	3TN66UJ
Horsepower (SAEJ1349)	13.4 kW (18 hp)	12 kW (16 hp)
Torque	4.2 kg m (30.3 ft lbs)	4.2 kg m (30.3 ft lbs)
<b>Engine Rated Speeds</b>		
Fast Idle (No Load)	3500 rpm	3450 rpm
Low Idle (No Load)	1300 rpm	1300 rpm
Number of Cylinders	3	3
Crankshaft Alignment	Horizontal	Horizontal
Stroke/Cycle	4 Cycle	4 Cycle
Bore	66 mm (2.6 in.)	66 mm (2.6 in.)
Stroke	64.2 mm (2.5 in.)	64.2 mm (2.5 in.)
Displacement	658 cm <sup>3</sup> (40.1 cu in.)	658 cm <sup>3</sup> (40.1 cu in.)
Compression Ratio	8.7:1	22.4:1
Cooling	Liquid	Liquid
Coolant Capacity	2.8 L (3 U.S. qt)	2.8 L (3 U.S. qt)
Air Filter Type	Dry with Primary and Secondary Elements	Dry with Primary and Secondary Elements
Lubrication System	Full Pressure w/Filter	Full Pressure w/Filter
Crankcase Capacity (w/o Filter)	2.5 L (2.6 U.S. qt)	2.5 L (2.6 U.S. qt)
Oil Filter	Replaceable	Replaceable
Spark Plugs	NGK BPR4BS Champion RN11YC	N/A
<b>FUEL SYSTEM</b>		
Fuel Tank Location	Rear	Rear
Fuel Gauge	Standard	Standard
Fuel Tank Capacity	17 L (4.5 U.S. gal)	17 L (4.5 U.S. gal)
Fuel	85 Octane Unleaded	No.1 or No.2 Diesel
Fuel Pump Location	Frame	Frame
Fuel Pump Type	Electric	Electric
Fuel Delivery	Fixed Jet Carburetor	Indirect Injection
Injection Pump Type	N/A	In-Line Multi-Plunger
Fuel Shutoff	Electric Solenoid	Manual
<b>ELECTRICAL SYSTEM</b>		
Ignition	Electronic	N/A
Type of Starter	12 Volts, Solenoid	12 Volts, Solenoid
Charging System	Remote Alt. 20 amp	Remote Alt. 20 amp
Battery Type	BCI Group, U1	BCI Group, U1
Battery Voltage	12V	12V
Battery Reserve Capacity @25 amp	44 minutes	44 minutes
<b>Battery</b>		
Cold Cranking amp @0°F	342 amp	342 amp
Headlights	Standard	Standard
Reflector/Tail Lights	Standard	Standard
Dash Indicator Lights	Standard	Standard
Operator Presence System	Standard	Standard
Hourmeter	Standard	Standard

Continued on next page.

MX,15911010,1 -19-13JUL95

General Specifications/Machine Specifications

10  
10  
2

	322	330
<b>POWER TRAIN</b>		
Transmission Type . . . . .	Hydrostatic . . . . .	Hydrostatic
Number of Speeds . . . . .	Infinite . . . . .	Infinite
<b>Travel Speeds</b>		
Forward . . . . .	0—12.38 km/h . . . . . (0—7.69 mph)	0—12.38 km/h (0—7.69 mph)
Reverse . . . . .	0—6.19 km/h . . . . . (0—3.85 mph)	0—6.19 km/h (0—3.85 mph)
Transmission Capacity (w/Filter) . . . . .	6.1 L (13 U.S. pt) . . . . .	6.1 L (13 U.S. pt)
Trans. Oil Cooler . . . . .	Optional . . . . .	N/A
Trans. Oil Filter . . . . .	Standard . . . . .	Standard
Differential Lock . . . . .	N/A . . . . .	N/A
<b>STEERING</b>		
Type . . . . .	Power, Hydrostatic . . . . .	Manual
<b>BRAKES</b>		
Location . . . . .	Rear Wheels . . . . .	Rear Wheels
Individual Control . . . . .	Standard . . . . .	N/A
Type . . . . .	Shoe and Drum . . . . .	Shoe and Drum
Return-to-Neutral Braking . . . . .	Standard . . . . .	Standard
Parking . . . . .	Yes . . . . .	Yes
<b>HYRAULIC SYSTEM</b>		
Type . . . . .	Two-Function . . . . . (One w/Float)	Single-Function
Hydraulic Couplers . . . . .	Two Sets . . . . .	One Set
<b>PTO</b>		
Front . . . . .	Standard . . . . .	Standard
Rear . . . . .	Optional . . . . .	Optional
Type . . . . .	Electric Clutch . . . . .	Electric Clutch
Control . . . . .	Elec. Switch on Dash . . . . .	Elec. Switch on Dash
<b>PTO rpm (No Load)</b>		
Front . . . . .	3500 . . . . .	3450
Rear . . . . .	2000 . . . . .	2000
<b>MOWER ATTACHMENT</b>		
Compatibility . . . . .	38, 46 and 50 Inch . . . . .	38, 46 and 50 Inch
Lift System . . . . .	Hydraulic . . . . .	Hydraulic
<b>WHEEL TREAD</b>		
Front . . . . .	813 mm (32 in.) . . . . .	813 mm (32 in.)
<b>Rear</b>		
Narrow . . . . .	775 mm (30.5 in.) . . . . .	775 mm (30.5 in.)
Wide . . . . .	834 mm (32.8 in.) . . . . .	834 mm (32.8 in.)

Continued on next page.

MX,15911010,2 -19-13JUL95

*General Specifications/Machine Specifications*

10  
10  
3

**322**

**330**

**TIRES**

**Standard Tires**

Front Turf	16 x 6.50-8, 2 PR	16 x 6.50-8, 2 PR
Rear Turf or Bar	23 x 10.50-12, 2 PR	23 x 10.50-12, 2 PR

**Optional Tires**

Front (Turf)	16 x 6.50-8, 4 PR	16 x 6.50-8, 4 PR
Rear (Turf or Bar)	23 x 8.50-12, 2 PR	23 x 8.50-12, 2 PR

**Inflation Pressure**

Front	41—110 kPa (6—16 psi)	41—110 kPa (6—16 psi)
Rear	34—69 kPa (5—10 psi)	34—69 kPa (5—10 psi)

**SEAT**

Style	High-Back	High-Back
Suspension	2 Spring	2 Spring
Adjustment	Slide Rail	Slide Rail

**DIMENSIONS**

Wheel Base	1.2 m (46 in.)	1.2 m (46 in.)
Overall Length	1.8 m (69.5 in.)	1.8 m (69.5 in.)
Overall Height	1.1 m (44.5 in.)	1.1 m (44.5 in.)
Overall Width (max.)	1.1 m (43.3 in.)	1.1 m (43.3 in.)
Overall Width (min.)	1.04 m (41 in.)	1.04 m (41 in.)
<b>Turning Radius</b>		
Inside Rear Wheel	0.66 m (26 in.)	0.66 m (26 in.)
Outside Front Wheel	2.0 m (80 in.)	2.0 m (80 in.)

**NET WEIGHT (No Fuel)** . . . . . 408 kg (900 lbs) . . . . . 408 kg (900 lbs)

**SHIPPING WEIGHT** . . . . . 445 kg (980 lbs) . . . . . 445 kg (980 lbs)

*(Specifications and design subject to change without notice.)*

MX,15911010,3 -19-13JUL95

## MACHINE SPECIFICATIONS—332 AND 430

	332	430
<b>ENGINE</b>		
Manufacturer	Yanmar	Yanmar
Model Number	3TN66UJ	3TNA72UJ
Horsepower (SAEJ1349)	12 kW (16 hp)	15 kW (20 hp)
Torque	4.2 kg m (30.3 ft lbs)	5.1 kg m (36.8 ft lbs)
<b>Engine Rated Speeds</b>		
Fast Idle (No Load)	3425 rpm	3400 rpm
Low Idle (No Load)	1400 rpm	1300 rpm
Number of Cylinders	3	3
Crankshaft Alignment	Horizontal	Horizontal
Stroke/Cycle	4 Cycle	4 Cycle
Bore	66 mm (2.6 in.)	72 mm (2.84 in.)
Stroke	64.2 mm (2.5 in.)	72 mm (2.84 in.)
Displacement	658 cm <sup>3</sup> (40.1 cu in.)	879 cm <sup>3</sup> (53.6 cu in.)
Compression Ratio	22.4:1	21.6:1
Cooling	Liquid	Liquid
Coolant Capacity	2.8 L (3 U.S. qt)	3.8 L (1 U.S. gal)
Air Filter Type	Dry with Primary and Secondary Elements	Dry with Primary and Secondary Elements
Lubrication System	Full Pressure w/Filter	Full Pressure w/Filter
Crankcase Capacity (w/o Filter)	2.5 L (2.6 U.S. qt)	2.9 L (3.1 U.S. qt)
Oil Filter	Replaceable	Replaceable
<b>FUEL SYSTEM</b>		
Fuel Tank Location	Rear	Rear
Fuel Gauge	Standard	Standard
Fuel Tank Capacity	17 L (4.5 U.S. gal)	24.6 L (6.5 U.S. gal)
Fuel	No.1 or No.2 Diesel	No.1 or No.2 Diesel
Fuel Pump Location	Frame	Frame
Fuel Pump Type	Electric	Electric
Fuel Delivery	Indirect Injection	Indirect Injection
Injection Pump Type	In-Line Multi-Plunger	In-Line Multi-Plunger
Fuel Shutoff	Electric Solenoid	Electric Solenoid
<b>ELECTRICAL SYSTEM</b>		
Ignition	N/A	N/A
Type of Starter	12 Volts, Solenoid	12 Volts, Solenoid
<b>Charging System</b>		
Early Machines	Remote Alt. 20 amp	Remote Alt. 35 amp
Later Machines	Remote Alt. 20 amp	Remote Alt. 40 amp
Battery Type	BCI Group, U1	BCI Group, 22F
Battery Voltage	12V	12V
Battery Reserve Capacity @25 amp	44 minutes	102 minutes
<b>Battery</b>		
Cold Cranking amp @0°F	342 amp	491 amp
Headlights	Standard	Standard
Reflector/Tail Lights	Standard	Standard
Dash Indicator Lights	Standard	Standard
Operator Presence System	Standard	Standard
Hourmeter	Standard	Standard

Continued on next page.

MX,15911010,4 -19-13JUL95

General Specifications/Machine Specifications

	332	430
<b>POWER TRAIN</b>		
Transmission Type	Hydrostatic	Hydrostatic, 2 Ranges
Number of Speeds	Infinite	Infinite
<b>Travel Speeds</b>		
Forward	0—12.38 km/h (0—7.69 mph)	N/A
Reverse	0—6.19 km/h (0—3.85 mph)	N/A
Forward, High	N/A	0—16.09 km/h (0—10 mph)
Forward, Low	N/A	0—9.35 km/h (0—5.80 mph)
Reverse, High	N/A	0—6.44 km/h (0—4 mph)
Reverse, Low	N/A	0—4.66 km/h (0—2.90 mph)
Transmission Capacity (w/Filter)	6.1 L (13 U.S. pt)	7.1 L (15 U.S. pt)
Trans. Oil Cooler	Optional	Standard
Trans. Oil Filter	Standard	Standard
Differential Lock	N/A	Standard
<b>STEERING</b>		
Type	Power, Hydrostatic	Power, Hydrostatic
<b>BRAKES</b>		
Location	Rear Wheels	Rear Wheels
Individual Control	Standard	Standard
Type	Shoe and Drum	Shoe and Drum
Return-to-Neutral Braking	Standard	Standard
Parking	Yes	Yes
<b>HYDRAULIC SYSTEM</b>		
Type	Two-Function (One w/Float)	Three-Function (One w/Float)
Hydraulic Couplers	Two Sets	Two Sets
<b>PTO</b>		
Front	Standard	Standard
Rear	Optional	Optional
Type	Electric Clutch	Electric Clutch
Control	Elec. Switch on Dash	Elec. Switch on Dash
<b>PTO rpm (No Load)</b>		
Front	3425	3400
Rear	2000	2000
<b>MOWER ATTACHMENT</b>		
Compatibility	38, 46 and 50 Inch	50 and 60 Inch, 260 Rotary
Lift System	Hydraulic	Hydraulic

Continued on next page.

MX,15911010,5 -19-13JUL95

10  
10  
5

General Specifications/Machine Specifications

10-10-6

332

430

WHEEL TREAD

Front	813 mm (32 in.)	914 mm (36 in.)
Rear		
Narrow	775 mm (30.5 in.)	818 mm (32 in.)
Wide	834 mm (32.8 in.)	980 mm (38.6 in.)

TIRES

Standard Tires

Front Turf	16 x 6.50-8, 2 PR	18 x 8.50-8, 4 PR
Rear Turf or Bar	23 x 10.50-12, 2 PR	26 x 12.00-12, 2 PR

Optional Tires

Front (Turf)	16 x 6.50-8, 4 PR	N/A
Rear (Turf or Bar)	23 x 8.50-12, 2 PR	N/A

Inflation Pressure

Front	41—110 kPa (6—16 psi)	41—152 kPa (6—22 psi)
Rear	34—69 kPa (5—10 psi)	34—69 kPa (5—10 psi)

SEAT

Style	High-Back/Tilt	High-Back/Tilt
Suspension	2 Spring	Deluxe Seat Suspension
Adjustment	Slide Rail	Slide Rail

DIMENSIONS

Wheel Base	1.2 m (46 in.)	1.3 m (52 in.)
Overall Length	1.8 m (69.5 in.)	2.13 m (84 in.)
Overall Height	1.1 m (44.5 in.)	1.22 m (48.5 in.)
Overall Width (max.)	1.1 m (43.3 in.)	1.31 m (51.5 in.)
Overall Width (min.)	1.04 m (41 in.)	1.14 m (45 in.)
Turning Radius		
Inside Rear Wheel	0.66 m (26 in.)	0.66 m (26 in.)
Outside Front Wheel	2.0 m (80 in.)	2.2 m (86 in.)

NET WEIGHT (No Fuel) . . . . . 408 kg (900 lbs) . . . . . 533 kg (1116 lbs)

SHIPPING WEIGHT . . . . . 445 kg (980 lbs) . . . . . 567 kg (1219 lbs)

(Specifications and design subject to change without notice.)

MX,15911010,6 -19-13JUL95

**REPAIR SPECIFICATIONS**

Item	Specifications
<b>ENGINE</b>	
For all repair specifications—Use CTM12 (322) and CTM3 (330, 332 and 430)	
Engine Mounting Cap Screw/Nut Torque . . . . .	49 N·m (36 lb-ft)
Drive Shaft to Engine Cap Screw Torque	
330 and 430 . . . . .	27 N·m (20 lb-ft)
322 and 332 . . . . .	37 N·m (27 lb-ft)
Drive Shaft Universal Joint Cap Screw Torque . . . . .	60 N·m (45 lb-ft)
PTO Belt Tension Spring Length (430) . . . . .	35 mm (1.38 in.)
Fuel/Water Separator Cap Screw Torque (430) . . . . .	20 N·m (180 lb-in.)
<b>ELECTRICAL</b>	
Front PTO Clutch-to-Crankshaft Cap Screw Torque . . . . .	47 N·m (35 lb-ft)
PTO Clutch Armature to Rotor Clearance . . . . .	0.46 mm (0.018 in.)
PTO Belt Tension Spring Length (430) . . . . .	35 mm (1.380 in.)
<b>POWER TRAIN</b>	
<b>Transmission</b>	
Charge Pump-to-Transmission Cap Screw Torque . . . . .	70 N·m (52 lb-ft)
Transmission Cover Bearing Installation Height . . . . .	3 mm (0.118 in.) above housing surface
Center Section-to-Housing Cap Screw Torque . . . . .	35 N·m (26 lb-ft)
Transmission-to-Differential Cap Screw Torque . . . . .	45 N·m (33 lb-ft)
Axle Housing-to-Frame Cap Screw Torque . . . . .	100 N·m (75 lb-ft)
Brake Rod Spring Length . . . . .	42 mm (1.650 in.)
Differential-to-Frame Support Cap Screw Torque . . . . .	61 N·m (45 lb-ft)
Swashplate Control Arm-to-Control Shaft Nut Torque . . . . .	60 N·m (44 lb-ft)
Drive Shaft Clamping Yoke-to-Transmission Pump Shaft Cap Screw Torque . . . . .	60 N·m (44 lb-ft)
<b>Differential</b>	
Case and Cover Oil Groove Depth (Minimum) . . . . .	0.25 mm (0.010 in.)
Carrier Cap Screw Torque . . . . .	53 N·m (39 lb-ft)
Cover-to-Case Cap Screw Torque . . . . .	23 N·m (204 lb-in.)
<b>Axle Housing</b>	
Differential Seal Depth . . . . .	3 mm (0.118 in.) below differential surface
Axle Housing-to-Differential Cap Screw Torque . . . . .	81 N·m (60 lb-ft)
Brake Plate-to-Axle Housing Cap Screw Torque . . . . .	68 N·m (50 lb-ft)
Axle Housing-to-Frame Cap Screw Torque . . . . .	100 N·m (75 lb-ft)
Brake Rod Spring Length . . . . .	42 mm (1.650 in.)
Brake Drum Nut Torque . . . . .	88 N·m (65 lb-ft)
Rear Wheel Cap Screw Torque . . . . .	70 N·m (52 lb-ft)
<b>Drive Shaft—322 and 332</b>	
Isolator-to-Engine Cap Screw Torque . . . . .	37 N·m (27 lb-ft)
<b>Drive Shaft Cap Screws and Lock Nut Torque</b>	
Flange-to-Isolator . . . . .	27 N·m (20 lb-ft)
Clamping Yoke-to-Transmission Pump Shaft . . . . .	60 N·m (44 lb-ft)
<b>Drive Shaft—330</b>	
Isolator-to-Engine Cap Screw Torque . . . . .	27 N·m (20 lb-ft)
<b>Drive Shaft Cap Screws and Lock Nut Torque</b>	
Flange-to-Isolator . . . . .	27 N·m (20 lb-ft)
Clamping Yoke-to-Transmission Pump Shaft . . . . .	60 N·m (44 lb-ft)

Continued on next page.

MX,15911015,1 -19-13JUL95

10  
15  
2

Item	Specifications
<b>POWER TRAIN, continued</b>	
<b>Drive Shaft—430</b>	
Flange-to-Engine Cap Screw Torque . . . . .	27 N·m (20 lb-ft)
Clamping Yoke-to-Transmission Pump Shaft Cap Screw Torque . . . . .	60 N·m (44 lb-ft)
Tube Yoke Shaft-to-Bushing Yoke Tube Lock Nut Torque . . . . .	3 N·m (25 lb-in.)
<b>STEERING AND BRAKES</b>	
<b>Steering—330</b>	
Gearbox Mounting Cap Screw Torque . . . . .	95 N·m (70 lb-ft)
Steering Wheel-to-Shaft Nut Torque . . . . .	15 N·m (133 lb-in.)
Pitman Arm Nut Torque . . . . .	224 N·m (165 lb-ft)
Preload Adjuster Maximum End Clearance . . . . .	0.05 mm (0.002 in.)
Side Cover-to-Gearbox Housing Cap Screw Torque . . . . .	40 N·m (30 lb-ft)
Worm Bearing Preload Rolling Torque . . . . .	0.60—1.0 N·m (5—8 lb-in.)
Over-Center Preload Rolling Torque . . . . .	0.50—1.20 N·m (4—10 lb-in.)
Preload Adjuster Lock Nut Torque . . . . .	34 N·m (25 lb-ft)
Steering Shaft Universal Joint-to-Worm Shaft Cap Screw Torque . . . . .	24 N·m (212 lb-in.)
<b>Steering—322, 332 and 430</b>	
Steering Wheel-to-Shaft Nut Torque . . . . .	15 N·m (133 lb-in.)
Rotor-to-Stator Maximum Allowable Clearance . . . . .	0.08 mm (0.003 in.)
Steering Tube Bushing Depth . . . . .	2.5 mm (0.100 in.) below top of tube
Commutator Cover-to-Commutator Screw Torque . . . . .	1.4 N·m (12 lb-in.)
Port Cover Nut Torque . . . . .	30 N·m (22 lb-ft)
Check Ball Plug Torque (Early Version) . . . . .	14 N·m (124 lb-in.)
Steering Cylinder Mounting Nut Torque . . . . .	163 N·m (120 lb-ft)
<b>Brakes</b>	
Brake Plate-to-Axle Housing Cap Screw Torque . . . . .	68 N·m (50 lb-ft)
Axle Housing-to-Frame Cap Screw Torque . . . . .	100 N·m (75 lb-ft)
Brake Rod Spring Length . . . . .	42 mm (1.650 in.)
Brake Drum-to-Axle Nut Torque . . . . .	88 N·m (65 lb-ft)
Rear Wheel Cap Screw Torque . . . . .	70 N·m (52 lb-ft)
<b>HYDRAULICS</b>	
<b>Single-Spool Valve</b>	
Spool Screw Torque . . . . .	4 N·m (35 lb-in.)
Spool Cap-to-Body Screw Torque . . . . .	4 N·m (35 lb-in.)
Check Valve Plug Torque . . . . .	31 N·m (23 lb-ft)
<b>Two-Spool Valve</b>	
<b>Versions One and Two</b>	
Spool Cap-to-Body Screw Torque . . . . .	31 N·m (23 lb-ft)
<b>Versions Three and Four</b>	
Spool Screw and Detent Torque . . . . .	4 N·m (35 lb-in.)
Spool Cap-to-Body Screw Torque . . . . .	4 N·m (35 lb-in.)
Check Valve Plug Torque . . . . .	31 N·m (23 lb-ft)
<b>Three-Spool Valve</b>	
Spool Screws and Detent Torque . . . . .	4 N·m (35 lb-in.)
Spool Cap-to-Body Screw Torque . . . . .	4 N·m (35 lb-in.)
Check Valve Plug Torque . . . . .	31 N·m (23 lb-ft)

Continued on next page.

MX,15911015,2 -19-13JUL95

Item	Specifications
<b>MISCELLANEOUS</b>	
<b>Front Axle</b>	
PTO Belt Tension Spring Length (430) .....	35 mm (1.380 in.)
Toe-In .....	4.8 mm (3/16 in.)
<b>Mower Blade Spindles</b>	
Driven Sheave-to-Spindle Lock Nut Torque .....	140 N·m (103 lb-ft)
Blade-to-Spindle Cap Screw Torque .....	73 N·m (54 lb-ft)
<b>Mower Blade Jack Sheave</b>	
Jack Sheave-to-Spindle Lock Nut Torque .....	140 N·m (103 lb-ft)
Blade-to-Spindle Cap Screw Torque .....	73 N·m (54 lb-ft)
<b>50-Inch Mower Gear Case</b>	
Plug Installation Depth .....	1.59 mm (0.062 in.) below gear case surface
Retainer Seal Installation Depth .....	2.54 mm (0.100 in.) below retainer surface
Retainer-to-Gear Case Cap Screw Torque .....	30 N·m (22 lb-ft)
Pillow Block Seal Installation Depth .....	2.54 mm (0.100 in.) below block surface
Pillow Block-to-Gear Case Cap Screw Torque .....	30 N·m (22 lb-ft)
<b>Early 60-Inch Mower Gear Case</b>	
Cap-to-Gear Case Cap Screw Torque .....	30 N·m (22 lb-ft)
Output Shaft Endplay .....	0.025—0.076 mm (0.001—0.003 in.)
Input Shaft Backlash .....	0.076—0.130 mm (0.003—0.005 in.)
<b>Later 60-Inch Mower Gear Case</b>	
Gear Case Seal Installation Depth .....	2.54 mm (0.100 in.) below gear case surface
Retainer-to-Gear Case Cap Screw Torque .....	30 N·m (22 lb-ft)
Pillow Block Seal Installation Depth .....	2.54 mm (0.100 in.) below block surface
Pillow Block-to-Gear Case Cap Screw Torque .....	30 N·m (22 lb-ft)
<b>260 Rotary Mower Gear Case</b>	
End Cap-to-Gear Case Cap Screw Torque .....	30 N·m (22 lb-ft)
Input Shaft Endplay .....	0.025—0.076 mm (0.001—0.003 in.)
Output Shaft Backlash .....	0.076—0.130 mm (0.003—0.005 in.)
Housing-to-Gear Case Cap Screw Torque .....	30 N·m (22 lb-ft)

MX,15911015,3 -19-13JUL95

**METRIC BOLT AND CAP SCREW TORQUE VALUES**

10  
15  
4

TS1163 -19-04/MAR91

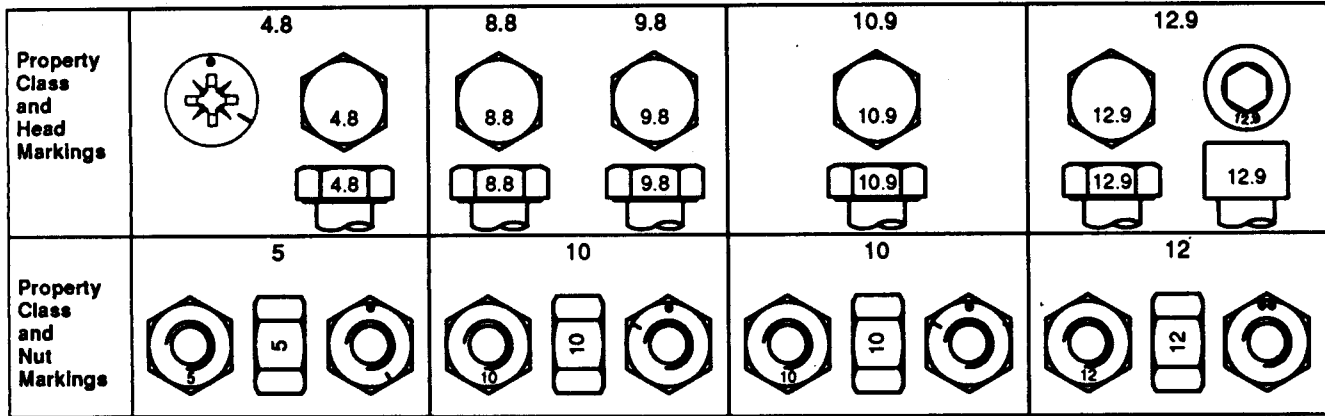

Size	Class 4.8				Class 8.8 or 9.8				Class 10.9				Class 12.9			
	Lubricated <sup>a</sup>		Dry <sup>a</sup>		Lubricated <sup>a</sup>		Dry <sup>a</sup>		Lubricated <sup>a</sup>		Dry <sup>a</sup>		Lubricated <sup>a</sup>		Dry <sup>a</sup>	
	N-m	lb-ft	N-m	lb-ft	N-m	lb-ft	N-m	lb-ft	N-m	lb-ft	N-m	lb-ft	N-m	lb-ft	N-m	lb-ft
M6	4.8	3.5	6	4.5	9	6.5	11	8.5	13	9.5	17	12	15	11.5	19	14.5
M8	12	8.5	15	11	22	16	28	20	32	24	40	30	37	28	47	35
M10	23	17	29	21	43	32	55	40	63	47	80	60	75	55	95	70
M12	40	29	50	37	75	55	95	70	110	80	140	105	130	95	165	120
M14	63	47	80	60	120	88	150	110	175	130	225	165	205	150	260	190
M16	100	73	125	92	190	140	240	175	275	200	350	255	320	240	400	300
M18	135	100	175	125	260	195	330	250	375	275	475	350	440	325	560	410
M20	190	140	240	180	375	275	475	350	530	400	675	500	625	460	800	580
M22	260	190	330	250	510	375	650	475	725	540	925	675	850	625	1075	800
M24	330	250	425	310	650	475	825	600	925	675	1150	850	1075	800	1350	1000
M27	490	360	625	450	950	700	1200	875	1350	1000	1700	1250	1600	1150	2000	1500
M30	675	490	850	625	1300	950	1650	1200	1850	1350	2300	1700	2150	1600	2700	2000
M33	900	675	1150	850	1750	1300	2200	1650	2500	1850	3150	2350	2900	2150	3700	2750
M36	1150	850	1450	1075	2250	1650	2850	2100	3200	2350	4050	3000	3750	2750	4750	3500

DO NOT use these values if a different torque value or tightening procedure is given for a specific application. Torque values listed are for general use only. Check tightness of fasteners periodically.

Shear bolts are designed to fail under predetermined loads. Always replace shear bolts with identical property class.

Fasteners should be replaced with the same or higher property class. If higher property class fasteners are used, these should only be tightened to the strength of the original.

<sup>a</sup> "Lubricated" means coated with a lubricant such as engine oil, or fasteners with phosphate and oil coatings. "Dry" means plain or zinc plated without any lubrication.

Make sure fasteners threads are clean and that you properly start thread engagement. This will prevent them from failing when tightening.

Tighten plastic insert or crimped steel-type lock nuts to approximately 50 percent of the dry torque shown in the chart, applied to the nut, not to the bolt head. Tighten toothed or serrated-type lock nuts to the full torque value.

**UNIFIED INCH BOLT AND CAP SCREW TORQUE VALUES**

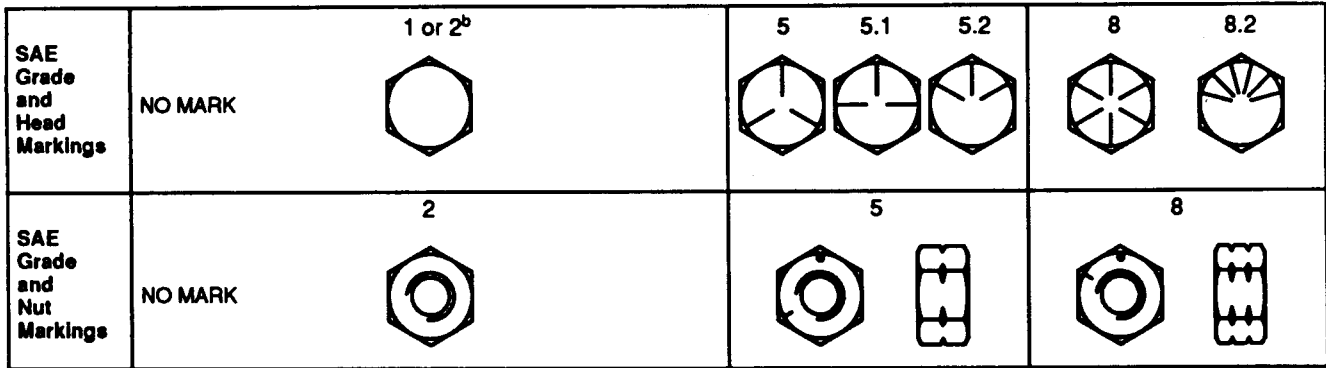

Size	Grade 1				Grade 2 <sup>b</sup>				Grade 5, 5.1, or 5.2				Grade 8 or 8.2			
	Lubricated <sup>a</sup>		Dry <sup>a</sup>		Lubricated <sup>a</sup>		Dry <sup>a</sup>		Lubricated <sup>a</sup>		Dry <sup>a</sup>		Lubricated <sup>a</sup>		Dry <sup>a</sup>	
	N-m	lb-ft	N-m	lb-ft	N-m	lb-ft	N-m	lb-ft	N-m	lb-ft	N-m	lb-ft	N-m	lb-ft	N-m	lb-ft
1/4	3.7	2.8	4.7	3.5	6	4.5	7.5	5.5	9.5	7	12	9	13.5	10	17	12.5
5/16	7.7	5.5	10	7	12	9	15	11	20	15	25	18	28	21	35	26
3/8	14	10	17	13	22	16	27	20	35	26	44	33	50	36	63	46
7/16	22	16	28	20	35	26	44	32	55	41	70	52	80	58	100	75
1/2	33	25	42	31	53	39	67	50	85	63	110	80	120	90	150	115
9/16	48	36	60	45	75	56	95	70	125	90	155	115	175	130	225	160
5/8	67	50	85	62	105	78	135	100	170	125	215	160	240	175	300	225
3/4	120	87	150	110	190	140	240	175	300	225	375	280	425	310	550	400
7/8	190	140	240	175	190	140	240	175	490	360	625	450	700	500	875	650
1	290	210	360	270	290	210	360	270	725	540	925	675	1050	750	1300	975
1-1/8	400	300	510	375	400	300	510	375	900	675	1150	850	1450	1075	1850	1350
1-1/4	570	425	725	530	570	425	725	530	1300	950	1650	1200	2050	1500	2600	1950
1-3/8	750	550	950	700	750	550	950	700	1700	1250	2150	1550	2700	2000	3400	2550
1-1/2	1000	725	1250	925	990	725	1250	930	2250	1650	2850	2100	3600	2650	4550	3350

DO NOT use these values if a different torque value or tightening procedure is given for a specific application. Torque values listed are for general use only. Check tightness of fasteners periodically.

Shear bolts are designed to fail under predetermined loads. Always replace shear bolts with identical grade.

<sup>a</sup> "Lubricated" means coated with a lubricant such as engine oil, or fasteners with phosphate and oil coatings. "Dry" means plain or zinc plated without any lubrication.

<sup>b</sup> Grade 2 applies for hex cap screws (not hex bolts) up to 152 mm (6-in.) long. Grade 1 applies for hex cap screws over 152 mm (6-in.) long, and for all other types of bolts and screws of any length.

Fasteners should be replaced with the same or higher grade. If higher grade fasteners are used, these should only be tightened to the strength of the original.

Make sure fasteners threads are clean and that you properly start thread engagement. This will prevent them from failing when tightening.

Tighten plastic insert or crimped steel-type lock nuts to approximately 50 percent of the dry torque shown in the chart, applied to the nut, not to the bolt head. Tighten toothed or serrated-type lock nuts to the full torque value.

10 5 15 19-04/MAR91 TS1162

**METRIC CAP SCREW TORQUE  
VALUES—GRADE 7**

*NOTE: When bolting aluminum parts, tighten to 80% of torque specified in table.*

Size	N-m	(lb-ft)
M6	9.5 - 12.2	(7-9)
M8	20.3 - 27.1	(15-20)
M10	47.5 - 54.2	(35-40)
M12	81.4 - 94.9	(60-70)
M14	128.8 - 146.4	(95-108)
M16	210.2 - 240	(155-177)

MX,15901015,3 -19-01MAR95

**SET SCREW SEATING TORQUE CHART**

Screw Size	Cup Point	Square Head
Torque in Inch Pounds		
#5	(1.02 N-m) 9	—
#6	(1.02 N-m) 9	—
#8	(2.26 N-m) 20	—
#10	(3.73 N-m) 33	—
1/4	(9.83 N-m) 87	(23.96 N-m) 212
5/16	(18.65 N-m) 165	(47.46 N-m) 420
3/8	(32.77 N-m) 290	(93.79 N-m) 830
7/16	(48.59 N-m) 430	—
1/2	(70.06 N-m) 620	(237.30 N-m) 2100
9/16	(70.06 N-m) 620	—
5/8	(138.43 N-m) 1225	(480.25 N-m) 4250
3/4	(240.13 N-m) 2125	(870.10 N-m) 7700

*NOTE: Allow a tolerance of plus or minus 10 per cent on all torques given in this chart.*

*Divide readings by 12 for foot-pound values.*

MX,TORQ,SET -19-09DEC94

M77900 -19-15DEC94

## SERVICE RECOMMENDATIONS FOR O-RING BOSS FITTINGS

### STRAIGHT FITTING

1. Inspect O-ring boss seat for dirt or defects.
2. Lubricate O-ring with petroleum jelly. Place electrical tape over threads to protect O-ring. Slide O-ring over tape and into O-ring groove of fitting. Remove tape.
3. Tighten fitting to torque value shown on chart.

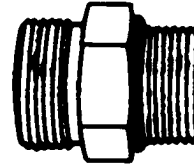

### ANGLE FITTING

1. Back-off lock nut (A) and back-up washer (B) completely to head-end (C) of fitting.
2. Turn fitting into threaded boss until back-up washer contacts face of boss.
3. Turn fitting head-end counterclockwise to proper index (maximum of one turn).
4. Hold fitting head-end with a wrench and tighten locknut and back-up washer to proper torque value.

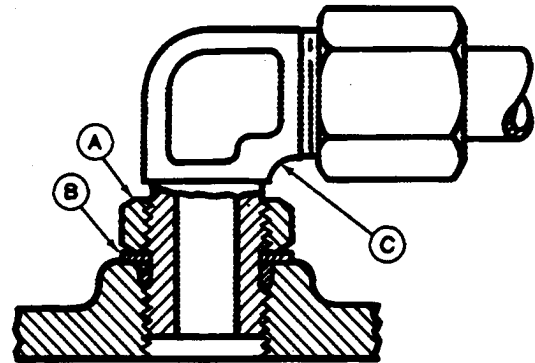

*NOTE: Do not allow hoses to twist when tightening fittings.*

### TORQUE VALUE

Thread Size	N-m	lb-ft
3/8-24 UNF	8	6
7/16-20 UNF	12	9
1/2-20 UNF	16	12
9/16-18 UNF	24	18
3/4-16 UNF	46	34
7/8-14 UNF	62	46
1-1/16-12 UN	102	75
1-3/16-12 UN	122	90
1-5/16-12 UN	142	105
1-5/8-12 UN	190	140
1-7/8-12 UN	217	160

*NOTE: Torque tolerance is  $\pm 10\%$ .*

MX,159110153,A -19-13JUL95

10  
15  
7  
-UN-18OCT88  
T6249AE  
-UN-18OCT88  
T6520AB

## SERVICE RECOMMENDATIONS FOR FLAT FACE O-RING SEAL FITTINGS

1. Inspect the fitting sealing surfaces. They must be free of dirt or defects.
2. Inspect the O-ring. It must be free of damage or defects.
3. Lubricate O-rings and install into groove using petroleum jelly to hold in place.
4. Push O-ring into the groove with plenty of petroleum jelly so O-ring is not displaced during assembly.
5. Index angle fittings and tighten by hand pressing joint together to insure O-ring remains in place.
6. Tighten fitting or nut to torque valve shown on the chart per dash size stamped on the fitting. Do not allow hoses to twist when tightening fittings.

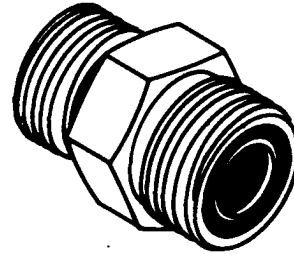

T6249AD -JUN-18OCT88

FLAT FACE O-RING SEAL FITTING TORQUE

Nominal Tube mm	O.D. (in.)	Dash Size	Thread Size In.	Swivel Nut Torque		Bulkhead Nut Torque	
				N-m	(lb-ft)	N-m	(lb-ft)
6.35	0.250	-4	9/16-18	16	12	5.0	3.5
9.52	0.375	-6	11/16-16	24	18	9.0	6.5
12.70	0.500	-8	13/16-16	50	37	17.0	12.5
15.88	0.625	-10	1-14	69	51	17.0	12.5
19.05	0.750	-12	1 3/16-12	102	75	17.0	12.5
22.22	0.875	-14	1 3/16-12	102	75	17.0	12.5
25.40	1.000	-16	1 7/16-12	142	105	17.0	12.5
31.75	1.250	-20	1 11/16-12	190	140	17.0	12.5
38.10	1.500	-24	2-12	217	160	17.0	12.5

NOTE: Torque tolerance is +15 -20%.

OR,SEAL,FIT -19-03MAR89

## **TUBE AND HOSE FITTING, 37° FLARE AND 30° CONE SEAT CONNECTOR SERVICE RECOMMENDATIONS**

1. Inspect the flare and the flare seat. They must be free of dirt and defects. If repeated leaks occur, inspect for defects with a magnifying glass. If burrs and raised nicks on the connector body cannot be removed with a slip stone, replace the connector.
2. Defects in the tube flare cannot be repaired. Replace the tube. Overtightening a defective flared fitting will not stop leaks.
3. As a field repair, a ductile truncated cone shaped washer can be used between the tube flare and connector body. These washers are soft enough to fill defects in the seat and flare. They will also seal the connection. Ductile washers are available from industrial supply houses.
4. Align the tube with the fitting before attempting to start the nut. Failure to do so can cause a deformed flare and subsequent leaks. Install hoses without twists. A twisted hose attempts to straighten out when pressure is applied. This exerts a torque on the connection, eventually causing failure.
5. Lubricate the connection with hydraulic fluid, petroleum jelly or soap. Tighten the swivel nut by hand until it is snug.
6. Mark a line across the nut and connector body. This line will serve as a visual indicator as to whether the nut has been tightened and by how much.
7. Using two wrenches, one on the connector body and a torque wrench on the nut, tighten the nut to the torque value as shown in the chart. In the case of a hose, it may be necessary to use three wrenches to prevent twisting.

MX,15901015,4 -19-17JAN95

10  
15  
9

TUBE AND HOSE FITTING, 37° FLARE AND 30° CONE SEAT CONNECTOR TORQUE

Thread Size	N·m	Torque <sup>1</sup> (lb-ft)	New <sup>2</sup> Number of Flats	Used <sup>3</sup> Number of Flats
3/8-24 UNF	8	(6)	2-1/2	1
7/16-20 UNF	12	(9)	2-1/2	1
1/2-20 UNF	16	(12)	2-1/2	1
9/16-18 UNF	24	(18)	2	1
3/4-16 UNF	46	(34)	2	1
7/8-14 UNF	62	(46)	1-1/2	1
1-1/16-12 UN	102	(75)	1	3/4
1-3/16-12 UN	122	(90)	1	3/4
1-5/16-12 UN	142	(105)	3/4	3/4
1-5/8-12 UN	190	(140)	3/4	3/4
1-7/8-12 UN	217	(160)	1/2	1/2

1. Tolerance of ± 10 percent.

2. To be used if a torque wrench cannot be used. After tightening fitting by hand, put a mark across the fittings, then tighten fitting the number of flats shown.

3. Flare connection seal by deforming or squeezing the tube between the nut and the connector. More deformation is possible with new parts than with old. Therefore, if a torque wrench is not used for re-assembly, the values in this column must be used to prevent damage.

MX,15901015,5 -19-17JAN95

**TEST AND ADJUSTMENT SPECIFICATIONS**

Item	Specifications
<b>ENGINE—322</b>	
Slow Idle Speed	
3TG66UJ .....	1350 ± 50 rpm
Fast Idle Speed	
3TG66UJ .....	3450 ± 50 rpm
Fuel Pump	
Minimum Fuel Flow	
3TG66UJ .....	200 mL (7 oz.)/30 seconds
Minimum Fuel Pressure	
3TG66UJ .....	14 kPa (2 psi)
Choke Plate Clearance (Later models) .....	2 mm (0.78 in.)
Oil Pressure	
3TG66UJ .....	294—440 kPa (43—64 psi)
Spark Plug Gap	
3TG66UJ .....	0.80 mm (0.032 in.)
Cooling System Pressure Test	
3TG66UJ .....	117 kPa (17 psi)
Minimum Pressure After After 15 Seconds	
3TG66UJ .....	90 kPa (13 psi)
Radiator Cap	
Opening Pressure	
3TG66UJ .....	97—104 kPa (14—15 psi)
Compression	
Minimum	
3TG66UJ .....	779 kPa (113 psi)
Maximum Difference Between Cylinders	
3TG66UJ .....	97 kPa (14 psi)
Engine Cranking Speed	
3TG66UJ .....	300 rpm

MX,15911020,1 -19-13JUL95

10  
20  
1

Test and Adjustment Specifications

10  
20  
2

Item	Specifications
ENGINE—330, 332, and 430	
Fuel Pump	
Minimum Fuel Flow	
3TN66UJ . . . . .	200 mL (7 oz.)/30 seconds
3TNA72UJ . . . . .	600 mL (20 oz.)/30 seconds
Minimum Fuel Pressure	
3TN66UJ . . . . .	21 kPa (3 psi)
3TNA72UJ . . . . .	21 kPa (3 psi)
Compression	
Minimum	
3TN66UJ . . . . .	2448 kPa (355 psi)
3TNA72UJ . . . . .	2448 kPa (355 psi)
Maximum Difference Between Cylinders	
3TN66UJ . . . . .	490 kPa (71 psi)
3TNA72UJ . . . . .	490 kPa (71 psi)
Minimum Engine Cranking Speed . . . . .	250 rpm
Oil Pressure	
3TN66UJ . . . . .	365 ±69 kPa (53 ±10 psi)
3TNA72UJ . . . . .	365 ±69 kPa (53 ±10 psi)
Slow Idle Speed	
3TN66UJ and Later 3TNA72UJ . . . . .	1350 ± 50 rpm
Early 3TNA72UJ . . . . .	1300 ± 50 rpm
Fast Idle Speed	
3TN66UJ and Later 3TNA72UJ . . . . .	3450 ± 50 rpm
Early 3TNA72UJ . . . . .	3400 ± 50 rpm
Cooling System Pressure Test	
3TN66UJ . . . . .	117 kPa (17 psi)
3TNA72UJ . . . . .	117 kPa (17 psi)
Minimum Pressure After After 15 Seconds	
3TN66UJ . . . . .	90 kPa (13 psi)
3TNA72UJ . . . . .	90 kPa (13 psi)
Radiator Cap	
Opening Pressure	
3TN66UJ . . . . .	97—104 kPa (14—15 psi)
3TNA72UJ . . . . .	97—104 kPa (14—15 psi)
Fuel Injection Pump Cover Nut Torque	
3TN66UJ and Later 3TNA72UJ . . . . .	9 N·m (78 lb-in.)
Fuel Injection Pump Cover Cap Screw Torque	
Early 3TNA72UJ . . . . .	9 N·m (78 lb-in.)

MX,15911020,3 -19-13JUL95

*Test and Adjustment Specifications*

10  
20  
3

Item	Specifications
<b>ELECTRICAL SYSTEM</b>	
Pulser Coils—322	
Minimum Voltage Output . . . . .	0.05 VAC
Resistance . . . . .	15.5—23.3 ohms
Ignition Coils—322	
Primary Coil Resistance . . . . .	3.8—5.2 ohms
Secondary Coil Resistance . . . . .	10.8—16.2 K-ohms
Glow Plugs—330, 332 and 430	
Minimum Resistance . . . . .	1.00 ohms
PTO Clutch Armature-to-Rotor Clearance . . . . .	
	0.46 mm (0.018 in.)
Starter—322, 330 and 332	
Current Draw (Maximum) . . . . .	230 amps
No-Load rpm (Minimum) . . . . .	7000 rpm
No-Load Amp Draw (Maximum) . . . . .	60 amps
Starter—430	
Current Draw (Maximum) . . . . .	230 amps
No-Load rpm (Minimum) . . . . .	3000 rpm
No-Load Amp Draw (Maximum) . . . . .	90 amps
Fuel Shutoff Solenoid (430 S.N. —420468)	
Lever-to-Stop Clearance . . . . .	2 mm (0.080 in.)
Alternator—322, 330 and 332	
Regulated Voltage Output . . . . .	13.5—15 volts
Unregulated Voltage Output (Minimum) . . . . .	30 volts
Regulated Current Output (Minimum) . . . . .	18 amps
Alternator—430	
Regulated Voltage Output . . . . .	13.8—14.7 volts
Unregulated Current Output (Minimum)	
(S.N. —420468) . . . . .	35 amps
(S.N. 420469— ) . . . . .	40 amps
<b>POWER TRAIN</b>	
Oil Temperature for Hydraulic Tests . . . . .	43°C (110°F)
Charge Pump Pressure . . . . .	620—1240 kPa (90—180 psi)
Implement Relief Valve Pressure . . . . .	5861—6722 kPa (850—975 psi)
Minimum Charge Pump Flow at 3450 kPa (500 psi) . . . . .	11 L/min (3 gpm)
322, 332 and 430; Steering Valve Pressure in Neutral Position . . . . .	620—1240 kPa (90—180 psi)
Hydrostatic Lever Tension . . . . .	31—44.5 N (7—10 lb force)
Turnbuckle Lock Nut Torque	
(Transmission Control Lever Linkage, 330 and Version One—322, 332 and 430) . . . . .	33 N·m (24 lb-ft)
Detent Spring Length (Transmission Control Lever Linkage, Later Versions—322, 332 and 430) . . . . .	
	50 mm (1.970 in.)

MX,15911020,2 -19-13JUL95

Test and Adjustment Specifications

10  
20  
4

Item	Specifications
<b>STEERING AND BRAKES</b>	
Oil Temperature for Hydraulic Tests . . . . .	43°C (110°F)
Steering System Leakage Test at Slow Idle	
Torque Applied to Steering Wheel Nut . . . . .	6.8 N·m (60 lb-in.)
Maximum Left and Right Turn rpm . . . . .	6 rpm
<b>HYDRAULIC SYSTEM</b>	
Oil Temperature for Hydraulic Tests . . . . .	43°C (110°F)
Control Valve Leakage Test	
Control Valve Pressure . . . . .	5860—6550 kPa (850—950 psi)
Control Valve Leakage . . . . .	15 mL/min (1/2 fl oz/min)

MX,15911020,4 -19-13JUL95

FUEL—322

**N** CAUTION: Handle fuel carefully. If the engine is hot or running, do not fill the fuel tank. Do not smoke while you fill the fuel tank or service the fuel system. Fill fuel tank only to bottom of filler neck.

**IMPORTANT: DO NOT mix oil with gasoline.**

1. Unleaded fuel is recommended. Regular leaded gasoline with an anti-knock index of 87 or higher may be used. Avoid switching from unleaded to regular gasoline to prevent engine damage.

Use of gasohol is acceptable as long as the ethyl alcohol blend does not exceed 10 percent. Unleaded gasohol is preferred over leaded gasohol.

2. Fill fuel tank at end of each day's operation. Fill fuel tank only to bottom of filler neck.



10  
25  
1  
-JUN-25AUG88  
M33122

MX,15911025,1 -19-13JUL95

## DIESEL FUEL—330, 332 AND 430

Consult your local fuel distributor for properties of the diesel fuel available in your area.

In general, diesel fuels are blended to satisfy the low temperature requirements of the geographical area in which they are marketed. Recommended standard grades are shown on the temperature charts.

Diesel fuels meeting Military Specification VV-F-800E are preferred. If diesel fuel specified to ASTM D975 is used, the fuel must meet the following properties:

- Cetane Number 40 minimum.  
Cetane number greater than 50 is preferred, especially for temperatures below  $-20^{\circ}\text{C}$  ( $-4^{\circ}\text{F}$ ) or elevations above 1500 m (5000 ft).
- Cold Filter Plugging Point (CFPP) below the expected low temperature OR Cloud Point at least  $5^{\circ}\text{C}$  ( $9^{\circ}\text{F}$ ) below the expected low temperature
- Sulfur content:
  - Sulfur content should not exceed 0.5% Sulfur content less than 0.05% is preferred.
  - If diesel fuel with sulfur content greater than 0.5% sulfur content is used, reduce the service interval for engine oil and filter by 50%
  - DO NOT use diesel fuel with sulfur content greater than 1.0%
- Lubricity
  - Fuel lubricity must pass the BOCLE scuffing test at 3300 gram minimum load level.
  - If fuel of low or unknown lubricity is used, add John Deere All-Season Diesel Fuel Conditioner at specified concentration.

Bio-diesel fuels with these properties and meeting an appropriate specification may be used as an alternative to petroleum-based diesel fuel.

Arctic fuels (such as Military Specification VV-F-800E, Grade DF-A) may be used at temperatures below  $-30^{\circ}\text{C}$  ( $-22^{\circ}\text{F}$ ).

**N** **CAUTION: Handle fuel carefully. Do not fill the fuel tank when engine is running. DO NOT smoke while you fill the fuel tank or service the fuel system.**

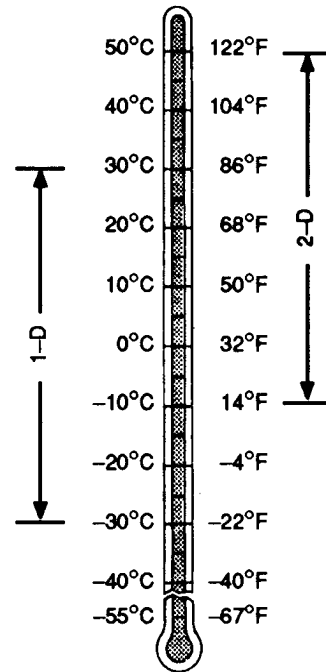

North America ASTM D975

## STORING FUEL

If there is a very slow turnover of fuel in the fuel tank or supply tank, it may be necessary to add a fuel conditioner to prevent water condensation. Contact your John Deere dealer for proper service or maintenance recommendations.

DX,FUEL -19-03MAR93

## DO NOT USE GALVANIZED CONTAINERS

**IMPORTANT: Diesel fuel stored in galvanized containers reacts with zinc coating on the container to form zinc flakes. If fuel contains water, a zinc gel will also form. The gel and flakes will quickly plug fuel filters and damage fuel injectors and fuel pumps.**

DO NOT USE a galvanized container to store diesel fuel.

Store fuel in:

- plastic containers.
- aluminum containers.
- specially coated steel containers made for diesel fuel.

DO NOT USE brass-coated containers: brass is an alloy of copper and zinc.

M21,FLQ,B1 -19-02AUG85

## ENGINE OIL—322

Use oil viscosity based on the expected air temperature range during the period between oil changes.

The following oils are preferred:

- John Deere TURF-GARD™
- John Deere PLUS-4®

Other oils may be used if they meet one or more of the following:

- API Service Classification SH
- API Service Classification SG
- CCMC Specification G5

Arctic oils (such as Military Specification MIL-L-46167B) may be used at temperature below -30°C (-22°F).

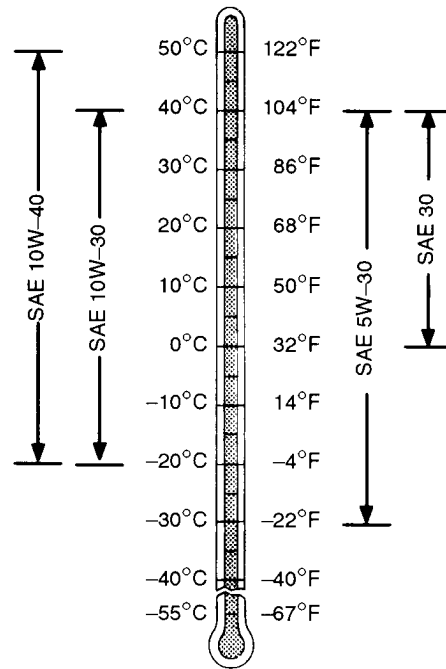

TS1624 -JUN-07NOV/94

MX,15911025,3 -19-13JUL95

## DIESEL ENGINE OIL—330, 332 AND 430

Use oil viscosity based on the expected air temperature range during the period between oil changes.

Viscosity grade SAE 15W-40 is preferred.

If other viscosity grades are used, reduce the service interval for oil and filter changes by 50%

The following oil is preferred:

- John Deere TORQ-GARD SUPREME<sup>®</sup> PLUS-50™

If John Deere TORQ-GARD SUPREME PLUS-50 engine oil and a John Deere oil filter are used, the service interval for oil and filter changes may be extended by 50 hours.

The following oil is also recommended:

- John Deere TORQ-GARD SUPREME<sup>®</sup>

Other oils may be used if they meet one or more of the following:

- API Service Classification CG4
- API Service Classification CF4
- API Service Classification CE

Oils meeting one of the following may be used, but reduce the service interval for engine oil and filter changes by 50%:

- John Deere UNI-GARD™
- CCMC Specification D5
- CCMC Specification D4

If diesel fuel with sulfur content greater than 0.5% is used, reduce the service interval for engine oil and filter by 50%

Arctic oils (such as Military Specification MIL-L-46167B) may be used at temperatures below -30°C (-22°F). Reduce the service interval for oil and filter changes by 50%

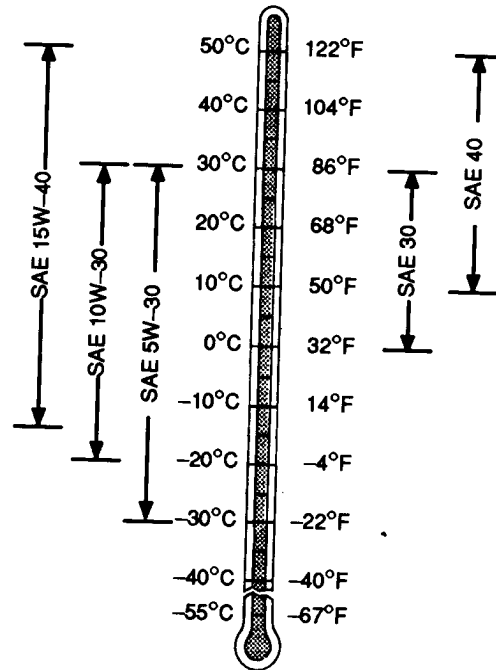

## ENGINE COOLANT

John Deere Low Silicate Antifreeze is recommended.

Also recommended is low silicate antifreeze formulated to GM6038M or equivalent.

Other antifreezes that may be used:

- Ethylene-glycol type.
- Those containing not more than 0.1 percent anhydrous metasilicate.
- Those meeting General Motors Performance Specification GM1899M

**IMPORTANT: Some types of ethylene-glycol antifreeze are intended for automotive use. These products are often labeled for use in aluminum engines and usually contain more than 0.1 percent of anhydrous metasilicate.**

Check container label or consult with antifreeze supplier before using.

Mix 50-67 percent low silicate antifreeze with 33-50 percent distilled or deionized water.

Low silicate antifreeze provides:

- Adequate heat transfer.
- Corrosion-resistant environment within the cooling system.
- Compatibility with cooling system hose and seal material.
- Protection during cold and hot weather operations.

Certain geographical areas may require special antifreeze or coolant practices. If you have any questions, consult your authorized servicing dealer to obtain the latest information and recommendations.

DX,COOL -19-04JUN90

## LIQUID COOLANT CONDITIONER

John Deere Liquid Coolant Conditioner is recommended for wet-sleeve diesel engines not having a coolant filter option. Other conditioners may be used if it contains non-chromate inhibitors.

**IMPORTANT: If engine is equipped with a John Deere Coolant Filter Conditioner, the correct inhibitors are contained in the filter. If both are used, a gel-type deposit is created which could inhibit heat transfer and block coolant flow. John Deere Liquid Coolant Conditioner does not protect against freezing.**

Various sizes of coolant conditioners are available from your John Deere dealer.



RG4690 -UN-14DEC88

DX,COOL1 -19-04JUN90

## TRANSMISSION AND HYDRAULIC OIL

Use oil viscosity based on the expected air temperature range during the period between oil changes.

The following oils are preferred:

- John Deere HY-GARD®
- John Deere Low Viscosity HY-GARD®

The following oils are also recommended:

- John Deere UNI-GARD™
- John Deere BIO-HY-GARD™<sup>1</sup>

Other oils may be used if they meet one of the following:

- John Deere Standard JDM J20C
- John Deere Standard JDM J20D
- John Deere Standard JDM J27A

**IMPORTANT: Do not use engine oil for this application.**

Arctic oils (such as Military Specification MIL-L-46167B) may be used at temperatures below -30°C (-22°F).

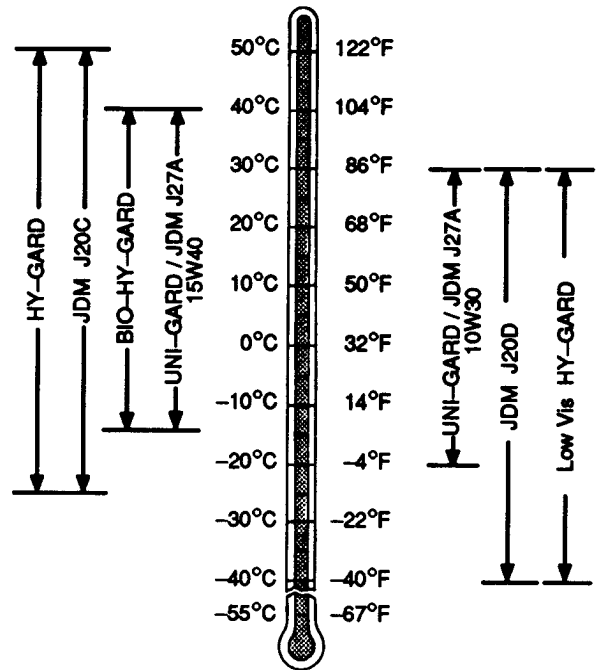

<sup>1</sup>BIO-HY-GARD meets or exceeds the minimum biodegradability of 80% within 21 days according to CEC-L-33-T-82 test method. BIO-HY-GARD should not be mixed with mineral oils because this reduces the biodegradability and makes proper oil recycling impossible.

10  
25  
8

## GREASE

Use grease based on the expected air temperature range during the service interval.

The following greases are preferred:

- John Deere MOLY HIGH TEMPERATURE EP GREASE
- John Deere HIGH TEMPERATURE EP GREASE
- John Deere GREASE-GARD™

Other greases may be used if they meet one of the following:

- SAE Multipurpose EP Grease with a maximum of 5% molybdenum disulfide
- SAE Multipurpose EP Grease

Greases meeting Military Specification MIL-G-10924F may be used as arctic grease.

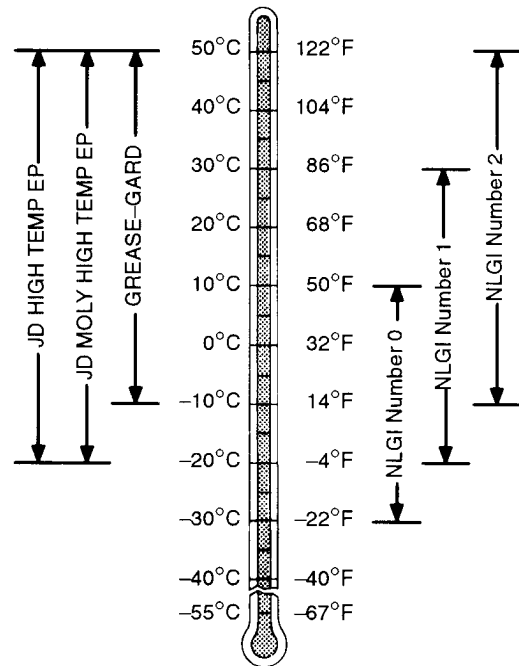

DX.GREA1 -19-02NOV94

TS1622 -UN-02NOV94

## MOWER DECK GEAR CASE OIL

Depending upon the expected air temperature range during the drain interval, use oil viscosity shown on the adjoining temperature chart.

John Deere API GL-5 Gear Oil is recommended. If other oils are used, they must meet performance requirements of:

- API Service Classification GL-5
- Military Specifaciton MIL-L-2105C

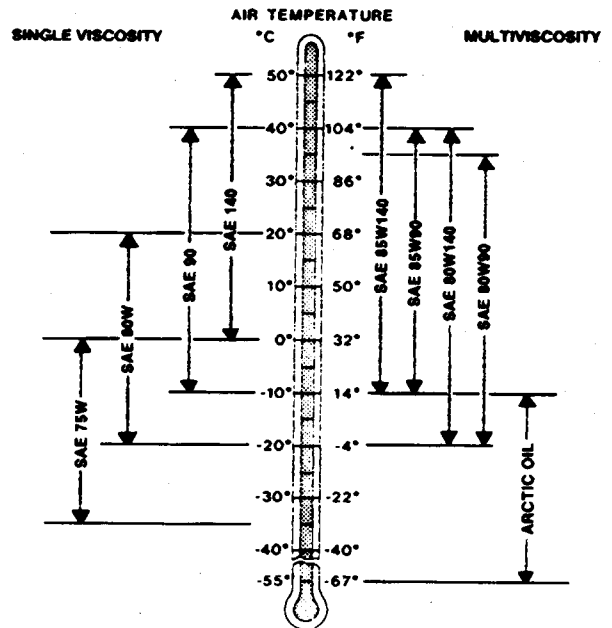

MX,15901025,3 -19-14FEB95

X9322 -19-30SEP88

## ALTERNATIVE AND SYNTHETIC LUBRICANTS

Conditions in certain geographical areas may require lubricant recommendations different from those printed in this manual. Some John Deere lubricants may not be available in your location. Consult your John Deere dealer to obtain information and recommendations.

Synthetic lubricants may be used if they meet the performance requirements listed in this manual.

DX,ALTER -19-01FEB94

## LUBRICANT STORAGE

Your equipment can operate at top efficiency only if clean lubricants are used.

Use clean containers to handle all lubricants.

Whenever possible, store lubricants and containers in an area protected from dust, moisture, and other contamination. Store containers on their side to avoid water and dirt accumulation.

DX,LUBST -19-01FEB94

## MIXING OF LUBRICANTS

In general, avoid mixing different brands or types of oil. Oil manufacturers blend additives in their oils to meet certain specifications and performance requirements. Mixing different oils can interfere with the proper functioning of these additives and degrade lubricant performance.

DX,LUBMIX -19-01FEB94

## SERIAL NUMBERS

When working on machines or components that are covered by warranty, it is **IMPORTANT** that you include the tractor Product Identification Number and the component serial number on the warranty claim form.

The location of component serial number plates are shown below.

MX,M21,1030R,1 -19-22APR85

## PRODUCT IDENTIFICATION NUMBER

*NOTE: All identification number plates are located on the pedestal. On some models, the plate is on the right-hand side. On others, front top left corner.*



M34494  
-UN-08NOV89

MX,15901030,1 -19-12MAY95

## ENGINE SERIAL NUMBER



M34495  
-UN-08NOV89

MX,15911030,1 -19-13JUL95

## TRANSMISSION SERIAL NUMBER

Serial number plate (A) location.

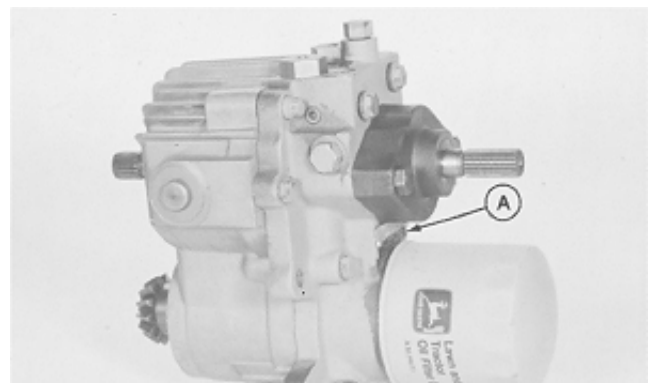

M38478  
-UN-29AUG88

MX,15901030,3 -19-12MAY95

10  
30  
2

### DIFFERENTIAL SERIAL NUMBER

Serial number plate (A) location.

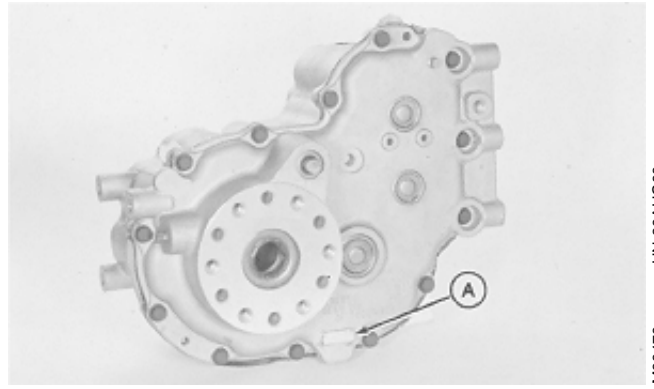

M38479 -UN-29AUG88

MX,15901030,4 -19-12MAY95

### CONTROL VALVE SERIAL NUMBER

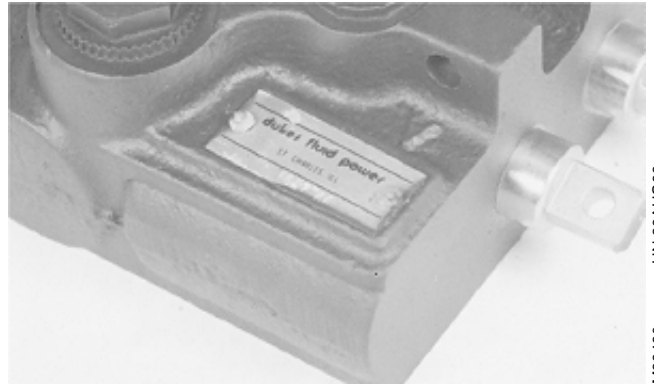

M38480 -UN-29AUG88

MX,15901030,5 -19-12MAY95

# Section 20 ENGINE REPAIR

## Contents

Page

### Group 05—Engine—322

Repair—Use CTM12 . . . . .	20-05-1
Remove and Install . . . . .	20-05-1

### Group 06—Engine—330, 332 and 430

Repair—Use CTM3 . . . . .	20-06-1
Remove and Install—330 and 332 . . . . .	20-06-1
Remove—430 . . . . .	20-06-4
Install—430 . . . . .	20-06-8

20

## YANMAR GASOLINE ENGINE REPAIR—USE CTM12

For complete repair information, the component technical manual (CTM) is also required. Use the component technical manual in conjunction with this machine manual.



MX,15912005,1 -19-13JUL95

TS225

-UN-17JAN89

20  
05

## REMOVE AND INSTALL ENGINE—322

1. Remove grille, side panels, battery, battery base and belly screen.
2. Disconnect headlight and hour meter leads.
3. Remove hood, hood support and battery base support.

**N CAUTION:** Explosive release of fluids from pressurized cooling system can cause serious burns.

**Shut off engine. Only remove filler cap when cool enough to touch with bare hands. Slowly loosen cap to first stop to relieve pressure before removing completely.**

4. Drain radiator. Approximate capacity is 2.8 L (3 U.S. qt).
5. Disconnect items (A—D).

- A—Starter Cable and Leads
- B—Alternator Lead
- C—Voltage Regulator Lead
- D—Temperature Coolant Lead

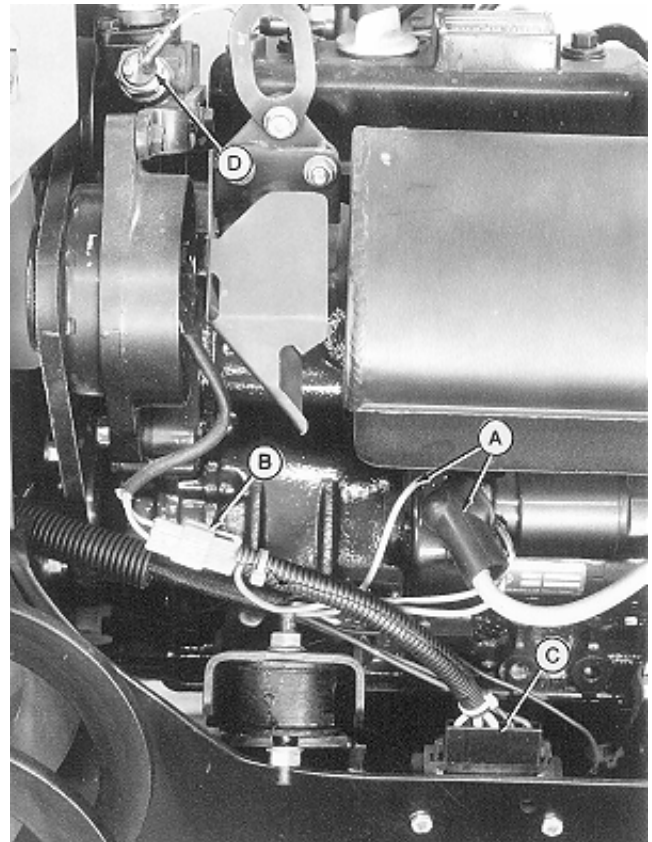

-UN-23AUG88

TS281

-UN-15DEC94

M77901

MX,15912005,2 -19-13JUL95

6. Disconnect items (A—I).

- A—Radiator Hoses
- B—Throttle Cable
- C—Choke Cable
- D—Ignition Coil Lead
- E—Ignition Trigger Lead
- F—Oil Pressure Sensor Lead
- G—PTO Clutch Lead
- H—Wire Harness Ground and Frame to Engine Ground
- I—Fuel Line at Filter

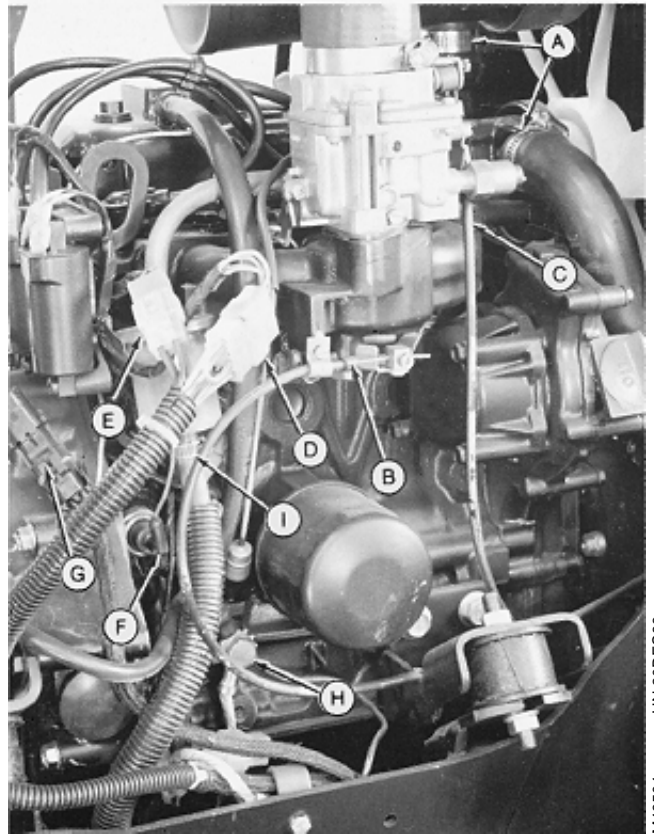

M49504 -JUN-20DEC89

MX,5M3,2005K,H -19-18DEC87

20  
05  
2

7. Remove cap screws (A) holding rubber drive shaft isolator to engine.

8. Loosen cap screws at universal joint at transmission input shaft and slide drive shaft toward transmission. This will eliminate any preload on the drive shaft when reassembling.

9. Remove engine mounting nuts.

10. Attach load positioning sling to lift eyes and remove engine.

11. Make repairs as necessary. (See CTM12.)

12. Installation is done in the reverse order of removal.

- Tighten engine mounting nuts to specifications.
- When connecting drive shaft, tighten cap screws to specifications.
- Close drain valve and fill radiator with proper coolant until coolant is 13—25 mm (0.500—1 in.) below bottom of filler neck. (See Engine Coolant in Section 10, Group 25.)

*NOTE: On Early models, the choke is activated manually by a cable. On Later models, the choke operates automatically.*

- Early models; Adjust choke cable. (See Section 220, Group 10.)
- Adjust slow and fast idle. (See Section 220, Group 10.)

**TORQUE SPECIFICATIONS**

Engine Mounting Nuts . . . . .	49 N·m (36 lb-ft)
Drive Shaft	
Engine Mounting Cap Screws . . . . .	37 N·m (27 lb-ft)
Universal Joint Cap Screws . . . . .	60 N·m (45 lb-ft)

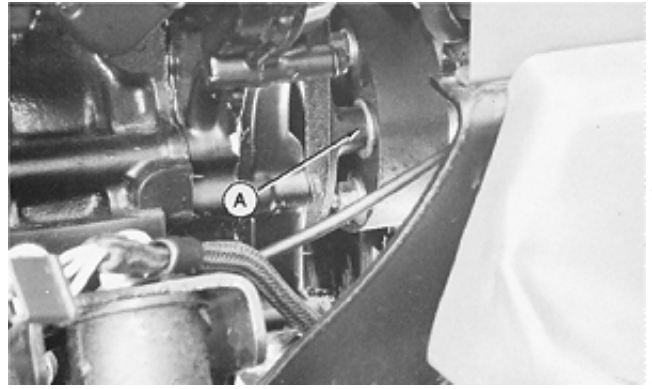

M49505 -UN-20DEC89

20  
05  
3



## YANMAR DIESEL ENGINE REPAIR—USE CTM3

For complete repair information, the component technical manual (CTM) is also required. Use the component technical manual in conjunction with this machine manual.



MX,15912006,1 -19-13JUL95

TS225

2006

## REMOVE AND INSTALL ENGINE—330 AND 332

1. Remove grille, side panels, battery, battery base and belly screen.
2. Disconnect headlight and hour meter leads.
3. Remove hood, hood support and battery base support.

**N CAUTION:** Explosive release of fluids from pressurized cooling system can cause serious burns.

**Shut off engine. Only remove filler cap when cool enough to touch with bare hands. Slowly loosen cap to first stop to relieve pressure before removing completely.**

4. Drain radiator. Approximate capacity is 2.8 L (3 U.S. qt).

*NOTE: On 330, wiring harness ground and engine-to-frame ground (D) are connected to rear engine mount.*

5. Disconnect items (A—E).

- A—Battery Positive (+) Cable and Starter Leads
- B—Alternator Lead
- C—PTO Clutch Lead
- D—Wiring Harness Ground and Engine to Frame Ground
- E—Coolant Temperature Lead

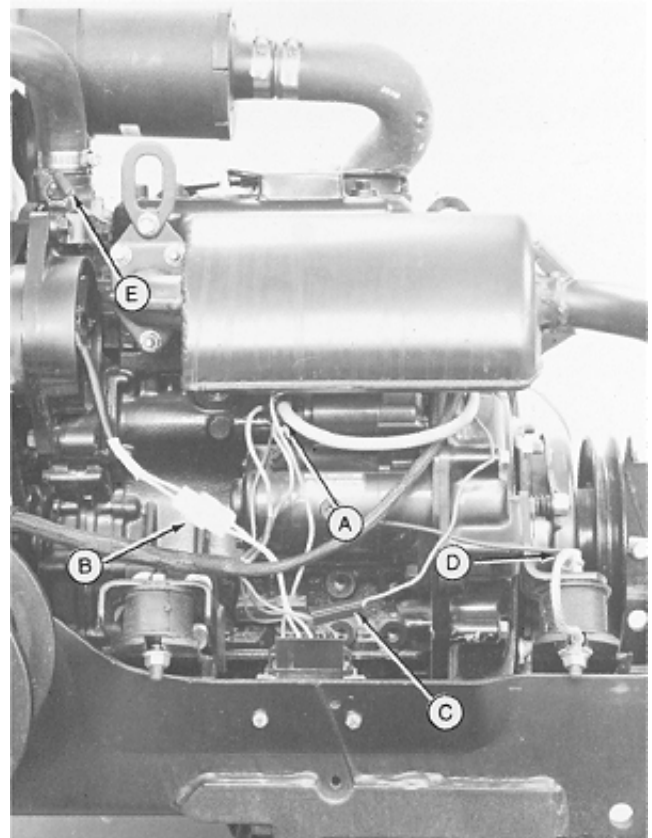
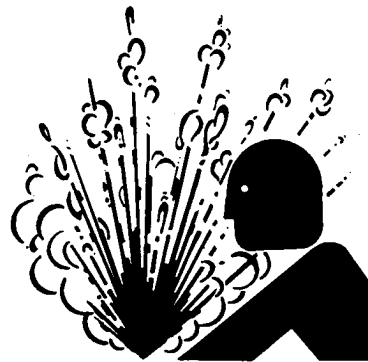

MX,15912006,2 -19-13JUL95

TS281

2006

TS281

M49506



**Suggest:**

**If the above button click is invalid.**

**Please download this document**

**first, and then click the above link**

**to download the complete manual.**

**Thank you so much for reading**

*NOTE: On Early 330, fuel shutoff solenoid is activated manually by a cable. On 332 and Later 330, fuel shutoff solenoid is activated electronically.*

6. Disconnect items (A—G).

- A—Radiator Hoses
- B—Return Fuel Line
- C—Throttle Cable
- D—Fuel Pump Hose
- E—Fuel Shutoff Solenoid Connector (332, Later 330)  
—Fuel Shutoff Solenoid Cable (Early 330)
- F—Glow Plug Lead
- G—Oil Pressure Sensor Lead

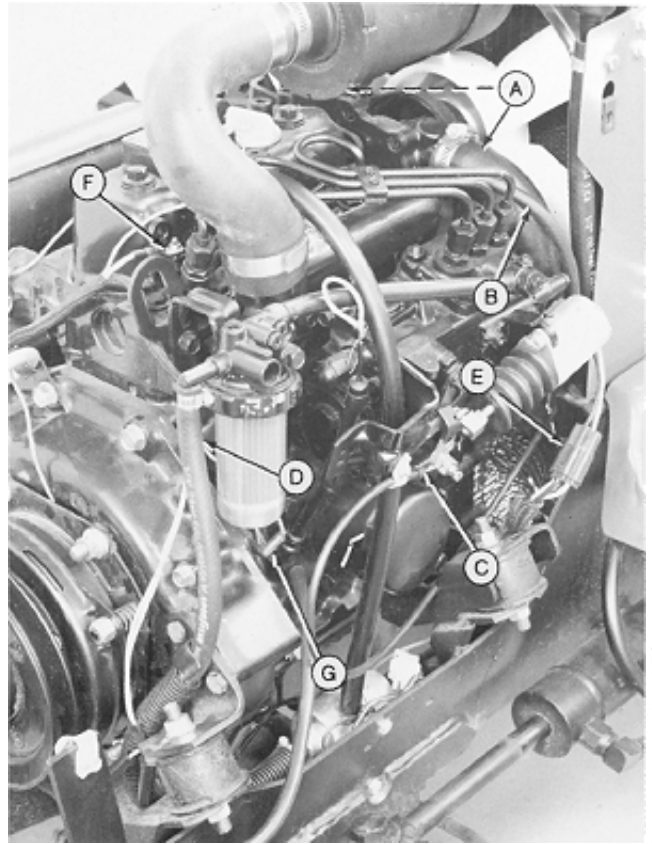

M49507 -JUN-20DEC89

MX,15912006,3 -19-13JUL95

20  
06  
2

**<https://www.ebooklibonline.com>**

Hello dear friend!

Thank you very much for reading.

Enter the link into your browser.

The full manual is available for immediate download.

**<https://www.ebooklibonline.com>**