

316, 318 and 420 Lawn and Garden Tractors

For complete service information also see:

Onan Engines (16,18,20,24 HP) CTM2

**John Deere Horicon Works
TM1590 (17MAY95)**

LITHO IN U.S.A.
ENGLISH

Contents

SECTION 10—GENERAL INFORMATION

- Group 05—Safety
- Group 10—General Specifications
- Group 15—Repair Specifications
- Group 20—Test and Adjustment Specifications
- Group 25—Fuels and Lubricants
- Group 30—Serial Number Locations

SECTION 20—ENGINE REPAIR

- Group 05—Engine

SECTION 40—ELECTRICAL REPAIR

- Group 05—Front PTO Clutch

SECTION 50—POWER TRAIN REPAIR

- Group 05—Transmission
- Group 10—Transmission Control Linkage
- Group 15—Differential
- Group 20—Rear Axles
- Group 25—Drive Shaft

SECTION 60—STEERING AND BRAKE REPAIR

- Group 05—Steering—316
- Group 06—Steering—318 and 420
- Group 10—Brakes

SECTION 70—HYDRAULIC REPAIR

- Group 05—Hydraulic Control Valve

SECTION 80—MISCELLANEOUS REPAIR

- Group 05—Front Axle
- Group 10—Mower Spindle and Jack Sheave Repair
- Group 15—Mower Gear Case Repair

SECTION 220—ENGINE, FUEL AND AIR SYSTEM CHECKOUT AND DIAGNOSIS

- Group 05—Engine, Fuel and Air System Checkout
- Group 10—Diagnosis, Tests and Adjustments

SECTION 240—ELECTRICAL CHECKOUT, OPERATION AND DIAGNOSIS

- Group 05—Electrical System Checkout
- Group 10—Electrical Schematics
- Group 15—Component Location and Operation
- Group 20—Electrical System Diagnosis
- Group 25—Electrical System Component Tests and Adjustments

SECTION 250—POWER TRAIN CHECKOUT, OPERATION AND DIAGNOSIS

- Group 05—Power Train Checkout
- Group 10—Theory of Operation
- Group 15—Diagnosis, Tests and Adjustments

SECTION 260—STEERING AND BRAKES CHECKOUT, OPERATION AND DIAGNOSIS

- Group 05—Steering And Brakes System Checkout
- Group 10—Theory of Operation
- Group 15—Diagnosis, Tests and Adjustments

SECTION 270—HYDRAULIC SYSTEM CHECKOUT, OPERATION AND DIAGNOSIS

- Group 05—Hydraulic System Checkout
- Group 10—Hydraulic Schematics
- Group 15—Theory of Operation
- Group 20—Diagnosis, Tests and Adjustments

SECTION 299—DEALER FABRICATED TOOLS

- Group 00—Dealer Fabricated Tools

Index

All information, illustrations and specifications in this manual are based on the latest information available at the time of publication. The right is reserved to make changes at any time without notice.

TM1590-19-17MAY95

COPYRIGHT© 1995
DEERE & COMPANY
Moline, Illinois
All rights reserved
A John Deere ILLUSTRATION™ Manual

Contents

10

20

40

50

60

70

80

220

240

250

<https://www.ebooklibonline.com>

Hello dear friend!

Thank you very much for reading.

Enter the link into your browser.

The full manual is available for immediate download.

<https://www.ebooklibonline.com>

260

270

299

INDX

260

270

299

INDX

Introduction

FOREWORD

This manual is written for an experienced technician. Essential tools required in performing certain service work are identified in this manual and are recommended for use.

Live with safety: Read the safety messages in the introduction of this manual and the cautions presented throughout the text of the manual.

N This is the safety-alert symbol. When you see this symbol on the machine or in this manual, be alert to the potential for personal injury.

Technical manuals are divided in two parts: repair and diagnostics. Repair sections tell how to repair the components. Diagnostic sections help you identify the majority of routine failures quickly.

Information is organized in groups for the various components requiring service instruction. At the beginning of each group are summary listings of all applicable essential tools, other materials needed to do the job and service parts kits.

Section 10, Group 15—Repair Specifications, consist of all applicable specifications, near tolerances and specific torque values for various components on each individual machine.

Section 10, Group 20—Test and Adjustment Specifications, consist of all applicable test and adjustment specifications for various systems for each individual machine.

Binders, binder labels, and tab sets can be ordered by John Deere dealers direct from the John Deere Distribution Service Center.

This manual is part of a total product support program.

FOS MANUALS—REFERENCE

TECHNICAL MANUALS—MACHINE SERVICE

COMPONENT MANUALS—COMPONENT SERVICE

Fundamentals of Service (FOS) Manuals cover basic theory of operation, fundamentals of troubleshooting, general maintenance, and basic type of failures and their causes. FOS Manuals are for training new personnel and for reference by experienced technicians.

Technical Manuals are concise guides for specific machines. Technical manuals are on-the-job guides containing only the vital information needed for diagnosis, analysis, testing, and repair.

Component Technical Manuals are concise service guides for specific components. Component technical manuals are written as stand-alone manuals covering multiple machine applications.

Dealer Presentation Sheet

JOHN DEERE DEALERS

IMPORTANT: Please remove this page and route through your service department.

This is a complete revision for models 316, 318 and 420 found in TM1277 and TM1345. The complete revision of remaining machines (322, 330, 332 and 430) can be found in TM1591. AFTER receiving both TM1590 and TM1591, please discard old TM1277 dated December 1987, TM1345 dated June 1986 and TM1309 dated July 1985.

NOTE: There are several "versions" of each model tractor. All versions were not available at time of latest printing. Some versions may not be covered.

Dealer Presentation Sheet

Section 10 GENERAL INFORMATION

Contents

Page

Group 05—Safety 10-05-1

Group 10—General Specifications

Machine Specifications 10-10-1

Group 15—Repair Specifications

Repair Specifications 10-15-1

Metric Series Torque Chart 10-15-4

Inch Series Torque Chart 10-15-5

Metric Torque Values—Grade 7 10-15-6

Set Screw Torque Chart 10-15-6

Service Recommendations

O-Ring Boss Fittings 10-15-7

Flat Face O-Ring Seal Fittings 10-15-8

Tube and Hose Fitting, 37° Flare and

30° Cone Seat Connectors 10-15-9

Group 20—Test and Adjustment

Specifications 10-20-1

Group 25—Fuels and Lubricants

Fuel 10-25-1

Storing Fuel 10-25-1

Engine Oil 10-25-2

Transmission and Hydraulic Oil 10-25-3

Grease 10-25-4

Mower Deck Gear Case Oil 10-25-4

Alternative and Synthetic Lubricants 10-25-5

Lubricant Storage 10-25-5

Mixing of Lubricants 10-25-5

Group 30—Serial Number Locations

Serial Numbers

Product Identification 10-30-1

Engine 10-30-1

Transmission 10-30-1

Differential 10-30-2

Control Valve 10-30-2

RECOGNIZE SAFETY INFORMATION

This is the safety-alert symbol. When you see this symbol on your machine or in this manual, be alert to the potential for personal injury.

Follow recommended precautions and safe operating practices.

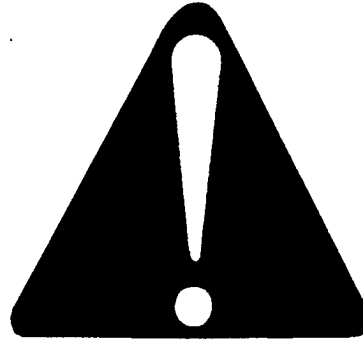

DX,ALERT -19-03MAR93

10
05
1
-UN-07DEC88
T81389

UNDERSTAND SIGNAL WORDS

A signal word—DANGER, WARNING, or CAUTION—is used with the safety-alert symbol. DANGER identifies the most serious hazards.

DANGER or WARNING safety signs are located near specific hazards. General precautions are listed on CAUTION safety signs. CAUTION also calls attention to safety messages in this manual.



DX,SIGNAL -19-03MAR93

-19-30SEP88
TS187

FOLLOW SAFETY INSTRUCTIONS

Carefully read all safety messages in this manual and on your machine safety signs. Keep safety signs in good condition. Replace missing or damaged safety signs. Be sure new equipment components and repair parts include the current safety signs. Replacement safety signs are available from your John Deere dealer.

Learn how to operate the machine and how to use controls properly. Do not let anyone operate without instruction.

Keep your machine in proper working condition. Unauthorized modifications to the machine may impair the function and/or safety and affect machine life.

If you do not understand any part of this manual and need assistance, contact your John Deere dealer.



DX,READ -19-03MAR93

-UN-23AUG88
TS201

HANDLE FLUIDS SAFELY—AVOID FIRES

When you work around fuel, do not smoke or work near heaters or other fire hazards.

Store flammable fluids away from fire hazards. Do not incinerate or puncture pressurized containers.

Make sure machine is clean of trash, grease, and debris.

Do not store oily rags; they can ignite and burn spontaneously.



DX,FLAME -19-04JUN90

-UN-23AUG88
TS227

PREVENT BATTERY EXPLOSIONS

Keep sparks, lighted matches, and open flame away from the top of battery. Battery gas can explode.

Never check battery charge by placing a metal object across the posts. Use a volt-meter or hydrometer.

Do not charge a frozen battery; it may explode. Warm battery to 16°C (60°F).



DX,SPARKS -19-03MAR93

-UN-23AUG88
TS204

PREPARE FOR EMERGENCIES

Be prepared if a fire starts.

Keep a first aid kit and fire extinguisher handy.

Keep emergency numbers for doctors, ambulance service, hospital, and fire department near your telephone.

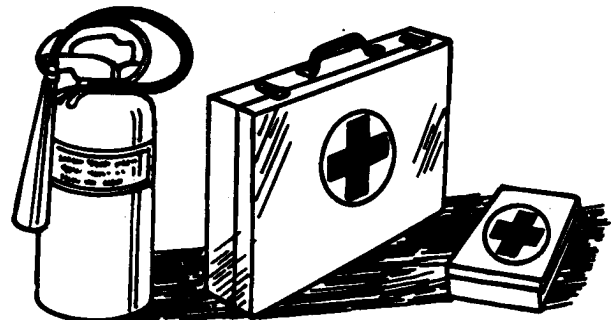

DX,FIRE2 -19-03MAR93

-UN-23AUG88
TS291

PREVENT ACID BURNS

Sulfuric acid in battery electrolyte is poisonous. It is strong enough to burn skin, eat holes in clothing, and cause blindness if splashed into eyes.

Avoid the hazard by:

1. Filling batteries in a well-ventilated area.
2. Wearing eye protection and rubber gloves.
3. Avoiding breathing fumes when electrolyte is added.
4. Avoiding spilling or dripping electrolyte.
5. Use proper jump start procedure.

If you spill acid on yourself:

1. Flush your skin with water.
2. Apply baking soda or lime to help neutralize the acid.
3. Flush your eyes with water for 15—30 minutes. Get medical attention immediately.

If acid is swallowed:

1. Do not induce vomiting.
2. Drink large amounts of water or milk, but do not exceed 2 L (2 quarts).
3. Get medical attention immediately.

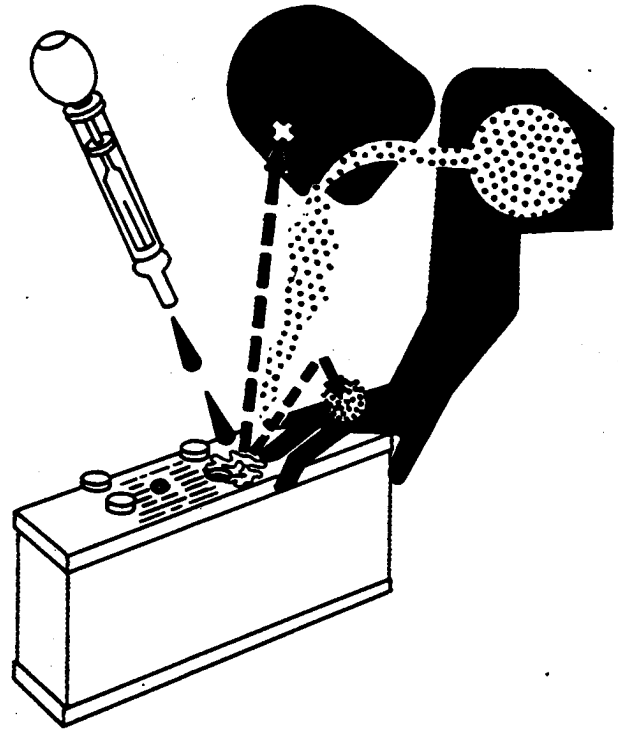

DX,POISON -19-21APR93

TS203 -UN-23AUG88

10
3
95

HANDLE CHEMICAL PRODUCTS SAFELY

Direct exposure to hazardous chemicals can cause serious injury. Potentially hazardous chemicals used with John Deere equipment include such items as lubricants, coolants, paints, and adhesives.

A Material Safety Data Sheet (MSDS) provides specific details on chemical products: physical and health hazards, safety procedures, and emergency response techniques.

Check the MSDS before you start any job using a hazardous chemical. That way you will know exactly what the risks are and how to do the job safely. Then follow procedures and recommended equipment.

(See your John Deere dealer for MSDS's on chemical products used with John Deere equipment.)

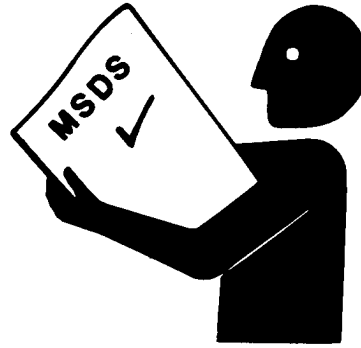

DX,MSDS,NA -19-03MAR93

TS1132 -UN-26NOV90

AVOID HIGH-PRESSURE FLUIDS

Escaping fluid under pressure can penetrate the skin causing serious injury.

Avoid the hazard by relieving pressure before disconnecting hydraulic or other lines. Tighten all connections before applying pressure.

Search for leaks with a piece of cardboard. Protect hands and body from high pressure fluids.

If an accident occurs, see a doctor immediately. Any fluid injected into the skin must be surgically removed within a few hours or gangrene may result. Doctors unfamiliar with this type of injury should reference a knowledgeable medical source. Such information is available from Deere & Company Medical Department in Moline, Illinois, U.S.A.

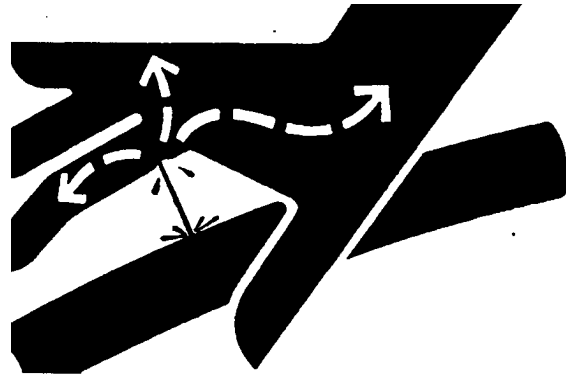

DX,FLUID -19-03MAR93

X9811 -UN-23AUG88

PREPARE MACHINE FOR REPAIR

1. Move hydrostatic control lever to STOP position.
2. Disengage PTO's
3. Lower all equipment to the ground.
4. Engage park brake.
5. Stop the engine and remove the key.
6. Operate all hydraulic control levers to release hydraulic pressure in the system.

Before you leave the operator's seat, wait for engine and attachment parts to stop moving.

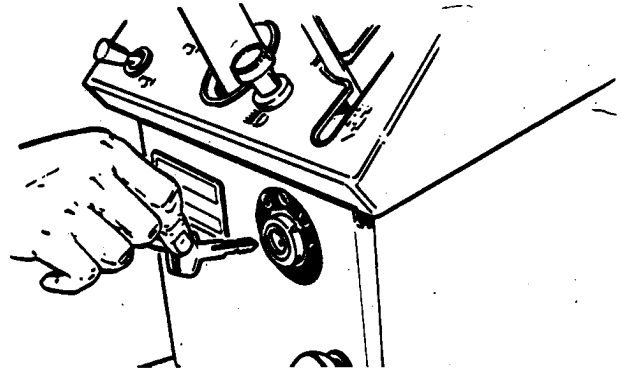

MX,1005R,8 -19-01APR86

M34228 -UN-24APR89

SUPPORT MACHINE PROPERLY

Always lower the attachment or implement to the ground before you work on the machine. If you must work on a lifted machine or attachment, securely support the machine or attachment.

Do not support the machine on cinder blocks, hollow tiles, or props that may crumble under continuous load. Do not work under a machine that is supported solely by a jack. Follow recommended procedures in this manual.

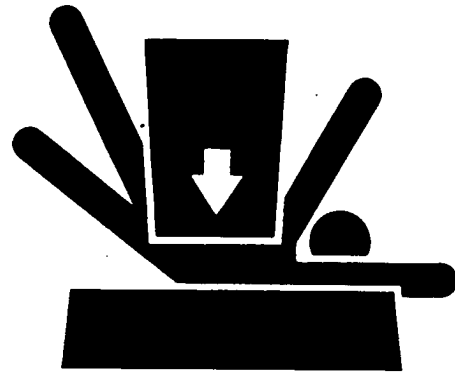

DX,LOWER -19-04JUN90

TS229 -UN-23AUG88

WEAR PROTECTIVE CLOTHING

Wear close fitting clothing and safety equipment appropriate to the job.

Prolonged exposure to loud noise can cause impairment or loss of hearing.

Wear a suitable hearing protective device such as earmuffs or earplugs to protect against objectionable or uncomfortable loud noises.

Operating equipment safely requires the full attention of the operator. Do not wear radio or music headphones while operating machine.

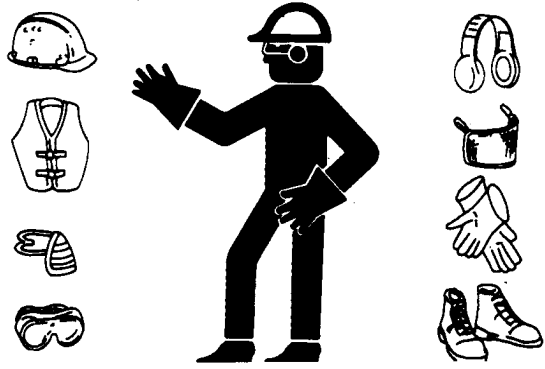

DX,WEAR -19-10SEP90

TS206 -UN-23AUG88

WORK IN CLEAN AREA

Before starting a job:

- Clean work area and machine.
- Make sure you have all necessary tools to do your job.
- Have the right parts on hand.
- Read all instructions thoroughly; do not attempt shortcuts.

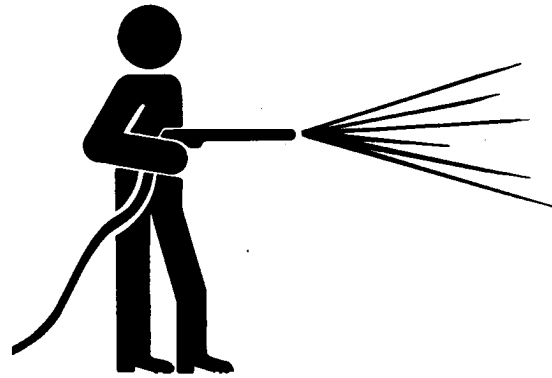

DX,CLEAN -19-04JUN90

T6642EJ -UN-18OCT88

SERVICE MACHINES SAFELY

Tie long hair behind your head. Do not wear a necktie, scarf, loose clothing, or necklace when you work near machine tools or moving parts. If these items were to get caught, severe injury could result.

Remove rings and other jewelry to prevent electrical shorts and entanglement in moving parts.

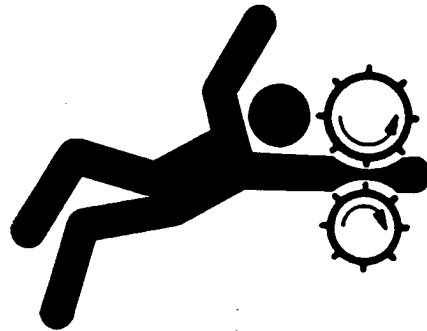

DX,LOOSE -19-04JUN90

TS228 -UN-23AUG88

WORK IN VENTILATED AREA

Engine exhaust fumes can cause sickness or death. If it is necessary to run an engine in an enclosed area, remove the exhaust fumes from the area with an exhaust pipe extension.

If you do not have an exhaust pipe extension, open the doors and get outside air into the area.



DX,AIR -19-04JUN90

TS220 -UN-23AUG88

ILLUMINATE WORK AREA SAFELY

Illuminate your work area adequately but safely. Use a portable safety light for working inside or under the machine. Make sure the bulb is enclosed by a wire cage. The hot filament of an accidentally broken bulb can ignite spilled fuel or oil.

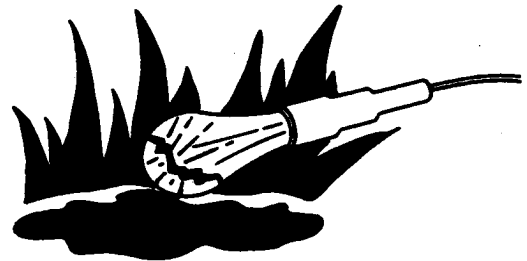

DX,LIGHT -19-04JUN90

TS223 -UN-23AUG88

REPLACE SAFETY SIGNS

Replace missing or damaged safety signs. See the machine operator's manual for correct safety sign placement.



DX,SIGNS1 -19-04JUN90

TS201 -UN-23AUG88

USE PROPER LIFTING EQUIPMENT

Lifting heavy components incorrectly can cause severe injury or machine damage.

Follow recommended procedure for removal and installation of components in the manual.

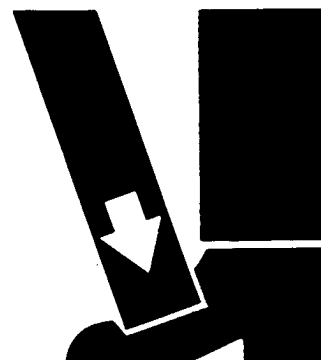

DX,LIFT -19-04JUN90

TS226 -UN-23AUG88

10
05
8

REMOVE PAINT BEFORE WELDING OR HEATING

Avoid potentially toxic fumes and dust.

Hazardous fumes can be generated when paint is heated by welding, soldering, or using a torch.

Do all work outside or in a well ventilated area. Dispose of paint and solvent properly.

Remove paint before welding or heating:

- If you sand or grind paint, avoid breathing the dust. Wear an approved respirator.
- If you use solvent or paint stripper, remove stripper with soap and water before welding. Remove solvent or paint stripper containers and other flammable material from area. Allow fumes to disperse at least 15 minutes before welding or heating.



TS220 -UN-23AUG88

DX,PAINT -19-03MAR93

AVOID HEATING NEAR PRESSURIZED FLUID LINES

Flammable spray can be generated by heating near pressurized fluid lines, resulting in severe burns to yourself and bystanders. Do not heat by welding, soldering, or using a torch near pressurized fluid lines or other flammable materials. Pressurized lines can be accidentally cut when heat goes beyond the immediate flame area.



TS953 -UN-15MAY90

DX,TORCH -19-03MAR93

SERVICE TIRES SAFELY

Explosive separation of a tire and rim parts can cause serious injury or death.

Do not attempt to mount a tire unless you have the proper equipment and experience to perform the job.

Always maintain the correct tire pressure. Do not inflate the tires above the recommended pressure. Never weld or heat a wheel and tire assembly. The heat can cause an increase in air pressure resulting in a tire explosion. Welding can structurally weaken or deform the wheel.

When inflating tires, use a clip-on chuck and extension hose long enough to allow you to stand to one side and NOT in front of or over the tire assembly. Use a safety cage if available.

Check wheels for low pressure, cuts, bubbles, damaged rims or missing lug bolts and nuts.



DX,TIRECP -19-24AUG90

9510
-UN-12APR90
TS952

AVOID HARMFUL ASBESTOS DUST

Avoid breathing dust that may be generated when handling components containing asbestos fibers. Inhaled asbestos fibers may cause lung cancer.

Components in products that may contain asbestos fibers are brake pads, brake band and lining assemblies, clutch plates, and some gaskets. The asbestos used in these components is usually found in a resin or sealed in some way. Normal handling is not hazardous as long as airborne dust containing asbestos is not generated.

Avoid creating dust. Never use compressed air for cleaning. Avoid brushing or grinding material containing asbestos. When servicing, wear an approved respirator. A special vacuum cleaner is recommended to clean asbestos. If not available, apply a mist of oil or water on the material containing asbestos.

Keep bystanders away from the area.

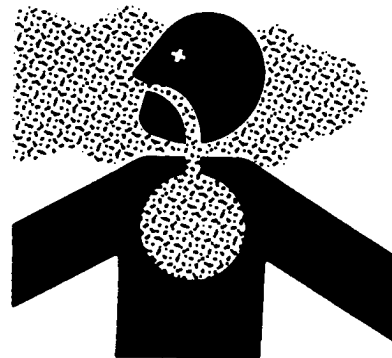

DX,DUST -19-15MAR91

-UN-23AUG88
TS220

10
05
10

PRACTICE SAFE MAINTENANCE

Understand service procedure before doing work. Keep area clean and dry.

Never lubricate, service, or adjust machine while it is moving. Keep hands, feet, and clothing from power-driven parts. Disengage all power and operate controls to relieve pressure. Lower equipment to the ground. Stop the engine. Remove the key. Allow machine to cool.

Securely support any machine elements that must be raised for service work.

Keep all parts in good condition and properly installed. Fix damage immediately. Replace worn or broken parts. Remove any buildup of grease, oil, or debris.

Disconnect battery ground cable (-) before making adjustments on electrical systems or welding on machine.



DX,SERV -19-03MAR93

TS218 -UN-23AUG88

USE PROPER TOOLS

Use tools appropriate to the work. Makeshift tools and procedures can create safety hazards.

Use power tools only to loosen threaded parts and fasteners.

For loosening and tightening hardware, use the correct size tools. DO NOT use U.S. measurement tools on metric fasteners. Avoid bodily injury caused by slipping wrenches.

Use only service parts meeting John Deere specifications.



DX,REPAIR -19-04JUN90

TS779 -UN-08NOV89

DISPOSE OF WASTE PROPERLY

Improperly disposing of waste can threaten the environment and ecology. Potentially harmful waste used with John Deere equipment include such items as oil, fuel, coolant, brake fluid, filters, and batteries.

Use leakproof containers when draining fluids. Do not use food or beverage containers that may mislead someone into drinking from them.

Do not pour waste onto the ground, down a drain, or into any water source.

Air conditioning refrigerants escaping into the air can damage the Earth's atmosphere. Government regulations may require a certified air conditioning service center to recover and recycle used air conditioning refrigerants.

Inquire on the proper way to recycle or dispose of waste from your local environmental or recycling center, or from your John Deere dealer.

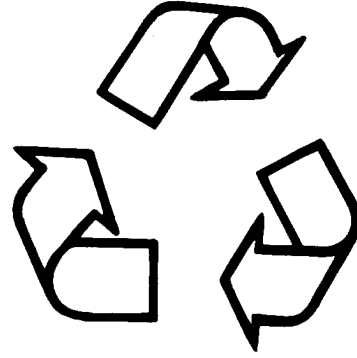

DX,DRAIN -19-03MAR93

TS1133 -JUN-26NOV90

10-05-11

LIVE WITH SAFETY

Before returning machine to customer, make sure machine is functioning properly, especially the safety systems. Install all guards and shields.



DX,LIVE -19-25SEP92

TS231 -19-07OCT88

MACHINE SPECIFICATIONS

	316	318	420
ENGINE			
Manufacturer	Onan	Onan	Onan
Type	Gasoline	Gasoline	Gasoline
Model Number			
Early	B43E	B43G	B48G
Later	P218G	P218G	P220G
Horsepower (SAEJ607)			
Early	11.9 kW (16 hp)	13.4 kW (18 hp)	14.9 kW (20 hp)
Later	13.4 kW (18 hp)	13.4 kW (18 hp)	14.9 kW (20 hp)
Torque	4.4 kg m (31.5 ft lbs)	4.4 kg m (31.5 ft lbs)	4.4 kg m (31.8 ft lbs)
Engine Rated Speeds			
Fast Idle (No Load)	3450 rpm	3450 rpm	3450 rpm
Low Idle (No Load)	1350 rpm	1350 rpm	1350 rpm
Number of Cylinders	2	2	2
Crankshaft Alignment	Horizontal	Horizontal	Horizontal
Stroke/Cycle	4 Cycle	4 Cycle	4 Cycle
Bore	82.55 mm (3.25 in.)	82.55 mm (3.25 in.)	82.55 mm (3.25 in.)
Stroke			
Early	66 mm (2.620 in.)	66 mm (2.620 in.)	73 mm (2.875 in.)
Later	73 mm (2.875 in.)	73 mm (2.875 in.)	73 mm (2.875 in.)
Displacement			
Early	710 cm ³ (43.3 cu in.)	710 cm ³ (43.3 cu in.)	782 cm ³ (47.7 cu in.)
Later	782 cm ³ (47.7 cu in.)	782 cm ³ (47.7 cu in.)	782 cm ³ (47.7 cu in.)
Compression Ratio			
Early	6.2:1	6.5:1	7.0:1
Later	7.0:1	7.0:1	7.0:1
Cylinder Material	Aluminum	Aluminum	Aluminum
Cooling	Air	Air	Air
Air Filter Type	Dry with Pre-Cleaner	Dry with Pre-Cleaner	Dry with Pre-Cleaner
Lubrication System	Full Pressure w/Filter	Full Pressure w/Filter	Full Pressure w/Filter
Crankcase Capacity (w/o Filter)	1.4 L (1.5 U.S. qt)	1.4 L (1.5 U.S. qt)	1.4 L (1.5 U.S. qt)
Oil Filter	Replaceable	Replaceable	Replaceable
Spark Plugs	NGK BPR5EFS Champion RS14YC	NGK BPR5EFS Champion RS14YC	NGK BPR5EFS Champion RS14YC
FUEL SYSTEM			
Fuel Tank Location	Rear	Rear	Rear
Fuel Gauge	Standard	Standard	Standard
Fuel Reserve System	N/A	Standard	Standard
Fuel Tank Capacity	17 L (4.5 U.S. gal)	17 L (4.5 U.S. gal)	25 L (6.5 U.S. gal)
Fuel (min. octane)	85 Octane Unleaded	85 Octane Unleaded	85 Octane Unleaded
Fuel Pump Location	Engine	Engine	Engine
Fuel Pump Type	Pulse	Pulse	Pulse
Fuel Delivery	Fixed Jet Carburetor	Fixed Jet Carburetor	Fixed Jet Carburetor
ELECTRICAL SYSTEM			
Ignition	Electronic	Electronic	Electronic
Type of Starter	12 Volts, Solenoid	12 Volts, Solenoid	12 Volts, Solenoid
Charging System	Early, 15 amp Stator Later, 20 amp Stator	20 amp Stator	20 amp Stator

Continued on next page.

MX,15901010,1 -19-25APR95

10
10
1

General Specifications/Machine Specifications

10
10-2

	316	318	420
ELECTRICAL SYSTEM, continued			
Battery Type	BCI Group 22F	BCI Group 22F	BCI Group 22F
Battery Voltage	12V	12V	12V
Battery Reserve Capacity @			
25 amp	102 minutes	102 minutes	102 minutes
Battery Cold Cranking amp @ 0°F	491 amp	491 amp	491 amp
Headlights	Standard	Standard	Standard
Rear Reflector/Tail Lights	Standard	Standard	Standard
Dash Indicator Lights	Standard	Standard	Standard
Operator Presence System	Standard	Standard	Standard
Dash Instrumentation			
Hourmeter	Standard	Standard	Standard
POWER TRAIN			
Transmission Type	Hydrostatic	Hydrostatic	Hydrostatic, 2 Ranges
Number of Speeds	Infinite	Infinite	Infinite
Travel Speeds			
Forward	0—12.38 km/h (0—7.69 mph)	0—12.38 km/h (0—7.69 mph)	N/A
Reverse	0—6.19 km/h (0—3.85 mph)	0—6.19 km/h (0—3.85 mph)	N/A
Forward, High	N/A	N/A	0—15.04 km/h (0—9.35 mph)
Forward, Low	N/A	N/A	0—9.35 km/h (0—5.80 mph)
Reverse, High	N/A	N/A	0—7.52 km/h (0—4.67 mph)
Reverse, Low	N/A	N/A	0—4.66 km/h (0—2.90 mph)
Transmission Capacity w/Filter	6.1 L (13 U.S. pt)	7.1 L (15 U.S. pt)	7.1 L (15 U.S. pt)
Transmission Oil Cooler	N/A	Standard	Standard
Transmission Oil Filter	Standard	Standard	Standard
Differential Lock	N/A	N/A	Standard
STEERING			
Type	Manual	Power, Hydrostatic	Power, Hydrostatic
BRAKES			
Location	Rear Wheels	Rear Wheels	Rear Wheels
Individually Controlled	N/A	Standard	Standard
Type	Shoe and Drum	Shoe and Drum	Shoe and Drum
Return-to-Neutral Braking	Standard	Standard	Standard
Parking	Yes	Yes	Yes
HYDRAULIC SYSTEM			
Type	Single-Function	Two-Function (One w/Float)	Three-Function (One w/Float)
Hydraulic Couplers	One Set	Two Sets	Two Sets

Continued on next page.

MX,15901010,2 -19-25APR95

General Specifications/Machine Specifications

	316	318	420
PTO			
Front	Standard	Standard	Standard
Rear	Optional	Optional	Optional
Type	Electric Clutch	Electric Clutch	Electric Clutch
Control	Elec. Switch on Dash	Elec. Switch on Dash	Elec. Switch on Dash
PTO rpm (No Load)			
Front	3450	3450	3450
Rear	2000	2000	2000
MOWER ATTACHMENT			
Compatibility	38, 46 and 50 Inch	38, 46 and 50 Inch	50 and 60 Inch 260 Rotary
Lift System	Hydraulic	Hydraulic	Hydraulic
WHEEL TREAD			
Front	813 mm (32 in.)	813 mm (32 in.)	914 mm (36 in.)
Rear			
Narrow	775 mm (30.5 in.)	775 mm (30.5 in.)	818 mm (32 in.)
Wide	834 mm (32.8 in.)	834 mm (32.8 in.)	980 mm (38.6 in.)
TIRES			
Standard Tires			
Front Turf	16 x 6.50-8, 2 PR	16 x 6.50-8, 2 PR	18 x 8.50-8, 4 PR
Rear Turf or Bar	23 x 10.50-12, 2 PR	23 x 10.50-12, 2 PR	26 x 12.00-12, 2 PR
Optional Tires			
Front (Turf)	16 x 6.50-8, 4 PR	16 x 6.50-8, 4 PR	N/A
Rear (Turf or Bar)	23 x 8.50-12, 2 PR	23 x 8.50-12, 2 PR	N/A
Inflation Pressure			
Front	41—110 kPa (6—16 psi)	41—110 kPa (6—16 psi)	41—152 kPa (6—22 psi)
Rear	34—69 kPa (5—10 psi)	34—69 kPa (5—10 psi)	34—69 kPa (5—10 psi)
SEAT			
Style	High-Back	High-Back	High-Back
Suspension	2 Spring	2 Spring	2 Spring
Adjustment	Slide Rail	Slide Rail	Slide Rail
DIMENSIONS			
Wheel Base	1.2 m (46 in.)	1.2 m (46 in.)	1.3 m (52 in.)
Overall Length	1.8 m (69.5 in.)	1.8 m (69.5 in.)	2.0 m (77 in.)
Overall Height	1.1 m (44.5 in.)	1.1 m (44.5 in.)	1.21 m (47.5 in.)
Overall Width (max.)	1.1 m (43.3 in.)	1.1 m (43.3 in.)	1.31 m (51.5 in.)
Overall Width (min.)	1.04 m (41 in.)	1.04 m (41 in.)	1.14 m (45 in.)
Turning Radius			
Inside Rear Wheel	660 mm (26 in.)	660 mm (26 in.)	660 mm (26 in.)
Outside Front Wheel	2.0 m (80 in.)	2.0 m (80 in.)	2.2 m (86 in.)
NET WEIGHT (No Fuel)	354 kg (780 lbs)	354 kg (780 lbs)	408 kg (913 lbs)
SHIPPING WEIGHT	386 kg (852 lbs)	386 kg (852 lbs)	450 kg (993 lbs)

(Specifications and design subject to change without notice.)

MX,15901010,3 -19-25APR95

10
10
3

REPAIR SPECIFICATIONS

Item	Specifications
ENGINE	
For all repair specifications—Use CTM2	
Engine Mounting Cap Screw/Nut Torque	
316	39 N·m (29 lb-ft)
318 and 420	47 N·m (34 lb-ft)
Drive Shaft-to-Engine Cap Screw Torque	27 N·m (20 lb-ft)
PTO Belt Tension Spring Length (420)	
Horizontal Adjuster (Early)	41 mm (1.600 in.)
Vertical Adjuster (Later)	35 mm (1.380 in.)
ELECTRICAL	
Front PTO Clutch-to-Crankshaft Cap Screw Torque	47 N·m (35 lb-ft)
PTO Clutch Armature-to-Rotor Clearance	0.46 mm (0.018 in.)
PTO Belt Tension Spring Length (420)	
Horizontal Adjuster (Early)	41 mm (1.600 in.)
Vertical Adjuster (Later)	35 mm (1.380 in.)
POWER TRAIN	
Transmission	
Charge Pump-to-Transmission Cap Screw Torque	70 N·m (52 lb-ft)
Transmission Cover Bearing Installation Height	3 mm (0.118 in.) above housing surface
Center Section-to-Housing Cap Screw Torque	35 N·m (26 lb-ft)
Transmission-to-Differential Cap Screw Torque	45 N·m (33 lb-ft)
Axle Housing-to-Frame Cap Screw Torque	100 N·m (75 lb-ft)
Brake Rod Spring Length	42 mm (1.650 in.)
Differential-to-Frame Support Cap Screw Torque	61 N·m (45 lb-ft)
Swashplate Control Arm-to-Control Shaft Nut Torque	60 N·m (44 lb-ft)
Drive Shaft Clamping Yoke-to-Transmission Pump Shaft Cap Screw Torque	60 N·m (44 lb-ft)
Differential	
Case and Cover Oil Groove Depth (Minimum)	0.25 mm (0.010 in.)
Carrier Cap Screw Torque	53 N·m (39 lb-ft)
Cover-to-Case Cap Screw Torque	23 N·m (20 lb-in.)
Axle Housing	
Differential Seal Depth	3 mm (0.118 in.)
Axle Housing-to-Differential Cap Screw Torque	81 N·m (60 lb-ft)
Brake Plate-to-Axle Housing Cap Screw Torque	68 N·m (50 lb-ft)
Axle Housing-to-Frame Cap Screw Torque	100 N·m (75 lb-ft)
Brake Rod Spring Length	42 mm (1.650 in.)
Brake Drum-to-Axle Nut Torque	88 N·m (65 lb-ft)
Rear Wheel Cap Screw Torque	70 N·m (52 lb-ft)
Drive Shaft	
Drive Shaft-to-Engine Cap Screw Torque	27 N·m (20 lb-ft)
Clamping Yoke-to-Transmission Pump Shaft Cap Screw Torque	60 N·m (44 lb-ft)

Continued on next page.

MX,15901015,1 -19-08MAY95

Item	Specifications
STEERING AND BRAKES	
Steering—316	
Gearbox Mounting Cap Screw Torque	95 N·m (70 lb-ft)
Steering Wheel-to-Shaft Nut Torque	15 N·m (133 lb-in.)
Pitman Arm Nut Torque	224 N·m (165 lb-ft)
Preload Adjuster Maximum End Clearance	0.05 mm (0.002 in.)
Side Cover-to-Gearbox Housing Cap Screw Torque	40 N·m (30 lb-ft)
Worm Bearing Preload Rolling Torque	0.60—1.0 N·m (5—8 lb-in.)
Over-Center Preload Rolling Torque	0.50—1.20 N·m (4—10 lb-in.)
Preload Adjuster Lock Nut Torque	34 N·m (25 lb-ft)
Steering Shaft Universal Joint-to-Worm Shaft Cap Screw Torque	24 N·m (212 lb-in.)
Steering—318 and 420	
Steering Wheel-to-Shaft Nut Torque	15 N·m (133 lb-in.)
Rotor-to-Stator Maximum Allowable Clearance	0.08 mm (0.003 in.)
Steering Tube Bushing Depth	2.5 mm (0.100 in.) below top of tube
Commutator Cover-to-Commutator Screw Torque	1.4 N·m (12 lb-in.)
Port Cover Nut Torque	30 N·m (22 lb-ft)
Check Ball Plug Torque (Early Version)	14 N·m (124 lb-in.)
Steering Cylinder Mounting Nut Torque	163 N·m (120 lb-ft)
Brakes	
Brake Plate-to-Axle Housing Cap Screw Torque	68 N·m (50 lb-ft)
Axle Housing-to-Frame Cap Screw Torque	100 N·m (75 lb-ft)
Brake Rod Spring Length	42 mm (1.650 in.)
Brake Drum-to-Axle Nut Torque	88 N·m (65 lb-ft)
Rear Wheel Cap Screw Torque	70 N·m (52 lb-ft)
HYDRAULICS	
Single-Spool Valve	
Spool Screw Torque	4 N·m (35 lb-in.)
Spool Cap-to-Body Screw Torque	4 N·m (35 lb-in.)
Check Valve Plug Torque	31 N·m (23 lb-ft)
Two-Spool Valve	
Versions One, Two and Three	
Spool Cap-to-Body Screw Torque	31 N·m (23 lb-ft)
Versions Four and Five	
Spool Screw and Detent Torque	4 N·m (35 lb-in.)
Spool Cap-to-Body Screw Torque	4 N·m (35 lb-in.)
Check Valve Plug Torque	31 N·m (23 lb-ft)
Three-Spool Valve	
Versions One, Two and Three	
Spool Cap-to-Body Screw Torque	31 N·m (23 lb-ft)
Lock Nut Torque (Version Three)	31 N·m (23 lb-ft)
Version Four	
Spool Screws and Detent Torque	4 N·m (35 lb-in.)
Spool Cap-to-Body Screw Torque	4 N·m (35 lb-in.)
Check Valve Plug Torque	31 N·m (23 lb-ft)

Continued on next page.

MX,15901015,2 -19-08MAY95

Item	Specifications
MISCELLANEOUS	
Front Axle	
PTO Belt Tension Spring Length (420)	
Horizontal Adjuster (Early)	41 mm (1.600 in.)
Vertical Adjuster (Later)	35 mm (1.380 in.)
Toe-In	4.8 mm (3/16 in.)
Mower Blade Spindles	
Driven Sheave-to-Spindle Lock Nut Torque	140 N·m (103 lb-ft)
Blade-to-Spindle Cap Screw Torque	73 N·m (54 lb-ft)
Mower Blade Jack Sheave	
Jack Sheave-to-Spindle Lock Nut Torque	140 N·m (103 lb-ft)
Blade-to-Spindle Cap Screw Torque	73 N·m (54 lb-ft)
50-Inch Mower Gear Case	
Plug Installation Depth	1.59 mm (0.062 in.) below gear case surface
Retainer Seal Installation Depth	2.54 mm (0.100 in.) below retainer surface
Retainer-to-Gear Case Cap Screw Torque	30 N·m (22 lb-ft)
Pillow Block Seal Installation Depth	2.54 mm (0.100 in.) below block surface
Pillow Block-to-Gear Case Cap Screw Torque	30 N·m (22 lb-ft)
Early 60-Inch Mower Gear Case	
Cap-to-Gear Case Cap Screw Torque	30 N·m (22 lb-ft)
Output Shaft Endplay	0.025—0.076 mm (0.001—0.003 in.)
Input Shaft Backlash	0.076—0.130 mm (0.003—0.005 in.)
Later 60-Inch Mower Gear Case	
Gear Case Seal Installation Depth	2.54 mm (0.100 in.) below gear case surface
Retainer-to-Gear Case Cap Screw Torque	30 N·m (22 lb-ft)
Pillow Block Seal Installation Depth	2.54 mm (0.100 in.) below block surface
Pillow Block-to-Gear Case Cap Screw Torque	30 N·m (22 lb-ft)
260 Rotary Mower Gear Case	
End Cap-to-Gear Case Cap Screw Torque	30 N·m (22 lb-ft)
Input Shaft Endplay	0.025—0.076 mm (0.001—0.003 in.)
Output Shaft Backlash	0.076—0.130 mm (0.003—0.005 in.)
Housing-to-Gear Case Cap Screw Torque	30 N·m (22 lb-ft)

MX,15901015,6 -19-20MAR95

METRIC BOLT AND CAP SCREW TORQUE VALUES

10
15
4

TS1163 -19-04/MAR91

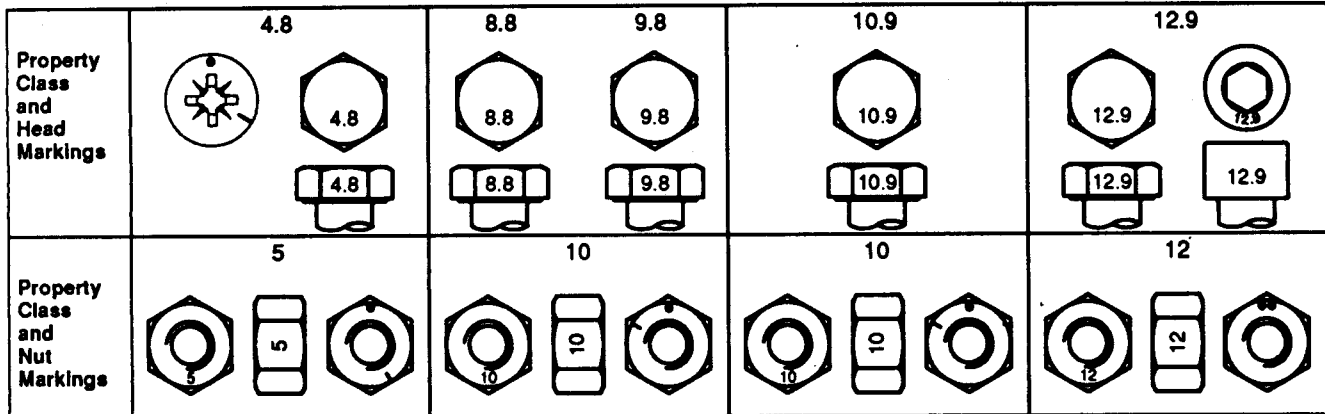

Size	Class 4.8				Class 8.8 or 9.8				Class 10.9				Class 12.9			
	Lubricated ^a		Dry ^a		Lubricated ^a		Dry ^a		Lubricated ^a		Dry ^a		Lubricated ^a		Dry ^a	
	N-m	lb-ft	N-m	lb-ft	N-m	lb-ft	N-m	lb-ft	N-m	lb-ft	N-m	lb-ft	N-m	lb-ft	N-m	lb-ft
M6	4.8	3.5	6	4.5	9	6.5	11	8.5	13	9.5	17	12	15	11.5	19	14.5
M8	12	8.5	15	11	22	16	28	20	32	24	40	30	37	28	47	35
M10	23	17	29	21	43	32	55	40	63	47	80	60	75	55	95	70
M12	40	29	50	37	75	55	95	70	110	80	140	105	130	95	165	120
M14	63	47	80	60	120	88	150	110	175	130	225	165	205	150	260	190
M16	100	73	125	92	190	140	240	175	275	200	350	255	320	240	400	300
M18	135	100	175	125	260	195	330	250	375	275	475	350	440	325	560	410
M20	190	140	240	180	375	275	475	350	530	400	675	500	625	460	800	580
M22	260	190	330	250	510	375	650	475	725	540	925	675	850	625	1075	800
M24	330	250	425	310	650	475	825	600	925	675	1150	850	1075	800	1350	1000
M27	490	360	625	450	950	700	1200	875	1350	1000	1700	1250	1600	1150	2000	1500
M30	675	490	850	625	1300	950	1650	1200	1850	1350	2300	1700	2150	1600	2700	2000
M33	900	675	1150	850	1750	1300	2200	1650	2500	1850	3150	2350	2900	2150	3700	2750
M36	1150	850	1450	1075	2250	1650	2850	2100	3200	2350	4050	3000	3750	2750	4750	3500

DO NOT use these values if a different torque value or tightening procedure is given for a specific application. Torque values listed are for general use only. Check tightness of fasteners periodically.

Shear bolts are designed to fail under predetermined loads. Always replace shear bolts with identical property class.

Fasteners should be replaced with the same or higher property class. If higher property class fasteners are used, these should only be tightened to the strength of the original.

^a "Lubricated" means coated with a lubricant such as engine oil, or fasteners with phosphate and oil coatings. "Dry" means plain or zinc plated without any lubrication.

Make sure fasteners threads are clean and that you properly start thread engagement. This will prevent them from failing when tightening.

Tighten plastic insert or crimped steel-type lock nuts to approximately 50 percent of the dry torque shown in the chart, applied to the nut, not to the bolt head. Tighten toothed or serrated-type lock nuts to the full torque value.

UNIFIED INCH BOLT AND CAP SCREW TORQUE VALUES

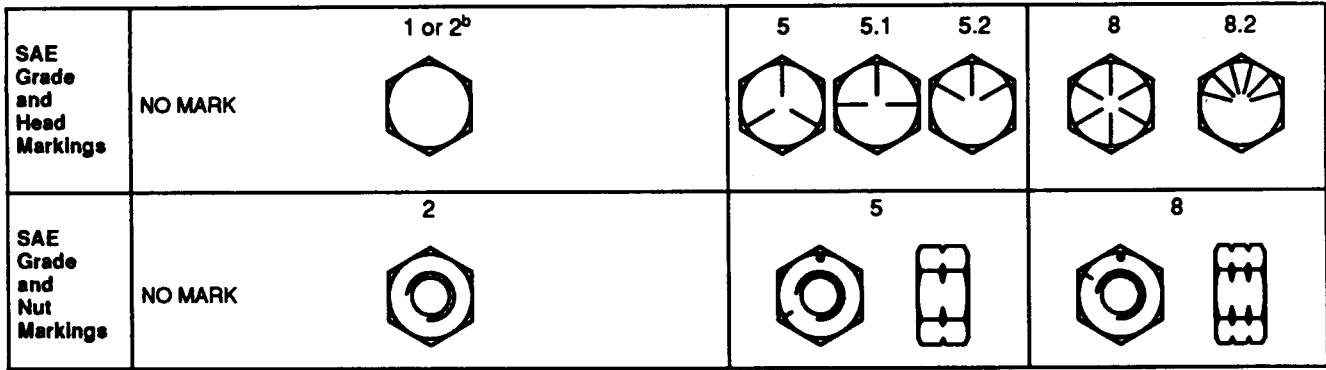

Size	Grade 1				Grade 2 ^b				Grade 5, 5.1, or 5.2				Grade 8 or 8.2			
	Lubricated ^a		Dry ^a		Lubricated ^a		Dry ^a		Lubricated ^a		Dry ^a		Lubricated ^a		Dry ^a	
	N-m	lb-ft	N-m	lb-ft	N-m	lb-ft	N-m	lb-ft	N-m	lb-ft	N-m	lb-ft	N-m	lb-ft	N-m	lb-ft
1/4	3.7	2.8	4.7	3.5	6	4.5	7.5	5.5	9.5	7	12	9	13.5	10	17	12.5
5/16	7.7	5.5	10	7	12	9	15	11	20	15	25	18	28	21	35	26
3/8	14	10	17	13	22	16	27	20	35	26	44	33	50	36	63	46
7/16	22	16	28	20	35	26	44	32	55	41	70	52	80	58	100	75
1/2	33	25	42	31	53	39	67	50	85	63	110	80	120	90	150	115
9/16	48	36	60	45	75	56	95	70	125	90	155	115	175	130	225	160
5/8	67	50	85	62	105	78	135	100	170	125	215	160	240	175	300	225
3/4	120	87	150	110	190	140	240	175	300	225	375	280	425	310	550	400
7/8	190	140	240	175	190	140	240	175	490	360	625	450	700	500	875	650
1	290	210	360	270	290	210	360	270	725	540	925	675	1050	750	1300	975
1-1/8	400	300	510	375	400	300	510	375	900	675	1150	850	1450	1075	1850	1350
1-1/4	570	425	725	530	570	425	725	530	1300	950	1650	1200	2050	1500	2600	1950
1-3/8	750	550	950	700	750	550	950	700	1700	1250	2150	1550	2700	2000	3400	2550
1-1/2	1000	725	1250	925	990	725	1250	930	2250	1650	2850	2100	3600	2650	4550	3350

DO NOT use these values if a different torque value or tightening procedure is given for a specific application. Torque values listed are for general use only. Check tightness of fasteners periodically.

Shear bolts are designed to fail under predetermined loads. Always replace shear bolts with identical grade.

^a "Lubricated" means coated with a lubricant such as engine oil, or fasteners with phosphate and oil coatings. "Dry" means plain or zinc plated without any lubrication.

^b Grade 2 applies for hex cap screws (not hex bolts) up to 152 mm (6-in.) long. Grade 1 applies for hex cap screws over 152 mm (6-in.) long, and for all other types of bolts and screws of any length.

Fasteners should be replaced with the same or higher grade. If higher grade fasteners are used, these should only be tightened to the strength of the original.

Make sure fasteners threads are clean and that you properly start thread engagement. This will prevent them from failing when tightening.

Tighten plastic insert or crimped steel-type lock nuts to approximately 50 percent of the dry torque shown in the chart, applied to the nut, not to the bolt head. Tighten toothed or serrated-type lock nuts to the full torque value.

METRIC CAP SCREW TORQUE VALUES—GRADE 7

NOTE: When bolting aluminum parts, tighten to 80% of torque specified in table.

Size	N-m	(lb-ft)
M6	9.5 - 12.2	(7-9)
M8	20.3 - 27.1	(15-20)
M10	47.5 - 54.2	(35-40)
M12	81.4 - 94.9	(60-70)
M14	128.8 - 146.4	(95-108)
M16	210.2 - 240	(155-177)

MX,15901015,3 -19-01MAR95

SET SCREW SEATING TORQUE CHART

Screw Size	Cup Point	Square Head
Torque in Inch Pounds		
#5	(1.02 N-m) 9	—
#6	(1.02 N-m) 9	—
#8	(2.26 N-m) 20	—
#10	(3.73 N-m) 33	—
1/4	(9.83 N-m) 87	(23.96 N-m) 212
5/16	(18.65 N-m) 165	(47.46 N-m) 420
3/8	(32.77 N-m) 290	(93.79 N-m) 830
7/16	(48.59 N-m) 430	—
1/2	(70.06 N-m) 620	(237.30 N-m) 2100
9/16	(70.06 N-m) 620	—
5/8	(138.43 N-m) 1225	(480.25 N-m) 4250
3/4	(240.13 N-m) 2125	(870.10 N-m) 7700

NOTE: Allow a tolerance of plus or minus 10 per cent on all torques given in this chart.

Divide readings by 12 for foot-pound values.

MX,TORQ,SET -19-09DEC94

M77900 -19-15DEC94

SERVICE RECOMMENDATIONS FOR O-RING BOSS FITTINGS

STRAIGHT FITTING

1. Inspect O-ring boss seat for dirt or defects.
2. Lubricate O-ring with petroleum jelly. Place electrical tape over threads to protect O-ring. Slide O-ring over tape and into O-ring groove of fitting. Remove tape.
3. Tighten fitting to torque value shown on chart.

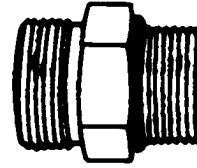

ANGLE FITTING

1. Back-off lock nut (A) and back-up washer (B) completely to head-end (C) of fitting.
2. Turn fitting into threaded boss until back-up washer contacts face of boss.
3. Turn fitting head-end counterclockwise to proper index (maximum of one turn).
4. Hold fitting head-end with a wrench and tighten locknut and back-up washer to proper torque value.

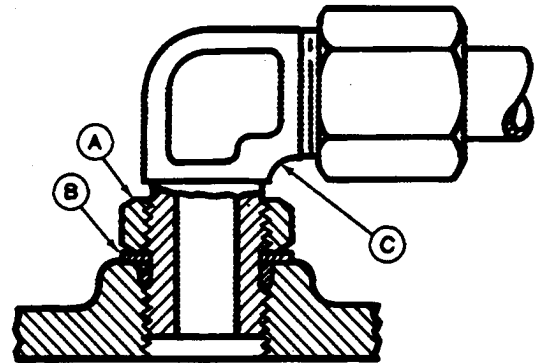

NOTE: Do not allow hoses to twist when tightening fittings.

TORQUE VALUE

Thread Size	N-m	lb-ft
3/8-24 UNF	8	6
7/16-20 UNF	12	9
1/2-20 UNF	16	12
9/16-18 UNF	24	18
3/4-16 UNF	46	34
7/8-14 UNF	62	46
1-1/16-12 UN	102	75
1-3/16-12 UN	122	90
1-5/16-12 UN	142	105
1-5/8-12 UN	190	140
1-7/8-12 UN	217	160

NOTE: Torque tolerance is $\pm 10\%$.

04T.90,K66 -19-01AUG94

10
15
7
-UN-18OCT88
T6249AE
-UN-18OCT88
T6520AB

SERVICE RECOMMENDATIONS FOR FLAT FACE O-RING SEAL FITTINGS

1. Inspect the fitting sealing surfaces. They must be free of dirt or defects.
2. Inspect the O-ring. It must be free of damage or defects.
3. Lubricate O-rings and install into groove using petroleum jelly to hold in place.
4. Push O-ring into the groove with plenty of petroleum jelly so O-ring is not displaced during assembly.
5. Index angle fittings and tighten by hand pressing joint together to insure O-ring remains in place.
6. Tighten fitting or nut to torque valve shown on the chart per dash size stamped on the fitting. Do not allow hoses to twist when tightening fittings.

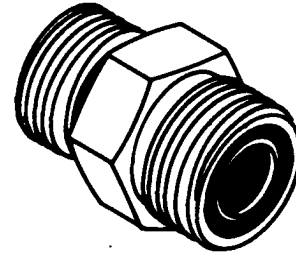

T6249AD -JUN-18OCT88

FLAT FACE O-RING SEAL FITTING TORQUE

Nominal Tube mm	O.D. (in.)	Dash Size	Thread Size In.	Swivel Nut Torque		Bulkhead Nut Torque	
				N-m	(lb-ft)	N-m	(lb-ft)
6.35	0.250	-4	9/16-18	16	12	5.0	3.5
9.52	0.375	-6	11/16-16	24	18	9.0	6.5
12.70	0.500	-8	13/16-16	50	37	17.0	12.5
15.88	0.625	-10	1-14	69	51	17.0	12.5
19.05	0.750	-12	1 3/16-12	102	75	17.0	12.5
22.22	0.875	-14	1 3/16-12	102	75	17.0	12.5
25.40	1.000	-16	1 7/16-12	142	105	17.0	12.5
31.75	1.250	-20	1 11/16-12	190	140	17.0	12.5
38.10	1.500	-24	2-12	217	160	17.0	12.5

NOTE: Torque tolerance is +15 -20%.

OR,SEAL,FIT -19-03MAR89

TUBE AND HOSE FITTING, 37° FLARE AND 30° CONE SEAT CONNECTOR SERVICE RECOMMENDATIONS

1. Inspect the flare and the flare seat. They must be free of dirt and defects. If repeated leaks occur, inspect for defects with a magnifying glass. If burrs and raised nicks on the connector body cannot be removed with a slip stone, replace the connector.
2. Defects in the tube flare cannot be repaired. Replace the tube. Overtightening a defective flared fitting will not stop leaks.
3. As a field repair, a ductile truncated cone shaped washer can be used between the tube flare and connector body. These washers are soft enough to fill defects in the seat and flare. They will also seal the connection. Ductile washers are available from industrial supply houses.
4. Align the tube with the fitting before attempting to start the nut. Failure to do so can cause a deformed flare and subsequent leaks. Install hoses without twists. A twisted hose attempts to straighten out when pressure is applied. This exerts a torque on the connection, eventually causing failure.
5. Lubricate the connection with hydraulic fluid, petroleum jelly or soap. Tighten the swivel nut by hand until it is snug.
6. Mark a line across the nut and connector body. This line will serve as a visual indicator as to whether the nut has been tightened and by how much.
7. Using two wrenches, one on the connector body and a torque wrench on the nut, tighten the nut to the torque value as shown in the chart. In the case of a hose, it may be necessary to use three wrenches to prevent twisting.

MX,15901015,4 -19-17JAN95

10
15
9

TUBE AND HOSE FITTING, 37° FLARE AND 30° CONE SEAT CONNECTOR TORQUE

Thread Size	N·m	Torque ¹ (lb-ft)	New ² Number of Flats	Used ³ Number of Flats
3/8-24 UNF	8	(6)	2-1/2	1
7/16-20 UNF	12	(9)	2-1/2	1
1/2-20 UNF	16	(12)	2-1/2	1
9/16-18 UNF	24	(18)	2	1
3/4-16 UNF	46	(34)	2	1
7/8-14 UNF	62	(46)	1-1/2	1
1-1/16-12 UN	102	(75)	1	3/4
1-3/16-12 UN	122	(90)	1	3/4
1-5/16-12 UN	142	(105)	3/4	3/4
1-5/8-12 UN	190	(140)	3/4	3/4
1-7/8-12 UN	217	(160)	1/2	1/2

1. Tolerance of ± 10 percent.

2. To be used if a torque wrench cannot be used. After tightening fitting by hand, put a mark across the fittings, then tighten fitting the number of flats shown.

3. Flare connection seal by deforming or squeezing the tube between the nut and the connector. More deformation is possible with new parts than with old. Therefore, if a torque wrench is not used for re-assembly, the values in this column must be used to prevent damage.

MX,15901015,5 -19-17JAN95

TEST AND ADJUSTMENT SPECIFICATIONS

Item	Specifications
ENGINE	
Spark Plug Gap	0.64 mm (0.025 in.)
Slow Idle Speed	1350 rpm
Fast Idle Speed	3450 rpm
Dashpot-to-Governor Arm Bracket Clearance (B43E, B43G and B48G)	1.3 ± 0.2 mm (0.050 ± 0.010 in.)
Fuel Pump	
Minimum Fuel Flow	120 mL (4 oz)/30 seconds
Minimum Vacuum	9 kPa (2.6 in. mercury)
Minimum Fuel Pressure	12 kPa (1.7 psi)
Minimum Crankcase Vacuum	
B43E, B43G and B48G	25 cm (10 in.) Water
P218G and P220G	33 cm (13 in.) Water
Ignition Point Gap (B43E, B43G and B48G)	
B43E and B43G	0.41 mm (0.016 in.)
B48G	
Spec A and B	0.51 mm (0.020 in.)
Spec C	0.41 mm (0.016 in.)
Minimum Compression	
B43E, B43G and B48G	690 kPa (100 psi)
P218G, P220G	517 kPa (75 psi)
Maximum Difference Between Cylinders	69 kPa (10 psi)
Oil Pressure	
Slow Idle	69—103 kPa (10—15 psi)
Fast Idle	124—152 kPa (18—22 psi)
Oil Pressure Regulating Valve	
Cap Screw Thread Length	22 mm (0.875 in.)
Spring Free Length	25 mm (1 in.)
Spring Test Length	13 mm (0.500 in.) at 12 N (2.6 lbs force)
ELECTRICAL SYSTEM	
Ignition Point Gap (S.N. —420000)	
B43E and B43G	0.41 mm (0.016 in.)
B48G	
Spec A and B	0.51 mm (0.020 in.)
Spec C	0.41 mm (0.016 in.)
Ignition Coil Resistance with Coil Temperature at 20°C (68°F)	
(S.N. —420000)	
Primary Windings	3.9—4.7 ohms
Secondary Windings	12.6—15.4 K-ohms
(S.N. 420001—)	
Primary Windings	3.7—4.6 ohms
Secondary Windings	34.02—41.6 K-ohms
Starter (Bendix Type)	
316 (S.N. —362983), 318 (S.N. —364137), 420 (S.N. —360009)	
Current Draw (Maximum)	250 amps at 300 rpm cranking speed
No-Load rpm (Minimum)	5900 rpm
No-Load Amp Draw (Maximum)	30 amps

Continued on next page.

MX,15901020,1 -19-16MAY95

Test and Adjustment Specifications

10
20
2

Item	Specifications
ELECTRICAL SYSTEM, continued	
Starter (Solenoid Shift)	
316 (S.N. 362984—), 318 (S.N. 364138—), 420 (S.N. 360010—)	
Current Draw (Maximum)	250 amps at 300 rpm cranking speed
No-Load rpm (Minimum)	7000 rpm
No-Load Amp Draw (Maximum)	53 amps
Alternator	
Regulated Current Output	
316 (P218G), 318 and 420	20 amps
316 (B43E)	15 amps
Unregulated Output	
P218G and P220G	
Spec A	28—41 VAC
Spec B and C	28—57 VAC
B43E	28—40 VAC
B43G and B48G	28—31 VAC
Stator Resistance	
P218G and P220G	
Spec A	0.06—0.10 ohms
Spec B and C	0.10—0.19 ohms
B43E	0.10—0.20 ohms
B43G and B48G	0.30—0.50 ohms
PTO Clutch Armature-to-Rotor Clearance	0.46 mm (0.018 in.)
POWER TRAIN	
Oil Temperature for Hydraulic Tests	43°C (110°F)
Charge Pump Pressure	620—1240 kPa (90—180 psi)
Implement Relief Valve Pressure	5861—6722 kPa (850—975 psi)
Charge Pump Flow at 3450 kPa (500 psi)	11 L/min (3 gpm)
318 and 420; Steering Valve Pressure in Neutral Position	620—1240 kPa (90—180 psi)
Hydrostatic Lever Tension	31—44.5 N (7—10 lb force)
Turnbuckle Lock Nut Torque	
(Transmission Control Lever Linkage, Version One—All Models and Version Two—318)	
	33 N·m (24 lb-ft)
Detent Spring Length	
(Transmission Control Lever Linkage, Later Versions—All Models)	
	50 mm (1.970 in.)
STEERING AND BRAKES	
Oil Temperature for Hydraulic Tests	43°C (110°F)
Steering System Leakage Test at Slow Idle	
Torque Applied to Steering Wheel Nut	6.8 N·m (60 lb-in.)
Maximum Left and Right Turn rpm	6 rpm
HYDRAULIC SYSTEM	
Oil Temperature for Hydraulic Tests	43°C (110°F)
Control Valve Leakage Test	
Control Valve Pressure	5860—6550 kPa (850—950 psi)
Control Valve Leakage	15 mL/min (1/2 fl oz/min)

MX,15901020,2 -19-17MAY95

FUEL

N **CAUTION:** Handle fuel carefully. If the engine is hot or running, do not fill the fuel tank. Do not smoke while you fill the fuel tank or service the fuel system. Fill fuel tank only to bottom of filler neck.

IMPORTANT: DO NOT mix oil with gasoline.

1. Unleaded fuel is recommended. Regular leaded gasoline with an anti-knock index of 87 or higher may be used. Avoid switching from unleaded to regular gasoline to prevent engine damage.

Use of gasohol is acceptable as long as the ethyl alcohol blend does not exceed 10 percent. Unleaded gasohol is preferred over leaded gasohol.

2. Fill fuel tank at end of each day's operation. Fill fuel tank only to bottom of filler neck.



MX,15901025,1 -19-09DEC94

M33122
-JUN-25AUG88

10
25
1

STORING FUEL

If there is a very slow turnover of fuel in the fuel tank or supply tank, it may be necessary to add a fuel conditioner to prevent water condensation. Contact your John Deere dealer for proper service or maintenance recommendations.

DX,FUEL -19-03MAR93

ENGINE OIL

Use oil viscosity based on the expected air temperature range during the period between oil changes.

The following oils are preferred:

- John Deere TURF-GARD™
- John Deere PLUS-4®

Other oils may be used if they meet one or more of the following:

- API Service Classification SH
- API Service Classification SG
- CCMC Specification G5

Arctic oils (such as Military Specification MIL-L-46167B) may be used at temperature below -30°C (-22°F).

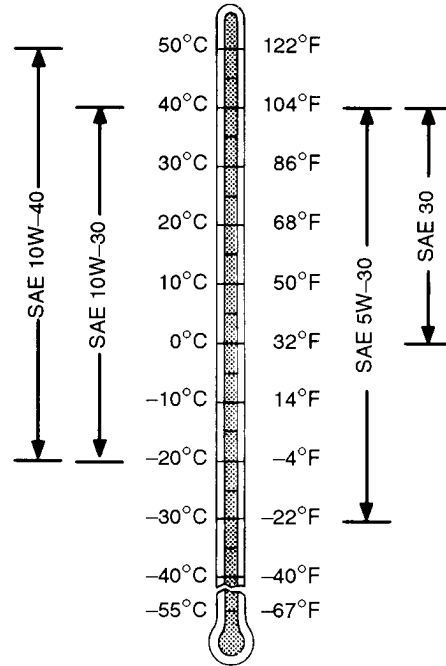

TS1624 -JUN-07NOV/94

MX,15901025,2 -19-09DEC94

TRANSMISSION AND HYDRAULIC OIL

Use oil viscosity based on the expected air temperature range during the period between oil changes.

The following oils are preferred:

- John Deere HY-GARD®
- John Deere Low Viscosity HY-GARD®

The following oils are also recommended:

- John Deere UNI-GARD™
- John Deere BIO-HY-GARD™¹

Other oils may be used if they meet one of the following:

- John Deere Standard JDM J20C
- John Deere Standard JDM J20D
- John Deere Standard JDM J27A

IMPORTANT: Do not use engine oil for this application.

Arctic oils (such as Military Specification MIL-L-46167B) may be used at temperatures below -30°C (-22°F).

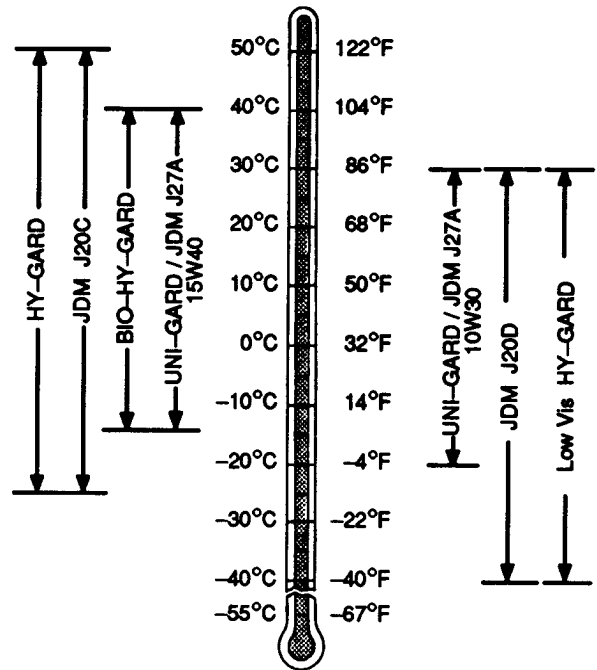

¹BIO-HY-GARD meets or exceeds the minimum biodegradability of 80% within 21 days according to CEC-L-33-T-82 test method. BIO-HY-GARD should not be mixed with mineral oils because this reduces the biodegradability and makes proper oil recycling impossible.

10
25
4

GREASE

Use grease based on the expected air temperature range during the service interval.

The following greases are preferred:

- John Deere MOLY HIGH TEMPERATURE EP GREASE
- John Deere HIGH TEMPERATURE EP GREASE
- John Deere GREASE-GARD™

Other greases may be used if they meet one of the following:

- SAE Multipurpose EP Grease with a maximum of 5% molybdenum disulfide
- SAE Multipurpose EP Grease

Greases meeting Military Specification MIL-G-10924F may be used as arctic grease.

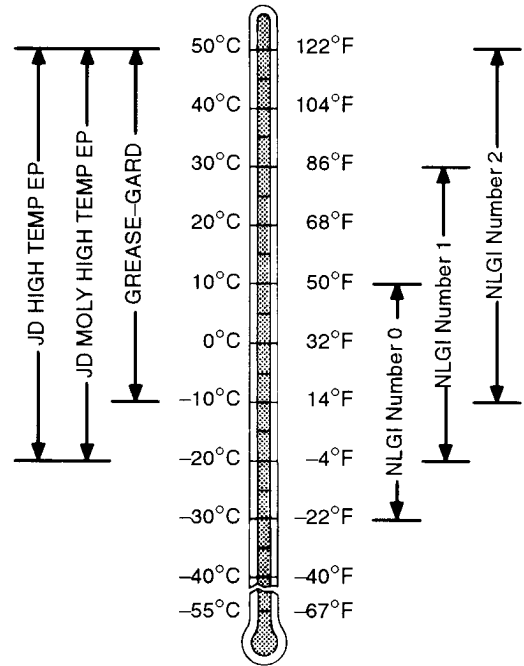

DX.GREA1 -19-02NOV94

TS1622 -UN-02NOV94

MOWER DECK GEAR CASE OIL

Depending upon the expected air temperature range during the drain interval, use oil viscosity shown on the adjoining temperature chart.

John Deere API GL-5 Gear Oil is recommended. If other oils are used, they must meet performance requirements of:

- API Service Classification GL-5
- Military Specification MIL-L-2105C

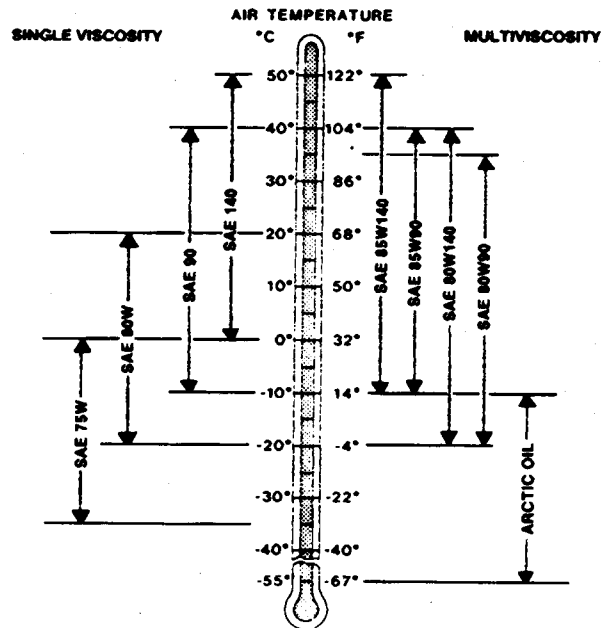

MX,15901025,3 -19-14FEB95

X9322 -19-30SEP88

ALTERNATIVE AND SYNTHETIC LUBRICANTS

Conditions in certain geographical areas may require lubricant recommendations different from those printed in this manual. Some John Deere lubricants may not be available in your location. Consult your John Deere dealer to obtain information and recommendations.

Synthetic lubricants may be used if they meet the performance requirements listed in this manual.

DX,ALTER -19-01FEB94

LUBRICANT STORAGE

Your equipment can operate at top efficiency only if clean lubricants are used.

Use clean containers to handle all lubricants.

Whenever possible, store lubricants and containers in an area protected from dust, moisture, and other contamination. Store containers on their side to avoid water and dirt accumulation.

DX,LUBST -19-01FEB94

MIXING OF LUBRICANTS

In general, avoid mixing different brands or types of oil. Oil manufacturers blend additives in their oils to meet certain specifications and performance requirements. Mixing different oils can interfere with the proper functioning of these additives and degrade lubricant performance.

DX,LUBMIX -19-01FEB94

SERIAL NUMBERS

When working on machines or components that are covered by warranty, it is IMPORTANT that you include the tractor Product Identification Number and the component serial number on the warranty claim form.

The location of component serial number plates are shown below.

MX,M21,1030R,1 -19-22APR85

PRODUCT IDENTIFICATION NUMBER

NOTE: All identification number plates are located on the pedestal. On some models, the plate is on the right-hand side. On others, front top left corner.



M34494
-UN-08NOV89

MX,15901030,1 -19-12MAY95

ENGINE SERIAL NUMBER



M77302
-UN-15DEC94

MX,15901030,2 -19-12MAY95

TRANSMISSION SERIAL NUMBER

Serial number plate (A) location.

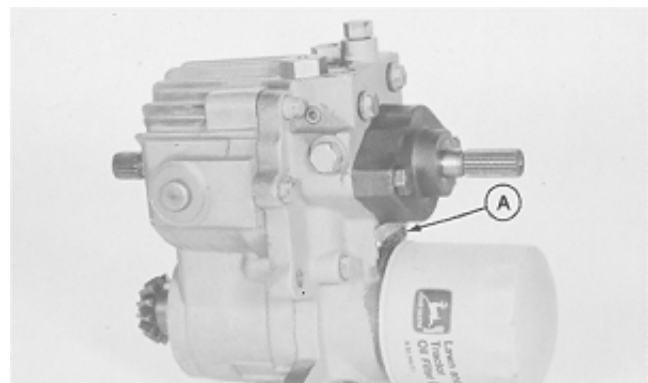

M38478
-UN-29AUG88

MX,15901030,3 -19-12MAY95

10
30
2

DIFFERENTIAL SERIAL NUMBER

Serial number plate (A) location.

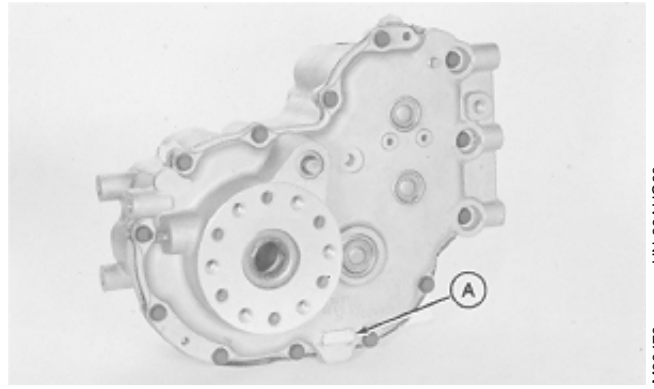

M38479 -UN-29AUG88

MX,15901030,4 -19-12MAY95

CONTROL VALVE SERIAL NUMBER

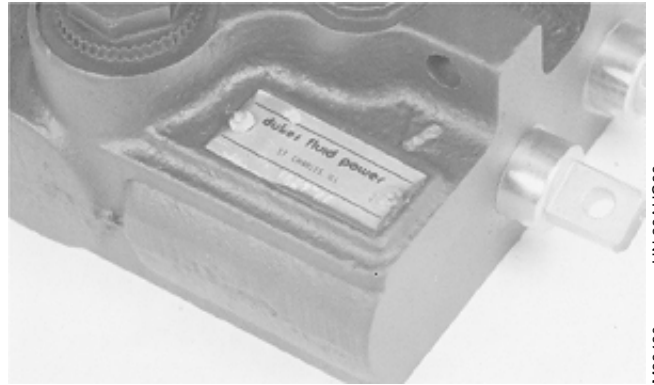

M38480 -UN-29AUG88

MX,15901030,5 -19-12MAY95

Section 20 ENGINE REPAIR

Contents

Page

Group 05—Engine

Repair—Use CTM2	20-05-1
Remove and Install	20-05-1

20



Suggest:

If the above button click is invalid.

Please download this document

first, and then click the above link

to download the complete manual.

Thank you so much for reading

ONAN ENGINE REPAIR—USE CTM2

For complete repair information, the component technical manual (CTM) is also required. Use the component technical manual in conjunction with this machine manual.



MX,15902005,1 -19-09DEC94

TS225

20-05-1

REMOVE AND INSTALL ENGINE

1. Disconnect battery negative (—) cable.
2. Disconnect headlight lead and headlight ground.
3. Remove grille, side panels, hood, hood support and air cleaner.
4. Disconnect items (A—C).

A—Fuel Pump Inlet Line
B—Regulator/Coil Lead
C—PTO Lead

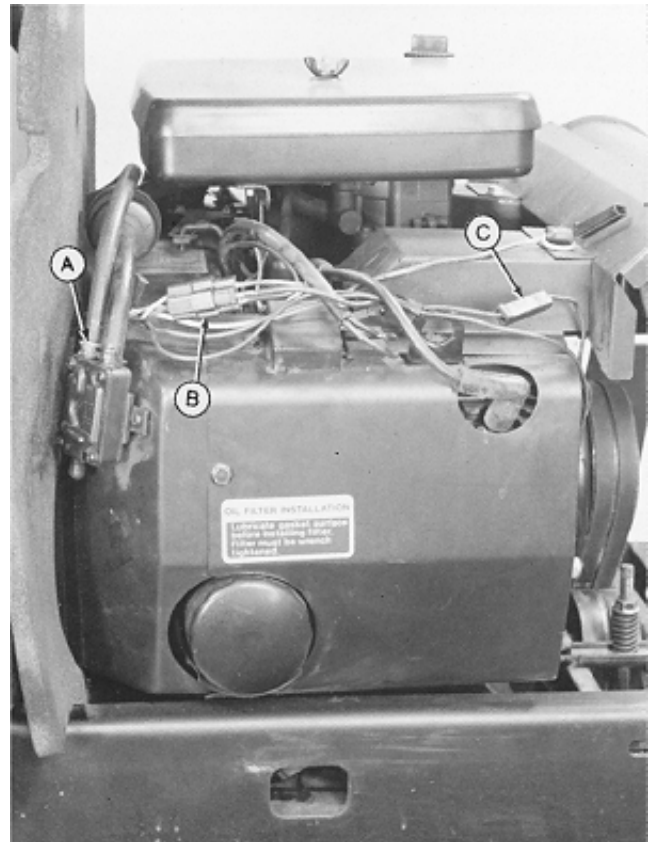

MX,15902005,2 -19-09DEC94

M49500

20-05-1

<https://www.ebooklibonline.com>

Hello dear friend!

Thank you very much for reading.

Enter the link into your browser.

The full manual is available for immediate download.

<https://www.ebooklibonline.com>