

John Deere 310A and 310B Backhoe Loaders

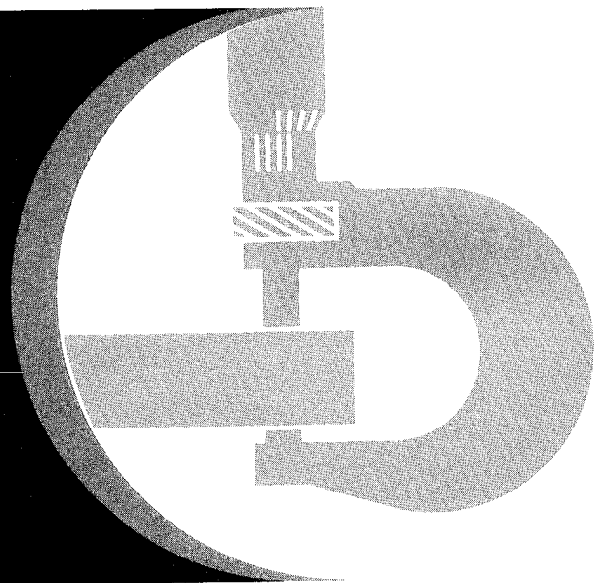

TECHNICAL MANUAL

John Deere Dubuque Works
TM-1158 (Dec-82)

Litho in U.S.A.

310A and 310B BACKHOE LOADER

TECHNICAL MANUAL
TM-1158 (NOV-86)

SECTION AND GROUP CONTENTS

SECTION I - GENERAL INFORMATION

- Group I - Introduction and Safety Information
- Group II - Cap Screw Torque Values
- Group III - General Specifications
- Group IV - Predelivery, Delivery and After-Sale Services
- Group V - Lubrication

SECTION 1 - WHEELS AND TIRES

- Group 0110 - Powered Wheels, Tires and Fastenings
- Group 0120 - Non-Powered Wheels, Tires and Fastenings
- Group 0199 - Specifications and Special Tools

SECTION 2 - AXLES AND SUSPENSION SYSTEM

- Group 0201 - Drive Axle Housing and Support
- Group 0210 - Differential
- Group 0230 - Non-Powered Wheel Axles
- Group 0299 - Specifications and Special Tools

SECTION 3 - TRANSMISSION

- Group 0315 - Controls
- Group 0341 - Housing and Covers
- Group 0351 - Gears, Shafts and Bearings
- Group 0360 - Transmission Hydraulics
- Group 0399 - Specifications and Special Tools

SECTION 4 - ENGINE

- Group 0400 - Engine Removal and Installation
- Group 0401 - Crankshaft and Main Bearings
- Group 0402 - Camshaft and Valve Actuating Means
- Group 0403 - Connecting Rods and Pistons
- Group 0404 - Cylinder Block
- Group 0407 - Oiling System
- Group 0408 - Ventilating System
- Group 0409 - Cylinder Head and Valves
- Group 0410 - Exhaust Manifold
- Group 0413 - Fuel Injection System
- Group 0414 - Intake Manifold
- Group 0415 - Engine Balancer
- Group 0417 - Water Pump
- Group 0418 - Thermostat, Housing and Piping
- Group 0419 - Oil Cooler
- Group 0420 - Fuel Filter
- Group 0421 - Fuel Transfer Pump
- Group 0422 - Starting Motor and Fastenings
- Group 0433 - Flywheel, Housing and Fasteners
- Group 0499 - Specifications and Special Tools

SECTION 5 - ENGINE AUXILIARY SYSTEMS

- Group 0505 - Cold Weather Starting Aids
- Group 0510 - Cooling Systems
- Group 0515 - Speed Controls
- Group 0520 - Intake System
- Group 0530 - External Exhaust System
- Group 0560 - External Fuel Supply System
- Group 0599 - Specifications and Special Tools

All information, illustrations and specifications contained in this technical manual are based on the latest information available at the time of publication. The right is reserved to make changes at any time without notice. Wherever applicable, specifications and design information are in accordance with SAE and ICED standards

SECTION AND GROUP CONTENTS - Continued**SECTION 7 - CLUTCH**

- Group 0715 - Controls
- Group 0741 - Housing and Covers
- Group 0752 - Elements
- Group 0799 - Specifications and Special Tools

SECTION 9 - STEERING SYSTEM

- Group 0960 - Hydraulic System
- Group 0999 - Specifications and Special Tools

SECTION 10 - SERVICE BRAKES

- Group 1011 - Active Elements
- Group 1060 - Hydraulic System
- Group 1099 - Specifications and Special Tools

SECTION 11 - PARKING - EMERGENCY BRAKES

- Group 1111 - Active Elements
- Group 1115 - Controls Linkage
- Group 1199 - Specifications and Special Tools

SECTION 16 - ELECTRICAL SYSTEMS

- Group 1671 - Batteries, Supports and Cables
- Group 1672 - Alternator, Regulator and Charging System Wiring
- Group 1673 - Vehicle Lighting System
- Group 1674 - Wiring Harness and Switches
- Group 1676 - Instruments and Indicators
- Group 1699 - Specifications and Special Tools

SECTION 17 - FRAME, CHASSIS OR SUPPORTING STRUCTURE

- Group 1740 - Frame Installation
- Group 1749 - Chassis Weights
- Group 1799 - Specifications and Special Tools

SECTION 18 - OPERATOR'S STATION

- Group 1807 - Special Noise Control Items
- Group 1810 - Operator Enclosure
- Group 1821 - Seat
- Group 1830 - Heating and Air Conditioning

SECTION 19 - SHEET METAL AND STYLING

- Group 1910 - Hood or Engine Enclosure
- Group 1921 - Grille and Grille Housing
- Group 1927 - Fenders

SECTION 20 - SAFETY, CONVENIENCE AND MISCELLANEOUS

- Group 2004 - Horn
- Group 2006 - Cigar Lighter

SECTION 21 - MAIN HYDRAULIC SYSTEM

- Group 2160 - Hydraulic System
- Group 2199 - Specifications and Special Tools

SECTION 31 - LOADER

- Group 3102 - Buckets
- Group 3115 - Controls Linkage
- Group 3140 - Loader Frames
- Group 3160 - Loader Hydraulics
- Group 3199 - Specifications and Special Tools

SECTION 33 - 9405 BACKHOE

- Group 3302 - Buckets
- Group 3315 - Controls Linkage
- Group 3340 - Frames
- Group 3360 - Hydraulic System
- Group 3399 - Specifications and Special Tools

SECTION 33A - 9500 BACKHOE

- Group 3302 - Buckets
- Group 3315 - Controls Linkage
- Group 3340 - Frames
- Group 3360 - Hydraulic System
- Group 3399 - Specifications and Special Tools

SECTION 90 - SYSTEM TESTING

- Group 9005 - General Information - Seven Basic Steps of Diagnosis and Testing
- Group 9010 - Engine
- Group 9015 - Electrical System
- Group 9020 - Power Train
- Group 9025 - Hydraulic System (Flow Meter)
- Group 9025A - Hydraulic System (Analyzer)
- Group 9030 - Miscellaneous Components
- Group 9035 - Specifications and Special Tools

<https://www.ebooklibonline.com>

Hello dear friend!

Thank you very much for reading.

Enter the link into your browser.

The full manual is available for immediate download.

<https://www.ebooklibonline.com>

Group I

INTRODUCTION AND SAFETY INFORMATION

INTRODUCTION

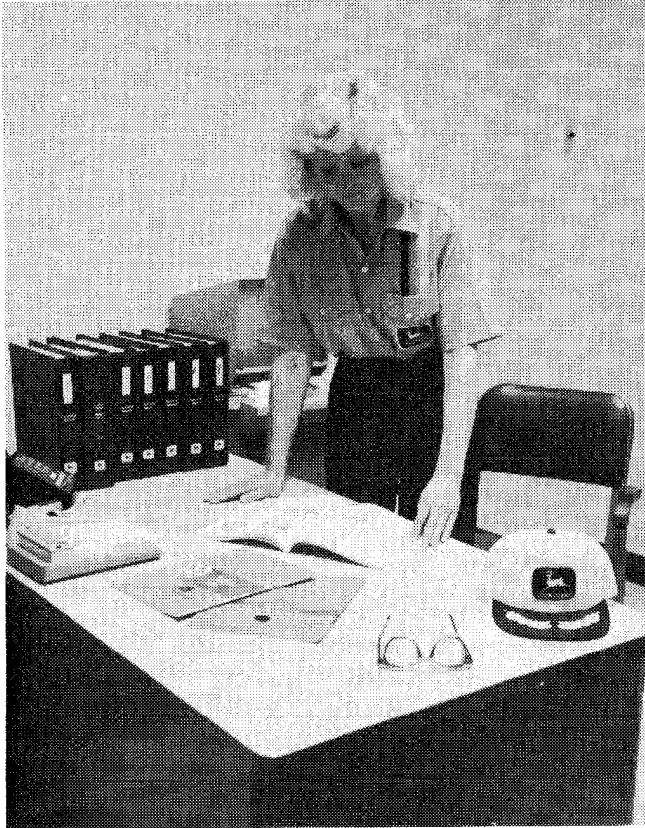

T85958

Use FOS Manuals for Reference

This technical manual is part of a twin concept of service.

FOS Manuals - for reference

Technical Manuals - for actual service

The two kinds of manuals work as a team to give you both the general background and technical details of shop service.

Fundamentals of Service (FOS) Manuals cover basic theory of operation, fundamentals of troubleshooting, general maintenance, and basic types of failures and their causes. FOS Manuals are for training new personnel and for reference by experienced technicians.

Technical Manuals are concise service guides for specific machines. Technical manuals are on-the-job guides containing only the vital information needed by an experienced service technician.

Litho in U.S.A.

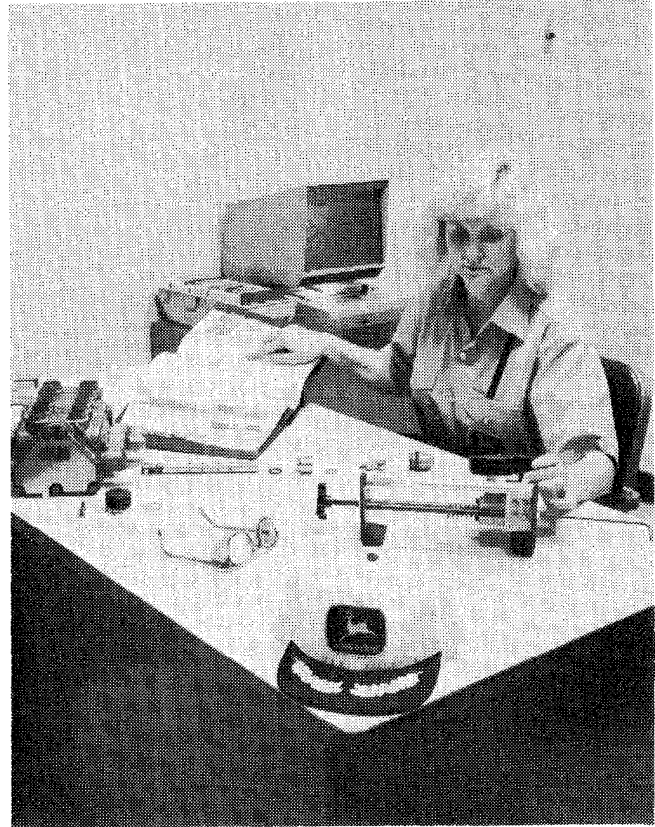

T85959

Use Technical Manuals for Actual Service

This technical manual was written for you—an experienced service technician. Keep it in a permanent binder in the shop where it is handy. Refer to it when you need to know correct service procedures or specifications.

Using technical manual as a guide will reduce error and costly delay. It will also assure you the best in finished service work.

Some features of this manual:

- Inside front cover - "Table of Contents".
- Section I - Contents, safety information, general specifications and general services.
- Sections 1 through 33 - Removal, repair, testing (components removed), installation, and adjustment.
- Section 90 - Detailed explanation of system operation, diagnosis, visual inspection, testing, and adjustments.
- Specifications and Special Tools are listed and illustrated at the end of each section.

MAINTENANCE WITHOUT ACCIDENT WORK SAFELY

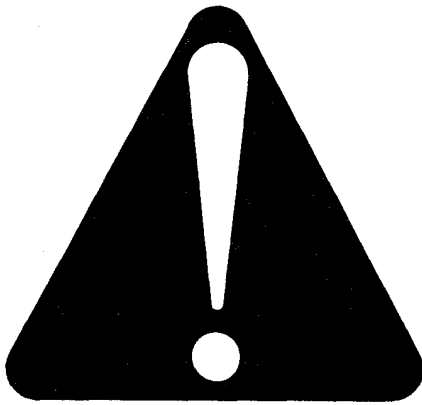

T27999N

 This safety symbol is used for important safety messages. When you see this symbol, follow the safety message to avoid personal injury.

EVERY EMPLOYER HAS A SAFETY PROGRAM. KNOW WHAT IT IS!

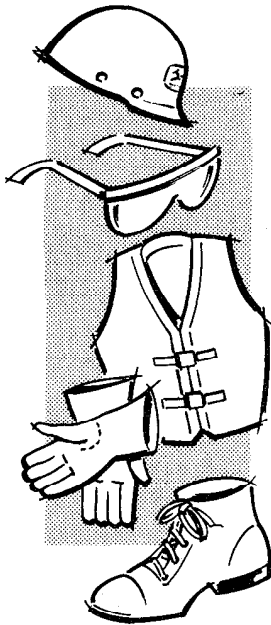

T27501N

See your shop supervisor for specific instructions on a job, and the safety equipment required.

For instance, you may need: Hard hat, safety shoes, safety goggles, heavy gloves, reflector vests, ear protectors, respirator.

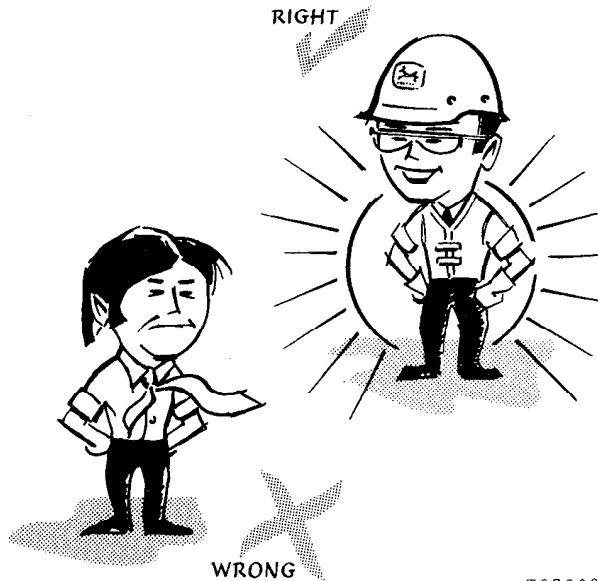

T27502N

BE ALERT!

Plan ahead — work safely — know how to use a first aid kit and a fire extinguisher — and where to get assistance.

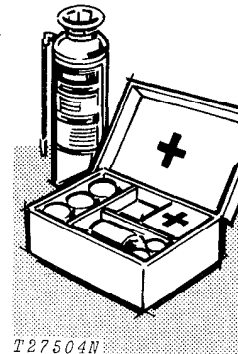

T27504N

Maintenance Area

Make sure the maintenance area has enough ventilation.

Keep the maintenance area CLEAN AND DRY. Oily and wet floors are slippery. Greasy rags are a fire hazard. Wet spots are dangerous when working with electrical equipment.

Keep starting aids in a cool, well-ventilated place, out of reach of unauthorized personnel.

MAINTENANCE WITHOUT ACCIDENT

AVOID FIRE HAZARDS

Fuel Is Dangerous!

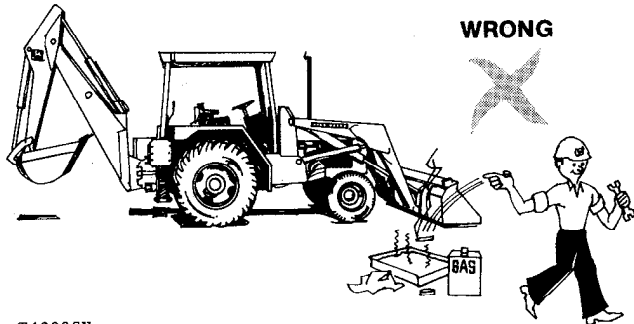

T46095N

Do not smoke while putting fuel in the fuel tank.

Do not smoke while working with material that will start on fire easily.

Stop the engine before filling the fuel tank.

Do not use gasoline or diesel fuel for cleaning parts. Use solvents that will not start on fire.

Battery Gas Is Highly Flammable!

When charging batteries, be sure there is enough ventilation.



T27506N

Do not check the battery charge by putting metal objects across the posts.

Do not let sparks or open flame near batteries.

Do not smoke near battery.

Flame Is Not a Flashlight!

NEVER USE OPEN FLAME AROUND THE MACHINE.

KNOW WHERE FIRE EXTINGUISHERS ARE KEPT!

UNDER ALL MAINTENANCE CONDITIONS

Do not work on the equipment unless you are approved to do so. Then be sure you know the safe and correct procedure.

Never work on equipment while it is being operated.

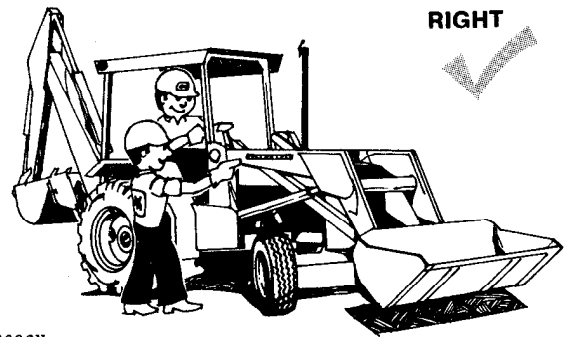

T46096N

When the engine is running, avoid working on equipment.

If you must work on the machine with the engine running, ALWAYS USE TWO service technicians. One must be at the controls. The other must be within sight of the operator.

KEEP HANDS AWAY FROM MOVING PARTS

Put a support under all raised equipment.

Never work under a raised bucket.

Lower the bucket to the ground.

If the machine is on a slope, use blocks to hold it in place.

Do not lift heavy parts by yourself. Use hoisting equipment for this.

TAKE CARE! WATCH OUT FOR OTHER PEOPLE IN THE AREA

When drilling, grinding, or hammering metal, wear safety glasses.

BE CAREFUL DURING SERVICE AND REPAIR

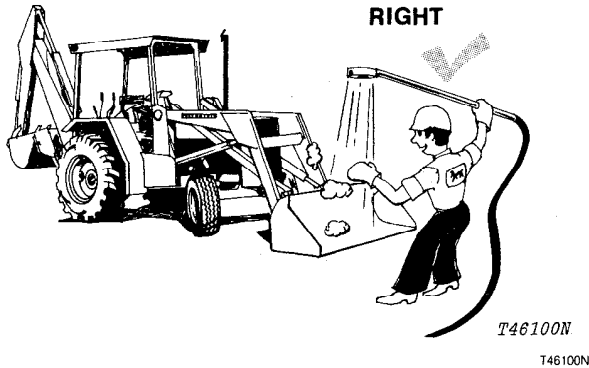

Keep ALL equipment free of dirt and oil.

Clean oil, grease, mud, ice or snow from the operator's station, steps and hand rails.

When getting the engine ready for storage, remember that inhibitor changes easily into gas and is dangerous. After adding the inhibitor, seal and tape openings. When you are not using the inhibitor, keep the can tightly closed.

Do not remove the radiator cap unless you can hold your hand on the radiator tank. First, loosen the cap slowly to the stop. Then release all pressure in the cooling system before removing the cap.

Check the exhaust system regularly for leaks.

Release hydraulic pressure before working on the hydraulic system. Stop the engine. Lower both buckets to the ground. Move the control levers until the buckets do not move.

When checking hydraulic pressure, be sure to use the correct test gauge.

Before working on the fuel system, close the fuel shut-off valve.

Before working on the electrical system, or making a major overhaul, disconnect the batteries.

KNOW EQUIPMENT IS READY!

Check all guards, shields, and safety bars. Every one must be in place and tight.

CHECK IT OUT!

- GUARDS
- SHIELDS
- SAFETY BARS
- ROLL-OVER PROTECTIVE STRUCTURES
- SEAT BELTS, ETC.

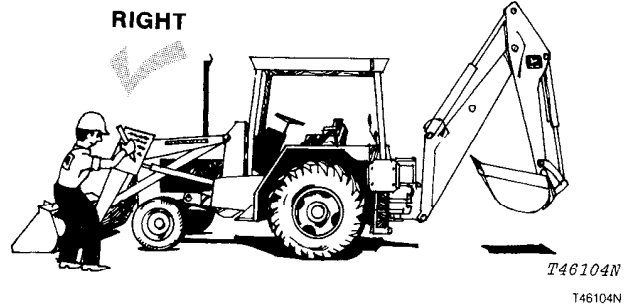

Carefully inspect all systems for leaks.

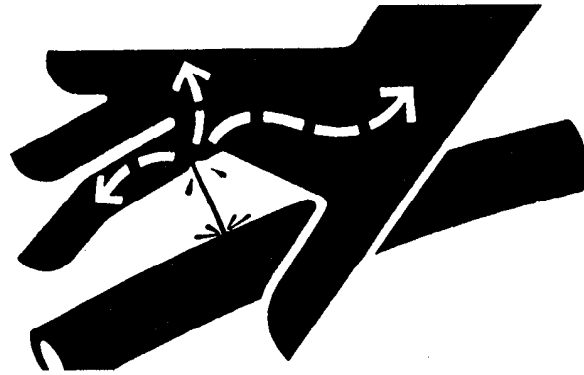

X9811

CAUTION: Escaping fluid under pressure can penetrate the skin causing serious injury. Relieve pressure before disconnecting hydraulic or other lines. Tighten all connections before applying pressure. Keep hands and body away from pinholes and nozzles which eject fluids under high pressure. Use a piece of cardboard or paper to search for leaks. Do not use your hand.

If ANY fluid is injected into the skin, it must be surgically removed within a few hours by a doctor familiar with this type injury or gangrene may result.

Group II CAP SCREW TORQUE VALUES

CUSTOMARY TORQUE SPECIFICATIONS

NOTE: Wrench torque tolerance is $\pm 10\%$.

Cap Screw in.	Plain Head*		Three Dashes*		Six Dashes*	
	(lb-ft)	N·m	(lb-ft)	N·m	(lb-ft)	N·m
1/4	-----	-----	(10)	14	(14)	19
5/16	-----	-----	(20)	27	(30)	41
3/8	-----	-----	(35)	47	(50)	68
7/16	(35)	47	(55)	75	(80)	108
1/2	(55)	75	(85)	115	(120)	163
9/16	(75)	102	(130)	176	(175)	237
5/8	(105)	142	(170)	230	(240)	325
3/4	(185)	251	(300)	407	(425)	576
7/8	(160)	217	(445)	603	(685)	929
1	(250)	339	(670)	908	(1030)	1396
1-1/8	(330)	447	(910)	1234	(1460)	1979
1-1/4	(480)	651	(1250)	1695	(2060)	2793

All torques are dry torque unless noted.

*Dashes identify the grade of hardware.

METRIC TORQUE SPECIFICATIONS

NOTE: Wrench torque tolerance is $\pm 10\%$.

Cap Screw Diameter	Property Class 8.8*		Property Class 10.9*	
	(lb-ft)	N·m	(lb-ft)	N·m
M5	(4.4)	6.0	(6.3)	8.5
M6	(7.4)	10.0	(10.7)	14.5
M8	(18.1)	24.5	(25.8)	35.0
M10	(36.1)	49.0	(51.6)	70.0
M12	(62.7)	85.0	(89.2)	121.0
M16	(154.9)	210.0	(221.2)	300.0
M20	(265.5)	360.0	(368.7)	500.0
M24	(457.2)	620.0	(634.2)	860.0
M30	(885.0)	1200.0	(1224.2)	1660.0
M36	(1541.3)	2090.0		

All torques are dry torque unless noted.

*Numbers identify the grade of hardware.

Group III

GENERAL SPECIFICATIONS

(Specifications and design subject to change without notice. Wherever applicable, specifications are in accordance with ICED and SAE standards. Except where otherwise noted, these specifications are based on a unit equipped with 16.9-24, 8-ply-rating, R4 rear tires; 11L-15, 8-ply-rating front tires; 3/4-cu. yd. (0.57 m³) loader bucket, 24-in. (610 mm) standard backhoe bucket, and standard equipment.)

Power (@ 2500 engine rpm):

	SAE	DIN
Gross	62 hp (46.2 kW)	
Net	58 hp (43.3 kW)	61.6 PS

Net engine flywheel power is for an engine equipped with fan, air cleaner, water pump, lubricating oil pump, fuel pump, alternator, and muffler. Gross engine power is without fan. Flywheel power ratings are under SAE standard conditions of 500-ft. (150 m) altitude and 85°F (29°C) temperature and DIN 70 020 standard conditions of 760 mm Hg barometer (sea level) and 20°C temperature.

Engine: John Deere 4-cylinder diesel, valve-in-head, 4-stroke cycle.

Bore and stroke	4.02x4.33 in. (102x110mm)
Piston displacement	219 cu. in. (3 588 cm ³)
Compression ratio	16.2 to 1
Maximum torque @ 1300 rpm	150 lb-ft (203 N·m) (20.7 kg-m)

NACC or AMA (U.S. Tax)
 horsepower

25.65

Main bearings

5

Lubrication

Pressure system with full-flow filter

Cooling

Pressurized with thermostat and fixed bypass

Fan

Suction

Air cleaner

Dry

Electrical system

12 volt with alternator

Batteries

Two 6 volt, 340 min. reserve capacity connected in series

Engine Clutch

Foot-operated automotive-type clutch with 10-in. (254 mm) plate.

Transmission:

Constant mesh, 8 speeds forward, 4 reverse. Standard hydraulic direction reverser permits no-clutch reversing in all gears.

*310B only

Gear:

	Travel Speeds			
	mph		km/h	
	Fwd.	Rev.	Fwd.	Rev.
1	1.4	1.6	2.3	2.6
2	2.0	2.3	3.2	3.7
3	3.0	3.5	4.8	5.6
4	4.2	4.8	6.8	7.7
5	5.5	6.3	8.9	10.1
6	7.8	9.0	12.7	14.5
7	11.7	13.5	18.8	21.7
8	16.4	18.7	26.4	30.1

Final Drives

Inboard, planetary.

Brakes

Hydraulically power actuated, fully enclosed wet-disk. Self-equalizing. Foot-operated individually or simultaneously.

Steering: Power

Turning radius (brake applied)

10 ft. 2 in.
(3.10 m)

Loader clearance (brake applied)

30 ft.
(9.14 m)

Number of turns, far left to far right

3.0

Number of turns, far right to far left

2.75

Hydraulic System: Closed-center

Pressure

2350 psi (162 bar) (165.2 kg/cm²)
 2320 psi (16 000 kPa) (163 kg/cm²)*

Loader control

Single-lever

Backhoe control

Two-lever

Pump

Piston, constant pressure,

variable-displacement, 28 gpm (1.76 L/s) @ 2500 engine rpm, 38 gpm (2.4 L/s) @ 2500 engine rpm.

Filter

25-micron steel-enclosed paper cartridge in return.

Hydraulic Cylinders:	Bore	Stroke
Loader boom	3.25 in. (83 mm)	28.7 in. (729 mm)
Loader bucket	3.25 in. (83 mm)	16.2 in. (411 mm)
Backhoe Boom	4.50 in. (114 mm)	34.0 in. (864 mm)
Backhoe crowd	4.00 in. (102 mm)	33.0 in. (838 mm)
Backhoe bucket	3.50 in. (89 mm)	27.4 in. (695 mm)
Backhoe swing	4.00 in. (102 mm)	9.3 in. (236 mm)
Stabilizer	3.50 in. (89 mm)	16.9 in. (429 mm)
Cylinder rods	Ground, heat-treated, chrome-plated, polished	
Loader backhoe swing and stabilizer cylinder rods	1.75 in. (44 mm) dia.	
Backhoe boom and bucket cylinder rods	2.25 in. (57 mm) dia.	
Backhoe crowd cylinder rod	2 in. (51 mm) dia.	

Tires:	Front	Rear
11L-15, 8 ply rating, F3	16.9-24, 8 ply rating, R4	
7.50/8.00-16, 10 ply rating, F3	19.5L-24 8 ply rating, R4	19.5L-24, 12 ply rating, R4

Wheel Treads:	
Front	58 in. (1.47 m)
Rear	65 in. (1.65 m)

Capacities:	U.S.	Imp.	Liters
Cooling system	12 qt.	10.0 qt.	11.4
Fuel tank	19.5 gal.	16.3 gal.	73.8
Engine lubrication, including filter	9 qt.	7.5 qt.	8.5
Transmission and hydraulic system	20.5 gal.	17.1 qt.	77.6
Transmission only	10 gal.	8.3 gal.	37.8

Buckets:	Nominal Heaped Capacity	Width
LOADER		
	3/4 cu. yd. (0.57 m ³)	89.4 in. (2.27 m)
	1 cu. yd. (0.76 m ³)	89.4 in. (2.27 m)
BACKHOE	Struck Capacity	Width
Standard	2.5 cu. ft. (0.071 m ³)	12 in. (305 mm)
	3.6 cu. ft. (0.102 m ³)	16 in. (406 mm)
	4.4 cu. ft. (0.125 m ³)	18 in. (457 mm)
	6.0 cu. ft. (0.170 m ³)	24 in. (610 mm)
	7.6 cu. ft. (0.215 m ³)	30 in. (762 mm)
	7.2 cu. ft. (0.204 m ³)	36 in. (914 mm)
Heavy-duty	4.4 cu. ft. (0.125 m ³)	18 in. (457 mm)
	6.0 cu. ft. (0.170 m ³)	24 in. (610 mm)
	7.6 cu. ft. (0.215 m ³)	30 in. (762 mm)
Ejector	4.2 cu. ft. (0.119 m ³)	24 in. (610 mm)

- Additional Standard Equipment:**
- ROPS with seat belt and canopy
 - Key switch with push-button safety start
 - Cushion-mount platform
 - Oil pressure indicator light
 - Alternator charge indicator light
 - Transistorized voltage regulator
 - Lights
 - Coolant temperature gauge
 - Fuel gauge
 - Electric hour meter
 - Fenders
 - Differential lock
 - Bucket level indicator
 - Horn
 - Deluxe swing-around seat
 - Foot throttle
 - Antifreeze
 - Vandal protection
 - Rear reflector
 - Horizontal muffler with vertical exhaust
 - Electrically operated destroke valve for hydraulic pump
 - Cigar lighter
 - Air cleaner restriction indicator
 - Tachometer
 - Cold weather starting aid

SAE Operating Weight with ROPS

310A	13,520 lb. (6 133 kg)
310B	13,200 lb. (5 990 kg)

- Special Equipment:**
- Front axle counterweight
 - Cab w/front and rear windshield wipers (includes ROPS)
 - Cab heater
 - Cab pressurizer
 - 24-in. (610 mm) ripper tooth for backhoe
 - Bolt-on stabilizer street pads
 - Locking instrument panel cover
 - Parking brake
 - Backup alarm
 - Reversible stabilizer pads
 - Extendable dipperstick

BACKHOE LOADER OPERATING DIMENSIONS

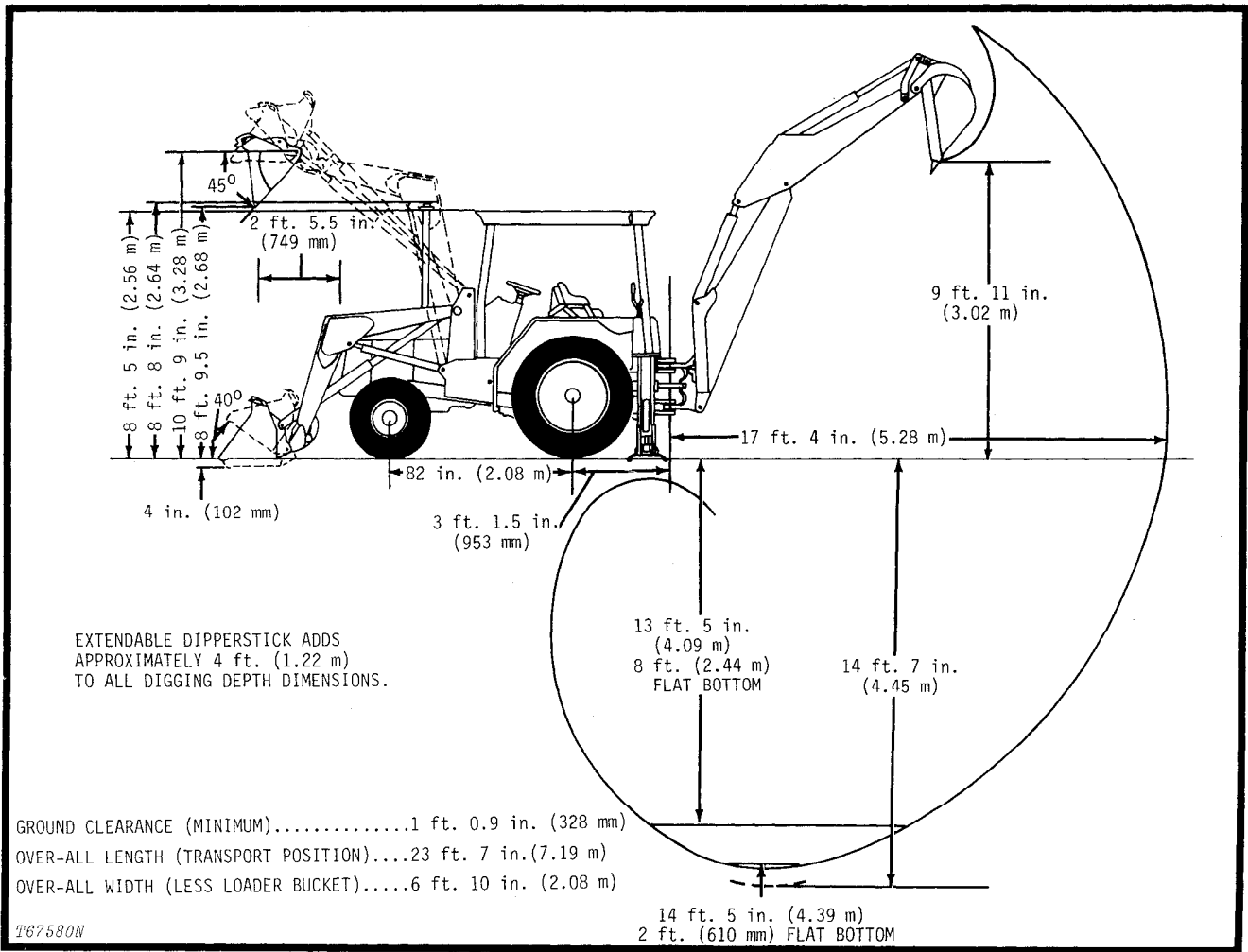

T67580N

Operating Information

Loader:

Rollback at ground level 40 deg.
Breakout force 7500 lb. (33.62 kN) (3 402 kg)
7600 lb. (34.06 kN) (3500 kg)*
Digging depth below ground level
(with bucket level) 4 in. (102 mm)
Lifting capacity, full height 5000 lb. (2 268 kg)
Height to bucket hinge pin 10 ft. 9 in. (3.28 m)
Maximum dump angle 50 deg.
Clearance, bucket dumped
at 45 degrees 8 ft. 9.5 in. (2.68 m)
Reach at maximum height, bucket
dumped at 45 degrees 2 ft. 5.5 in. (749 mm)
Raising time to full height 3.7 sec.
Bucket dump time 1.7 sec.
Lowering time (power) 2.8 sec.

Stabilizer Width:

Transport position 7 ft. 3 in. (2.21 m)
Operating position (overall) 10 ft. 2 in. (3.10 m)
Operating position (ICED) 8 ft. 9 in. (2.67 m)
* 310B only

Backhoe:

Digging depth (ICED):
Maximum 14 ft. 7 in. (4.45 m)
2-ft. (610 mm) flat bottom 14 ft. 5 in. (4.39 m)
8-ft. (2.44 m) flat bottom 13 ft. 5 in. (4.09 m)
Swing arc 180 deg.
Lifting capacity (SAE):
Boom at full reach and
full height 1500 lb. (680 kg)
Dipper lifting, boom holding,
full height 1900 lb. (860 kg)
Digging force (bucket cylinder in
power-dig position) 9600 lb. (43 kN) (4 55 kg)
Digging force, crowd
cylinder 6000 lb. (27 kN) (2 720 kg)
Reach from center of
swing mast 17 ft. 4 in. (5.28 m)
Reach from center of
rear axle 20 ft. 5.5 in. (6.24 m)
Loading height (truck-loading
position) 9 ft. 11 in. (3.02 m)
Transport height 11 ft. 3 in. (3.43 m)
Bucket rotation . Adjustable for 123, 126 or 154 deg.
Bucket positions Adjustable for 24 or 16 deg.
rollback and 2 deg. forward.

Group IV PREDELIVERY, DELIVERY, AND AFTER-SALE SERVICES

TEMPORARY STORAGE

After receiving your unit from the factory and before putting the backhoe loader into temporary storage, perform the following checks and services.

For long-term storage information, read your 310A or 310B operator's manual.

1. Check battery electrolyte level. Charge the battery if necessary.
2. Check coolant level in the radiator. The coolant should be halfway between the radiator core and filler neck.
3. Check engine oil level. Oil must be between marks on dipstick after machine has been shut down for 10 minutes.
4. Release hydraulic pressure by stopping engine, lowering boom, and operating control levers until boom and bucket do not move.

PREDELIVERY SERVICE

The service technician must carefully check and service the machine before the dealer delivers it to the customer. When the customer receives a machine that is correctly prepared, the customer is well-satisfied. For these reasons, correct predelivery service is very important to the dealer and the customer.

Use the following list when getting a unit ready for delivery to the customer.

1. Air Cleaner

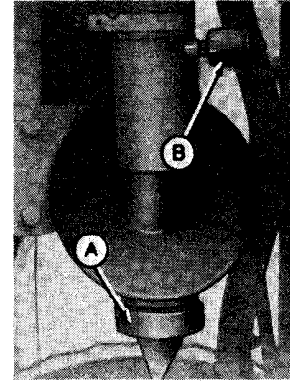

A—Dust Unloader Valve

T85044
B—Restriction Indicator

Fig. 1-Air Cleaner

Check the restriction indicator (B). If the red signal can be fully seen, check the air intake system for a restriction.

Air cleaner checked

Yes No

2. Radiator

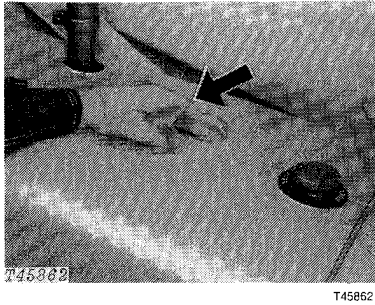

Fig. 2-Radiator Filler Cap

CAUTION: Do not remove the radiator filler cap unless the engine is cool. Then loosen the cap slowly to the stop. Release all pressure before you remove the cap.

Check the level of the coolant in the radiator. Coolant must be halfway between the radiator core and filler neck. Use clean, soft water for warm weather. Use a solution of 50% clean, soft water and 50% permanent antifreeze (ethylene glycol with approved rust inhibitor) for cold weather.

Check the cooling system for loose connections and leaks. Remove trash from the radiator.

Coolant level checked Yes No

3. Batteries

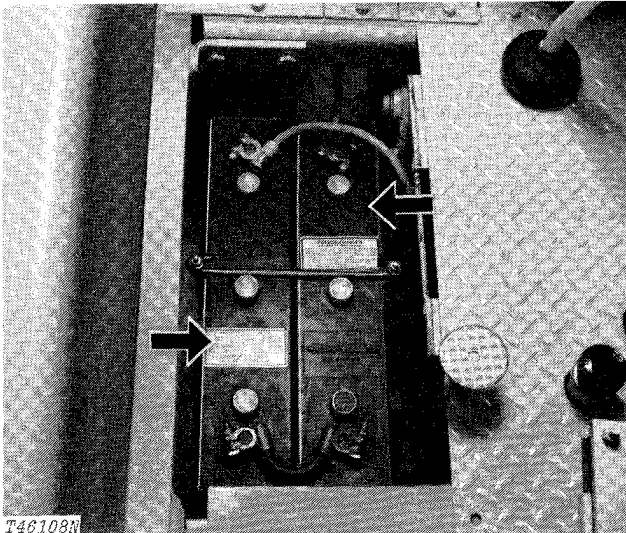

Fig. 3-Batteries

Check the electrolyte level of the batteries. Add distilled water, if necessary. Do not use hard water. Remove dirt from the top of the batteries with a damp cloth. Put petroleum jelly on terminals.

IMPORTANT: Do not add water to the batteries in freezing weather unless you run the engine 2 or 3 hours or charge the batteries.

Check battery connections.

Punch the date code on the battery.

Batteries checked Yes No

4. Tires

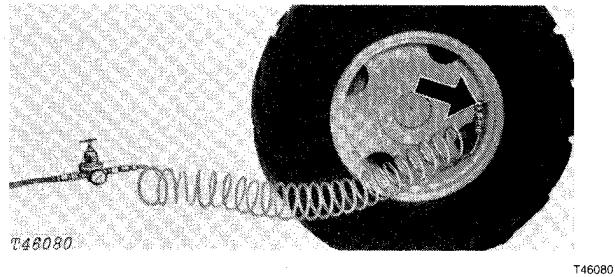

Fig. 4-Correct Tire Filling Procedure

Check air pressure in the tires with an accurate gauge having 1 psi (0.07 bar) (0.07 kg/cm²) graduations.

Front Tires

Tire Size	Type	Ply Rating	Inflation Pressure
7.50-16	F-3	10	60 psi (4.2 bar) (4.2 kg/cm ²)
11L-15	F-3	8	44 psi (3.1 bar) (3.1 kg/cm ²)

Rear Tires

Tire Size	Type	Ply Rating	Inflation Pressure
16.9-24	R-4	8	28 psi (2.0 bar) (2.0 kg/cm ²)
19.5L-24	R-4	8	34 psi (2.4 bar) (2.4 kg/cm ²)
19.5L-24	R-4	12	34 psi (2.4 bar) (2.4 kg/cm ²)

CAUTION: Failure to follow proper procedures when mounting a tire on a wheel or rim can produce an explosion which may result in serious bodily injury. DO NOT attempt to mount a tire unless you have the proper equipment and experience to perform the job safely.

Detailed tire mounting instructions, including necessary safety precautions, are contained in John Deere Fundamentals of Service (FOS) Manual 55, Tires and Tracks.

Tire pressure checked Yes No

5. Crankcase Oil Level

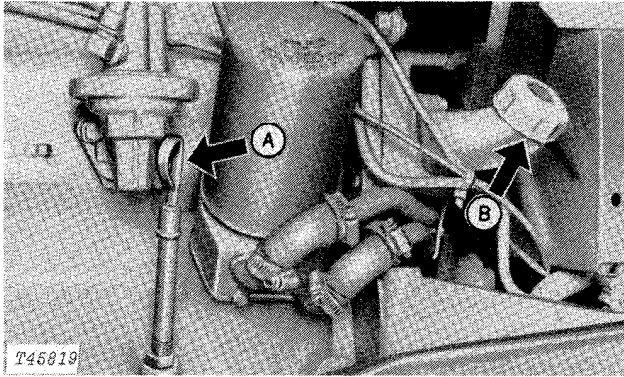

A—Dipstick B—Oil Filler Cap

Fig. 5-Crankcase Oil Level

Check the oil level when the backhoe loader is on a level surface. Wait ten minutes after stopping the engine before checking the oil level. If the oil level is at or below the bottom mark on the dipstick, add oil specified on page I-V-2. Do not operate the engine when the oil level is below the bottom mark. Keep the oil level between the marks on the dipstick.

Crankcase oil level checked Yes No
 Oil added _____qts. (L)

6. Transmission Oil Level

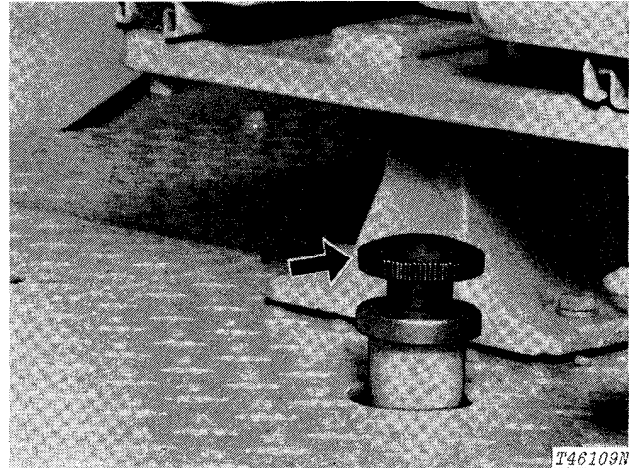

Fig. 6-Transmission Oil Level
 Dipstick and Filler Cap

Run engine two to three minutes.

Check oil level with:

- Unit on level ground.
- Engine at slow idle (800 rpm).
- Loader bucket on ground.
- Backhoe in transport position.
- Range shift lever in (P) park or parking brake engaged.
- Gear shift lever in neutral.
- Clutch engaged.

Oil level must be to top mark on dipstick. If not, add oil specified on page I-V-2.

Oil level checked Yes No
 Oil added _____qts. (L)

7. Fuel Tank

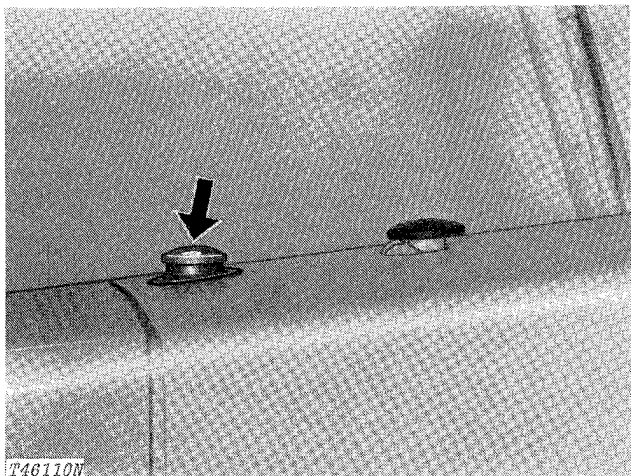
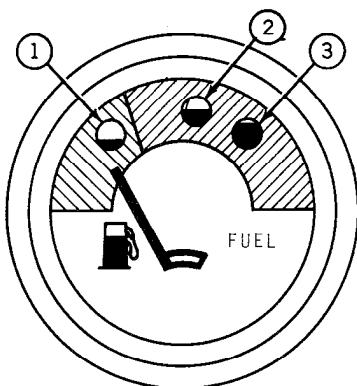

Fig. 7-Fuel Tank Filler Cap

Fill the fuel tank with correct fuel. Check the action of the fuel gauge.



T31392

1—Empty Tank
 2—Half Full Tank

3—Full Tank

Fig. 8-Fuel Gauge

Fuel tank filled	Yes	No
Fuel gauge checked	Yes	No

8. Grease Fittings

All grease fittings were checked and lubricated before the backhoe loader left the factory. However, to make sure of customer satisfaction, check each lubrication point shown on the following pages. Lubricate with several strokes of John Deere Multi-Purpose Grease or equivalent, if necessary.

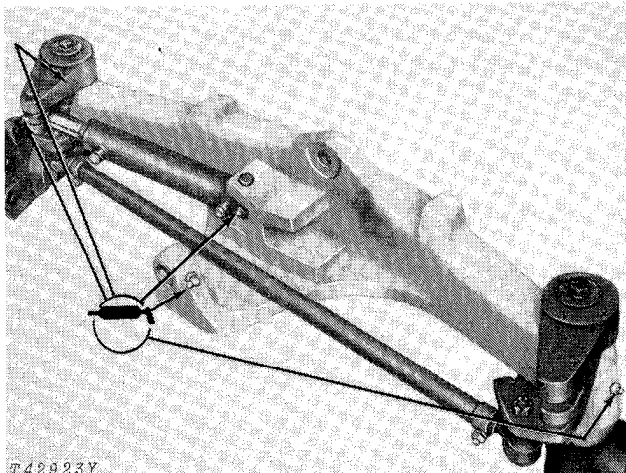

T42923Y

Fig. 9-Front Axle (5 points)

Lubrication required	Yes	No
----------------------	-----	----

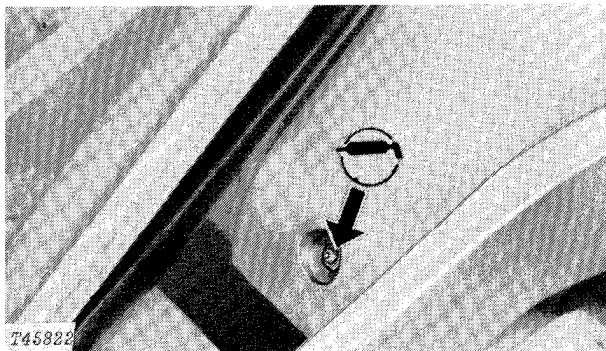

T45822

Fig. 10-Extendible Dipperstick (1 point)

Lubrication required	Yes	No
----------------------	-----	----

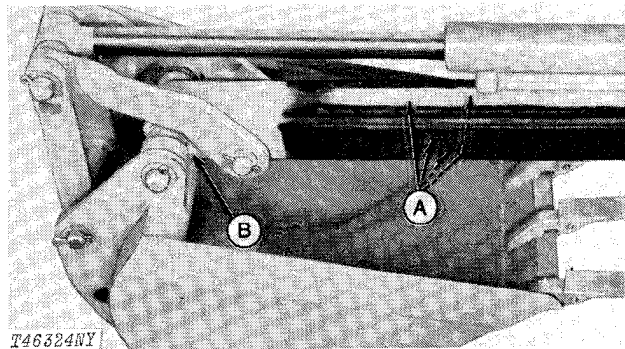

T46324NY

A—Bearing Strips

B—Drain Port

Fig. 11-Bearing Strips and Drain Port
 (Extendible Dipperstick)

Clean bearing strips. Tighten and stake screws (-368874). Lubricate strips with Digmor Special Lube (dry film).

Be sure drain port is clean.

Lubrication required	Yes	No
----------------------	-----	----

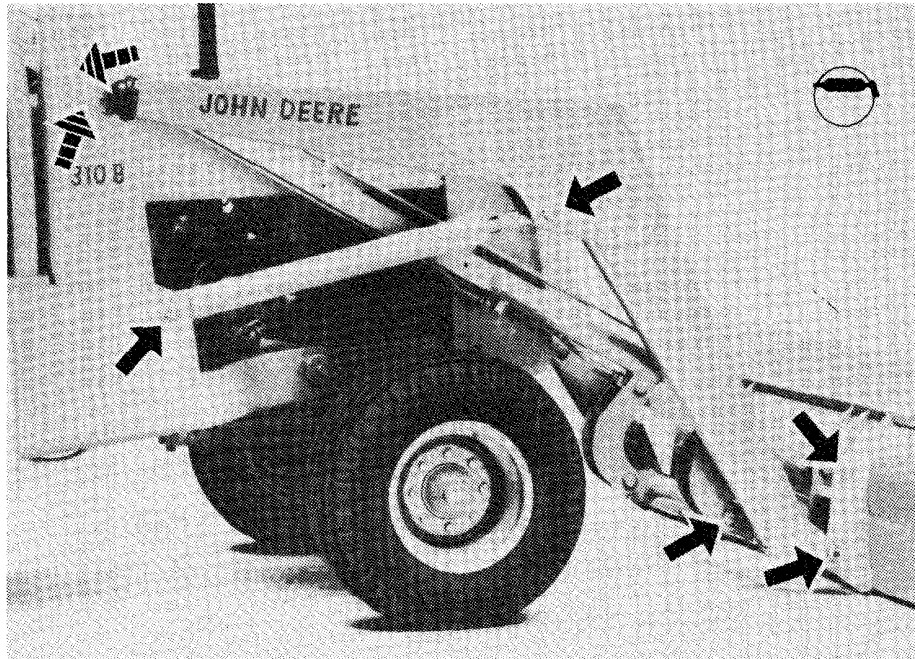

Fig. 12-Loader (14 points)

T04684

Lubrication required

Yes No

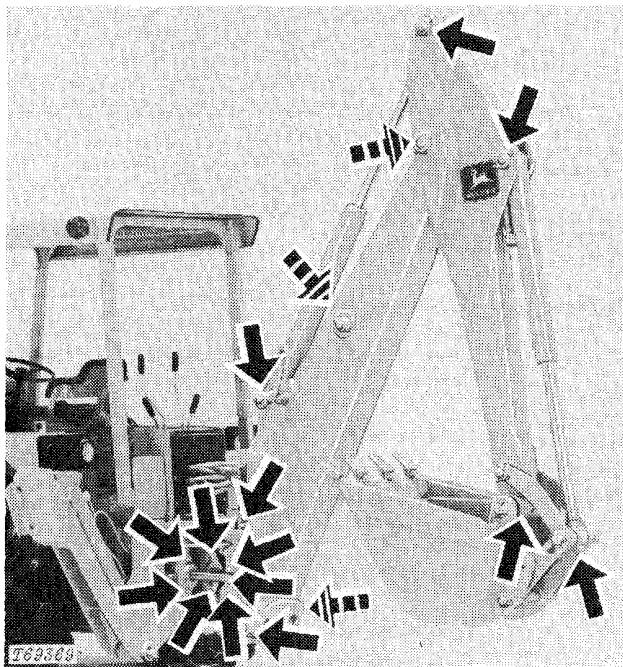
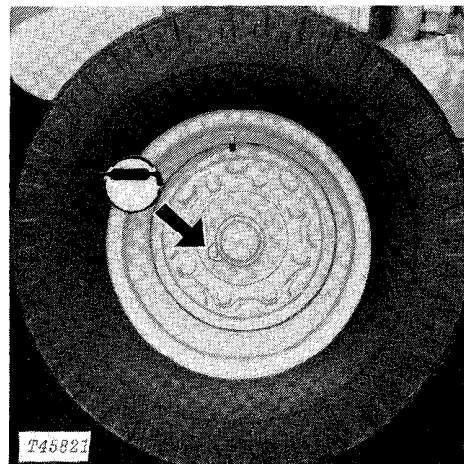

Fig. 13-Backhoe (23 points)

T69369

Lubrication required

Yes No



T45821

Fig. 14-Front Wheel Bearing (2 points)

If lubrication is needed, remove pipe plug from each front wheel. Install grease fittings.

Lubrication required

Yes No

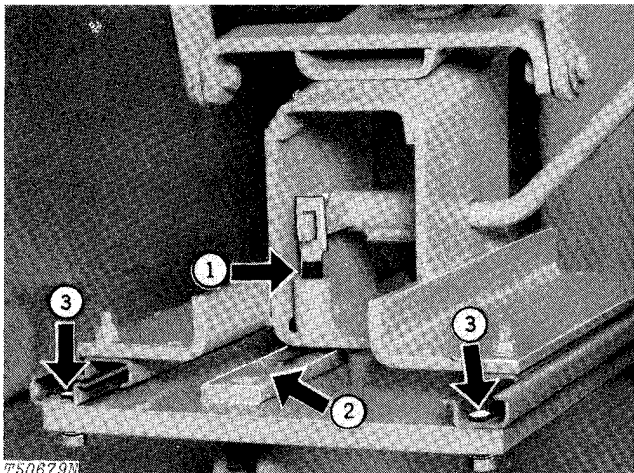

Fig. 15-Seat Lubrication

- 1 - Lubricate swivel locking pin with engine oil.
- 2 - Lubricate locking pin slide plate with John Deere Multi-Purpose Grease or equivalent.
- 3 - Lubricate bearing contact areas—both ends of adjuster. Use John Deere Multi-Purpose Grease or equivalent.

Lubrication required Yes No

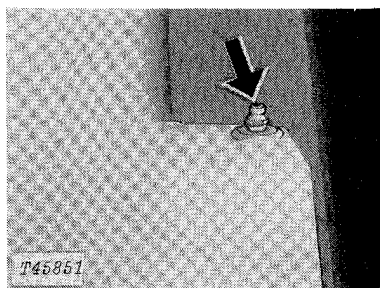

Fig. 16-Rear Axle Bearing
 (2 points)

Lubrication required Yes No

9. Air Intake Hose

Check clamps on hoses connecting air cleaner and engine. Tighten four hose clamps. Inspect hoses, for cracks.

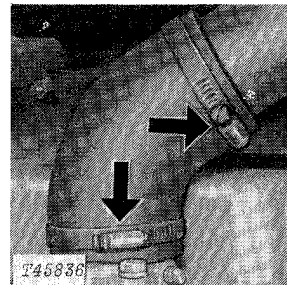
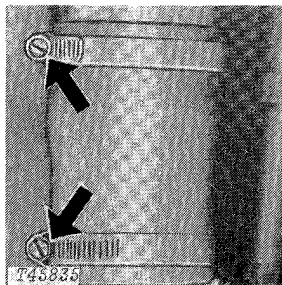

Fig. 17-Air Intake Hose Connections

Air intake hoses checked Yes No

10. Belt Tension

Check the tension of the alternator-fan belt.

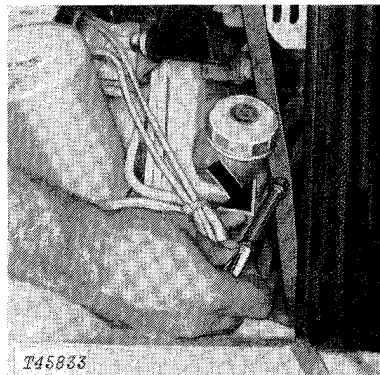

Fig. 18-Checking Tension With Tension Tester

Tension Tester

A 20 lb. (89 N) force halfway between pulleys must move the belt 3/4 in. (19 mm).

Strand Tension Gauge

Tighten a new fan belt to 135 lb. (601 N) and a used belt to 90 lb. (391 N).

Immediately after stopping the engine (run the engine 5 minutes or more), check the belt tension. If tension is less than 50 lb. (223 N), wait ten minutes. Then change tension to 90 lb. (391 N).

If adjustments are needed, see page I-IV-23.

Belt tension checked Yes No

11. Engine Speeds

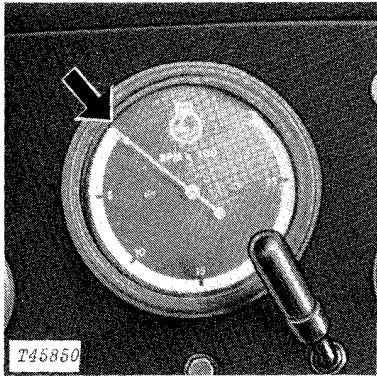
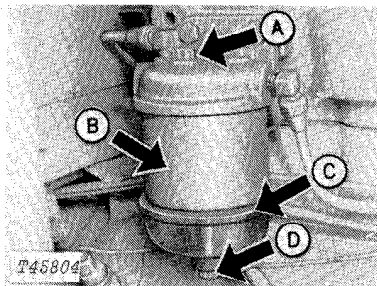

Fig. 19-Tachometer

Warm-up the engine. Use the tachometer to check speeds.

If engine speeds need adjustment, see page I-IV-23.

12. Fuel Filter



A—Bleed Plug
 B—Filter Element
 C—Sediment Bowl
 D—Drain Plug

Fig. 20-Fuel Filter (-382507)

Check fuel filter for sediment. Drain if necessary. Loosen the drain plug (D) (-382507). Drain liquid for several seconds. Tighten the plug.

Units with S.N. (382508-) are equipped with a glass enclosed fuel filter with drain plug located in lower left corner of filler housing.

NOTE: If the sediment bowl and filter are completely drained, remove air from the fuel system. See page I-IV-24.

Sediment present in filter Yes No

ENGINE RPM			
Throttle Position	Throttle	Load RPM	No Load Idle RPM
Rearward to stop	Hand	800 rpm
Forward past intermediate stop	Hand	2500 rpm	2650 rpm
Pedal down	Foot	2800 rpm

13. Indicator Lights and Gauges

Check operation of indicator lights.

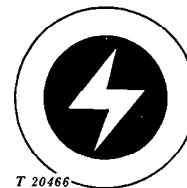

Fig. 21-Alternator Indicator Light

This light glows when alternator is not charging. If light goes on when engine is running, stop the engine. Find the cause. The light will go on when the key is in start position and engine off.

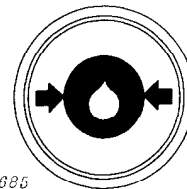

Fig. 22-Engine Oil Pressure Indicator Light

This light will go on when the crankcase oil level is low or when the oil pressure is low. When the light goes on, stop the engine. Check engine oil level. If oil level is not low, check for restrictions or wrong oil.

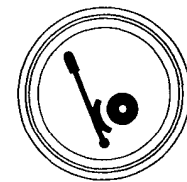
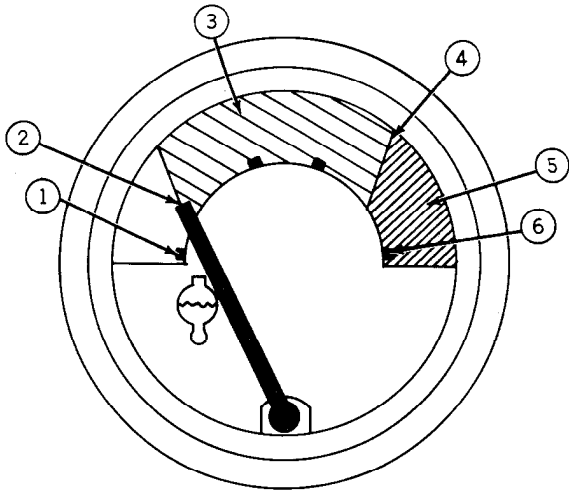

Fig. 23-Parking Brake Indicator Light

This light will go on when the parking brake is engaged and the key switch is on.

Check the operation of the gauges.



- 1—100°F (38°C)
- 2—135°F (57°C)
- 3—Light Green
- 4—224°F (107°C)
- 5—Red - Orange
- 6—240°F (116°C)

T45483N
T45483N

Fig. 24-Engine Coolant Temperature Gauge

The light green zone (3) shows the normal operating temperatures.

IMPORTANT: If the indicator hand goes into the RED-ORANGE ZONE (5), stop the engine. Find the cause.

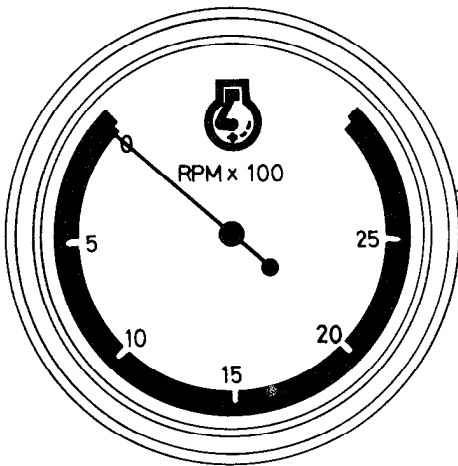

T45484N
T45484N

Fig. 25-Tachometer

The tachometer shows engine rpm.

Indicator lights and gauges checked Yes No

14. Reverser

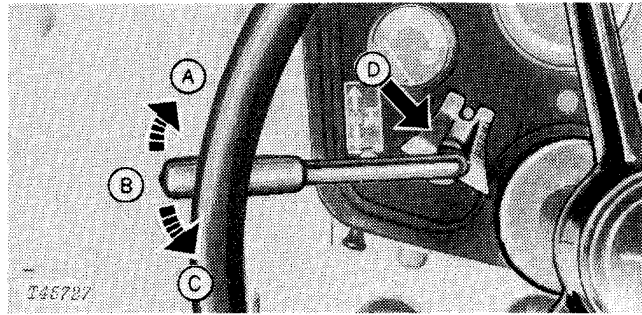

- A—Forward
- B—Neutral
- C—Reverse
- D—Neutral Lock

Fig. 26-Reverser Lever

Move the reverser lever to change the direction of travel in any gear while moving without using the clutch or shift levers.

IMPORTANT: Do not change direction at high speeds.

Do not operate the backhoe with the reverser lever in reverse position.

See page I-IV-26 for reverser speed-of-shift adjustment.

Reverser checked Yes No

15. Differential Lock

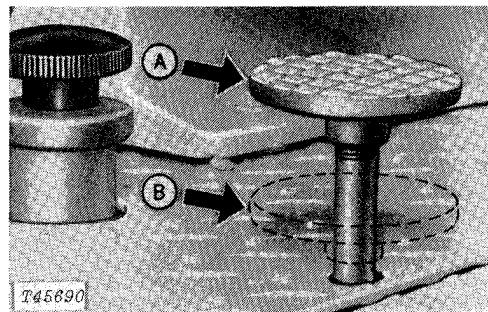

- A—Disengaged
- B—Engaged

Fig. 27-Differential Lock Pedal

Check differential lock operation.

1. Extend one stabilizer to lift one rear wheel off the ground.

2. Stop the engine. Engage the differential lock (push the pedal down).

3. Attempt to turn the raised wheel manually. If the differential lock is working correctly, the raised wheel will lock in place.

Differential lock checked Yes No

16. Transmission Shifting

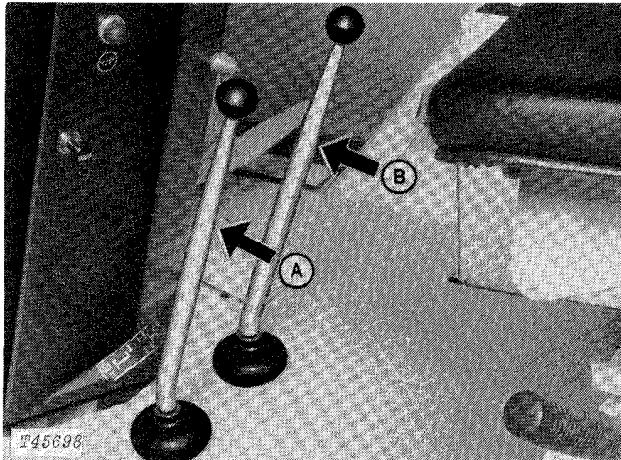

1—Range Shift Lever 2—Gear Shift Lever

Fig. 28-Transmission Shift Levers

Check operation of the transmission in all ranges and gears.

Transmission checked Yes No

17. Brakes

Check the operation of the hydraulic brakes.

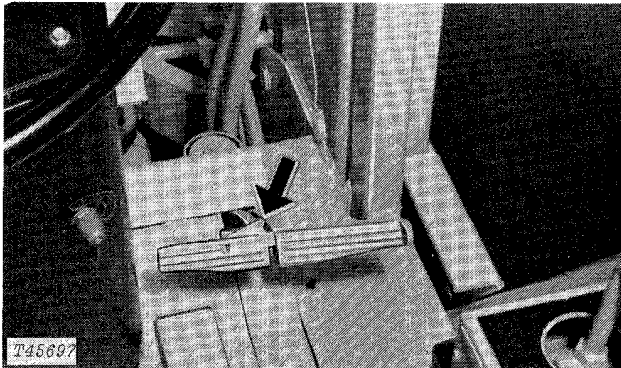

Fig. 29-Brake Pedals Connected

Put the machine in gear. Push down the brake pedal. Moderate pedal force must hold the machine in place.

Remove air from the brake system:

1. If moderate pedal force does not hold the machine in place.
2. If the pedal feels spongy.
3. If the pedal has too much travel.

See page I-IV-27 for the correct procedure.

Brakes checked Yes No

18. Clutch

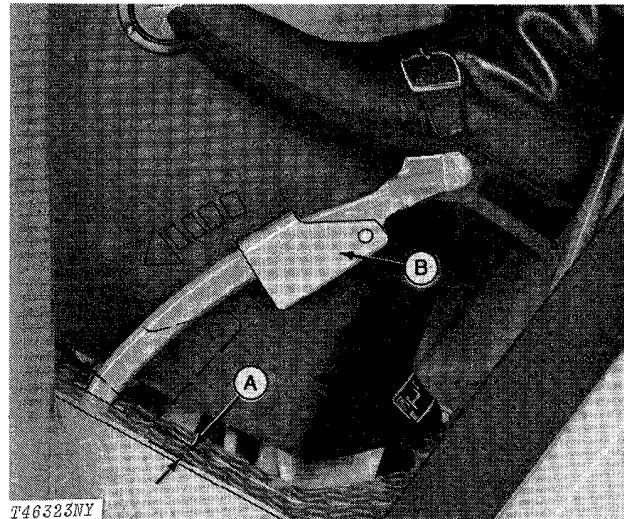

A—0.75 in. (19 mm) Maximum Clearance B—Clutch Pedal Stop

Fig. 30-Clutch Pedal Adjustment

Check the clutch pedal adjustment.

Put the clutch pedal stop down. Push down the clutch pedal until the throwout bearing contacts the clutch fingers.

Clearance between the platform and the stop must not be greater than 0.75 in. (19 mm).

If adjustment is needed, see page I-IV-28.

Clutch pedal adjustment checked Yes No

19. Seat

Check the operation of the seat.

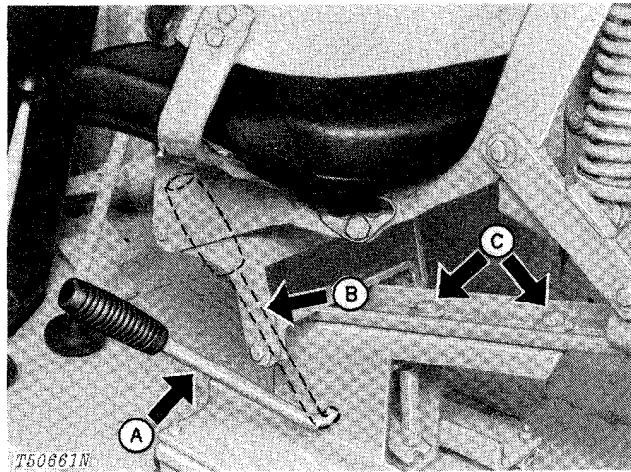

A—Seat Control Handle Locked

B—Seat Control Handle Unlocked
 C—Height Adjustment

Fig. 31-Seat Control and Adjustment

To move the seat for loader or backhoe operation:

1. Lift the seat control handle (B).
2. Slide the seat forward or to the rear.
3. Turn the seat 180°.
4. Release the handle (A). Seat must lock in place.

To change the height of the seat:

1. Loosen cap screws (C).
2. Slide the seat to the desired position.
3. Tighten the cap screws.

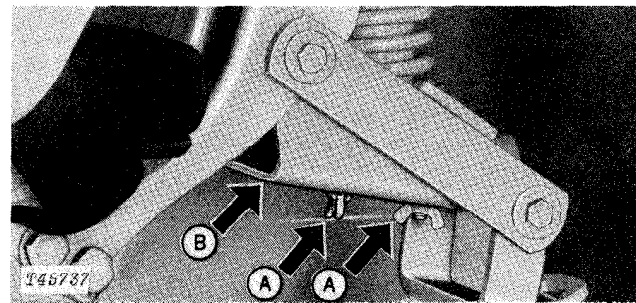

A—Wing Nuts

B—Slide

Fig. 32-Ride Adjustment

To change the ride adjustment:

1. Move seat to the upper rear position. See step 1 below.
2. Loosen wing nuts (A).
3. Move the slide to the desired position.
4. Tighten wing nuts.
5. Move seat to normal position. Seat must lock in position when you sit on it.

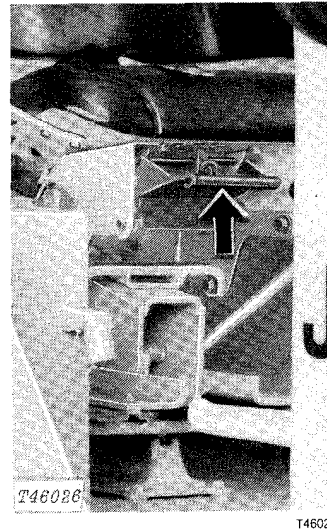

Fig. 33-Seat Release Latch

To move the seat to the upper rear position:

1. While seated, lift the latch.
2. Move the seat to the upper rear position.
3. When moving seat forward to normal position, stay in the seat.

Seat checked

Yes No

20. Accumulator

Check the accumulator action.

Run the engine five to ten minutes. Stop the engine. The steering wheel must turn easily until all hydraulic pressure is released.

If the steering wheel cannot be turned immediately after stopping the engine, the accumulator needs repair.

CAUTION: The accumulator is charged with nitrogen gas under high pressure. When servicing accumulator, see Group 2160.

Accumulator checked

Yes No

1. Power Steering

Check the operation of the power steering. Start the engine. The steering wheel must turn easily in both directions.

Number of turns:

Far left to far right 3

Far right to far left 2-3/4

Check lines and cylinders for leakage.

Power steering checked Yes No

22. Backhoe Controls

Check the operation of the backhoe controls.

CAUTION: Do not operate backhoe controls unless you are in the operator's seat facing the backhoe.

IMPORTANT: Do not operate the backhoe with the reverser lever in the reverse position.

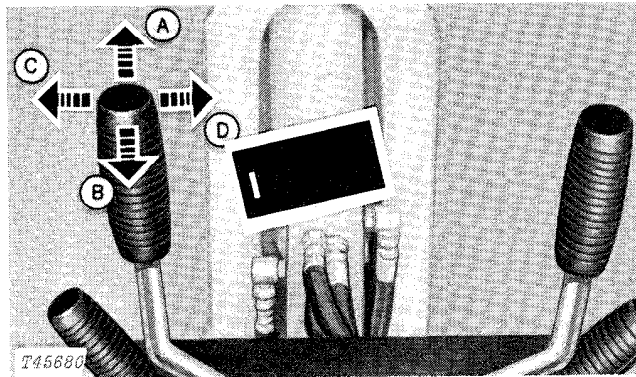

A—Lower Boom
 B—Raise Boom
 C—Boom Left
 D—Boom Right

Fig. 34-Boom Control Lever

Move the lever to one of the intermediate positions to swing the boom left or right at the same time it is being raised or lowered.

A swing brake automatically slows the boom before it hits the stops on the main frame.

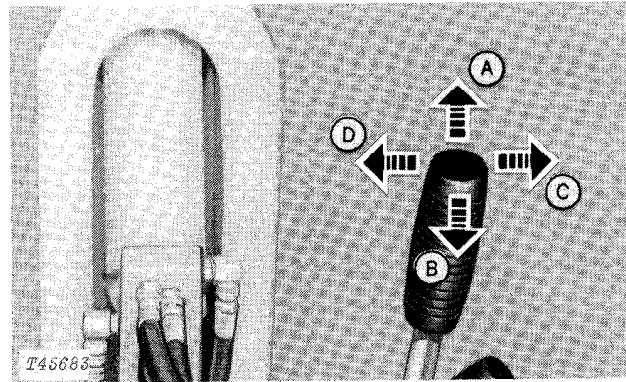

A—Dipperstick Out
 B—Dipperstick In
 C—Dump Bucket
 D—Retract Bucket

Fig. 35-Bucket and Dipperstick Control Lever

Move the lever to one of the intermediate positions to extend or retract the dipperstick at the same time the bucket is being loaded or dumped.

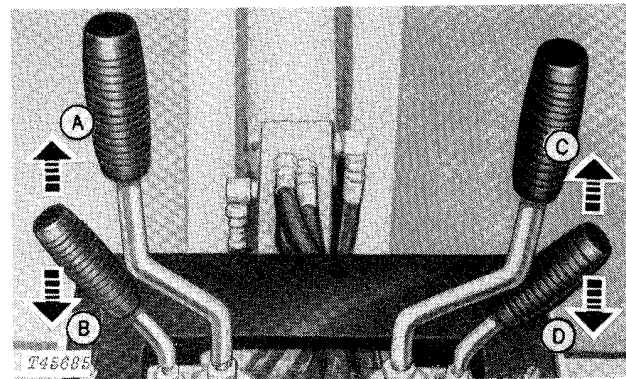

A—Left Stabilizer Down
 B—Left Stabilizer Up
 C—Right Stabilizer Down
 D—Right Stabilizer Up

Fig. 36-Stabilizer Control Levers

The stabilizers can be raised or lowered one at a time or together.

Backhoe controls checked Yes No

23. Loader Control Lever

Check the operation of the loader control lever.

CAUTION: Do not operate the loader control lever unless you are in the operator's seat facing forward.

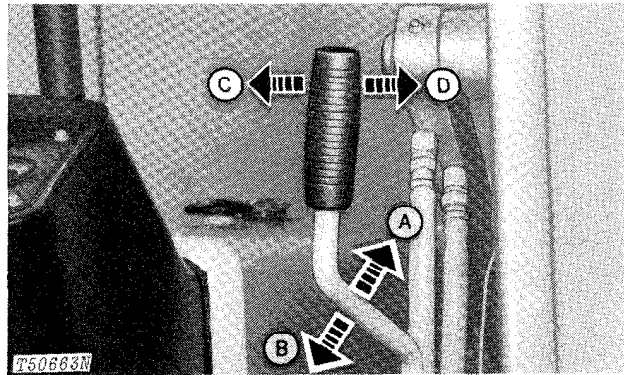

A—Lower Boom
 B—Raise Boom
 C—Retract Bucket
 D—Dump Bucket

Fig. 37-Boom and Bucket Control

For faster cycle times, move the lever to intermediate positions.

Move the lever farther to dump or retract the bucket faster.

After dumping the bucket, return the control lever immediately to neutral position.

If the lever is released during normal loader operation, it will return to neutral and the boom will be held in position.

Push the control lever all the way forward for float position. The lever will stay in this position until it is manually returned to neutral.

Loader control checked Yes No

24. Speed Controls

Check the operation of the accelerator pedal and the hand throttle.

Use the accelerator pedal to speed up the engine quickly. When the pedal is released, the engine speed will go back to the hand throttle setting.

Check hand throttle lever for freedom of movement

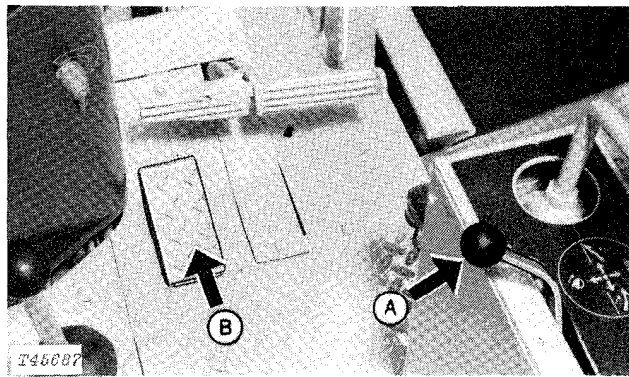

A—Hand Throttle B—Accelerator Pedal

Fig. 38-Speed Controls

Speed controls checked Yes No

25. Lights

Check the operation of the lights and light switch.

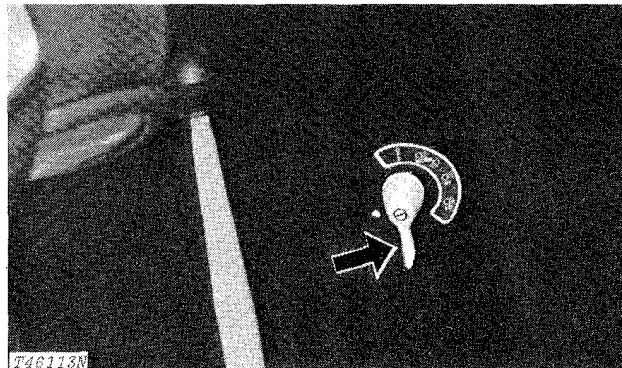
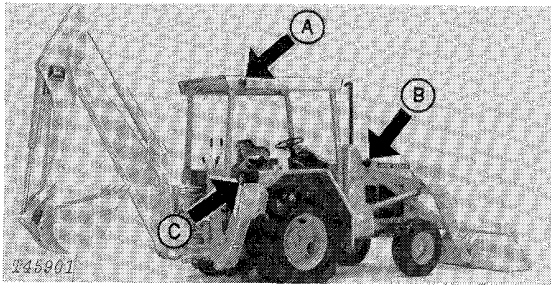

Fig. 39-Light Switch

Switch Position	Lights On
Off	All lights off
Work	B (bright) and C (white)
Hi	A, B (bright) and C (red)
Lo	A, B (dim) and C (red)



A—Warning Lamps
B—Head Lights
C—Rear Combination Lights

T45901

Fig. 40-Backhoe Loader Lights

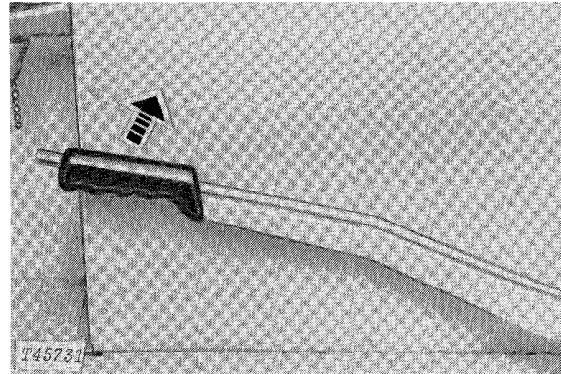
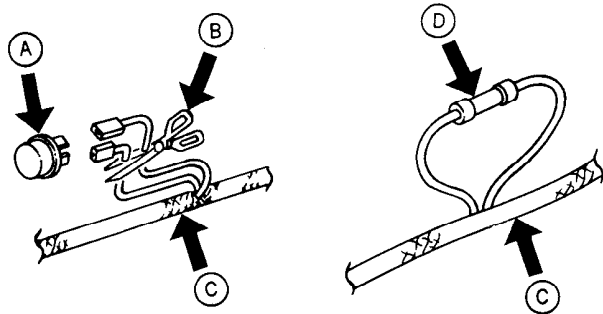

Fig. 42-Parking Brake

T45731

NOTE: The parking brake warning light will glow when the key switch is on and the parking brake is engaged. The horn will blow also if the transmission is shifted from neutral when the parking brake is engaged.

Parking brake checked Yes No



T45864

T45864

T45865

T45865

Fig. 41-Disconnecting Flashing Unit

NOTE: If flashing lights are prohibited by local regulations:

- A - Disconnect flasher unit.
- B - Cut off both female connectors on wiring lead from lamp circuit.
- C - Connect using R32028R Splice Terminal (D) (for 10-12 gauge wire) or equivalent.

Lights and light switch checked Yes No

26. Parking Brake

Check the operation of the parking brake.

1. To engage, pull up the lever until firm resistance is felt. The brake latch must be approximately in the center notch. If not, see page I-IV-33 for adjustment.

2. To disengage, lift the lever slightly and push the button. Push the lever down and release the button.

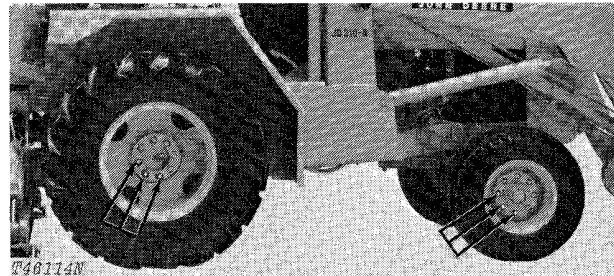

Fig. 43-Wheel Retainers

T46114N

Check wheel retainer cap screw torque.

Tighten front wheel retainers to 100 lb-ft (136 N·m) (14 kg-m).

Tighten rear wheel retainers to 425 lb-ft (576 N·m) (60 kg-m).

Wheel retainer torque checked Yes No

28. Backhoe Tapered Pins

Check the torque on the backhoe tapered pins.

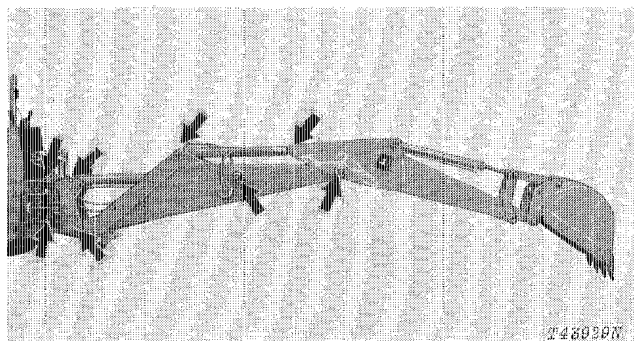

Fig. 44-Backhoe Tapered Pins

Use the torque chart on page I-II-1. If pins need to be tightened, follow the procedure on page -IV-34.

Tapered pins checked Yes No

29. Bucket Position

Be sure the backhoe bucket is in the power dig position.

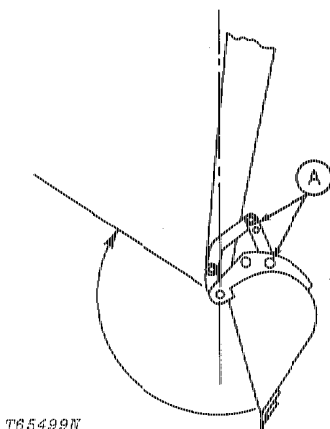

A—Install Pins

Fig. 45-Power Dig Position

30. Tow-In

Check the front wheel toe-in.

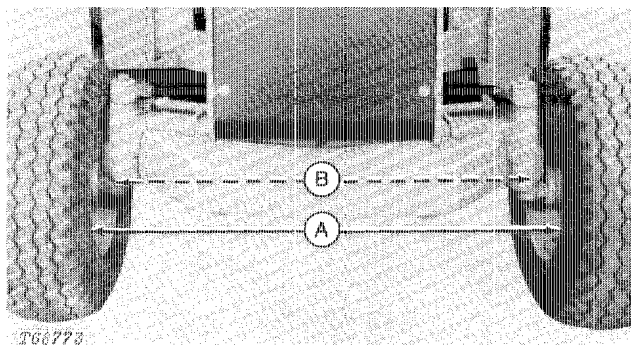

A—Distance Between Rims At Front

B—Distance Between Rims At Rear

Fig. 46-Checking Toe-In

1. Use down pressure of loader bucket to raise front wheels. Turn wheels so each valve stem is at bottom of the wheel.
2. Lower wheels to ground.
3. Measure from ground to hub.
4. Mark this distance on inside of each rim at the head of tire front and rear.
5. Measure distance between rims at front and rear marks.
6. Distance between front of rims must be 1/8 to 3/8 in. (3 to 9.5 mm) less than distance between rear of rims.

If adjustment is needed, see page I-IV-34.

Toe-in checked Yes No

31. Accessible Hardware Torque

Check all accessible bolts and nuts for the correct tightness. If hardware is loose, tighten it to the correct torque. See the torque chart on page I-II-1.

Accessible hardware checked Yes No

32. Fluid Leakage

Check the following systems for leakage due to poor or faulty connections and broken hoses or lines.

A. Cooling system checked	Yes	No
B. Hydraulic system checked	Yes	No
C. Transmission system checked	Yes	No
D. Fuel system checked	Yes	No

33. Final Check

Clean the whole unit. Make the unit LOOK like a new machine. Touch up any chipped paint. Wash the machine thoroughly. Deliver to the customer a machine anyone would be proud to own.

DELIVERY SERVICE

A thorough discussion of the operation and service of this new backhoe loader at the time of delivery helps to assure complete customer satisfaction. Proper delivery should be an important phase of a dealer's program. A portion of the John Deere Delivery Receipt emphasizes the importance of proper delivery service.

Many complaints arise because the owner was not shown how to operate and service the new backhoe loader properly. Devote enough time at the customer's convenience, to introduce the owner to the new backhoe loader. Explain how to operate and service it.

The following procedure is recommended before the service technician and owner complete the delivery acknowledgments portion of the Delivery Receipt.

Using the operator's manual as a guide, be sure the owner understands these points thoroughly:

1. The importance of safety.
2. The importance of lubrication and periodic services.
3. The importance of the break-in period.
4. Controls and instruments.
5. How to start and stop the engine.
6. All functions of the hydraulic system.

After explaining and demonstrating the above features, have the owner sign the Delivery Receipt and give the owner the operator's manual.

AFTER-SALE INSPECTION

The purchaser of a new John Deere backhoe loader is entitled to a free inspection at some mutually agreeable time within the warranty period after the equipment has been "run in," usually after 50 to 100 hours of backhoe loader operation. The terms of this after-sale inspection are outlined on the customer's John Deere Delivery Receipt.

This inspection is to make sure that the customer is receiving satisfactory performance from the backhoe loader. At the same time, the inspection should reveal whether or not the backhoe loader is being operated, lubricated, and serviced properly.

If the recommended after-sale service inspection is followed, the dealer can eliminate a needless volume of service work by preventing minor irregularities from developing into serious problems later on. This will promote strong dealer-customer relations and present the dealer an opportunity to answer questions that may have arisen during the first few days of operation.

During this inspection service, the dealer has the opportunity to promote the possible sale of other new equipment.

Check operation of all controls and instruments for freedom of movement and correct operation.



Suggest:

If the above button click is invalid.

Please download this document

first, and then click the above link

to download the complete manual.

Thank you so much for reading

<https://www.ebooklibonline.com>

Hello dear friend!

Thank you very much for reading.

Enter the link into your browser.

The full manual is available for immediate download.

<https://www.ebooklibonline.com>