

70D Excavator Repair

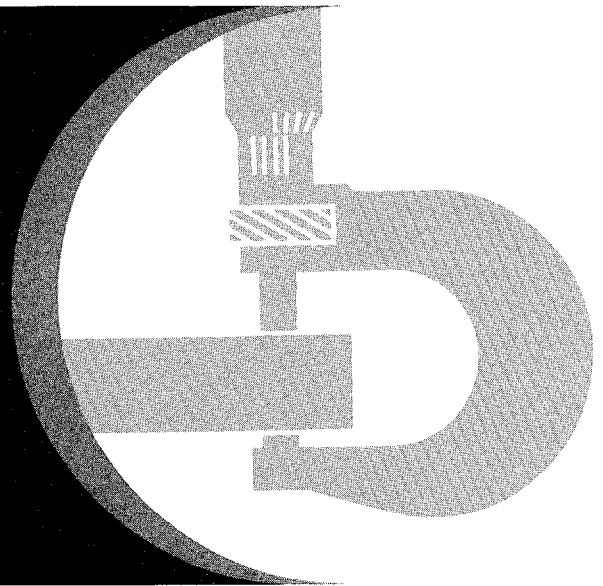

TECHNICAL MANUAL

TM1408 (14NOV89)



LITHO IN U.S.A.

Introduction

FOREWORD

This manual is written for an experienced technician. Essential tools required in performing certain service work are identified in this manual and are recommended for use.

Live with safety: Read the safety messages in the introduction of this manual and the cautions presented throughout the text of the manual.



This is the safety-alert symbol. When you see this symbol on the machine or in this manual, be alert to the potential for personal injury.

Technical manuals are divided in two parts: repair and diagnostics. Repair sections tell how to repair the components. Diagnostic sections help you identify the majority of routine failures quickly.

Information is organized in groups for the various components requiring service instruction. At the beginning of each group are summary listings of all applicable essential tools, service equipment and tools, other materials needed to do the job, service parts kits, specifications, wear tolerances, and torque values.

Binders, binder labels, and tab sets can be ordered by John Deere dealers direct from the John Deere Distribution Service Center.

This manual is part of a total product support program.

FOS MANUALS—REFERENCE

TECHNICAL MANUALS—MACHINE SERVICE

COMPONENT MANUALS—COMPONENT SERVICE

Fundamentals of Service (FOS) Manuals cover basic theory of operation, fundamentals of troubleshooting, general maintenance, and basic type of failures and their causes. FOS Manuals are for training new personnel and for reference by experienced technicians.

Technical Manuals are concise guides for specific machines. Technical manuals are on-the-job guides containing only the vital information needed for diagnosis, analysis, testing, and repair.

Component Technical Manuals are concise service guides for specific components. Component technical manuals are written as stand-alone manuals covering multiple machine applications.

Dealer Presentation Sheet

JOHN DEERE DEALERS

IMPORTANT: Please remove this page and route through your service department.

This is a complete revision for TM1408, 70D Excavator.

Listed below is a brief explanation of "WHAT" was changed and "WHY" it was changed.

This manual was revised:

1. To include additional information on disassembly and assembly of track recoil spring using ST4920 Track Recoil Spring Disassembly and Assembly Tool, and DFT1087 Track Recoil Spring Disassembly and Assembly Guard Tool.

2. To include miscellaneous changes and updates.

<https://www.ebooklibonline.com>

Hello dear friend!

Thank you very much for reading.

Enter the link into your browser.

The full manual is available for immediate download.

<https://www.ebooklibonline.com>

Contents

SECTION I—GENERAL INFORMATION

- Group I—Safety
- Group II—General Specifications
- Group III—Torque Values
- Group IV—Fuels and Lubricants
- Group V—Inspection Procedures

SECTION 01—TRACKS

- Group 0130—Track System

SECTION 02—AXLES AND SUSPENSION SYSTEM

- Group 0250—Axle Shaft, Bearings, and Reduction Gears
- Group 0260—Hydraulic System

SECTION 04—ENGINE

- Group 0400—Removal and Installation

SECTION 05—ENGINE AUXILIARY SYSTEMS

- Group 0505—Cold Weather Starting Aids
- Group 0510—Cooling System
- Group 0515—Speed Controls
- Group 0520—Intake System
- Group 0530—External Exhaust Systems
- Group 0560—External Fuel Supply Systems

SECTION 07—DAMPENER DRIVE (FLEX COUPLING)

- Group 0752—Elements

SECTION 16—ELECTRICAL SYSTEM

- Group 1671—Batteries, Support, and Cables
- Group 1672—Alternator, Regulator, and Charging System Wiring
- Group 1674—Wiring Harness and Switches
- Group 1677—Motors and Actuators

SECTION 17—FRAME or SUPPORTING STRUCTURE

- Group 1740—Frame Installation
- Group 1749—Chassis Weights

SECTION 18—OPERATOR'S STATION

- Group 1800—Removal and Installation
- Group 1810—Operator Enclosure
- Group 1821—Seat
- Group 1830—Heating and Air Conditioning

SECTION 32—BULLDOZERS

- Group 3200—Removal and Installation
- Group 3215—Controls Linkage
- Group 3260—Hydraulic System

SECTION 33—EXCAVATOR

- Group 3302—Buckets, Teeth, Shanks, and Sidecutters
- Group 3340—Frames
- Group 3360—Hydraulic System

SECTION 43—SWING OR PIVOTING SYSTEM

- Group 4311—Brakes
- Group 4350—Mechanical Drive Elements
- Group 4360—Hydraulic System

SECTION 99—DEALER FABRICATED TOOLS

- Group 9900—Dealer Fabricated Tools

All information, illustrations and specifications in this manual are based on the

Section I GENERAL INFORMATION

CONTENTS

	Page
GROUP I—Safety	
Safety	I-I-1
GROUP II—General Specifications	
70D Specifications	I-II-1
Drain and Refill Capacities	I-II-3
Working Ranges	I-II-4
Lift Capacity—kg (lb)	I-II-6
GROUP III—Torque Values	
Cap Screw Torque Values	
Metric with Letter	I-III-1
Inch	I-III-2
Metric	I-III-3
Service Recommendations	
O-Ring Boss Fittings	I-III-4
Flat Face O-Ring Seal Fittings	I-III-5
SAE Four Bolt Flange	I-III-6
GROUP IV—Fuels and Lubricants	
Fuel	
Specifications	I-IV-1
Storage	I-IV-1
Oil	
Engine	I-IV-2
Hydraulic	I-IV-3
Swing and Propel Gearbox	I-IV-4
Track Rollers and Idlers	I-IV-4
Grease	I-IV-5
Swing Bearing Grease	I-IV-5
Coolant Requirements	I-IV-6
Cold Weather Operation	I-IV-8
Alternative Lubricants	I-IV-8
Lubricant Storage	I-IV-8
GROUP V—Inspection Procedures	
Planned Inspection Program	I-V-1
Using the Checklists	I-V-1
Delivery Service	I-V-2
Checklist—PIP I	I-V-3
Checklist—PIP II	I-V-6

HANDLE FLUIDS SAFELY—AVOID FIRES

When you work around fuel, do not smoke or work near heaters or other fire hazards.

Store flammable fluids away from fire hazards. Do not incinerate or puncture pressurized containers.

Make sure machine is clean of trash, grease, and debris.

Do not store oily rags; they can ignite and burn spontaneously.



-JUN-29AUG88
TS227

O53,FLAME -19-05JAN88

PREVENT BATTERY EXPLOSIONS

Keep sparks, lighted matches, and open flame away from the top of battery. Battery gas can explode.

Never check battery charge by placing a metal object across the posts. Use a volt-meter or hydrometer.

Do not charge a frozen battery; it may explode. Warm battery to 16°C (60°F).



-JUN-29AUG88
TS204

O53,SPARKS -19-05JAN88

PREPARE FOR EMERGENCIES

Be prepared if a fire starts.

Keep a first aid kit and fire extinguisher handy.

Keep emergency numbers for doctors, ambulance service, hospital, and fire department near your telephone.

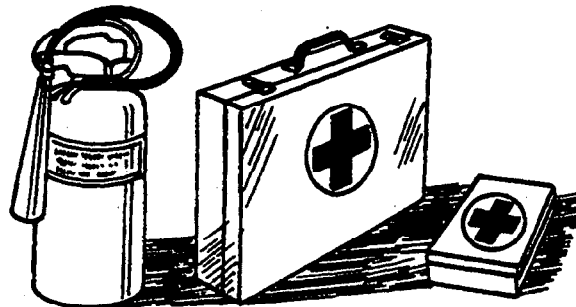

-JUN-23AUG88
TS291

O53,FIRE2 -19-03MAR88

PREVENT ACID BURNS

Sulfuric acid in battery electrolyte is poisonous. It is strong enough to burn skin, eat holes in clothing, and cause blindness if splashed into eyes.

Avoid the hazard by:

1. Filling batteries in a well-ventilated area.
2. Wearing eye protection and rubber gloves.
3. Avoiding breathing fumes when electrolyte is added.
4. Avoiding spilling or dripping electrolyte.
5. Use proper jump start procedure.

If you spill acid on yourself:

1. Flush your skin with water.
2. Apply baking soda or lime to help neutralize the acid.
3. Flush your eyes with water for 10—15 minutes. Get medical attention immediately.

If acid is swallowed:

1. Drink large amounts of water or milk.
2. Then drink milk of magnesia, beaten eggs, or vegetable oil.
3. Get medical attention immediately.

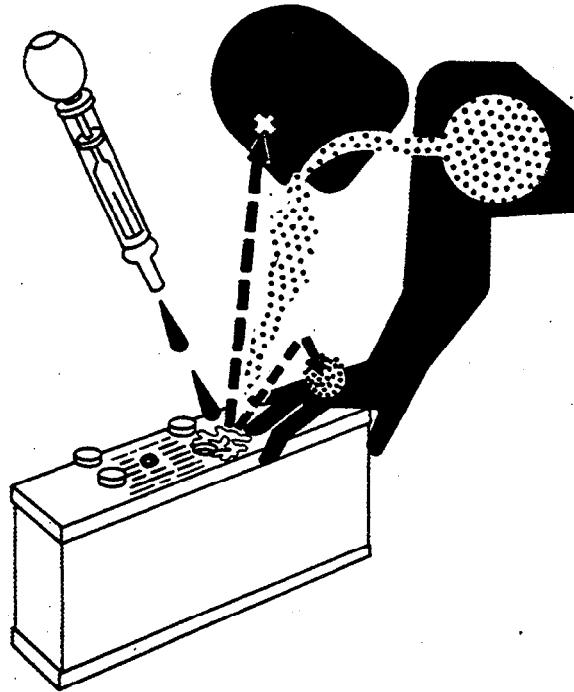

-UN-23AUG88

TS203

O53.POISON -19-21DEC87

AVOID HIGH-PRESSURE FLUIDS

Escaping fluid under pressure can penetrate the skin causing serious injury.

Avoid the hazard by relieving pressure before disconnecting hydraulic or other lines. Tighten all connections before applying pressure.

Search for leaks with a piece of cardboard. Protect hands and body from high pressure fluids.

If an accident occurs, see a doctor immediately. Any fluid injected into the skin must be surgically removed within a few hours or gangrene may result. Doctors unfamiliar with this type of injury may call the Deere & Company Medical Department in Moline, Illinois, or other knowledgeable medical source.

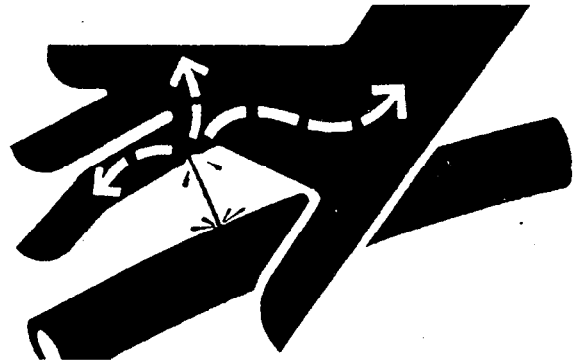

-UN-23AUG88

X9811

O53,FLUID -19-01DEC88

PARK MACHINE SAFELY

Before working on the machine:

- Lower all equipment to the ground.
- Stop the engine and remove the key.
- Disconnect the battery ground strap.
- Hang a "DO NOT OPERATE" tag in operator station.

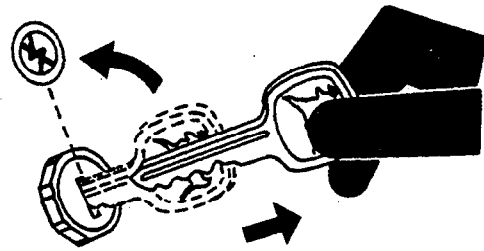

-UN-24MAY89

TS230

O53,PARK -19-05JAN88

SUPPORT MACHINE PROPERLY

Always lower the attachment or implement to the ground before you work on the machine. If you must work on a lifted machine or attachment, securely support the machine or attachment.

Do not support the machine on cinder blocks, hollow tiles, or props that may crumble under continuous load. Do not work under a machine that is supported solely by a jack. Follow recommended procedures in this manual.

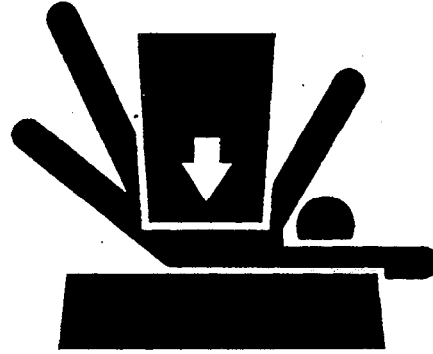

O53,LOWER -19-21DEC87

TS228 -JUN-23AUG88

WEAR PROTECTIVE CLOTHING

Wear close fitting clothing and safety equipment appropriate to the job.

Prolonged exposure to loud noise can cause impairment or loss of hearing.

Wear a suitable hearing protective device such as earmuffs or earplugs to protect against objectionable or uncomfortable loud noises.

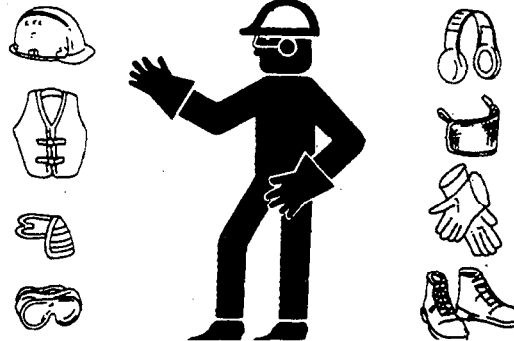

O53,WEAR -19-23APR87

TS206 -JUN-23AUG88

SERVICE MACHINES SAFELY

Tie long hair behind your head. Do not wear a necktie, scarf, loose clothing, or necklace when you work near machine tools or moving parts. If these items were to get caught, severe injury could result.

Remove rings and other jewelry to prevent electrical shorts and entanglement in moving parts.

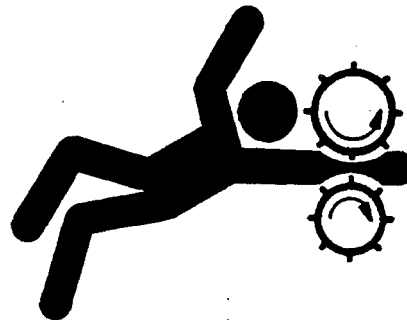

O53,LOOSE -19-21DEC87

TS228 -JUN-23AUG88

SERVICE EXCAVATOR SAFELY

Never operate the machine if an unsafe condition exists. Attach a "DO NOT OPERATE" tag to the machine.

Be sure you understand a service procedure before working on the machine.

Never lubricate or work on the machine while it is moving.

Always use two people when making checks with the engine running—the operator at the controls, able to see the person doing the checking.

Keep hands away from moving parts.

Never work under a machine raised by the boom. If the machine must be raised, keep a 90—110° angle between boom and arm.

Support the machine in the raised position by placing blocks or jackstands under machine.

Do not work under a raised bucket. Lower bucket to ground or onto blocks.

Disconnect battery ground cable (—) before welding on the machine or making adjustments on the engine or electrical system.



DO NOT OPERATE

TX.02T.05,C83 -19-18MAR87

T6283BH -19-05JAN89

WORK IN VENTILATED AREA

Engine exhaust fumes can cause sickness or death. If it is necessary to run an engine in an enclosed area, remove the exhaust fumes from the area with an exhaust pipe extension.

If you do not have an exhaust pipe extension, open the doors and get outside air into the area.

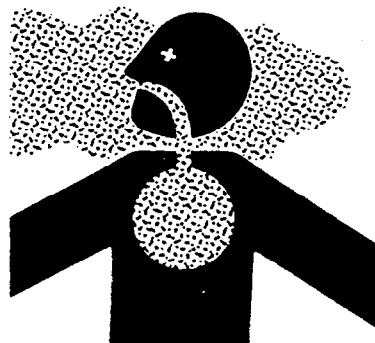

O53,AIR

-19-05JAN88

TS220 -UN-23AUG88

UNDERSTAND CORRECT SERVICE

Illuminate your work area adequately but safely. Use a portable safety light for working inside or under the machine. Make sure the bulb is enclosed by a wire cage. The hot filament of an accidentally broken bulb can ignite spilled fuel or oil.

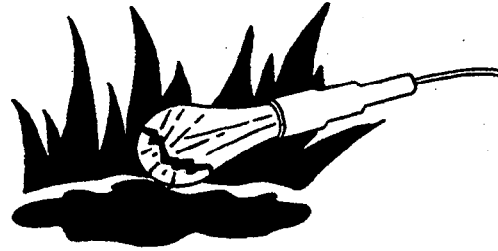

Catch draining fuel, oil, or other fluids in suitable containers. Do not use food or beverage containers that may mislead someone into drinking from them. Wipe up spills at once.

O53.LIGHT -19-23FEB88

TS223 -UN-23AUG88

REPLACE SAFETY SIGNS

Replace missing or damaged safety signs. See the machine operator's manual for correct safety sign placement.

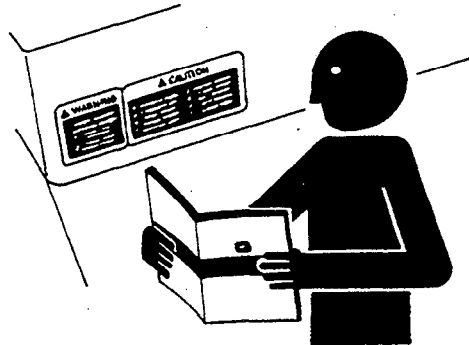

O53.SIGNS1 -19-22DEC87

TS201 -UN-23AUG88

USE PROPER LIFTING EQUIPMENT

Lifting heavy components incorrectly can cause severe injury or machine damage.

Follow recommended procedure for removal and installation of components in the manual.

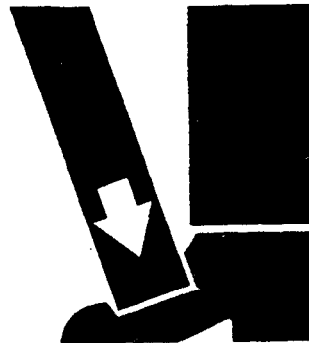

O53.LIFT -19-05JAN88

TS226 -UN-23AUG88

AVOID HARMFUL ASBESTOS DUST

Avoid breathing dust that may be generated when handling components containing asbestos fibers. Inhaled asbestos fibers may cause lung cancer.

Components in John Deere products that may contain asbestos fibers are brake pads, brake band and lining assemblies, clutch plates, and some gaskets. The asbestos used in these components is usually found in a resin or sealed in some way. Normal handling is not hazardous as long as airborne dust containing asbestos is not generated.

Avoid creating dust. Never use compressed air for cleaning. Avoid brushing or grinding of asbestos containing materials. When servicing, wear an approved respirator. A special vacuum cleaner is recommended to clean asbestos. If not available, wet the asbestos containing materials with a mist of oil or water.

Keep bystanders away from the area.

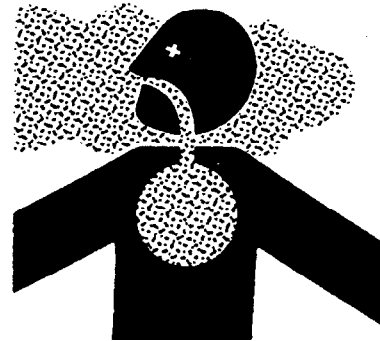

-UN-23AUG88

TS220

O53,DUST -19-14APR88

WORK IN CLEAN AREA

Before starting a job:

- Clean work area and machine.
- Make sure you have all necessary tools to do your job.
- Have the right parts on hand.
- Read all instructions thoroughly; do not attempt shortcuts.

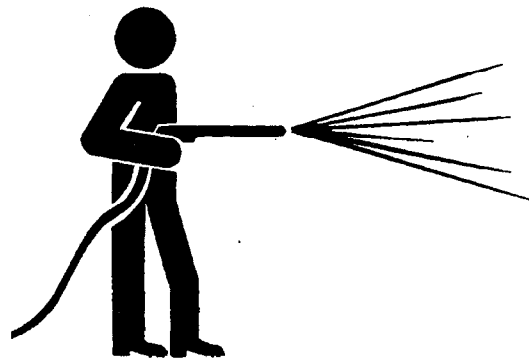

-UN-18OCT88

T6642EJ

O53,CLEAN -19-19JAN88

USE TOOLS PROPERLY

Use tools appropriate to the work. Makeshift tools, parts, and procedures will not make good repairs.

Use pneumatic and electric tools only to loosen threaded parts and fasteners. Never use such tools to tighten fasteners, especially on light alloy parts.

Use only replacement parts meeting John Deere specifications.

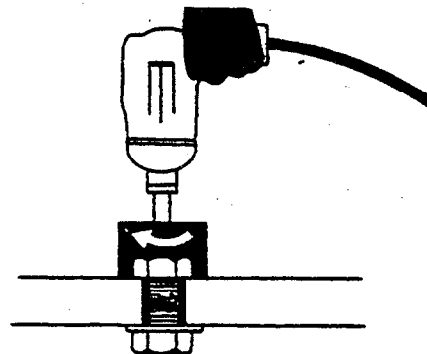

-UN-23AUG88

TS221

O53,REPAIR -19-21DEC87

DISPOSE OF FLUIDS PROPERLY

Improperly disposing of fluids can harm the environment and ecology. Before draining any fluids, find out the proper way to dispose of waste from your local environmental agency.

Avoid pouring oil into the ground, down a drain, or into a stream, pond, or lake. Observe relevant environmental protection regulations when disposing of oil, fuel, coolant, brake fluid, filters, batteries, and other harmful waste.

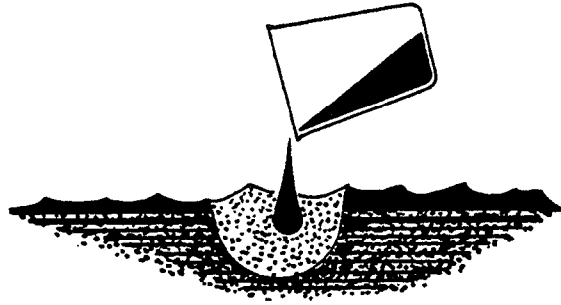

TS222 -UN-23AUG88

O53,DRAIN -19-15AUG89

LIVE WITH SAFETY

Before returning machine to customer, make sure machine is functioning properly, especially the safety systems. Install all guards and shields.



TS231 -19-07OCT88

O53,LIVE -19-05JAN88

Group II General Specifications

70D SPECIFICATIONS

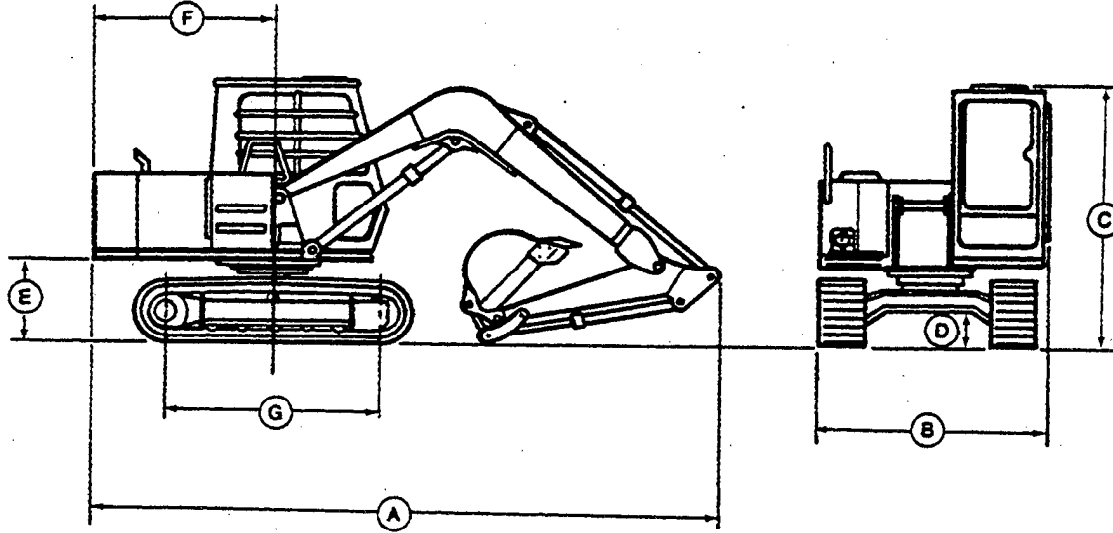

A—Overall length	
1.62 m (5 ft 4 in.) arm	6.08 m (19 ft 11 in.)
2.12 m (6 ft 11 in.) arm	6.11 m (20 ft 1 in.)
B—Overall width	
450 mm (18 in.) shoes	2.27 m (7 ft 5 in.)
600 mm (24 in.) shoes	2.35 m (7 ft 8 in.)
C—Overall height	2.6 m (8 ft 5 in.)
D—Minimum ground clearance	360 mm (1 ft 2 in.)
E—Counterweight clearance	770 mm (2 ft 6 in.)
F—Rear end swing radius	1.8 m (5 ft. 9 in.)
G—Distance between tumblers	2.1 m (6 ft 9 in.)
Standard operating weight	6 360 kg (14,020 lb)

NOTE: Specifications and design subject to change without notice. Whenever applicable, specifications are in accordance with PCSA

and SAE standards. Except where otherwise noted, these specifications are based on a unit equipped with 450 m (18 in.) shoes, 1.62 m (5 ft 4 in.) arm, 0.24 cu m (0.31 cu yd) bucket, 640 mm (25 in.) bucket, full fuel tank, 80 kg (175 lb) operator, and standard equipment.

Dozer blade (if equipped)	
Height	460 mm (18 in.)
Width	2.25 (7 ft 7 in.)
Depth of blade cut	200 mm (8 in.)
Maximum blade to ground clearance	300 mm (12 in.)

T6283BJ1 -UN-18OCT88

TX,05T,115,J35 -19-24JUN87

General Specifications/70D Specifications

Engine: John Deere 4-239D

Type	4 cycle diesel
Bore and stroke	106.5 x 110 mm (4.19 x 4.33 in.)
Number of cylinders	4
Displacement	3.9 L (239 cu in.)
Compression ratio	17.8:1
Maximum net torque @ 1200 rpm	214 N·m (21.8 kg-m) (158 lb-ft)
Lubrication	Pressure system with full-flow filter
Cooling fan	Suction
Air cleaner	Dry
Electrical system	24 volt with alternator
Batteries	Reserve capacity: 123 minutes

Power @ 2200 engine rpm	SAE
Net	41 kW (55 hp)

Hydraulic System:

Open center. Two variable-displacement axial-piston pumps and one control valves (5 and 4 spool sections) provide independent and combined operation of all functions. The 5-spool control valve section has one spool for optional offset boom or an auxiliary attachment.

Main pumps	2 variable-displacement axial-piston
Pressure setting	21 580 kPa (216 bar) (3130 psi)
Maximum oil flow	2 x 94.6 L/min (2 x 25 gpm)

Blade Pump—If Equipped	One gear type
Pressure setting	17 650 kPa (180 bar)(2560 psi)
Maximum oil flow	23.5 L/min (6.2 gpm)

Pilot pump	1 gear type
Pressure setting	3930 kPa (39 bar)(570 psi)
Maximum oil flow	23.5 L/min (6.2 gpm)

System operating pressure	21 580 kPa (216 bar)(3130 psi)
---------------------------------	--------------------------------

Relief settings

Boom raise	24 480 kPa (245 bar)(3550 psi)
Boom lower, arm and bucket	23 030 kPa (230 bar)(3340 psi)
Swing	21 580 kPa (216 bar)(3130 psi)
Travel	23 030 kPa (230 bar)(3340 psi)

Oil filtration:

- One suction filter
- One 10-micron full-flow return filter with bypass
- One 10-micron spin-on pilot filter with bypass

General Specifications/Drain and Refill Capacities

DRAIN AND REFILL CAPACITIES

	Metric	U.S.
Fuel tank	130.0 L	34.3 gal
Cooling system	12.1 L	12.7 qt
Engine oil and filter	8.5 L	9.0 qt
Hydraulic reservoir	50.0 L	13.2 gal
Swing gear	5.0 kg	11.0 lb
Swing gearbox	2.3 L	2.4 qt
Propel gearbox (each)	2.5 L	2.6 qt

TX,05T,115,J26 -19-23JUN87

General Specifications/Working Ranges

WORKING RANGES

	Standard Boom		Offset Boom	
	1.62 m (5 ft 4 in.) Arm	2.2 m (6 ft 11 in.) Arm	No Offset	Max. Offset*
A—Maximum digging reach	6.29 m (20 ft 8 in.)	6.77 m (22 ft 3 in.)	6.21 m (20 ft 5 in.)	5.75 m (18 ft 10 in.)
A ¹ —Maximum digging reach (On ground)	6.14 m (20 ft 2 in.)	6.63 m (21 ft 9 in.)	6.06 m (19 ft 11 in.)	5.60 m (18 ft 4 in.)
B—Maximum digging depth	4.10 m (13 ft 5 in.)	4.60 m (15 ft 1 in.)	4.10 m (13 ft 5 in.)	3.65 m ** (12 ft 0 in.)
B ¹ —Maximum digging depth 2.44 m (8 ft) level	3.75 m (12 ft 4 in.)	4.31 m (14 ft 2 in.)	3.7 m (12 ft 2 in.)	3.25 m (10 ft 8 in.)
C—Maximum cutting height	6.63 m (21 ft 9 in.)	6.97 m (22 ft 10 in.)	6.45 m (21 ft 2 in.)	6.14 m (20 ft 2 in.)
D—Maximum dumping height	4.62 m (15 ft 2 in.)	4.94 m (16 ft 2 in.)	4.48 m (14 ft 8 in.)	4.18 m (13 ft 9 in.)
E—Minimum swing radius	1.98 m (6 ft 6 in.)	2.18 m (7 ft 2 in.)	2.43 m (8 ft 0 in.)	2.45 m (8 ft 0 in.)
F—Maximum vertical wall	3.49 m (11 ft 5 in.)	4.05 m (13 ft 3 in.)		
Maximum cut outside of track with 450 mm (18 in.) shoes and 0.24 m ³ (0.31 yd ³) bucket				400 mm left (15.7 in.) 400 mm right (15.7 in.)

*Maximum boom offset: 1.15 m (3 ft 9 in.)

**Maximum digging depth will be less in applications where offset boom interferes with edge of trench.

TX.05T.115.J25 -19-07.JUL87



Suggest:

If the above button click is invalid.

Please download this document

first, and then click the above link

to download the complete manual.

Thank you so much for reading

General Specifications/Working Ranges

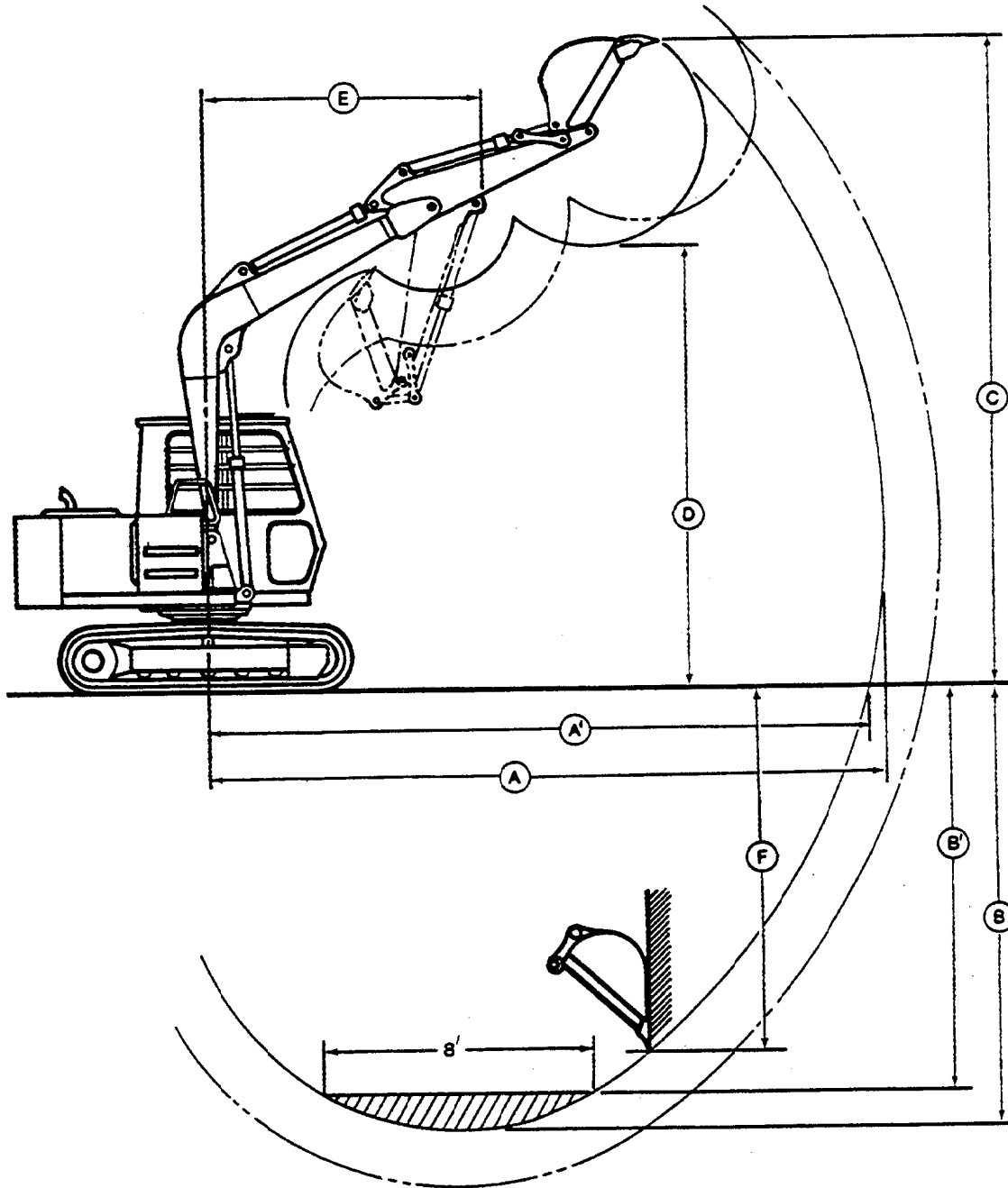

T6283BK1 -UN-18OCT88

TX,OST,115,J28 -19-07JUL87

<https://www.ebooklibonline.com>

Hello dear friend!

Thank you very much for reading.

Enter the link into your browser.

The full manual is available for immediate download.

<https://www.ebooklibonline.com>