

# 60 Series Tractor



JOHN DEERE

## SERVICE MANUAL 60 Series Tractor

SM2008 01JUN52 English

**SM2008 01JUN52**

LITHO IN U.S.A. (REVISED)  
ENGLISH



**SERVICE MANUAL FOR  
JOHN DEERE DEALERS**

**MODEL** **60** **SERIES**

**TRACTOR**

**TABLE OF CONTENTS**

	<i>Page</i>	
INDEX .....	1-2	
		<i>Section</i>
Description and Specifications .....	10	
Preparing the Tractor for Delivery to the Customer .....	20	
Tractor Tune-Up and Adjustments .....	40	
Engine .....	60	
Governor and Fanshaft Assembly .....	70	
Ignition and Electrical Systems .....	80	
Cooling System .....	90	
Engine Lubrication System .....	100	
Fuel System .....	110	
Pulley, Clutch, and Pulley Brake .....	120	
Transmission and Transmission-Driven Power Shaft .....	130	
Engine-Driven Power Shaft .....	135	
Differential and Final Drive .....	140	
Brakes .....	150	
Wheels and Tires .....	160	
Steering Mechanism and Front Axle .....	170	
Powr-Trol .....	180	

## INTRODUCTION

This Unit of the Service Manual contains maintenance instructions for the Model "60" Tractor. Included are complete instructions for removal, disassembly, inspection, repair, assembly, and installation of all parts and assemblies.

In addition, the manual contains a brief description of the more complicated systems of the tractor and tells how they operate. Dimensions of many new wearing parts are given as an aid in determining when parts replacement is necessary. Tests and adjustments required to keep the tractor operating at full efficiency are explained in detail. Full instructions on preparing a new tractor for delivery to the customer are included.

Complete instructions for testing, repairing, and adjusting the carburetor, generator, starter, distributor, and Powr-Trol Valve mechanism are given in the "Tractors and Engines (General)" Unit of the Service Manual.

If tractor design changes or improved methods of maintenance are found, new pages with the latest information will be supplied for your Service Manual. When these pages are sent to you, insert them in your manual immediately. Keep your book up-to-date at all times and you will profit by the suggestions given.

The Service Manual was planned and written for the Service Department; its place is in the shop. Use the manual whenever in doubt about correct maintenance procedures. Use it as a text book for new Service Department personnel who are unfamiliar with John Deere Tractors.

Daily use of the Service Manual as a guide for any and all service problems will reduce error and costly delay to the minimum and assure you the best in finished service work.

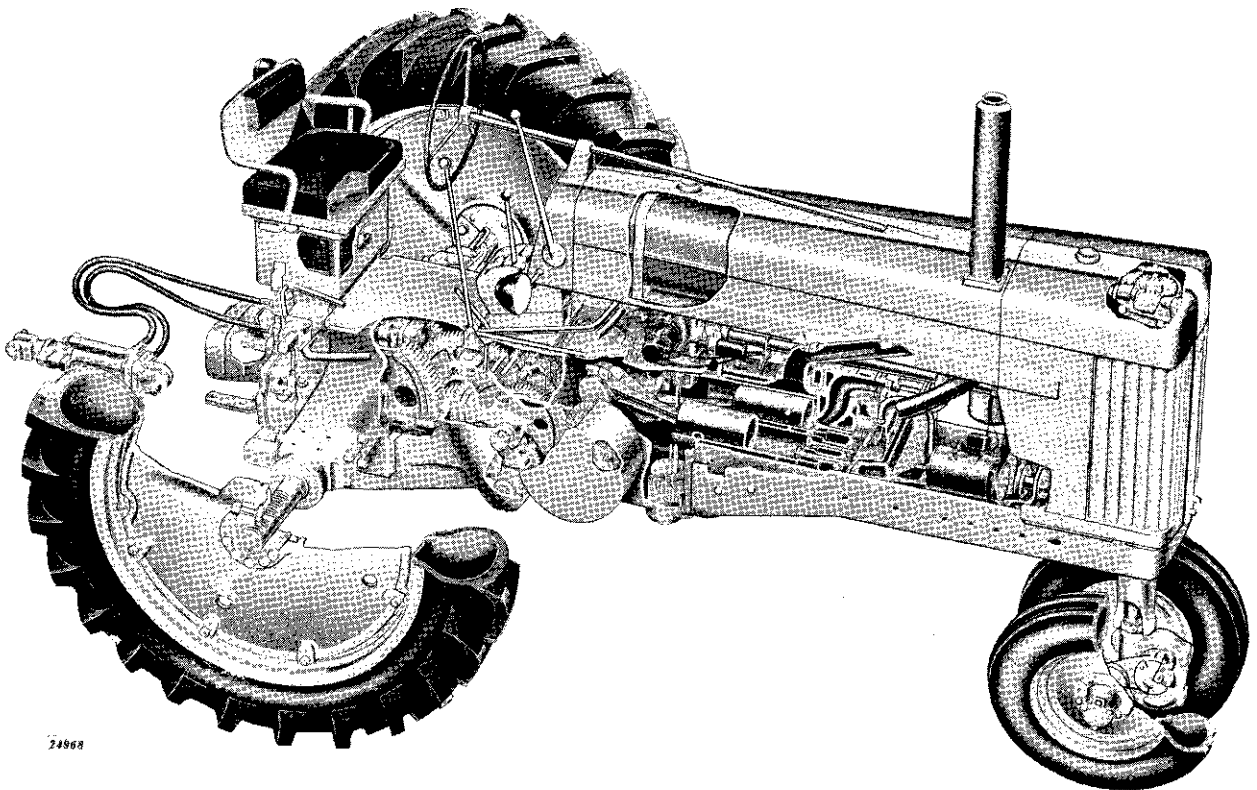

*Cut-Away View of John Deere Model "60" Tractor*

**<https://www.ebooklibonline.com>**

Hello dear friend!

Thank you very much for reading.

Enter the link into your browser.

The full manual is available for immediate download.

**<https://www.ebooklibonline.com>**



<b>L</b>	<i>Page</i>	<b>L</b>	<i>Page</i>
Lights.....	80-20-1	Rings, Piston.....	60-15-2
Linkage, Speed Control.....	40-5-8	Rockshaft Housing.....	180-10-1
Linkage, Starter Control.....	40-5-10	Roll-O-Matic.....	160-5-1, 170-10-1
Lock, Roll-O-Matic.....	170-10-1		
Lubrication System.....	100-5-1	<b>S</b>	
		Shaft, Governor.....	70-5-2
<b>M</b>		Shifters.....	130-10-2
Main Bearings.....	60-20-1	Shifter Adjustment.....	130-10-4
Main Bearing Measurements.....	60-20-5	Shifter Lever, Power Shaft.....	130-20-1
Manifold.....	60-10-1	Shifter Shafts.....	130-10-2
Master Gauge, Use of.....	40-5-8	Shutter.....	90-15-1
Motor, Starting.....	80-10-1	Single Front Wheel.....	160-5-3
		Sliding Gear Shaft.....	130-15-1
		Slow Idle Speed Adjustment.....	40-5-7
<b>O</b>		Spark Plugs.....	80-5-2
Oil Pressure Adjustment.....	40-5-8, 100-15-1	Speed Control Lever, Adjustment.....	40-5-8
Oil Filter.....	100-10-1	Speed Control Linkage.....	40-5-8
Oil Pressure Gauge.....	100-15-1	Spindle, Front Wheel, Roll-O-Matic...	170-10-3
Oil Pump, Engine.....	100-5-1	Spindle, Wheel, Adj. Front End.....	170-15-4
Oil Pump, Power Shaft.....	135-10-2	Starter Control Linkage.....	40-5-10
		Starting Motor.....	80-10-1
<b>P</b>		Steering Shaft.....	170-5-1
Pedal, Brake.....	150-5-3	Steering Shaft and Worn End Play Adj.	170-5-6
Pedestal.....	170-5-1	Steering Shaft Backlash Adj.....	170-5-6
Pistons.....	60-15-1	Steering Spindle.....	170-5-2
Piston Measurements.....	60-15-2	Steering Spindle End Play Adj.....	170-5-5
Piston Pins.....	60-15-2		
Piston Rings.....	60-15-2	<b>T</b>	
Power Shaft Clutch.....	135-10-1	Tappet Adjustment.....	60-10-6
Power Shaft Clutch Adj.....	135-10-6, 135-10-7	Tappet Clearance.....	40-5-5
Power Shaft, Engine-Driven.....	135-5-1	Thermostat.....	90-15-1
Power Shaft, Trans.-Driven...	135-5-1, 135-20-1	Throttle Control Linkage.....	110-5-2
Powr-Trol Adjustment.....	40-5-11	Timing Distributor.....	40-5-4
Powr-Trol Cracking Pressure.....	40-5-11	Timing Light.....	40-5-4
Powr-Trol Pump.....	180-5-1	Tires.....	160-15-1
Powr-Trol Relief Valve.....	40-5-12	Toe-In Adjustment.....	170-15-6
Powr-Trol Valve Housing.....	180-10-1	Tractor, Model "60," Description....	10-5-1
Preparing the Tractor for Delivery....	20-5-1	Tractor, Model "60," Specifications...	10-10-1
Pressure Regulator, Oil.....	110-10-1	Transmission.....	130-5-1
Pulley.....	120-5-1	Tread Adjustment.....	160-10-1
Pulley Brake.....	120-5-1, 120-10-1	Tune-Up.....	40-5-1
Pulley Brake Adjustment.....	120-10-3		
Pump, Oil, Engine.....	110-5-1	<b>V</b>	
Pump, Oil, Power Shaft.....	135-10-2	Valves.....	60-10-1
Pump, Powr-Trol.....	180-5-1	Valve Timing.....	40-5-5
Pump, Ventilator.....	70-5-1, 70-15-1	Valve, Fuel, Three-Way.....	110-10-1
Pump, Water.....	90-10-1	Valve Housing, Powr-Trol.....	180-10-1
		Ventilator Pump.....	70-5-1, 70-15-1
<b>R</b>			
Radiator.....	90-5-1	<b>W</b>	
Radiator, Cleaning.....	40-5-6	Water Pump.....	90-10-1
Radiator, Core.....	90-5-2	Wheels, Front.....	160-5-1
Rear Axles.....	140-10-1	Wheels, Rear.....	160-10-1
Rear Wheels.....	160-10-1	Wheel Weights.....	160-15-2
Rear Wheel Tread Adjustment.....	160-10-1	Wide Adjustable-Tread Front Axle...	170-15-1
Reduction Gear Cover.....	120-10-1	Wiring Diagram.....	80-20-1
Regulator, Current-Voltage.....	80-15-1	Worm, Steering Shaft.....	170-5-1
Relief Valve, Powr-Trol.....	40-5-12		

## Section 10

# Description and Specifications

### Group 5 DESCRIPTION

The John Deere Model "60" Tractor is a general purpose tractor with sufficient power to pull two 16-inch plow bottoms or the equivalent under normal conditions, or three 14-inch plow bottoms under favorable conditions. The tractor has six forward speeds and one reverse speed.

The features of the tractor are described briefly in the paragraphs which follow. Full descriptions of each of the components or assemblies are contained in the various Sections throughout this manual.

#### Serial Numbers.

Each tractor bears a serial number located on top of the main case just under the distributor (Figure 10-5-1).

The distributor and the Powr-Trol valve hous-

ing also bear serial numbers.

#### Engine.

The tractor is powered by a two-cylinder, cast-in-block, valve-in-head engine with a displacement of 321 cubic inches. Rotation is counterclockwise when viewed from the fly-wheel side.

The engine has aluminum alloy, sleeve-type main bearings and replaceable, precision-type connecting rod bearings. All bearings and other parts of the engine are pressure lubricated by a full force feed pressure system with a full flow oil filter. The system includes a replaceable Purolator filter element. The crankcase is ventilated by a pump located on the rear end of the fan shaft. Engine speeds are controlled by a fly-ball type governor driven by the camshaft.

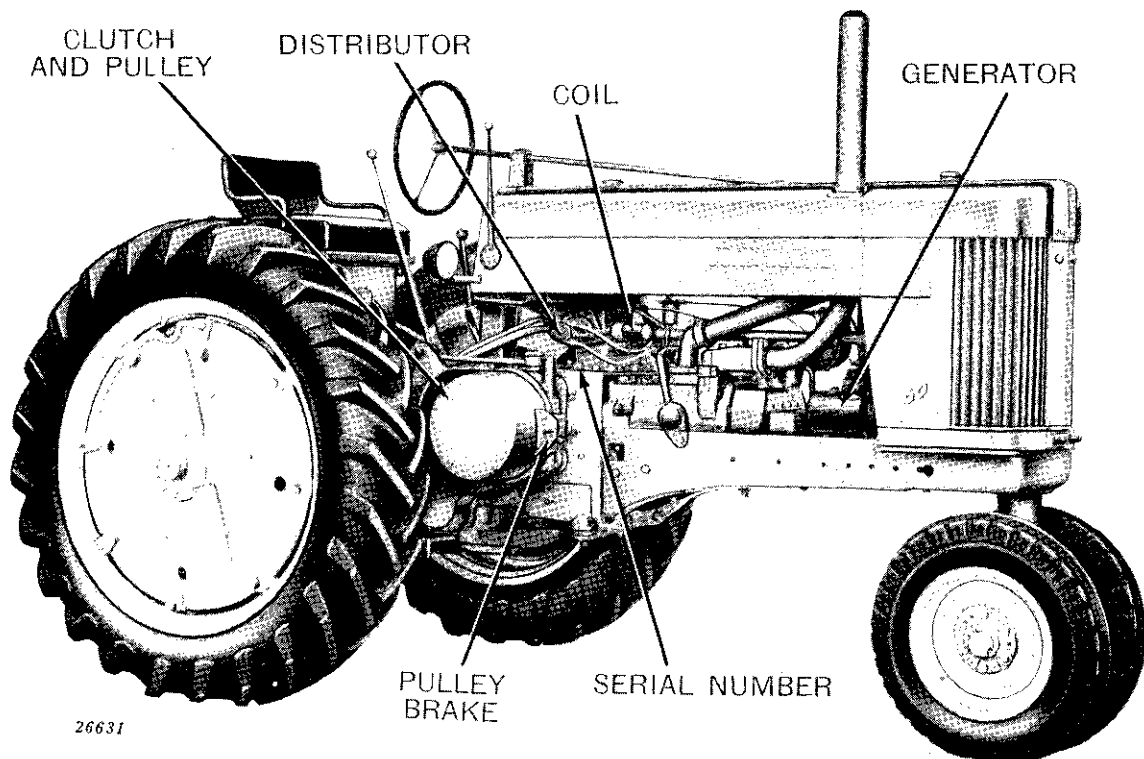

Figure 10-5-1—John Deere Model "60" Tractor—Pulley Side

### Fuel System.

Both gasoline and All-Fuel tractors are available.

Gasoline tractors are equipped with a dual-induction carbureting system using a gravity-fed, natural-draft, double-barrel carburetor and individually ported valves. The All-Fuel tractor uses a natural-draft, single-barrel carburetor. This tractor has two fuel tanks—a large tank for fuel and a small auxiliary tank for gasoline which is used when starting the All-Fuel engine.

An oil-wash air cleaner assures clean air for the engine.

### Ignition.

The tractor has a battery-distributor type ignition system with automatic spark advance. A 12-volt battery, generator, starter and lights are standard equipment. The lights consist of two front lights which can be made bright or dim, and a rear combination white and red warning light.

### Cooling System.

The engine is water cooled. The cooling system includes a centrifugal-type water pump and a thermostatically controlled shutter.

### Clutch.

A dry disk, hand-operated clutch is enclosed within the belt pulley. The clutch contains four 10-inch dry disks. The belt pulley is engaged by the clutch lever and rotates at crankshaft speed whenever the clutch is engaged. When the clutch is disengaged, an adjustable pulley brake prevents pulley rotation.

### Transmission and Differential.

The transmission lies crosswise in the main case. Shifting through the entire range of six forward speeds and one reverse speed is accomplished by one shift lever.

The differential is of the conventional type with a ring gear and spider driven directly by a spur gear in the transmission.

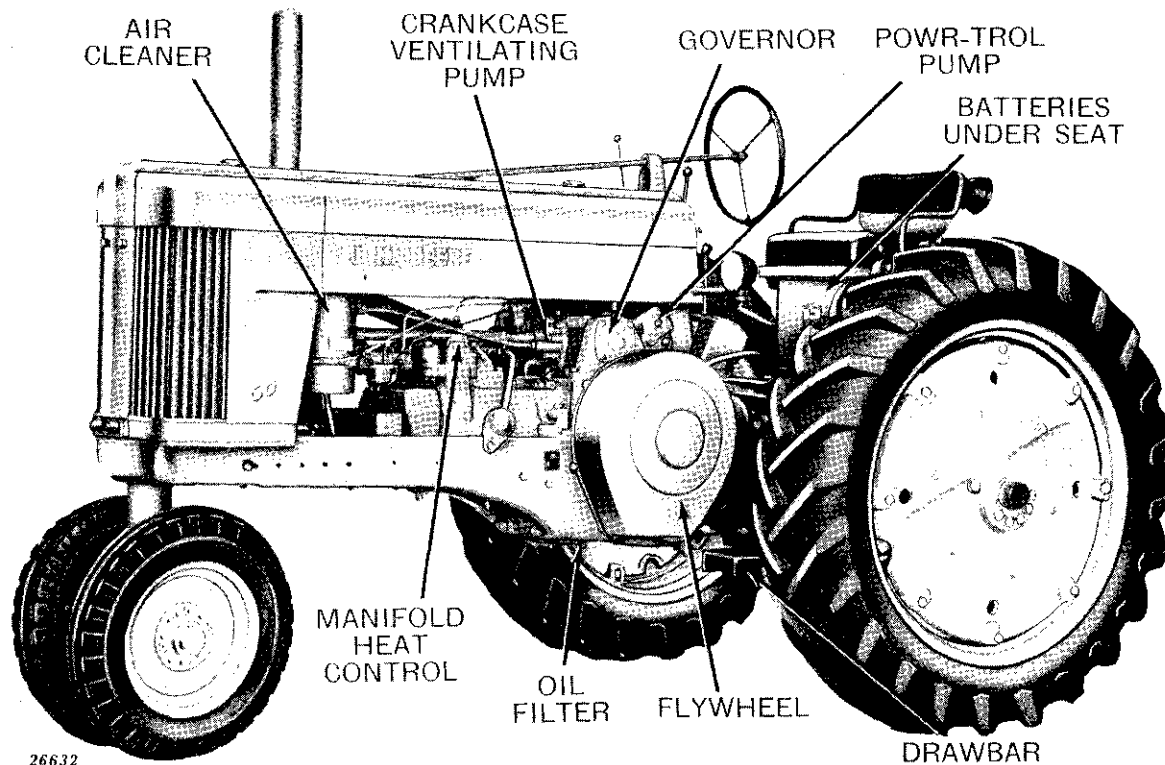

Figure 10-5-2—John Deere Model "60" Tractor—Flywheel Side

### Brakes.

Two individually operated foot brakes are provided to stop the tractor or hold it on inclines. Each brake has two internal-expanding brake-lined shoes and a drum with a shaft and gear which meshes with the final drive gear on either side.

### Front Wheel Assemblies.

The tractor may be equipped with a variety of front wheel assemblies. These include the Roll-O-Matic, standard dual front wheel, wide adjustable front axle, single front wheel, and 38-inch fixed tread. The wide adjustable front axle provides a tread range from 56 to 80 inches in 4-inch steps.

### Rear Wheels.

Rear wheel tread adjustment is made by a pinion located in the wheel hub which engages a rack on the axle. Extreme adjustments are made by changing the position of the rim and tire on the wheel.

The tractor may be equipped with *regular-*

*length* rear axles or *long* rear axles. With regular axles and 38-inch tires the tread range is 56 to 88 inches. With long axles and 38-inch tires the tread range is 62½ to 97¾ inches. If the tractor has long axles and 42-inch tires the tread can be adjusted from 56 to 104 inches.

### Power-Take-Off Shaft.

Two types of power take-off shaft are available: the conventional transmission-driven type, and optional, engine-driven "live" type with self-contained clutch permitting operation of P.T.O. equipment independently of tractor ground travel. Both types of shaft conform to A.S.A.E. standards.

### Hydraulic System.

The tractor may be equipped with Powr-Trol which raises, lowers, or sets integral implements at any desired depths. An implement-mounted remote cylinder may be used with Powr-Trol. The gear type hydraulic pump is mounted on the rear of the governor case and is driven through an idler gear by the camshaft.

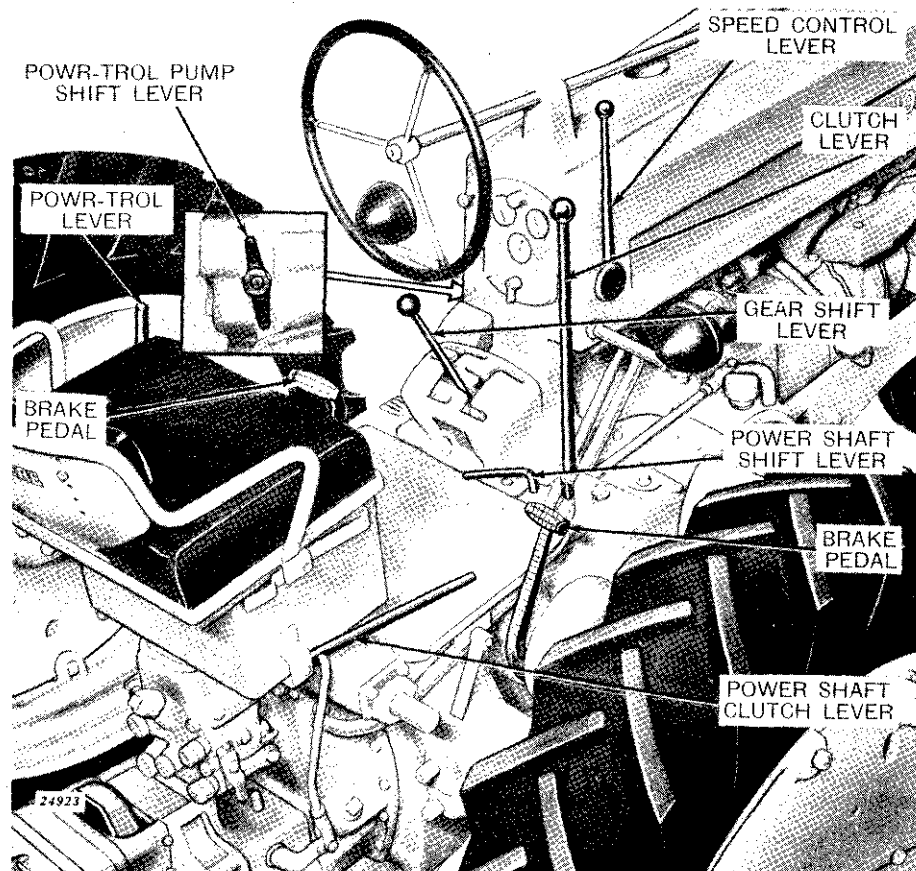

Figure 10-5-3—Operating Controls

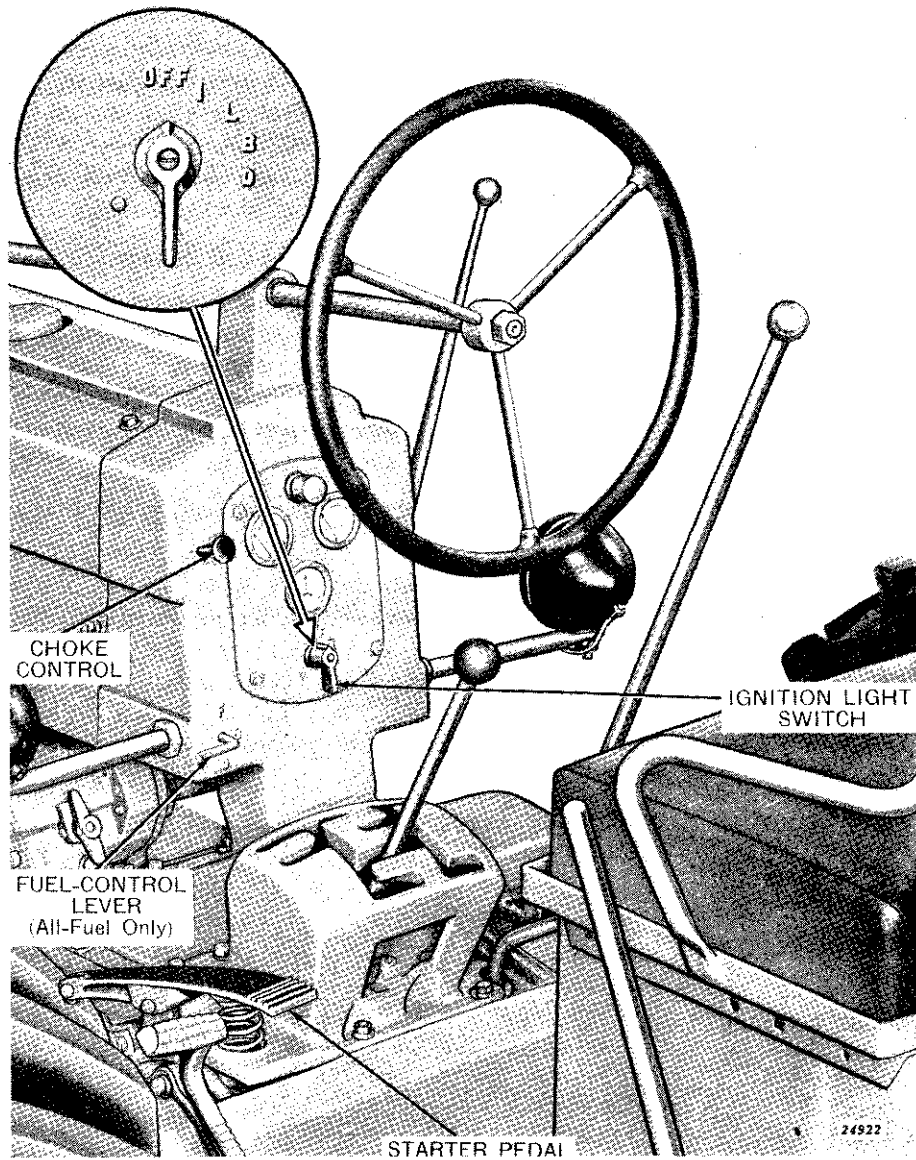

Figure 10-5-4—Starting Controls

## Group 10 SPECIFICATIONS

**PERFORMANCE:**

**Capacity for Work:**

Two 16-inch plow bottoms or a two-bottom bedder under normal conditions. Three 14-inch plow bottoms or a four-bottom bedder under favorable soil conditions.

**Maximum Belt Horsepower:**

Gasoline .....  
All-Fuel .....

**Maximum Drawbar Horsepower:**

Gasoline .....  
All-Fuel .....

**Maximum Pull:**

(2nd Gear)  
Gasoline .....  
All-Fuel .....

(Tractor not tested at Nebraska.)

**CAPACITIES (U. S. MEASUREMENTS):**

**Gasoline Tank:**  
Gasoline Tractor ..... 20-1/2 Gals.  
All-Fuel Tractor ..... 1 Gal.  
**Fuel Tank (All-Fuel)** ..... 20-1/2 Gals.  
**Crankcase** ..... 8 Qts.  
**Transmission** ..... 7 Gals.  
**Powr-Trol** ..... 6 Qts.  
**Power Shaft Clutch** ..... 1-3/4 Qts.  
**Remote Cylinder** ..... 1 Qt.  
**Cooling System** ..... 8-1/4 Gals.

**SPEEDS:**

Gear	11-38 Tires	11-42 Tires
1	1-1/2 mph	1-1/2 mph
2	2-1/2 mph	2-3/4 mph
3	3-1/2 mph	3-3/4 mph
4	4-1/2 mph	4-3/4 mph
5	6-1/4 mph	6-3/4 mph
6	11 mph	11-3/4 mph
Reverse	3 mph	3-1/4 mph

**ENGINE:**

Type ..... Two-cylinder, cast-in-block, valves-in-head.

**Engine Speeds:**

Load ..... 975 rpm  
Idle ..... 1115 rpm

Bore and Stroke ..... 5-1/2" x 6-3/4"

Displacement ..... 321 cubic inches

**Compression Ratio:**

Gasoline ..... 6.1 to 1  
All-Fuel ..... 4.50 to 1

**LUBRICATION SYSTEM:**

Type ..... Full force-feed pressure system with Purolator oil filter element.

**FUEL SYSTEM:**

Type ..... Gravity feed  
Carburetor:  
Gasoline ..... Natural-draft duplex type  
All-Fuel ..... Natural-draft type  
Air Cleaner ..... Oil-wash type

**COOLING SYSTEM:**

Type ..... Centrifugal pump and thermostatically controlled shutter.

**IGNITION SYSTEM:**

Type ..... Battery-Distributor  
Distributor Point Gap ..... .022"  
Spark Plugs:  
Size ..... 18 mm.  
Spark Plug Gap ..... .030"

**ELECTRICAL SYSTEM:**

Battery Voltage ..... 12 Volts  
Generator Regulation ..... Current Voltage Regulator.  
Battery ..... Group I

**CLUTCH:**

Type ..... Hand-operated, four 10-inch dry disks.

**BELT PULLEY:**

Diameter ..... 12-13/16"  
Width ..... 7-3/8"  
Rpm (Load) ..... 975  
Belt Speed ..... 3270 feet per minute

**TRANSMISSION:**

Type ..... Six speeds forward and one in reverse.  
Gears ..... Selective-type, straight spur-cut gears, forged and heat-treated.  
Bearings ..... Shafts operate on three roller bearings, four tapered roller bearings, and five ball bearings.

(Continued on next page)



## Section 20

# PREPARING THE TRACTOR FOR DELIVERY TO THE CUSTOMER

### (Off the Car or Truck)

### Group 5

Each Model "60" Tractor is manufactured with care and precision. Before it leaves the factory it is thoroughly inspected, adjusted, and tested.

However, during shipment and storage, many situations exist which may affect the general condition of the tractor. It is therefore important that the tractor be inspected thoroughly, and adjusted if necessary, before it is delivered to the customer.

By following the procedures given in this *Section*, you can be certain that the tractor is delivered in tip-top condition—ready to perform the work for which it was built. You will save time and money by avoiding after-delivery com-

plaints and service calls which will result if the tractor is not correctly adjusted when it leaves your shop. Above all, you can be sure of a satisfied customer when he puts the tractor to work.

Instructions pertaining to the preparation of tractors for temporary or permanent storage, and steps required to remove tractors from storage can be found under "*Tractor Storage*" in the "*Tractors and Engines (General)*" Unit of the Service Manual.

The chart below is a quick reminder of all points which should be checked or inspected prior to delivery. Detailed instructions for the less experienced serviceman follow the chart.

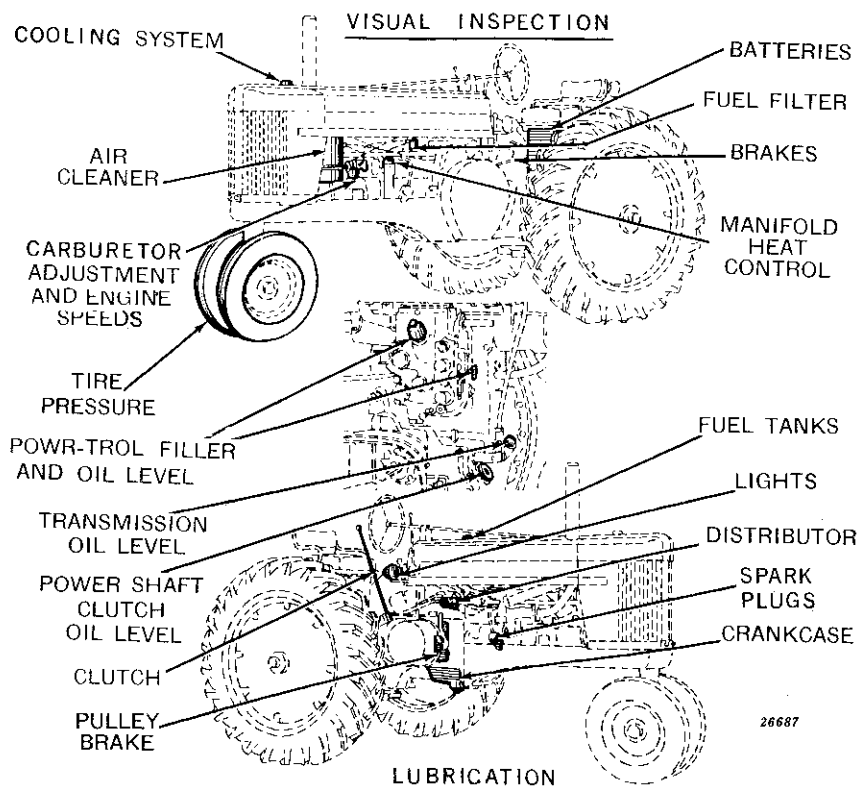

Figure 20-5-1—Pre-Delivery Check Points



### VISUAL INSPECTION.

When the tractor is received, inspect it carefully, tightening all bolts, nuts, and cap screws. Note any dents, scratches, or other damage which may have occurred in transit. Repair or replace all damaged parts before the tractor is delivered.

### COOLING SYSTEM.

Be sure that drain plug is installed in bottom of cylinder head and fill radiator with clean soft water or anti-freeze solution. Capacity of the cooling system is 8-1/4 U. S. gallons.

### TIRES.

When tractors are shipped from the factory the tires are overinflated to prevent possible damage to the tractors while in transit. Check the pressure in the tires and deflate them to the correct operating pressure as shown in the chart below.

### RUBBER TIRE INFLATION CHART

#### Rear Tires

Tire Size	Ply	*Inflation Pressure Without Added Wheel Weight	Maximum Permissible Additional Weight per Wheel at Maximum Recommended Inflation Pressure
11-38	6	12 lbs.	500 at 16 lbs.
12-38	6	12 lbs.	800 at 14 lbs.
9-42	6	20 lbs.	300 at 24 lbs.
11-42	6	12 lbs.	500 at 16 lbs.

#### Front Tires

6.00 x 16, 4-Ply—28 lbs.
6.00 x 16, 6-Ply—36 lbs.
7.50 x 16, 8-Ply—36 lbs.
9.00 x 10, 8-Ply—44 lbs.

*\*If the tractor is to be used for plowing advise the operator to increase the pressure in the furrow rear tire 4 pounds.*

and check the specific gravity of the electrolyte. It should be checked with an accurate hydrometer before adding water (Figure 20-5-2).

If liquid level is too low to check, add distilled water and run the engine for a few minutes permitting the water and electrolyte to mix; then check. Specific gravity should not go below 1.225 which is half charge. When fully charged the reading will be 1.240 to 1.255. Grease the terminal posts to reduce corrosion.



Figure 20-5-2—Checking Specific Gravity of Battery with a Hydrometer

### AIR CLEANER.

Remove the air cleaner cup (Figure 20-5-3) and note oil level. If it is low, add clean SAE 10-W oil until the level is even with the oil level mark on the cup.



### CRANKCASE OIL LEVEL.

Check the crankcase oil level by opening the test cock (Figure 20-5-4). If oil does not run out, add a good grade of SAE 10-W oil until it runs out of the test cock.

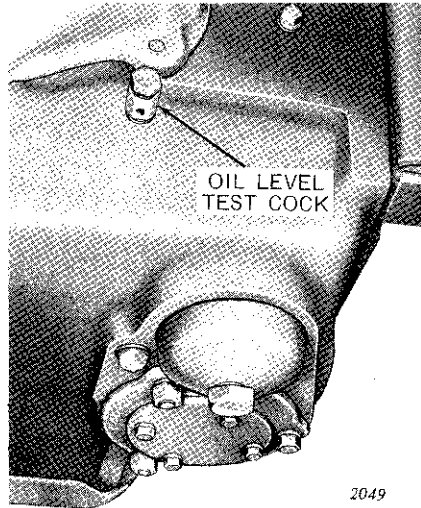

Figure 20-5-4—Crankcase Oil Level Test Cock

### TRANSMISSION OIL LEVEL.

The transmission should be full of oil up to the filler plug (Figure 20-5-5). If necessary, add a good grade of SAE 90 transmission oil until its level is satisfactory. (Use SAE 80 oil if prevailing temperatures are below 0° F.)

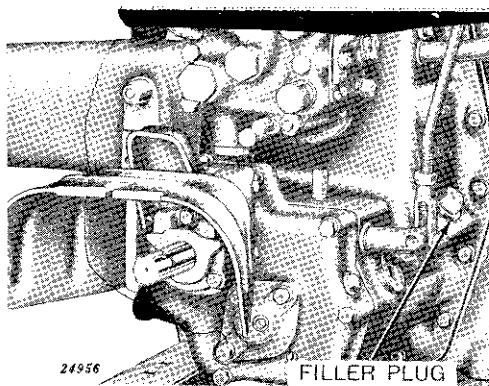

Figure 20-5-5—Transmission Filler Plug

### POWR-TROL OIL LEVEL.

If the tractor is equipped with Powr-Trol, open the oil level cock (Figure 20-5-6) and see if oil runs out. If it does not, add good clean SAE 10-W oil at the filler plug until it runs out at the test cock.

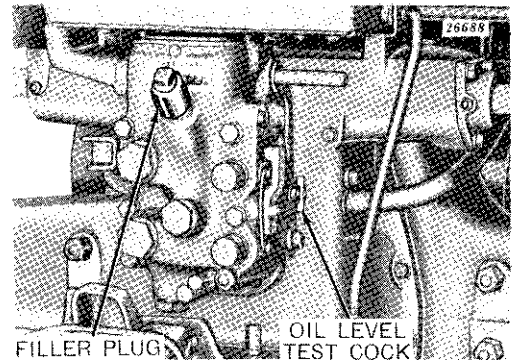

Figure 20-5-6—Powr-Trol Oil Level Test Cock and Filler Plug

### POWER SHAFT CLUTCH OIL LEVEL.

If the tractor is equipped with an engine-driven "live" power shaft, check the oil level in the clutch by removing the filler plug (Figure 20-5-7). If oil does not run out, add good clean SAE 10-W oil until it does.

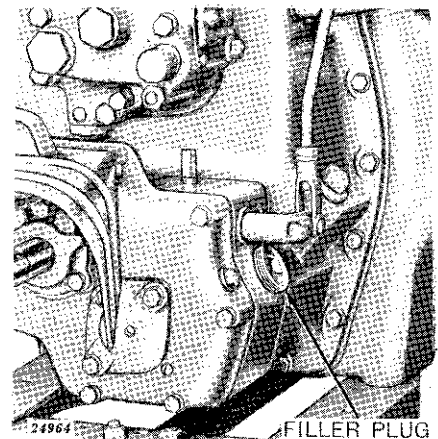

Figure 20-5-7—Power Shaft Clutch Filler Plug

**MANIFOLD HEAT CONTROL.**

When preparing a gasoline-burning tractor for delivery, check position of the manifold heat control valve (Figure 20-5-8). If the prevailing temperature is above 32° F. turn the valve to the "COLD" position by loosening the clamp which holds it in place. If the prevailing temperature is below 32° F. turn the valve to the "HOT" position. *Be sure "V" marks on valve and side of manifold line up before tightening clamp. Since the manifold heat control valve is a two-position valve only, do not set it in any intermediate position; otherwise damage to the engine may result. Never attempt to change the control with the engine running.* Advise the operator to set the valve in the "COLD" position regardless of temperature if the tractor is to be used continuously under full load.

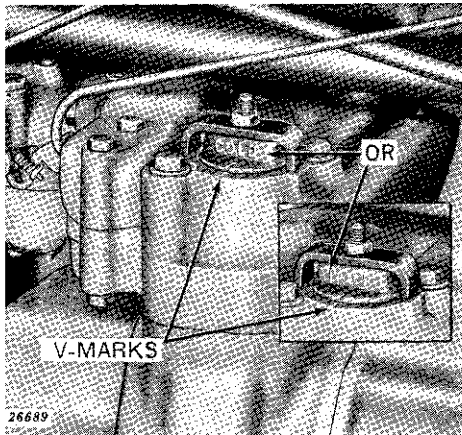

Figure 20-5-8—Manifold Heat Control Valve

**DISTRIBUTOR.**

Remove distributor cap, arm, and cover (Figure 20-5-9). Turn flywheel until cam opens points to widest position. Using a feeler gauge measure point gap and adjust to .022-inch if gap is not correct.

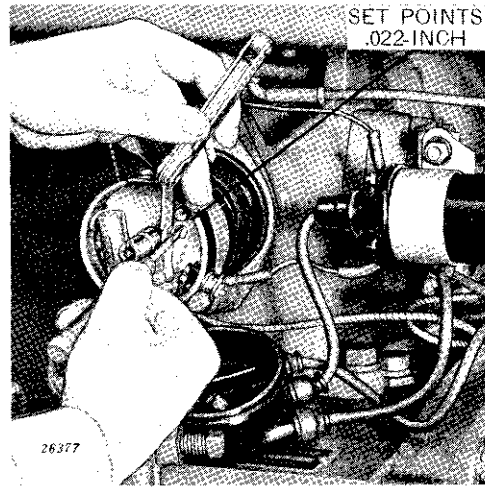
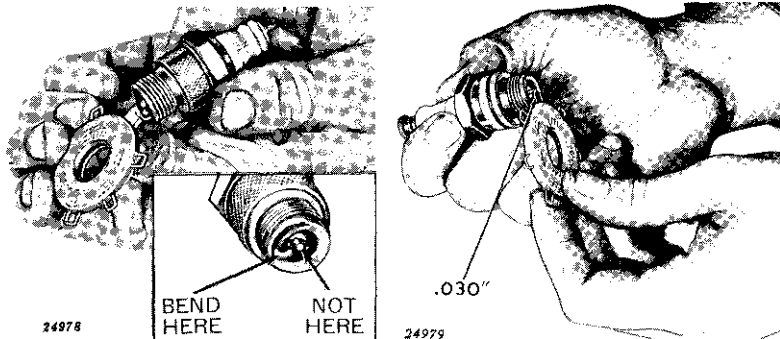

Figure 20-5-9—Adjusting Distributor Point Gap

Reinstall all distributor parts. Upper cap terminal wire goes to spark plug on flywheel side of tractor.

**SPARK PLUGS.**

Remove each spark plug and check the gap for .030-inch between electrodes. Adjust the gap if it is not set properly (Figure 20-5-10).



Setting Point Gap

Checking Point Gap

Figure 20-5-10—Adjusting Spark Plug Gap

**FUEL TANKS.**

Use only good clean fuel in the tractor. Capacity of the main tank for both gasoline and All-Fuel tractors is 20-1/2 U.S. gallons. Capacity of the auxiliary tank on All-Fuel tractors is 1 U.S. gallon.

### FUEL FILTER.

If glass filter bowl beneath the gasoline tank shows water or sediment, turn off the gasoline supply, remove and clean the glass bowl and screen. Use a good gasket when replacing the filter bowl.

### ENGINE SPEEDS.

After completing the tests and services listed above, start the engine and permit it to reach operating temperature.

As soon as the engine is started look at the oil pressure gauge to make sure the engine lubrication system is working properly. If the gauge does not register pressure turn the engine off immediately and determine the cause.

Check slow and fast idle speeds and the load speed using a revolution counter on the end of the belt pulley. Both gasoline and All-Fuel engines operate at the same speeds as follows:

Slow Idle— 600 rpm  
Fast Idle—1115 rpm  
Load — 975 rpm

If any of the above speeds is incorrect, make adjustments according to instructions in *Section 40* of this manual.

### CARBURETOR ADJUSTMENTS.

With engine running, note the idling characteristics. If the engine does not idle smoothly, adjust the carburetor load and idle needles as explained in *Section 40* of this manual.

### CLUTCH OPERATION.

The clutch should go into engagement with a snap requiring 60 to 90 pounds pressure on the end of the lever. If adjustment is incorrect, remove the pulley cover, engage the clutch, and tighten the three slotted nuts (Figure 20-5-11) a little at a time to maintain equal tension until adjustment is correct. Make a final check of clutch operation after the engine is running.

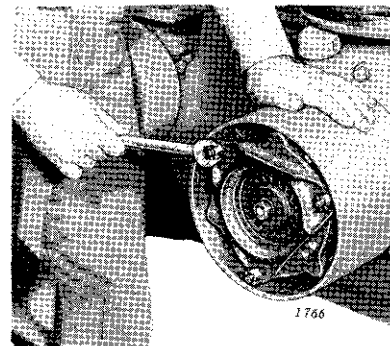

Figure 20-5-11—Adjusting the Clutch

### PULLEY BRAKE.

With the engine running, test the pulley brake to see that it is adjusted properly. This adjustment is important because the pulley brake not only stops the pulley from turning when the clutch is disengaged, but it also insures positive disengagement of the clutch when the clutch is released. The pulley brake should be adjusted so that when the clutch lever is moved slightly forward from the rear, the pulley is free to turn. To make the adjustment, move clutch lever forward just to point of engagement, hold the pulley brake tightly against the pulley, and turn the adjusting screw (Figure 20-5-12) until there is approximately 1/8-inch clearance between the end of the screw and the operating pin in the pulley.

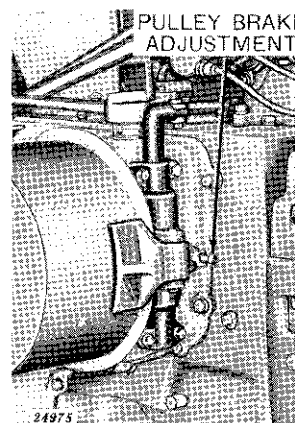

Figure 20-5-12—Pulley Brake Adjusting Screw

### REAR WHEEL BRAKES.

Test the brakes to be sure they work properly. Each brake pedal should have 2-3/4- to 3-1/4-inch free movement before the shoe contacts the drum. If necessary, adjust the brakes by tightening the adjusting screw and backing it off 5 notches (Figure 20-5-13).

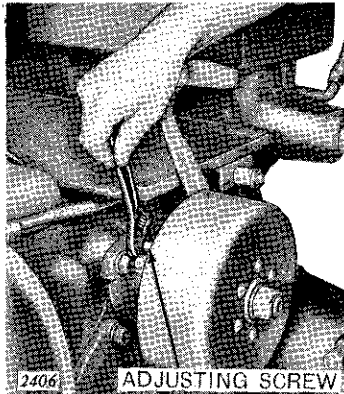

Figure 20-5-13—Adjusting Rear Wheel Brake

### WHEEL WEIGHTS.

If the customer has specified cast-iron wheel weights or calcium chloride in the tires, be careful to install them properly. See *Section 160* for suggestions regarding the use of a tire gauge and the installation of weights. The last column in the chart on page 20-5-2 shows the maximum amount of weight that can be added to the wheels. If weights are added, recheck the tire pressure.

### LIGHTS.

Turn on the combination ignition-light switch (Figure 20-5-14) to see that the lights are working properly. The five positions provide the following:

- “OFF”—Both ignition and lights off
- “I” —Ignition only
- “L” —Bright front lights and white rear light
- “B” —Bright front lights and red rear light
- “D” —Dim front lights and red rear light

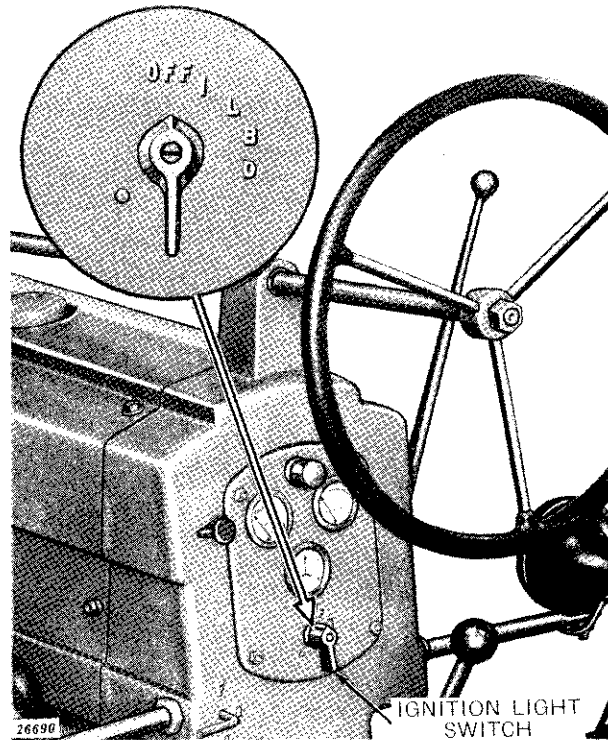

Figure 20-5-14—Combination Ignition-Light Switch

### LUBRICATION.

Lubricate the entire tractor using the chart in Figure 20-5-16 on the next page as a guide to the location of grease fittings.

When all inspections and services in the above paragraphs are completed, the tractor will leave your shop in the best of condition, ready to perform dependably and economically.

### DISCUSSING THE TRACTOR WITH ITS NEW OWNER.

Before releasing the tractor to its new owner, discuss with him the valuable information contained in the Operator's Manual. A list of the most important items and operations with which the owner should be familiar will be found on page 3 of the Operator's Manual.

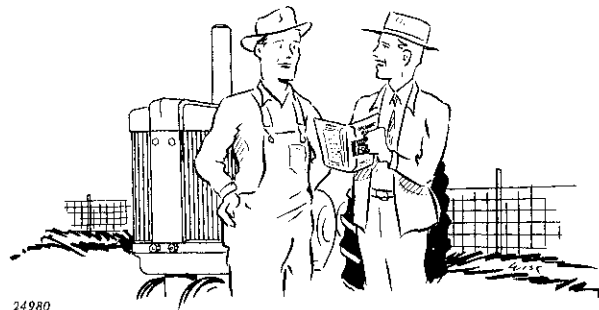
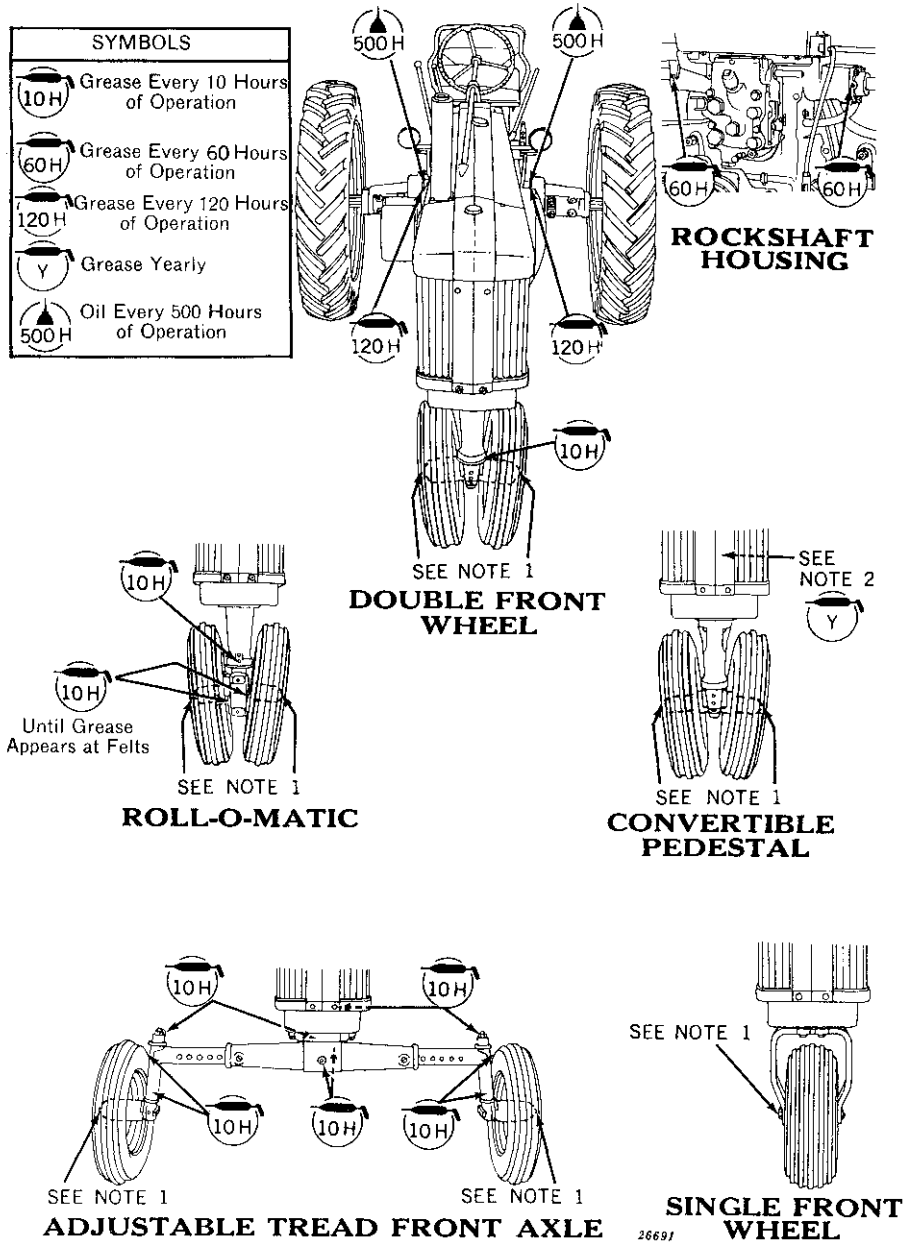

Figure 20-5-15—Discussing the Operator's Manual with the New Owner



**NOTE 1:** Front wheels are packed with wheel bearing grease at the factory and need cleaning and repacking every 6 months under normal conditions.

Where there is danger of mud and water getting into the front wheel bearings due to operation in extremely wet and muddy conditions, advise operator to grease front wheels (except single front wheel type) every 10 hours with gun grease until the wheels can be removed and bearings cleaned and repacked with wheel bearing grease.

**NOTE 2:** It is not necessary to lubricate the lower bearing on convertible pedestal prior to delivery of tractor.

Figure 20-5-16—Lubrication Chart



## Section 40

# TRACTOR TUNE-UP AND ADJUSTMENTS

### Group 5 PROCEDURE

Tune-up of a John Deere tractor constitutes an orderly sequence of diagnosing troubles and making minor repairs and adjustments for efficient and economical operation of the tractor and its accessories. The procedure as outlined for each system of the tractor has proved to be most successful. Therefore, we recommend that it be followed. Deviation from this sequence could result in misadjustment and customer dissatisfaction.

In the case of the Model "60" engine, this means servicing the ignition and electrical, air cleaning, cooling, carburetion, fuel and lubrication systems; adjusting tappet clearance, brakes, both engine and power shaft clutches and all operating linkage.

Fundamentally, a badly worn engine cannot be tuned up; therefore, certain inspections and tests must be made to determine whether a major overhaul is necessary or whether a tune-up will accomplish most efficient and economical operation.

Generally the customer complaint will determine which system or part of the tractor should be checked first, but within the prescribed outline of each system, the sequence of checking and adjusting must be followed.

#### VISUAL INSPECTION

First, before even starting the tractor engine, a visual inspection can give definite clues to the condition of the tractor.

##### Fuel System.

Inspect the fuel system by beginning at the air cleaner. Note whether radiator screen is partially clogged and condition of air intake tube. Inspect condition of air cleaner itself and connections. If the proper amount of thoroughly cleaned air does not reach the carburetor, performance of engine is greatly affected.

Check the fuel tank, lines, and connections for restriction or leakage.

Inspect fuel filter for dirt and leakage between gasket and body.

Inspect carburetor for evidence of gas leakage or flooding and check condition of choke and throttle lever shafts.

Check the throttle and choke control linkage for excessive wear or binding.

Inspect for evidence of manifold leaks due to cracks or blown gaskets.

##### Ignition System.

Note general condition of wiring ground strap and cable, whether oil soaked, frayed or damaged insulation and excessive corrosion.

Inspect coil for damage, accumulated dirt, grease and proper mounting.

Check the distributor for cracked cap, condition of gasket, excessive dirt or grease and proper mounting.

Note battery for excessive corrosion, cracked case, correct caps, amount of electrolyte, proper mounting and cable connections.

Inspect starter and generator for excessive dirt and grease, loose cable and wiring conditions. Note whether covers are in place and mounting is correct. Check condition and adjustment of generator drive belt.

##### Cooling System.

Inspect radiator screen for clogging or damage.

Look at radiator carefully for evidence of leakage, clogging of air spaces between fins and condition of fins.



Examine shutter and shutter control linkage.

Note water pump for leakage and condition and adjustment of water pump drive belt.

Inspect radiator hoses for "mushy" condition, indicating need for replacement.

Check cylinder head gasket and water pipe connections to block for evidence of leakage.

### Lubrication System.

Check all parts of engine, transmission, Powr-Trol housing, and power shaft clutch housing for evidence of excessive oil leakage.

Inspect outer ends of rear axle housing for evidence of oil leaking indicating worn seals between axle and housing.

Note inside front wheels for excessive amount of grease leakage at seals.

Look for oil leakage around bottom of vertical steering shaft at pedestal, indicating oil leakage by "O" ring in pedestal.

## INSPECTION OF ENGINE CONDITION

First of all, determine whether a tune-up will bring the engine up to peak efficiency of operation.

Three important conditions are necessary to efficient and economical engine performance. Sufficient compression, proper ignition, and correct air-fuel mixture delivered to each combustion chamber.

Sufficient compression can only be obtained by a major overhaul, if engine parts are excessively worn.

To make the compression test the engine must be at normal operating temperature. Start the engine and note the following while the engine is warming up:

Check oil pressure at starting and later at operating speed of 1115 R.P.M.

Remove the radiator cap and note whether any bubbles appear in coolant. If bubbles appear, it indicates a head gasket blown between cylinder

wall and water passage allowing compressed gas from cylinder to be forced into water.

### COMPRESSION TEST.

When the engine has reached operating temperature, check to see that throttle can be opened completely because the compression test is affected by the volume of air reaching cylinders.

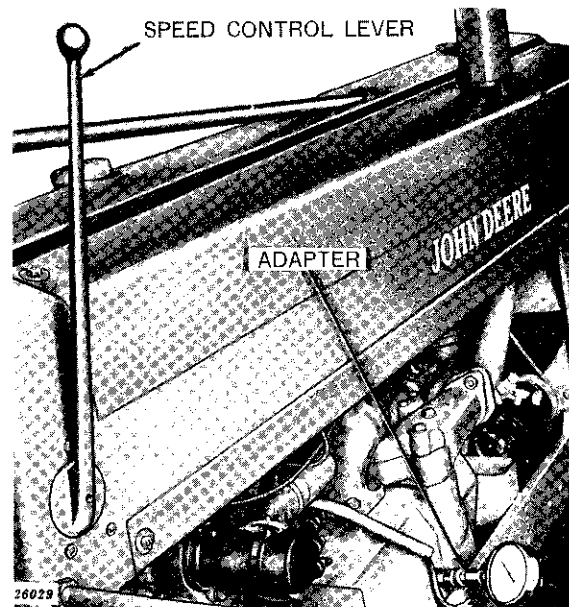

Figure 40-5-1—Testing Compression

Shut off the engine, remove spark plugs and install pressure gauge into a spark plug hole (Figure 40-5-1), using adapter. *NOTE: Make certain all connections are tight to prevent any pressure leakage.*

Disengage clutch and crank engine with starter, advancing throttle lever to wide open position. Continue cranking engine several seconds and observe pressure gauge readings. In a new engine with rings seated the compression pressure is 110 P.S.I. If the pressure is found to be much lower than this, remove gauge and apply oil to ring area of piston through spark plug hole, being careful not to get oil on valves and test compression again. If the pressure is higher it indicates worn or stuck piston rings. Repeat this test on the other cylinder. Pressures should not vary more than 10 pounds between cylinders at any time.

If pressure is low and oil was applied to rings, cylinder rechecked and still found low, probably valves are worn or sticking. Low pressures could indicate any one of these things or a combination of worn cylinder and rings, valves worn, burned, or sticking.

An engine with excessively low pressure must be reconditioned before a tune-up can be accomplished.

By hand cranking the engine much can be learned of its condition. The engine will rotate with practically no resistance if compression pressure is low in both cylinders. With pressure low in one cylinder it can be felt by resistance when the good piston is coming forward on compression stroke. If the intake or exhaust valves are leaking, this can be heard while hand cranking.

If the pressure was found to be good in both cylinders, tune-up the engine by the following procedure:

## ELECTRICAL AND IGNITION SYSTEM

While spark plugs are out, check, clean and re-gap plugs according to instructions in *Electrical Equipment, Section 40* of the "Tractors and Engines (General)" unit of the Service Manual. Electrode gap of spark plugs should be .030 inch. Install spark plugs using new gaskets and tighten to 32 foot pounds.

If tractor is equipped with magneto ignition, refer to *Section 40, Group 25* of the "Tractors and Engines (General)" unit of the Service Manual.

Test ignition and electrical circuits by referring to *Section 40, "(General)" Unit* of Service Manual.

Inspect battery and cables according to instructions in *Section 40, "(General)" Unit* of Service Manual.

If specific gravity of battery is low recharge battery.

Test and adjust or repair starter, generator and distributor following instructions in *Section 40, "(General)" Unit*.

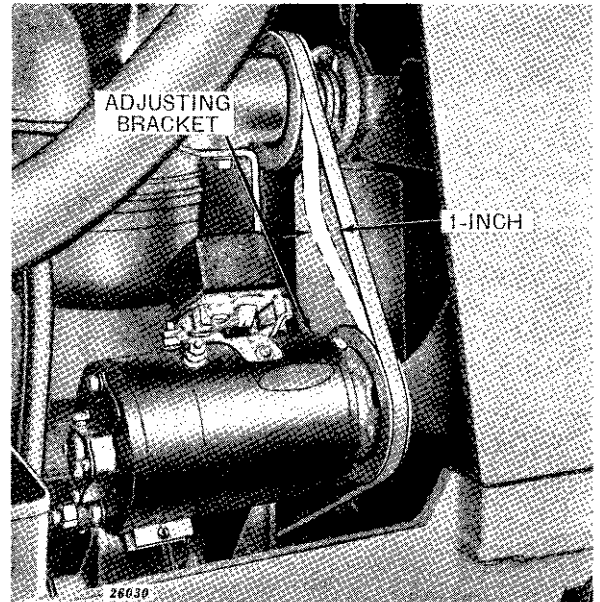

Figure 40-5-2—Generator Belt Adjustment

Adjust generator belt tension so that slack between fan and generator pulleys can be flexed one inch at center (Figure 40-5-2).

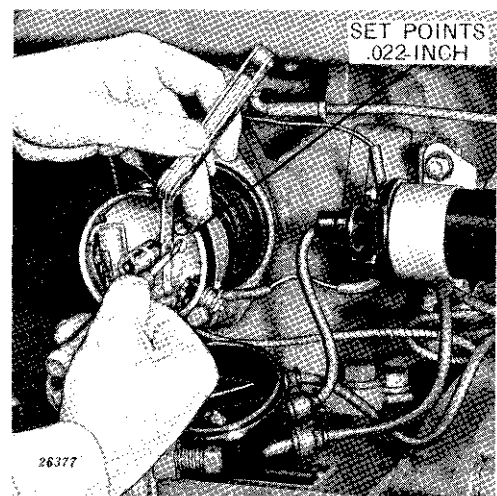

Figure 40-5-3—Adjusting Distributor Breaker Point Gap

The distributor rotates counter-clockwise, viewed from drive end and employs an automatic spark advance of 25 degrees. Set point gap at .022-inch



**Suggest:**

**If the above button click is invalid.**

**Please download this document first, and then click the above link to download the complete manual.**

**Thank you so much for reading**

### TIMING DISTRIBUTOR WITH ENGINE.

Remove spark plug from flywheel side and hold thumb over spark plug hole while rotating engine in running direction. Continue rotating engine until air pressure is felt against thumb, which indicates piston is moving forward on compression stroke. Rotate engine until "TDC" mark on outside diameter of flywheel aligns with notch in timing hole of flywheel cover (Figure 40-5-4). With the engine in this position the slot in coupling of drive flange will be horizontal (Figure 40-5-5).

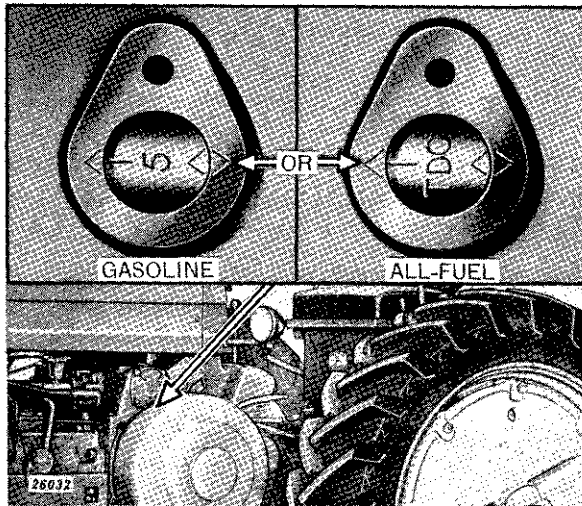

Figure 40-5-4—Timing Mark Aligned on Flywheel

Remove distributor cap and turn distributor arm to a vertical position (Figure 40-5-5). (Distributor held so that when distributor cap is in place, high tension wire outlets are toward front of tractor).

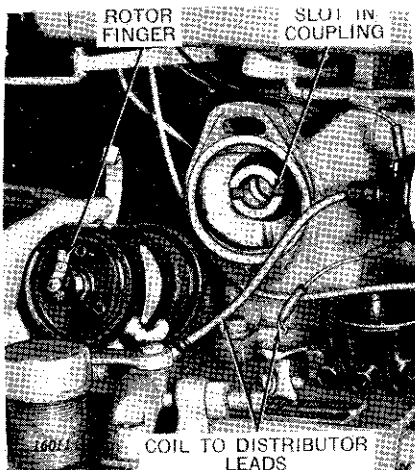

Figure 40-5-5—Timing Distributor

This places the coupling lugs of the distributor in a horizontal position to align with the slot on the drive flange and in position for the upper spark plug cable to fire No. 1 cylinder.

Mount distributor and gasket on governor case, making sure driving lugs engage slots on distributor drive flange.

After tightening two mounting cap screws firmly with fingers, connect coil to distributor lead. Rotate distributor approximately 1 inch toward front of tractor. Install cap on distributor and insert a wire suitable for observing spark in upper spark plug wire terminal cover and bend to within 1/8 inch of a metallic part of tractor.

### For All-Fuel Engines.

After making sure "TDC" mark is still in line with notch in timing hole in flywheel cover, turn on ignition switch and slowly tap top of distributor toward rear of tractor until a spark is produced between the wire and a metallic part of the tractor.

Tighten cap screws holding distributor to governor case and install spark plug cables. Install left-hand spark plug cable in upper distributor cap terminal.

When using timing light, adjust distributor so that the 25-degree mark on outside diameter of flywheel is in line with the notch in flywheel cover when engine is operating at fast idle (1115 R.P.M.)

### For Gasoline Engines.

Turn flywheel in running direction from the position "TDC" compression stroke in line with notch in timing hole in flywheel cover until mark 5-degree "ATDC" lines up with the notches. Tap top of distributor toward rear of tractor until spark is produced between wire and metallic part of the tractor. Tighten cap screws holding distributor to governor case and install spark plug cables. Left-hand spark plug cable is installed in upper distributor cap terminal

Use a timing light (Figure 40-5-6) and adjust distributor so that the 20-degree mark on the out-

**<https://www.ebooklibonline.com>**

Hello dear friend!

Thank you very much for reading.

Enter the link into your browser.

The full manual is available for immediate download.

**<https://www.ebooklibonline.com>**