

1350, 1550, 1750, 1850,
1850N, 1950, 1950N,
2250, 2450, 2650, 2650N,
2850, 3050, 3350 and
3650 Tractors

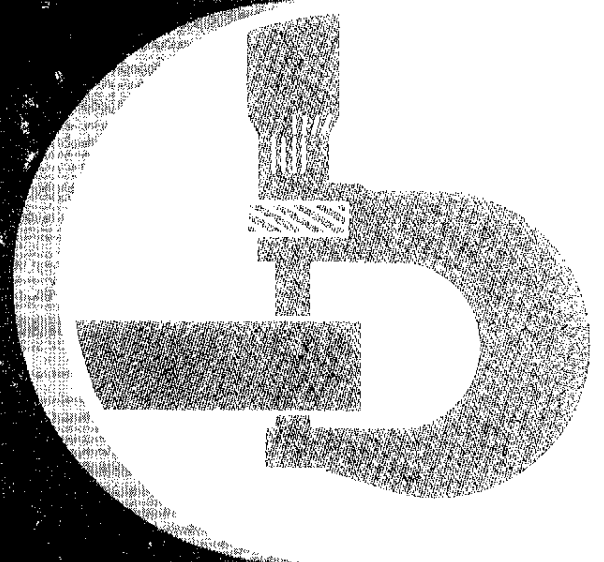

John Deere Werke Mannheim
TM4446
Printed in Germany (English)

Contents

1350 TO 3650 TRACTORS TECHNICAL MANUAL TM4446 (AUG-90)

SECTION CONTENTS IN GROUPS – OPERATION AND TESTS

210 – SAFETY

220 – ENGINE

- 05 – Radiator and viscous fan drive
- 10 – Tests

230 – FUEL AND AIR INTAKE SYSTEM

- 05 – Fuel tank, auxiliary fuel tank and water trap
- 10 – Cold weather starting aids
- 15 – Speed control linkage
- 20 – Air cleaner

240 – ELECTRICAL SYSTEM

- 05 – General
- 10 – Electrical diagrams (without cab)
- 15 – Circuit diagnosis (without cab)
- 20 – Sealed-beam lighting equipment
(see CTM-4459)
- 25 – Electrical diagrams (with MC1 cab)
- 30 – Circuit diagnosis (with MC1 cab)
- 35 – Electrical diagrams (with SG2 cab)
- 40 – Circuit diagnosis (with SG2 cab)
- 41 – Electrical diagrams (with digital
speed-hour meter)
- 42 – Circuit diagnosis (with digital
speed-hour meter)
- 45 – Testing components
- 50 – Starting motor
- 55 – Alternator

250 – POWER TRAIN

- 05 – Clutch operating linkages
- 10 – Single-stage engine clutch
- 15 – Dual-stage engine clutch
- 20 – Hi-Lo shift unit
- 25 – Creeper transmission
- 26 – Hydrostatic creeper transmission
- 30 – Transmission shift linkages
- 35 – Synchronized transmission and
transmission oil pump
- 40 – Collar shift transmission and
transmission oil pumps
- 45 – Differential
- 50 – Final drives
- 55 – Independent PTO's
- 60 – Continuous-running PTO's
- 65 – Front PTO
- 70 – Front wheel drive u.j. drive shaft
and disk clutch

260 – STEERING SYSTEM AND BRAKES

- 05 – Hydrostatic steering
- 10 – Power steering
- 15 – Manual steering
- 20 – Hydraulic brakes
- 25 – Handbrake
- 30 – Hydraulic trailer brake

INHALT-LB501AE-010490

SECTION CONTENTS IN GROUPS – OPERATION AND TESTS (CONTD.)

270 – HYDRAULIC SYSTEM

- 05 – Operation and tests
- 10 – Valves, filters, oil cooler and oil reservoir
- 15 – Hydraulic pumps
- 20 – Rockshaft
- 25 – Front hitch
- 30 – Selective control valves (spool type)
- 35 – Selective control valves (poppet valve type)
- 40 – ISO breakaway couplers
- 45 – ISO quick couplers
- 50 – Remote cylinder

290 – OPERATOR'S CABS

- 05 – Air conditioning system
- 10 – Cab ventilation and heating system – SG2 cab
- 15 – Cab ventilation and heating system – MC1 cab

<https://www.ebooklibonline.com>







Hello dear friend!

Thank you very much for reading.

Enter the link into your browser.

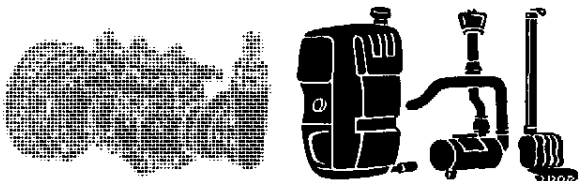
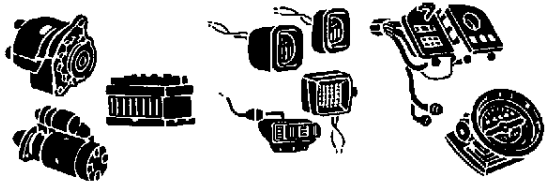
The full manual is available for immediate download.

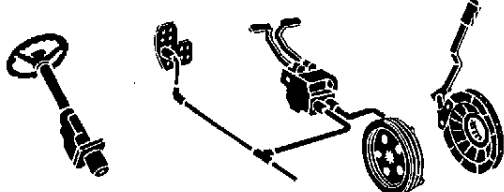
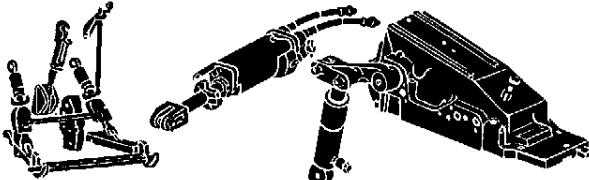
<https://www.ebooklibonline.com>

<p>SAFETY</p>		<p>210</p>
<p>ENGINE</p>		<p>220</p>
<p>FUEL AND AIR INTAKE SYSTEM</p>		<p>230</p>
<p>ELECTRICAL SYSTEM</p>		<p>240</p>
<p>POWER TRAIN</p>		<p>250</p>
<p>STEERING SYSTEM AND BRAKES</p>		<p>260</p>
<p>HYDRAULIC SYSTEM</p>		<p>270</p>
<p>OPERATOR'S STATION</p>		<p>290</p>

SAFETY AND YOU

This is the safety-alert symbol. When you see this symbol on the machine or in this manual, be alert to the potential for personal injury.



T 81389

T81389.053.TMSAFE 19 07OCT85

IMPORTANT

The **IMPORTANT** message identifies potential problems which may cause consequential damage to machine. Following recommended procedure will instruct technician how to avoid problem.

A68;N01;0000 19 U 05NOV82

NOTES

The word **NOTE** is followed by a statement that identifies a qualification or exception to a previous statement. A "**NOTE**" may also identify nice-to-know information pertinent to, but not directly related to previous statement.

A68; N01;0000 19 V 05NOV82

OBSERVE SAFETY RULES

Avoid loose clothing that can catch in moving parts and put you out of work.

Wear your safety glasses while on the job.

Avoid working on equipment with the engine running. If it is necessary to make checks with the engine running, ALWAYS USE TWO PEOPLE – with the operator, at the controls, able to see the person doing the checking. Also, put the transmission in neutral, set the brake, and apply safety locks provided. KEEP HANDS AWAY FROM MOVING PARTS.

Keep transmission and brake control units properly adjusted at all times. Before making adjustments, stop engine.

Before removing any housing covers, stop engine. Take all objects from your pockets which could fall into the opened housings. Don't let adjusting wrenches fall into opened housings.

Don't attempt to check belt tension while the engine is running.

Don't adjust the fuel system while the machine is in motion.

Before repairing the electrical system, or performing a major overhaul, make sure the batteries are disconnected.

A68; N01;0000 19 S 05NOV82

PREPARE FOR EMERGENCIES

Be prepared if a fire starts.

Keep a first aid kit and fire extinguisher handy.

Keep emergency numbers for doctors, ambulance service, hospital and fire department near your telephone.

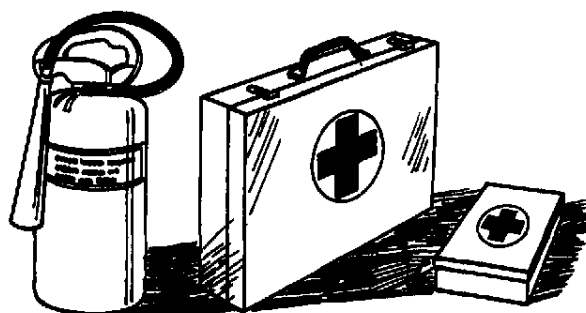

L 114 052

L114052;053;FIR2 19 15MAR89

WORK IN CLEAN AREA

Before starting a job:

- Clean work area and machine.
- Make sure you have all necessary tools to do your job.
- Have the right parts on hand.
- Read all instructions thoroughly; do not attempt shortcuts.

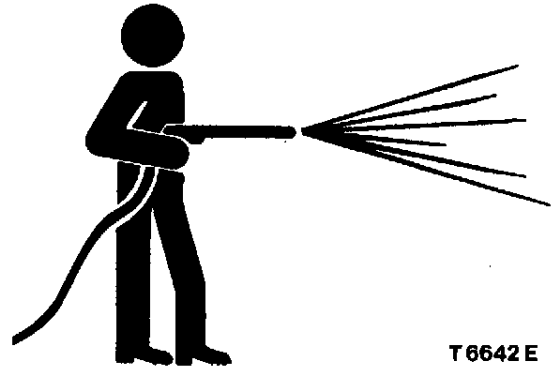

T 6642 E

T6642E 053 CLEAN 19 19JAN88

WORK IN VENTILATED AREA

Engine exhaust fumes can cause sickness or death. If it is necessary to run an engine in an enclosed area, remove the exhaust fumes from the area with an exhaust pipe extension.

If you do not have an exhaust pipe extension, open the doors and get outside air into the area.

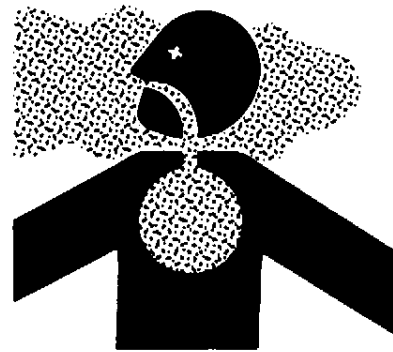

TS 220

TS220.053.AIR 19 05JAN88

PARK MACHINE SAFELY

Before working on the machine:

- Lower all equipment to the ground.
- Stop the engine and remove the key.
- Disconnect the battery ground strap.
- Hang a "DO NOT OPERATE" tag in operator station.

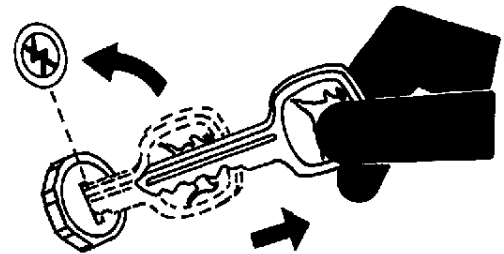

TS 230

TS230.053.PARK 19 05JAN88

USE PROPER LIFTING EQUIPMENT

Lifting heavy components incorrectly can cause severe injury or machine damage.

Follow recommended procedure for removal and installation of components in the manual.

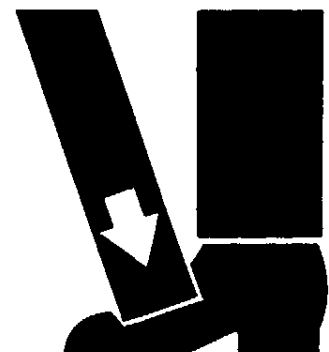

TS 226

TS226.053.LIFT 19 05JAN88

SUPPORT MACHINE PROPERLY

Always lower the attachment or implement to the ground before you work on the machine. If you must work on a lifted machine or attachment, securely support the machine or attachment.

Do not support the machine on cinder blocks, hollow tiles or props that may crumble under continuous load. Do not work under a machine that is supported solely by a jack. Follow recommended procedures in this manual.

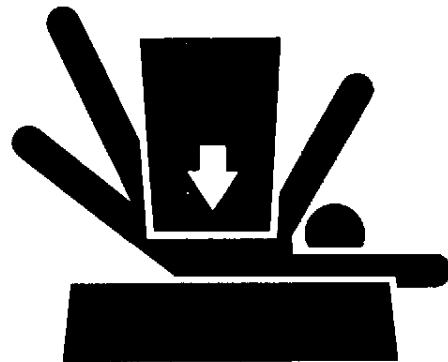

TS 229

TS229 043 LOWER 19 21 DEC 87

SERVICE FRONT-WHEEL DRIVE TRACTOR SAFELY

When servicing front-wheel drive tractor with the rear wheels supported off the ground and rotating wheels by engine power, always support front wheels in a similar manner. Loss of electrical power or transmission/hydraulic system pressure will engage the front driving wheels, pulling the rear wheels off the support if front wheels are not raised. Under these conditions, front drive wheels can engage even with switch in disengaged position.

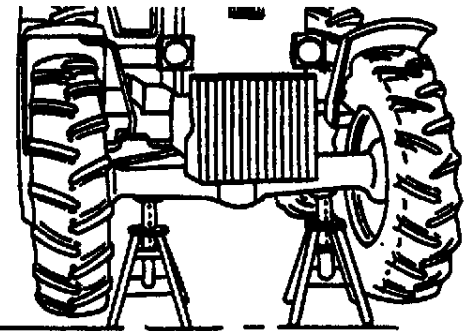

L114050

L114050-ESPDAE-140388

SERVICE HYDROSTATIC CREEPER TRANSMISSION SAFELY

Service work on the hydrostatic creeper transmission may be performed with the engine running only if front and rear wheels are raised and the tractor is safely supported.

Loss of electric power or transmission/hydraulic system pressure will engage hydrostatic creeper transmission, even if the toggle switch is in "OFF" position. Tractor could then start to move if wheels are in contact with the ground.



FXB 04001 UN

FXB04001UN, HYDRO1G 070290

PREVENT MACHINE RUNAWAY

Avoid possible injury or death from a machine runaway.

Do not start the engine by shorting across starter terminals. Machine will start in gear if normal circuitry is bypassed.

NEVER start engine while standing on ground. Start engine only from operator's seat, with the transmission in neutral or "Park".



TS177

TS177.053.BYPAS1 19 21MAY85

SERVICE MACHINE SAFELY

Tie long hair behind your head. Do not wear a necktie, scarf, loose clothing or necklace when you work near machine tools or moving parts. If these items were to get caught, severe injury could result.

Remove rings and other jewelry to prevent electrical shorts and entanglement in moving parts.

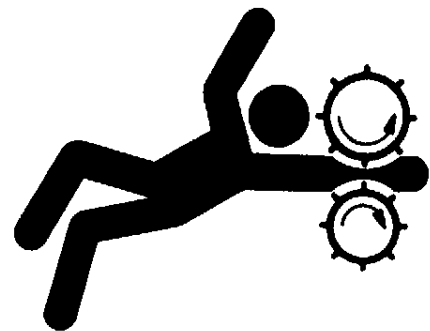

TS228

TS228.053.LOOSE 19 21DEC87

UNDERSTAND CORRECT SERVICE

Illuminate your work area adequately but safely. Use a portable safety light for working inside or under the machine. Make sure the bulb is enclosed by a wire cage. The hot filament of an accidentally broken bulb can ignite spilled fuel or oil.

Catch draining fuel, oil, or other fluids into suitable containers. Do not use food or beverage containers that may mislead someone into drinking from them. Wipe up spills at once.

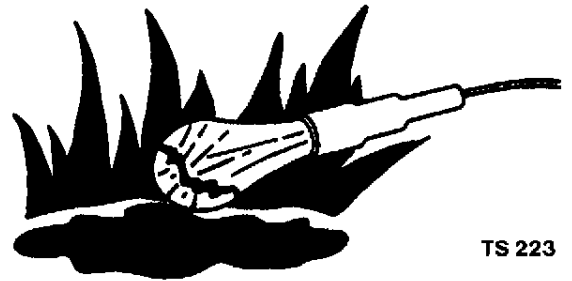

TS 223

TS223.053.LIGHT 19 23FEB88

USE TOOLS PROPERLY

Use tools appropriate to the work. Makeshift tools, parts, and procedures will not make good repairs.

Use pneumatic and electric tools only to loosen threaded parts and fasteners. Never use such tools to tighten fasteners, especially on light alloy parts.

Use only replacement parts meeting John Deere specifications.

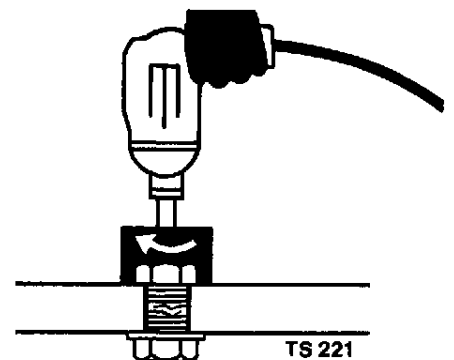

TS 221

TS221.053.REPAIR 19 21DEC87

HANDLE FLUIDS SAFELY – AVOID FIRES

When you work around fuel, do not smoke or work near heaters or other fire hazards.

Store flammable fluids away from fire hazards. Do not incinerate or puncture pressurized containers.

Make sure machine is clean of trash, grease and debris.

Do not store oily rags; they can ignite and burn spontaneously.



TS 227

TS227;053;FLAME 19 05JAN88

AVOID HIGH-PRESSURE FLUIDS

Escaping fluid (fuel or hydraulic oil) under pressure can penetrate the skin causing serious injury. Relieve pressure before disconnecting hydraulic or other lines. Tighten all connections before applying pressure. Keep hands and body away from pinholes and nozzles which eject fluids under high pressure. Use a piece of cardboard to search for leaks.

If ANY fluid is injected into the skin, it must be surgically removed within a few hours by a doctor familiar with this type of injury, or gangrene may result.

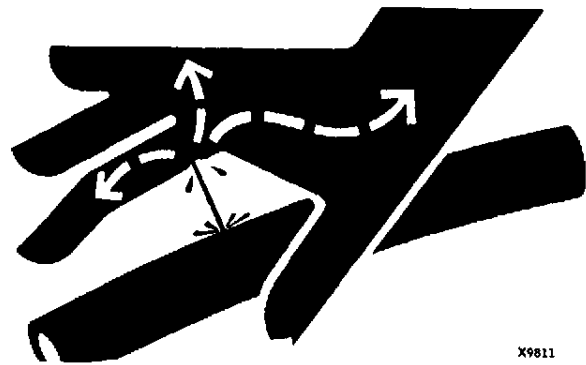

X9811

X9811;053;FLUID 19 18SEP87

REMOVE PAINT BEFORE WELDING OR HEATING

Avoid potentially toxic fumes and dust.

Hazardous fumes can be generated when paint is heated by welding, soldering or using a torch.

Do all work outside or in a well ventilated area. Dispose of paint and solvent properly.

Remove paint before welding or heating:

- If you sand or grind paint, avoid breathing the dust. Wear an approved respirator.
- If you use solvent or paint stripper, remove stripper with soap and water before welding. Remove solvent or paint stripper containers and other flammable material from area. Allow fumes to disperse at least 15 minutes before welding or heating.

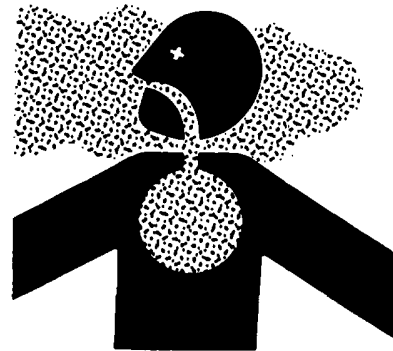

TS 220

TS220-ESPDAE-040690

AVOID HEATING NEAR PRESSURIZED FLUID LINES

Flammable spray can be generated by heating near pressurized fluid lines, resulting in severe burns to yourself and bystanders. Do not heat by welding, soldering, or using a torch near pressurized lines or other flammable materials.

Pressurized lines can be accidentally cut when heat goes beyond the immediate flame area. Install fire resisting guards to protect hoses or other materials.



TS 953

TS953-ESPDAE-040690

AVOID HARMFUL ASBESTOS DUST

Avoid breathing dust that may be generated when handling components containing asbestos fibers. Inhaled asbestos fibers may cause lung cancer.

Components in John Deere products that may contain asbestos fibers are brake pads, brake band and lining assemblies, clutch plates and some gaskets. The asbestos used in these components is usually found in a resin or sealed in some way. Normal handling is not hazardous as long as airborne dust containing asbestos is not generated.

Avoid creating dust. Never use compressed air for cleaning. Avoid brushing or grinding of asbestos-containing materials. When servicing, wear an approved respirator. A special vacuum cleaner is recommended to clean asbestos. If not available, wet the asbestos-containing materials with a mist of oil or water.

Keep bystanders away from the area.

Please note designations on spare parts.

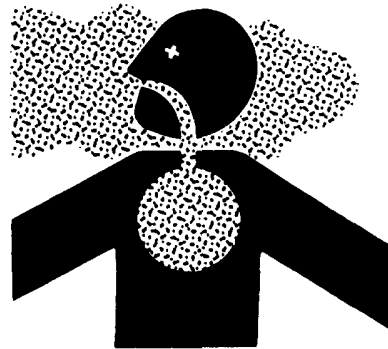

TS 220

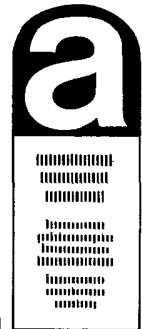

L 114 051

TS220,L114051;053;DUST 19 14APR88

PREVENT ACID BURNS

Sulfuric acid in battery electrolyte is poisonous. It is strong enough to burn skin, eat holes in clothing and cause blindness if splashed into eyes.

Avoid the hazard by:

1. Filling the batteries in a well-ventilated area.
2. Wearing eye protection and rubber gloves.
3. Avoiding breathing fumes when electrolyte is added.
4. Avoiding spilling or dripping electrolyte.
5. Use proper jump start procedure.

If you spill acid on yourself:

1. Flush your skin with water.
 2. Apply baking soda or lime to help neutralize the acid.
 3. Flush your eyes with water for 10 – 15 minutes.
- Get medical attention immediately.

If acid is swallowed:

1. Drink large amounts of water or milk.
2. Then drink milk of magnesia, beaten eggs or vegetable oil.
3. Get medical attention immediately.

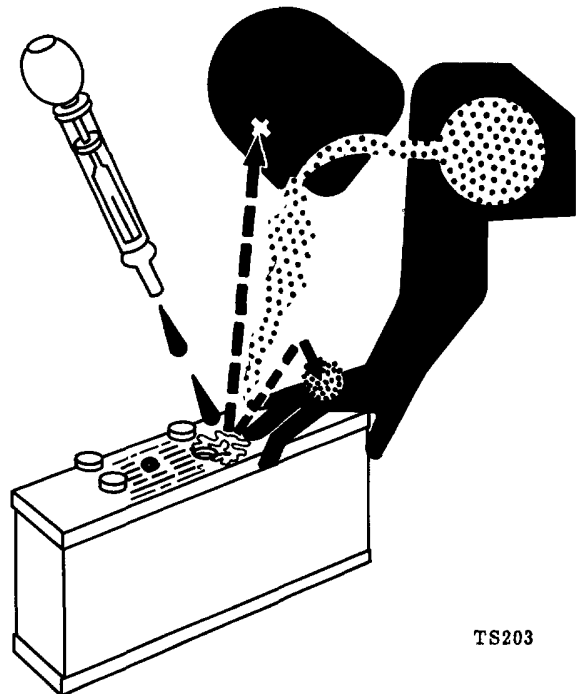

TS203

TS203;053;POISON 19 21DEC87

PREVENT BATTERY EXPLOSIONS

Keep sparks, lighted matches, and open flame away from the top of battery. Battery gas can explode.

Never check battery charge by placing a metal object across the posts. Use a volt-meter or hydrometer.

Do not charge a frozen battery; it may explode. Warm battery to 16°C (60°F).

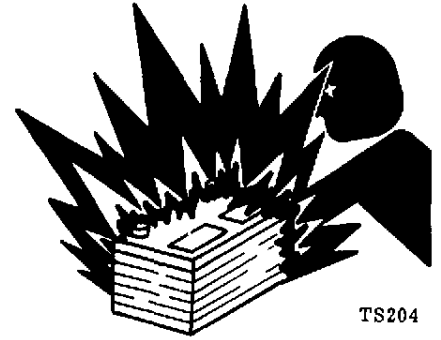

TS204

TS204;053;SPARKS 19 28JUN88

SERVICE TIRES SAFELY

Explosive separation of a tire and rim parts can cause serious injury or death.

Only attempt to mount a tire if you have the proper equipment and experience to perform the job.

Always maintain the correct tire pressure. Do not inflate tires above the recommended pressure.

When inflating tires, use a clip-on chuck and extension hose long enough to allow you to stand to one side and NOT in front of or over the tire assembly. Use a safety cage if available.

Check wheels for low pressure, cuts, bubbles, damaged rims or missing lug bolts and nuts.

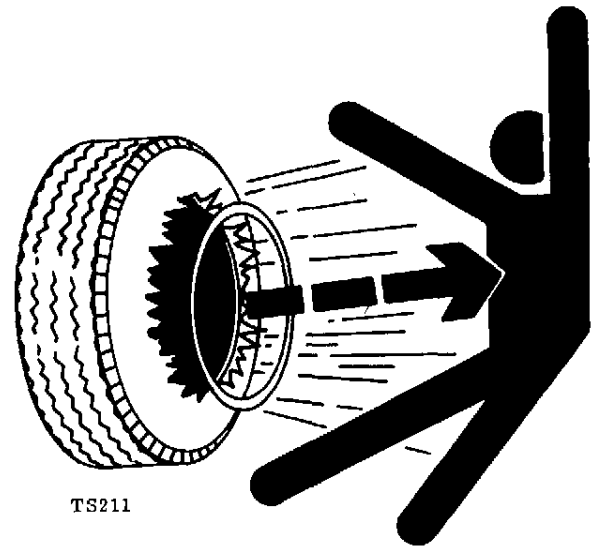

TS211

TS211;059;RIM 19 21DEC87

KEEP CAB/ROPS INSTALLED PROPERLY

Make certain all parts are reinstalled correctly if the cab or roll-over protective structure (ROPS) is loosened or removed for any reason. Tighten mounting bolts to specified torque.

Protection offered by cab or ROPS is impaired if subjected to structural damage, is involved in an overturn incident or is altered in any way by welding, bending, drilling or cutting. A damaged cab or ROPS should be replaced, not reused.

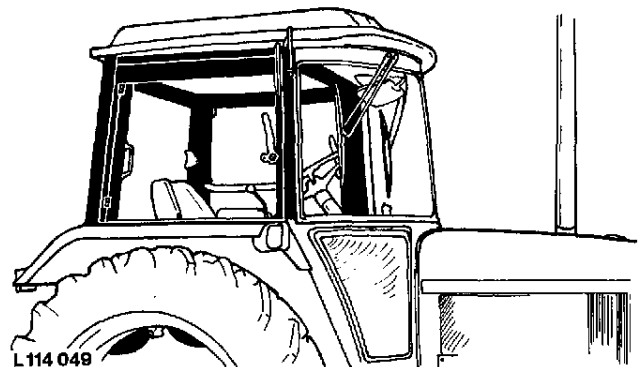

L114 048

L114049.053 ROPS 19 15MAR89

REPLACE SAFETY SIGNS

Replace missing or damaged safety signs. See the machine operator's manual for correct safety sign placement.

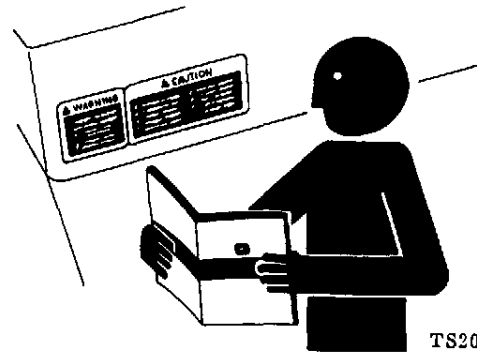

TS201

TS201,053,SIGNS1 19 22DEC87

OBSERVE ENVIRONMENTAL PROTECTION REGULATIONS

Be mindful of the environment and ecology.

Before draining any fluids, find out the correct way of disposing of them.

Observe the relevant environmental protection regulations when disposing of oil, fuel, coolant, brake fluid, filters and batteries.

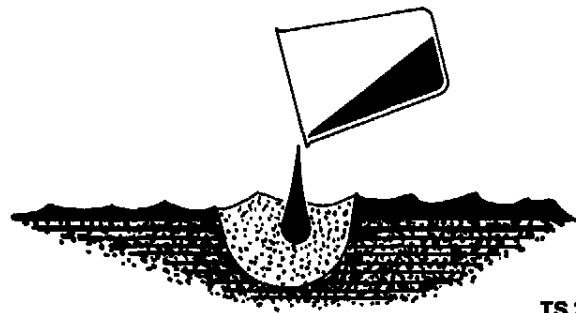

TS 222

TS222-ESPDAE-140388

Section 220 ENGINE

NOTE: The engines for these tractors are covered by Technical Manual CTM3250 for 3179, 4239 and 6359 engines.

05 – RADIATOR AND VISCOUS FAN DRIVE

Specifications	05-1
Description of radiator	05-1
Function of radiator cap:	
– Tractors with expansion tank	05-2
– Tractors without expansion tank	05-3
Diagnosing malfunctions	05-3
Testing radiator cap (tractors without expansion tank)	05-4
Checking cooling system for leaks	05-5
Function of viscous fan drive	05-6

10 – TESTS

Preliminary engine testing	10-1
Dynamometer test	10-1

	1350	1550	1750	1850	1850N	1950	1950N	2250	2450	2650	2650N	2850	3050	3350	3650
Specifications	X	X	X	X	X	X	X	X	X	X	X	X	X	X	X
Description of radiator	X	X	X	X	X	X	X	X	X	X	X	X	X	X	X
Function of radiator cap:															
– Tractors with expansion tank	X	X	X	X	X	X	X	X	X	X	X	X	X	X	X
– Tractors without expansion tank	X	X	X	X	X	X	X	X	X	X	X	X	X	X	X
Diagnosing malfunctions	X	X	X	X	X	X	X	X	X	X	X	X	X	X	X
Testing radiator cap (tractors without expansion tank)	X	X	X	X	X	X	X	X	X	X	X	X	X	X	X
Checking cooling system for leaks	X	X	X	X	X	X	X	X	X	X	X	X	X	X	X
Function of viscous fan drive	X	X	X	X	X	X	X	X	X	X	X	X	X	X	X
Preliminary engine testing	X	X	X	X	X	X	X	X	X	X	X	X	X	X	X
Dynamometer test	X	X	X	X	X	X	X	X	X	X	X	X	X	X	X

ENGINE-LB522001AE-010389

RADIATOR AND VISCOUS FAN DRIVE

SPECIFICATIONS

Tractors Without Expansion Tank

Radiator cap pressure relief valve opens at a pressure of:

- 3-cylinder tractors 40 to 50 kPa (0.4 to 0.5 bar; 6 to 7 psi)
- 4 and 6-cylinder engines 60 to 70 kPa (0.6 to 0.7 bar; 9 to 10 psi)

Tractors With Expansion Tank

Radiator cap pressure relief valve opens at a pressure of:

- 1st stage, normal operation 60 kPa (0.6 bar; 9 psi)
- 2nd stage, should a malfunction occur 120 kPa (1.2 bar; 17 psi)

On All Tractors

Cooling system test pressure 50 to 70 kPa (0.5 to 0.7 bar; 7 to 10 psi)

KUEHLER-LB522005AE-011087

DESCRIPTION OF RADIATOR

The engine radiator is of the conventional design with cooling tubes through which the coolant passes and soldered exterior fins.

The coolant in the cooling tubes is cooled by air (B) forced through the radiator core by the fan blades. Cooling surface of tubes is greatly increased by means of fins (C).

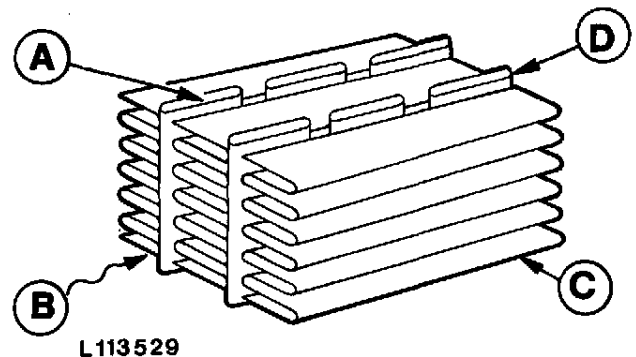

A-Coolant passage
B-Air

C-Fin
D-Tube

L113529-LA722005AE-020188

**FUNCTION OF RADIATOR CAP
(Tractors With Expansion Tank)**

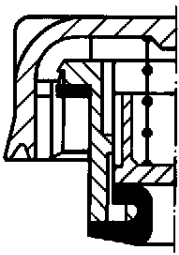
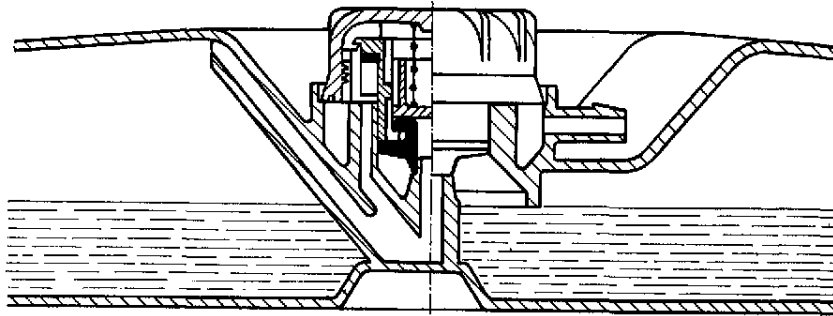

A

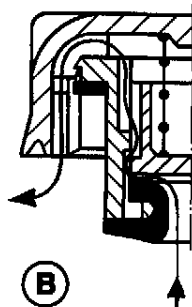

B

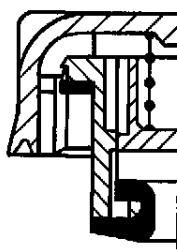

C

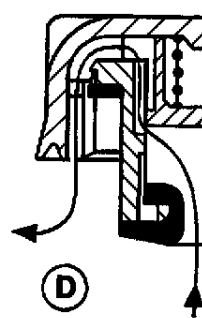

D

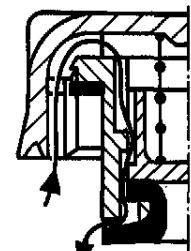

E

L 118 404 A

A—Pressure below 60 kPa (0.6 bar; 9 psi); pressure relief valve closed
B—Pressure between 60 kPa (0.6 bar; 9 psi) and 80 kPa (0.8 bar; 12 psi); pressure relief valve open

C—Pressure between 80 kPa (0.8 bar; 12 psi) and 120 kPa (1.2 bar; 17 psi); pressure relief valve closed

D—Pressure above 120 kPa (1.2 bar; 17 psi); pressure relief valve open
E—Pressure below 2 kPa (0.2 bar; 0.3 psi); vacuum valve open

Under normal operating conditions, there should be a build-up of pressure in the cooling system (see "A").

To prevent pressure becoming too high, pressure relief valve opens at a specified pressure (see "B").

This pressurized cooling system permits the engine to be operated at high temperatures without coolant boiling or loss of coolant due to evaporation. Higher operating temperatures are desirable for efficient combustion and for evaporating contaminants from the crankcase.

Should the engine become particularly warm, for example if the engine is shut off after operating under heavy load, the pressure relief valve closes and allows a higher pressure build-up and no loss of coolant (see "C").

Should pressure build-up continue (malfunction in system), pressure relief valve will open at a specified pressure in order to prevent damage due to excess pressure (see "D").

To prevent build-up of a vacuum which could occur in the system when the coolant cools, the vacuum valve opens (see "E").

L118404A-LB522005AE-010389

FUNCTION OF RADIATOR CAP (Tractors Without Expansion Tank)

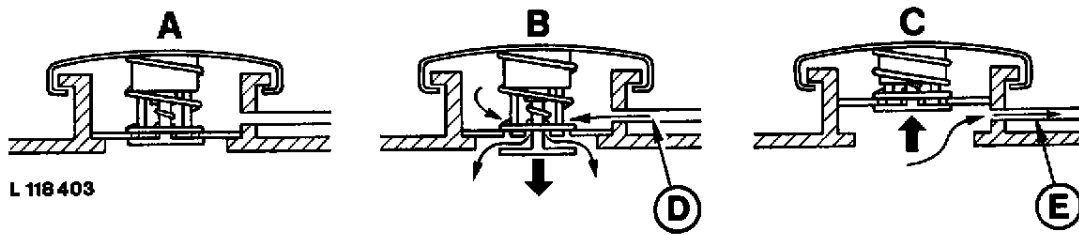

L 118 403

A-Valve closed
B-Vacuum valve open

C-Pressure relief valve open

D-Air
E-Overflow tube

The radiator filler neck has a bayonet-fitting cap which has a pressure relief valve and a vacuum valve. The pressure relief valve (C) in the cap permits the escape of coolant or steam when the pressure reaches a certain level. Vacuum valve (B) in the cap opens at a certain underpressure, thus preventing the build-up of a vacuum in the cooling system.

The pressure cooling system permits the engine to be operated at high temperatures without boiling the coolant or losing it by evaporation. Higher operating temperatures are desirable for efficient combustion and for evaporating contaminants from the crankcase.

L 118403-LB522005AE-011087

DIAGNOSING MALFUNCTIONS

ENGINE OVERHEATS

- Slack fan belt
- Dirty radiator or grille screens
- Low coolant level
- Low engine oil level
- Improper operation
- Defective cylinder head gasket
- Fuel injection pump incorrectly timed
- Defective thermostat(s)
- Defective radiator cap
- Defective water pump
- Corrode coolant passages

LOW COOLANT LEVEL

- Improper maintenance
- Improper operation
- Damaged radiator
- Water pump seal leakage
- Leakage
- Defective radiator cap

KUEHLER-LA722005AE-000186

**TESTING RADIATOR CAP
(Tractors Without Expansion Tank)**

Remove radiator cap and test with a commercial radiator and pressure cap tester.

Pressure relief valve in radiator cap should open at the following pressures:

- 3-cylinder engines 40 to 50 kPa
(0.4 to 0.5 bar; 6 to 7 psi)
- 4 and 6-cylinder engines 60 to 70 kPa
(0.6 to 0.7 bar; 9 to 10 psi)

Check radiator cap rubber sealing ring for cracks and brittleness. The bevelled sealing ring must be soft and seated securely.

Check spring.

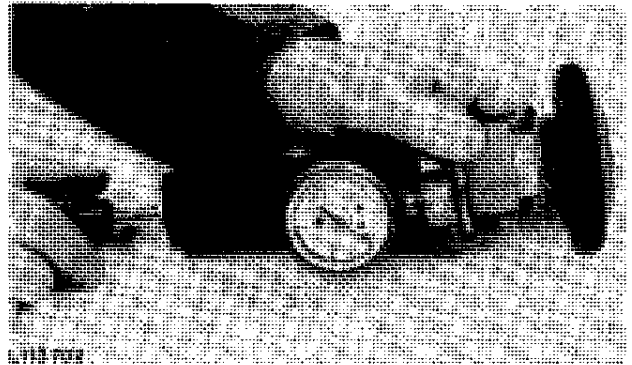

L113702-LB522005AE-001087

CHECKING COOLING SYSTEM FOR LEAKS

Check radiator, hoses, water pump and engine for leaks, and repair when necessary.

Check exterior of radiator for damage or bent fins.

NOTE: Radiator repairs should be carried out only by experienced mechanics or in specialist repair workshops.

Carefully clean radiator exterior and straighten any bent fins.

Connect commercial radiator tester to the filler neck (tractors without expansion tank) or engine block drain tap (tractors with expansion tank).

Apply a pressure of 50 to 70 kPa (0.5 to 0.7 bar; 7 to 10 psi) to the cooling system.

If radiator leaks and source of leak cannot be determined visually, then proceed as follows:

Remove radiator (see relevant T.M. "Repair").

Install radiator cap and plug top hose connection.

Attach compressed air hose to bottom radiator inlet.

Immerse radiator in tank filled with clear water.

By means of attached air hose, carefully place radiator under test pressure of 50 to 70 kPa (0.5 to 0.7 bar; 7 to 10 psi).

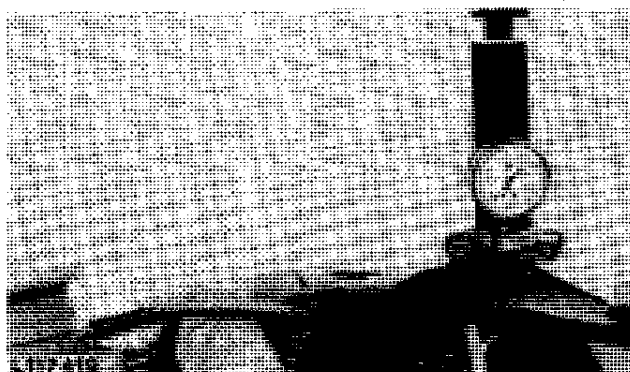

FUNCTION OF VISCOUS FAN DRIVE

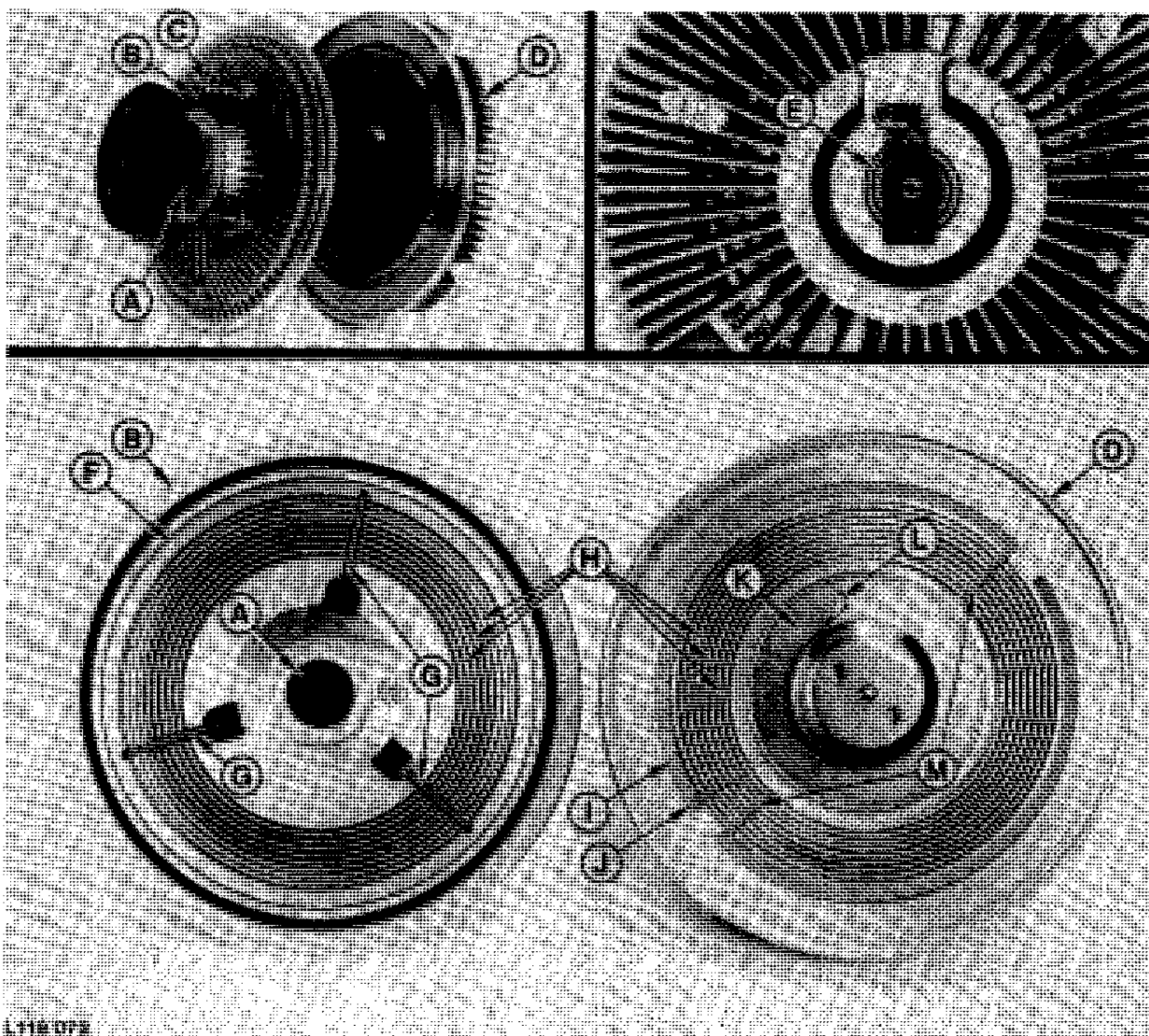

A-Drive shaft
 B-Fan carrier
 C-Studs for attaching fan (4 used)
 D-Driven clutch half

E-Bimetallic coiled spring
 F-Driving clutch half
 G-Grooves
 H-Channels (operating chamber)

I-Groove
 J-Return channel
 K-Reservoir
 L-Reservoir cap
 M-Grooves

L119072-LB522005AE-001087

Radiator and Viscous Fan Drive

The viscous fan drive consists of driving clutch half (F) with drive shaft (A), driven clutch half (D) with reservoir (K) and fan carrier (B). The fan carrier is seated with bearings on drive shaft. The channels (H) of both clutch halves form the operating chamber. The system is filled with a silicone fluid.

Torque is transmitted by means of the inner friction between the fluid and the surface of the operating chamber. The operating chamber surface is enlarged by means of grooves.

The amount of silicone fluid in viscous fan drive exceeds capacity of the reservoir so that there is always some fluid in the operating chamber. Consequently, driven clutch half (D) turns even when the radiator is cold, but at a slower speed than the driving clutch half.

As the radiator gets warm, bimetallic spring (E) expands and opens reservoir cap (L). Centrifugal force causes fluid to flow from the reservoir into the operating chamber. The high friction of the fluid in the operating chamber causes the speed of the driven clutch half to increase until both halves are travelling at the same speed.

Centrifugal force causes oil to be forced outwards through groove (I) and, due to rotational speed, to be carried via return channel (J) to the reservoir. A cycle takes place, fluid being constantly forced back into the reservoir and at the same time flowing into the operating chamber.

Because of the high fan speed, radiator temperature sinks. The bimetallic spring coil contracts, closing the reservoir cap and preventing further silicone fluid from flowing to the operating chamber. Fluid continues to flow into reservoir through groove (I). The amount of fluid in the operating chamber decreases, reducing friction and fan speed slows.

Grooves (G and M) enable fluid to flow quicker into the operating chamber, enabling the viscous fan drive to react more quickly to changes in the radiator temperature.

KUEHLER-LB522005AE-001087

PRELIMINARY ENGINE TESTING

Before tuning a tractor engine, determine whether a tune-up will restore operating efficiency. When there is doubt, the following preliminary tests will help to determine whether the engine can be tuned up. Perform the following tests:

After engine has been stopped for several hours, carefully loosen crankcase drain plug and watch for any water to seep out. A few drops could be due to condensation, but any more than this would indicate problems which require engine repairs rather than just a tune-up.

With engine stopped, inspect engine coolant for an oil film. With engine running, inspect coolant for air bubbles. Either condition would indicate problems which require engine repairs rather than just a tune-up.

Perform a dynamometer test as instructed below. Repeat dynamometer test after tune-up so that horsepower before and after tune-up can be compared.

Measure compression as described in the Technical Manual for 3179, 4239 and 6359 engines.

PRUEFMOT-LB522010AE-011087

DYNAMOMETER TEST

If possible, test the engine on a dynamometer before it is tuned.

This test indicates whether a tune-up can restore the engine or whether an overhaul is needed.

Good engine performance depends to a great extent on the following:

- An adequate supply of clean air and fuel
- Good compression
- Proper valve and injection pump timing for good combustion
- Proper air and fuel temperatures

PRUEFMOT-LA722010BE-020186

Tests

Perform dynamometer test as follows:

– Connect dynamometer to tractor PTO as described in the manufacturer's instructions.

– Run engine at half load until coolant and engine oil have reached normal operating temperature.

– Run engine at fast idle speed*.

– Gradually increase engine load until engine speed sinks to rated speed*.

– Read the horsepower on dynamometer.

Compare reading with relevant PTO* specifications.

* See relevant T.M. "Repair" for engine speeds and specifications.

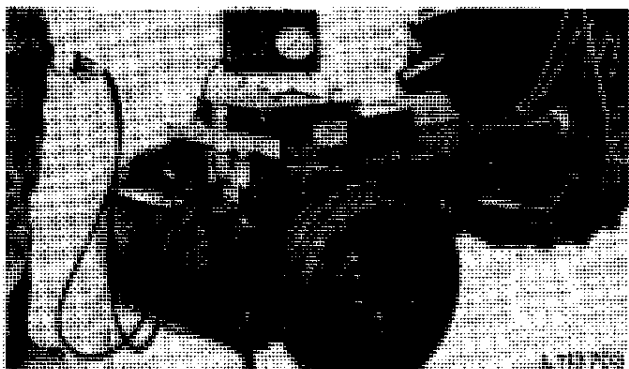

L113703-LB522010AE-011087

Section 230

FUEL AND AIR INTAKE SYSTEM

NOTE: The fuel transfer pump, fuel filter, fuel injection pump, fuel injection nozzles and turbocharger (when equipped) are dealt with in Technical Manual – Engines 3179, 4239 and 6359.

05 – FUEL TANK, AUXILIARY FUEL TANK AND WATER TRAP

Description	
– Fuel tank and auxiliary fuel tank	05-1
– Water trap	05-2

10 – COLD WEATHER STARTING AIDS

Function of ether starting fluid aid	10-1
Function of electric starting aid	10-2
Function of fuel pre-heater	10-3

15 – SPEED CONTROL LINKAGE

Description	15-1
-------------------	------

20 – AIR CLEANER

Special tools	20-1
Function of air cleaner	20-1
Checking air intake system	20-2

	1350	1550	1750	1850	1850N	1950	1950N	2250	2450	2650	2650N	2850	3050	3350	3650
05 – FUEL TANK, AUXILIARY FUEL TANK AND WATER TRAP															
– Fuel tank and auxiliary fuel tank	x	x	x	x	x	x	x	x	x	x	x	x	x	x	x
– Water trap	x	x	x	x	x	x	x	x	x	x	x	x	x	x	x
10 – COLD WEATHER STARTING AIDS															
Function of ether starting fluid aid	x	x	x	x	x	x	x	x	x	x	x	x	x	x	x
Function of electric starting aid	x	x	x	x	x	x	x	x	x	x	x	x	x	x	x
Function of fuel pre-heater	x	x	x	x	x	x	x	x	x	x	x	x	x	x	x
15 – SPEED CONTROL LINKAGE															
Description	x	x	x	x	x	x	x	x	x	x	x	x	x	x	x
20 – AIR CLEANER															
Special tools	x	x	x	x	x	x	x	x	x	x	x	x	x	x	x
Function of air cleaner	x	x	x	x	x	x	x	x	x	x	x	x	x	x	x
Checking air intake system	x	x	x	x	x	x	x	x	x	x	x	x	x	x	x

KRAFTSTOFF-LB523001AE-010389

FUEL TANK, AUXILIARY FUEL TANK UND WATER TRAP

DESCRIPTION

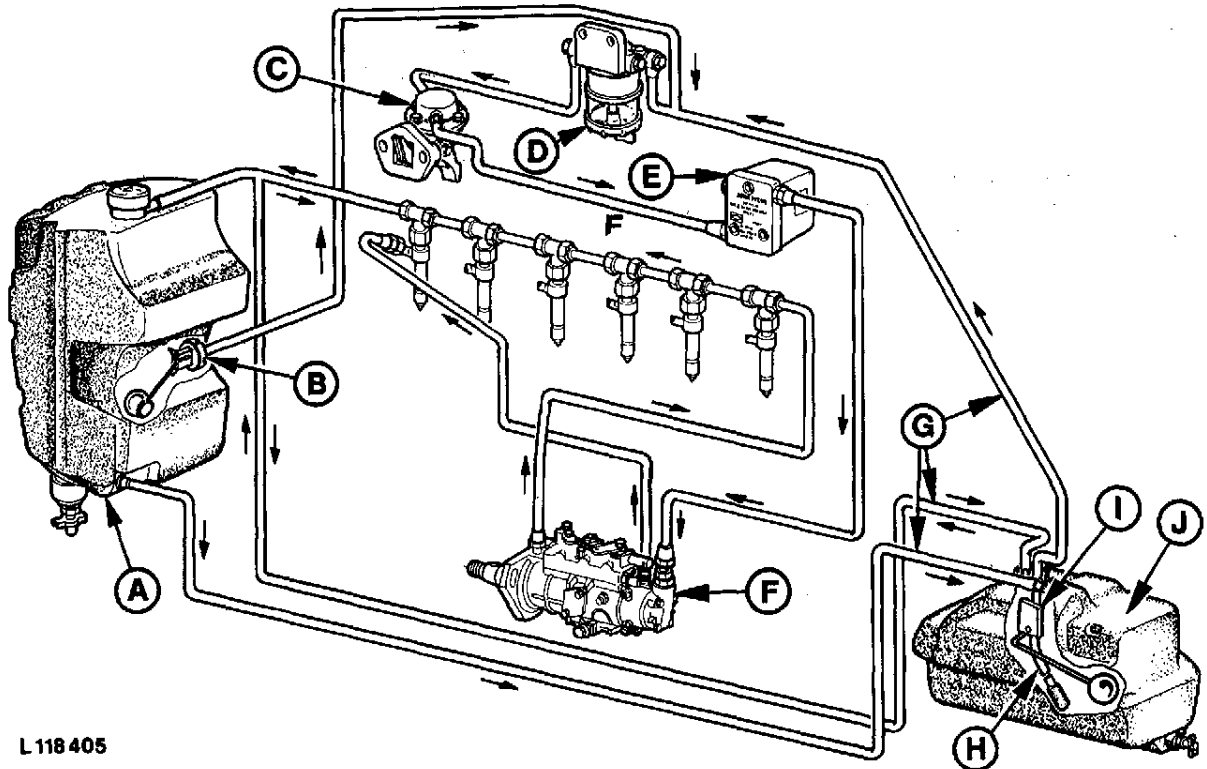

L 118 405

A-Fuel tank
 B-Fuel gauge sending unit
 (fuel tank)
 C-Fuel transfer pump
 D-Water trap

E-Fuel filter
 F-Fuel injection pump
 G-Fuel lines for auxiliary
 fuel tank*

H-Suction line for
 auxiliary fuel tank*
 I-Fuel gauge sending unit
 (auxiliary fuel tank)*
 J-Auxiliary fuel tank*

* When equipped

Fuel Tank and Auxiliary Fuel Tank

The fuel tank system consists of the main fuel tank (A) and an auxiliary fuel tank (J). The fuel is filled into fuel tank (A) and runs into the auxiliary fuel tank (J) mounted below it.

The two tanks are connected by an inlet line and a bleed line.

The fuel is drawn from auxiliary fuel tank (J) via suction line (H) and fed to the fuel injection pump (F).

The two fuel gauge sending units (B and I) are connected in series, thus ensuring that the fuel gauge always shows the correct fuel quantity.

If the complete fuel system is to be drained, drain fuel through the auxiliary fuel tank.

L118405-LB523005AE-011087

Water Trap

The water trap is located between fuel tank system and fuel transfer pump, and filters water and sediment deposits from the fuel.

Due to their greater specific density, water and sediment deposits are heavier than fuel and are therefore deposited in the lower cover. To drain water and sediment deposits from water trap, loosen drain plug (A).

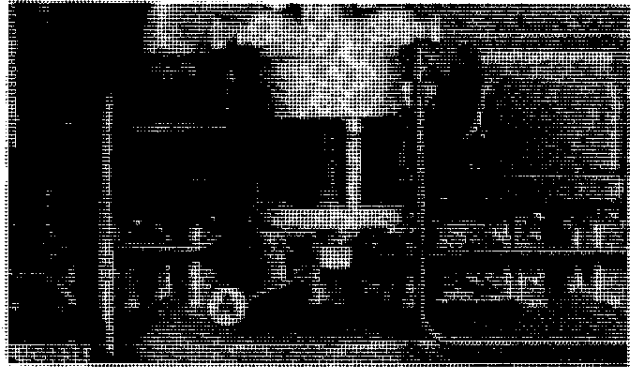

L106634-LA723005AE-000186

FUNCTION OF ETHER STARTING FLUID AID

Since the engine depends on heat in the combustion chamber to ignite the fuel, starting the engine in cold weather may be a problem. Since the starting fluid (ether) has a low ignition point, heat generated in the combustion chamber during compression is able to ignite it.

Heat from this ignition then ignites the fuel/air mixture and normal combustion takes place.



CAUTION: Ether starting fluid is highly flammable.

STAID-LB523010AE-001087

Electric Ether Starting Aid

The ether pressure can (G) is operated via a solenoid switch (D). Pushing the push-button switch opens valve on pressure can, thereby ether flows into inlet manifold.

IMPORTANT: Turn engine with starter one or two revolutions before injecting starting fluid. Inject starting fluid at brief intervals only while engine is turning.

IMPORTANT: Ensure that fluid can is always attached to adapter to prevent dust and dirt from being drawn into engine.

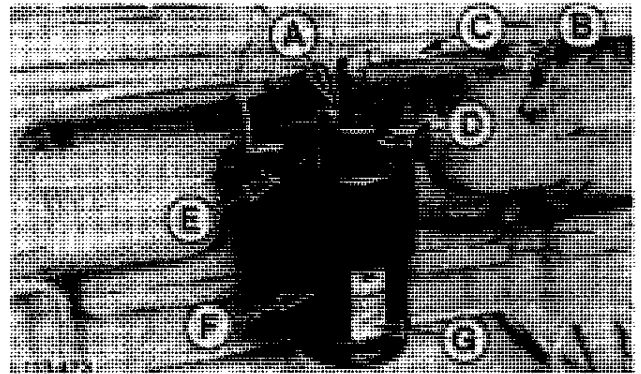

- | | |
|-------------------|--|
| A-Connector | E-Cap screw (2 used) |
| B-Nozzle holder | F-Pressure can holder |
| C-Pressure line | G-Pressure can with ether starting fluid |
| D-Solenoid switch | |

L113473-LB523010AE-011087

Manual Ether Starting Aid

To use the starting aid, valve of pressure can (A) is opened by pushing up on can for a short period against can connection. Thereby ether fluid flows into intake manifold.

IMPORTANT: Turn engine with starter one or two revolutions before injecting starting fluid. Inject starting fluid at brief intervals only while engine is turning.



L118.406

L118406-LB523010AE-011087

FUNCTION OF ELECTRIC STARTING AID

Since the engine depends on the heat in the combustion chamber to ignite the fuel, starting the engine in cold weather may be a problem.

The air drawn into the engine is heated by glow plug (A) and improves starting in cold weather.

The glow plug is installed in air intake manifold. By turning starter switch (D) clockwise to first position electrical circuit is closed.

- A-Glow plug
- B-Relay
- C-Alternator
- D-Starter switch

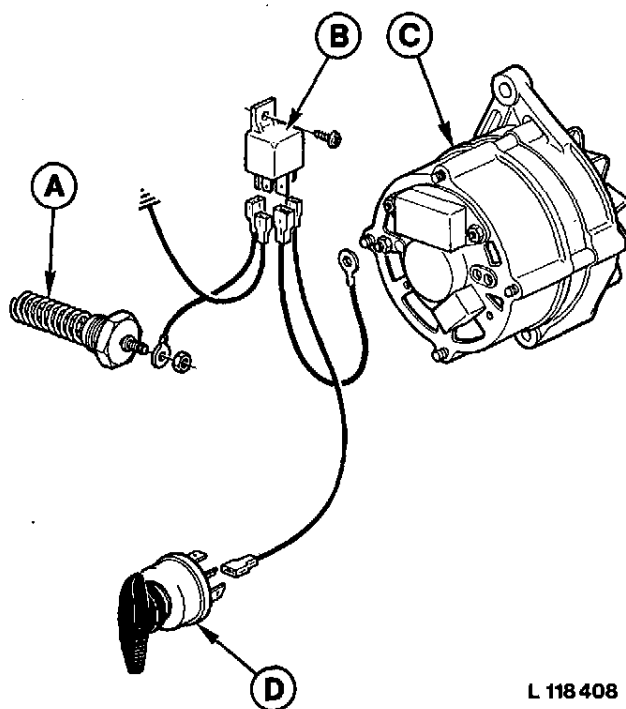

L 118 408

L118408-LB523010AE-001067

FUNCTION OF FUEL PREHEATER

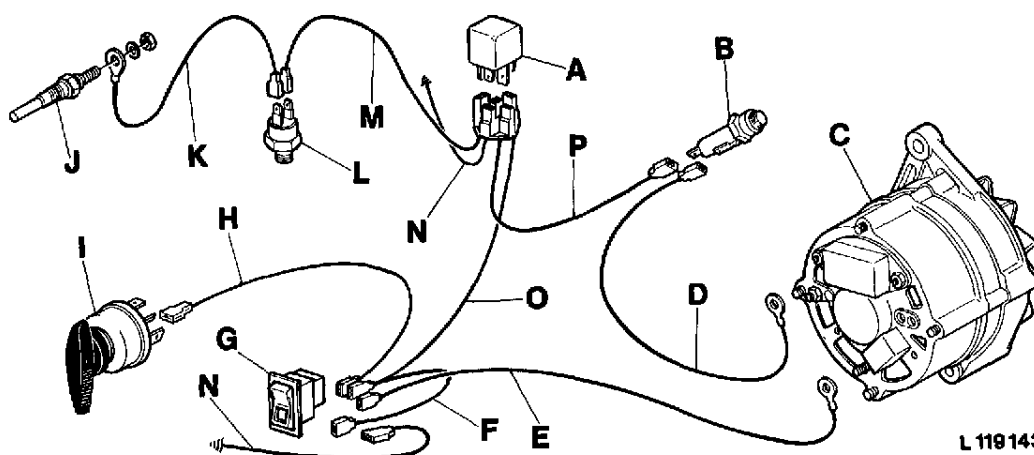

- | | | | |
|--|--|--|-------------------------------------|
| A-Relay | F-Wire jumper | K-Cable from thermal switch to glow plug | N-Ground cable |
| B-Fuse holder | G-Toggle switch | L-Thermal switch | O-Cable from toggle switch to relay |
| C-Alternator | H-Cable from starter switch to toggle switch | M-Cable from relay to thermal switch | P-Cable from fuse holder to relay |
| D-Cable from alternator to fuse holder | I-Starter switch | | |
| E-Cable from alternator to toggle switch | J-Glow plug | | |

The fuel preheater is operated by means of toggle switch (G). Glow plug (J) is switched off automatically by means of thermal switch (L) if fuel preheater is switched on for too long with engine stationary.

The glow plug and thermal switch are integrated into the fuel filter plate.

L119143-LB523010AE-010389

Group 15 SPEED CONTROL LINKAGE

DESCRIPTION

The desired engine speed is selected by means of the hand throttle (A) or foot throttle (D). The position of these levers controls – through the governor on the fuel injection pump – the amount of fuel being injected into the cylinders.

The hand throttle is self-locking: Two spring-loaded friction disks (B) hold the lever in the position selected.

With engine running at slow idle speed, hand throttle lever (A) lies against stop screw (C).

If hand throttle lever is pushed forward until speed control lever lies against forward stop on pump, the engine runs at fast idle speed.

The engine is stopped by means of a shut-off cable. One end of this cable is connected to the fuel injection pump lever, the other to a knob in the dash.

A–Hand throttle
B–Friction disks

C–Stop screw
D–Foot throttle

NOTE: The illustration shows speed control linkage of a tractor equipped with SG2 cab.

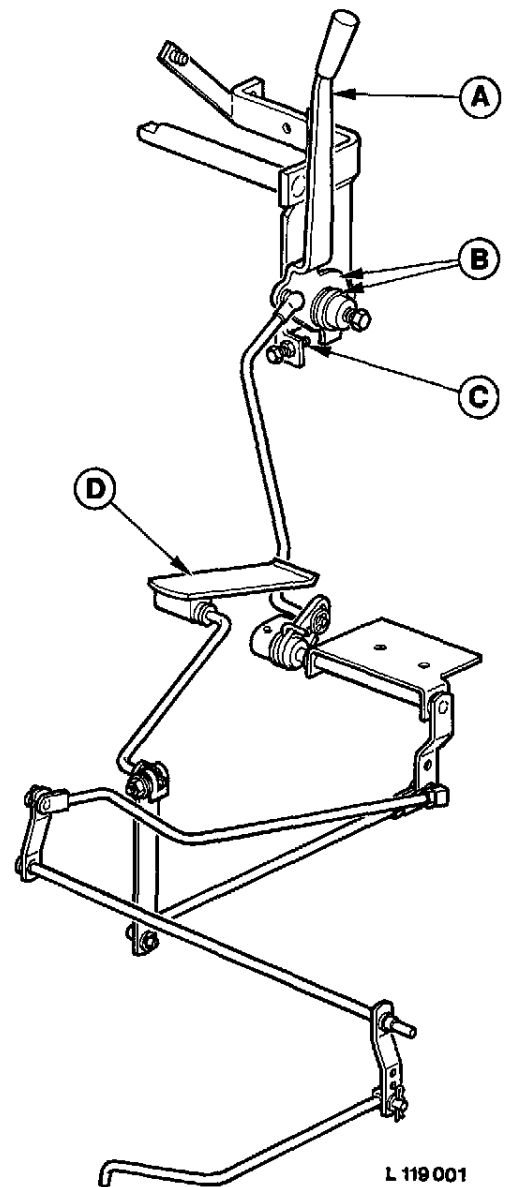

L119001-LB523015AE-011087

SPECIAL TOOLS

FKM10242

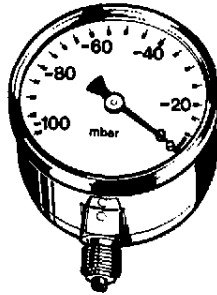

(A)

FKM10002

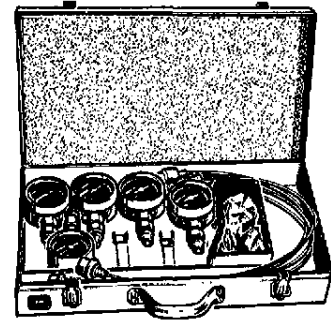

(B)

L 119 002

A,B—Measuring air intake
system vacuum

L119002-LB523020AE-011087

FUNCTION OF THE AIR CLEANER

Under the influence of suction generated by the engine, unfiltered air flows through air inlet tube (A) and is forced into a high-speed centrifugal motion by tilted fin insert. By this circulating action, most of the dirt and dust particles are separated from the air and collected in the dust unloading valve (C).

The remaining dirt is removed as the air flows through primary element (D) and secondary (safety) filter (B) before being drawn into the engine.

- A—Air inlet
- B—Secondary (safety) element
- C—Dust unloading valve
- D—Primary element
- E—Air outlet

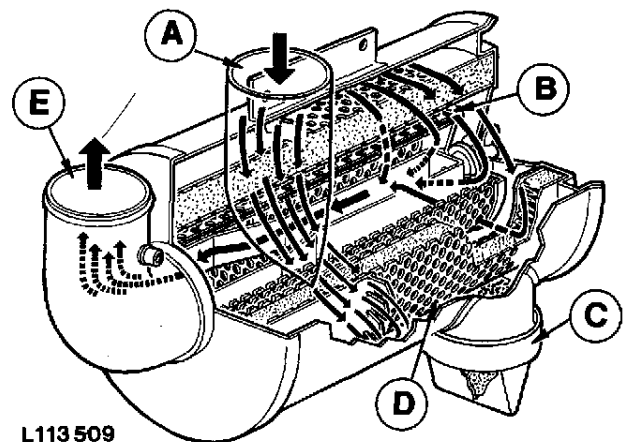

L113 509

L113509-LB523020AE-011087

FUNCTION OF THE AIR CLEANER (CONTD.)

The secondary (safety) filter (B) ensures that should primary element (D) fail, no unfiltered air is drawn into the engine.

A restriction warning switch in conjunction with an air cleaner indicator light located in the dash indicates when air cleaner element requires cleaning (see Operator's Manual).

Should the restriction warning switch appear to be faulty, check air intake system as follows. Carry out this check also after adjustment or reconditioning of the engine.

LUFFILTER-LA723020AE-020186

CHECKING AIR INTAKE SYSTEM

Clean air cleaner.

Remove air pre-cleaner (when equipped).

Depending on tractor equipment, remove glow plug of electric starting aid or adapter of ether starting aid or plug in intake manifold.
Connect vacuum gauge.

Run engine until it reaches operating temperature.

Run engine at fast idle speed.

With a clean element installed, vacuum shown on gauge should be approx. 3.5 kPa (35 mbar; 14 in. water head), but should never exceed 6 kPa (60 mbar; 25 in. water head).

If this is the case, there is a restriction in the air intake system. Determine and remedy the cause.

A-Vacuum gauge FKM10242
B-Connector FKM10303*
C-Male connector JT05495*
D-Pressure hose FKM10209*
E-Connector FKM10302*

* Part of testing kit FKM10002

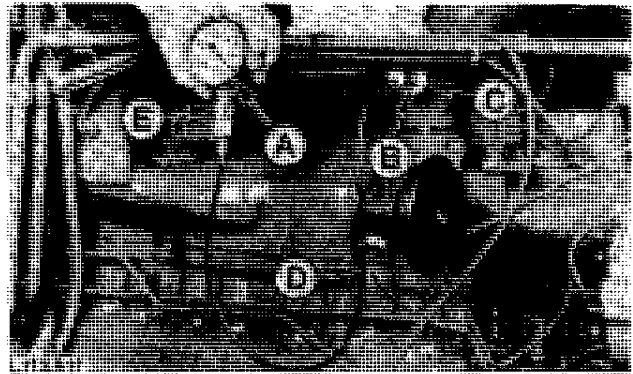

L113511-LB523020AE-011087

Air Cleaner

At the same time, check air cleaner restriction warning switch (A).

Run engine at rated engine speed and partially cover the air cleaner intake with a piece of cardboard. Increase restriction until air cleaner restriction indicator light goes on, then read vacuum gauge reading.

Air cleaner restriction warning switch should close at a vacuum of 5.5 to 6.5 kPa (55 to 65 mbar; 22 to 26 in. water head). If not, replace switch.

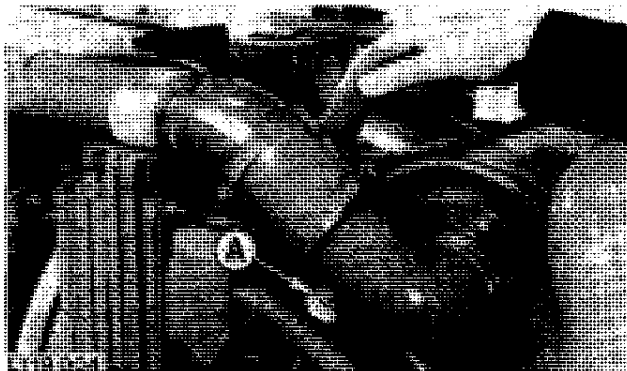

L119004-LB523020AE-011087

Electrical Equipment

15 - CIRCUIT DIAGNOSIS (Without Cab)

	1350	1550	1750	1850	1850N	1950	1950N	2250	2450	2650	2650N	2850	3050	3350	3650
Special tools	15-1	x	x	x	x	x	x	x	x	x	x	x	x	x	x
Starting motor and charging circuit															
S1-Electrical circuit diagram	15-2	x	x	x	x	x	x	x	x	x	x	x	x	x	x
S1-Current circuit	15-3	x	x	x	x	x	x	x	x	x	x	x	x	x	x
S1A-Electrical circuit diagram	15-4	x	x	x	x	x	x	x	x	x	x	x	x	x	x
S1A-Current circuit	15-5	x	x	x	x	x	x	x	x	x	x	x	x	x	x
Cold weather starting aids															
S2-Electrical circuit diagram	15-6	x	x	x	x	x	x	x	x	x	x	x	x	x	x
S2-Current circuit	15-7	x	x	x	x	x	x	x	x	x	x	x	x	x	x
Fuel preheater															
S3-Electrical circuit diagram	15-8	x	x	x	x	x	x	x	x	x	x	x	x	x	x
S3-Current circuit	15-9	x	x	x	x	x	x	x	x	x	x	x	x	x	x
Hazard warning and turn signal lights															
S4-Electrical circuit diagram	15-10	x	x	x	x	x	x	x	x	x	x	x	x	x	x
S4-Current circuit	15-11	x	x	x	x	x	x	x	x	x	x	x	x	x	x
Stop lights															
S5-Electrical circuit diagram	15-12	x	x	x	x	x	x	x	x	x	x	x	x	x	x
S5-Current circuit	15-13	x	x	x	x	x	x	x	x	x	x	x	x	x	x
Signal horn and hazard warning lights system															
S6-Electrical circuit diagram	15-14	x	x	x	x	x	x	x	x	x	x	x	x	x	x
S6-Current circuit	15-15	x	x	x	x	x	x	x	x	x	x	x	x	x	x
Socket															
S7-Electrical circuit diagram	15-16	x	x	x	x	x	x	x	x	x	x	x	x	x	x
S7-Current circuit	15-17	x	x	x	x	x	x	x	x	x	x	x	x	x	x
Instrument cluster and front-wheel drive															
S8-Electrical circuit diagram	15-18	x	x	x	x	x	x	x	x	x	x	x	x	x	x
S8-Current circuit	15-19	x	x	x	x	x	x	x	x	x	x	x	x	x	x
Front PTO															
S9-Electrical circuit diagram	15-20	x	x	x	x	x	x	x	x	x	x	x	x	x	x
S9-Current circuit	15-21	x	x	x	x	x	x	x	x	x	x	x	x	x	x
Right-hand tail light and 7-terminal socket															
S10-Electrical circuit diagram	15-22	x	x	x	x	x	x	x	x	x	x	x	x	x	x
S10-Current circuit	15-23	x	x	x	x	x	x	x	x	x	x	x	x	x	x
Registration plate light, instrument lighting, right-hand clearance light and left-hand tail light															
S11-Electrical circuit diagram	15-24	x	x	x	x	x	x	x	x	x	x	x	x	x	x
S11-Current circuit	15-25	x	x	x	x	x	x	x	x	x	x	x	x	x	x
Parking lights, left-hand clearance light, 7-terminal socket and worklights															
S12-Electrical circuit diagram	15-26	x	x	x	x	x	x	x	x	x	x	x	x	x	x
S12-Current circuit	15-27	x	x	x	x	x	x	x	x	x	x	x	x	x	x
High and low beam headlights															
S13-Electrical circuit diagram	15-28	x	x	x	x	x	x	x	x	x	x	x	x	x	x
S13-Current circuit	15-29	x	x	x	x	x	x	x	x	x	x	x	x	x	x

ELEKTR-LB524002AE-010388

20 – SEALED BEAM LIGHTING SYSTEM

For details of the "Sealed Beam" system, refer to Technical Manual CTM-4459 20-1

25 – ELECTRICAL DIAGRAMS (With MC1 Cab)

Parts designations in electrical circuit and wiring diagrams 25-1
 Section designations in circuit diagrams 25-3
 Harness designations in wiring diagrams 25-3
 Electrical circuit diagram (complete tractor) 25-5
 Engine wiring harnesses 25-8
 Wiring diagram – Engine 25-9
 Dash panel wiring harnesses 25-10
 Wiring diagram – Dash panel 25-11
 Transmission wiring harness 25-12
 Wiring harnesses – MC1 cab 25-13
 Wiring diagram – Cab and transmission 25-15
 Hydrostatic creeper wiring harness 25-16
 Wiring diagram – hydrostatic creeper 25-17
 Printed circuit board and pin assignment of instrument cluster 25-18

30 – CIRCUIT DIAGNOSIS (With MC1 Cab)

Special tools 30-1
 Starting motor and charging circuit
 S1-Electrical circuit diagram 30-2
 S1-Current circuit 30-3
 Cold weather starting aids
 S2-Electrical circuit diagram 30-4
 S2-Current circuit 30-5
 Fuel preheater
 S3-Electrical circuit diagram 30-6
 S3-Current circuit 30-7
 Hazard warning and turn signal lights
 S4-Electrical circuit diagram 30-8
 S4-Current circuit 30-9
 Radio and cab interior light
 S5-Electrical circuit diagram 30-10
 S5-Current circuit 30-11
 Stop lights
 S6-Electrical circuit diagram 30-12
 S6-Current circuit 30-13

	1350	1550	1750	1850	1850N	1950	1950N	2250	2450	2650	2650N	2850	3050	3350	3650
For details of the "Sealed Beam" system, refer to Technical Manual CTM-4459 20-1		X	X	X	X	X	X	X	X	X	X	X	X	X	
Parts designations in electrical circuit and wiring diagrams 25-1		X	X	X		X		X	X	X		X			
Section designations in circuit diagrams 25-3		X	X	X		X		X	X	X		X			
Harness designations in wiring diagrams 25-3		X	X	X		X		X	X	X		X			
Electrical circuit diagram (complete tractor) 25-5		X	X	X		X		X	X	X		X			
Engine wiring harnesses 25-8		X	X	X		X		X	X	X		X			
Wiring diagram – Engine 25-9		X	X	X		X		X	X	X		X			
Dash panel wiring harnesses 25-10		X	X	X		X		X	X	X		X			
Wiring diagram – Dash panel 25-11		X	X	X		X		X	X	X		X			
Transmission wiring harness 25-12		X	X	X		X		X	X	X		X			
Wiring harnesses – MC1 cab 25-13		X	X	X		X		X	X	X		X			
Wiring diagram – Cab and transmission 25-15		X	X	X		X		X	X	X		X			
Hydrostatic creeper wiring harness 25-16		X	X	X		X		X	X	X		X			
Wiring diagram – hydrostatic creeper 25-17		X	X	X		X		X	X	X		X			
Printed circuit board and pin assignment of instrument cluster 25-18		X	X	X		X		X	X	X		X			
Special tools 30-1		X	X	X		X		X	X	X		X			
Starting motor and charging circuit															
S1-Electrical circuit diagram 30-2		X	X	X		X		X	X	X		X			
S1-Current circuit 30-3		X	X	X		X		X	X	X		X			
Cold weather starting aids															
S2-Electrical circuit diagram 30-4		X	X	X		X		X	X	X		X			
S2-Current circuit 30-5		X	X	X		X		X	X	X		X			
Fuel preheater															
S3-Electrical circuit diagram 30-6		X	X	X		X		X	X	X		X			
S3-Current circuit 30-7		X	X	X		X		X	X	X		X			
Hazard warning and turn signal lights															
S4-Electrical circuit diagram 30-8		X	X	X		X		X	X	X		X			
S4-Current circuit 30-9		X	X	X		X		X	X	X		X			
Radio and cab interior light															
S5-Electrical circuit diagram 30-10		X	X	X		X		X	X	X		X			
S5-Current circuit 30-11		X	X	X		X		X	X	X		X			
Stop lights															
S6-Electrical circuit diagram 30-12		X	X	X		X		X	X	X		X			
S6-Current circuit 30-13		X	X	X		X		X	X	X		X			

ELEKTR-LB524003AE-010389

30 - CIRCUIT DIAGNOSIS (With MC1 Cab) - CONTD.

	1350	1550	1750	1850	1850N	1950	1950N	2250	2450	2650	2650N	2850	3050	3350	3650
Windshield wipers and fan in cab roof															
S7-Electrical circuit diagram 30-14		x	x	x		x		x	x	x		x			
S7-Current circuit 30-15		x	x	x		x		x	x	x		x			
Signal horn and hazard warning lights system															
S8-Electrical circuit diagram 30-16		x	x	x		x		x	x	x		x			
S8-Current circuit 30-17		x	x	x		x		x	x	x		x			
Socket															
S9-Electrical circuit diagram 30-18		x	x	x		x		x	x	x		x			
S9-Current circuit 30-19		x	x	x		x		x	x	x		x			
Instrument cluster and front-wheel drive															
S10-Electrical circuit diagram 30-20		x	x	x		x		x	x	x		x			
S10-Current circuit 30-21		x	x	x		x		x	x	x		x			
Automatic four-wheel brake															
S10A-Electrical circuit diagram 30-22		x	x	x		x		x	x	x		x			
S10A-Current circuit 30-23		x	x	x		x		x	x	x		x			
Front PTO															
S11-Electrical circuit diagram 30-24		x	x	x		x		x	x	x		x			
S11-Current circuit 30-25		x	x	x		x		x	x	x		x			
Fan in dash panel															
S12-Electrical circuit diagram 30-26		x	x	x		x		x	x	x		x			
S12-Current circuit 30-27		x	x	x		x		x	x	x		x			
Worklights															
S13-Electrical circuit diagram 30-28		x	x	x		x		x	x	x		x			
S13-Current circuit 30-29		x	x	x		x		x	x	x		x			
Left-hand clearance light, right-hand tail light and 7-terminal socket															
S14-Electrical circuit diagram 30-30		x	x	x		x		x	x	x		x			
S14-Current circuit 30-31		x	x	x		x		x	x	x		x			
Parking lights, instrument lighting, right-hand clearance light, left-hand tail light and 7-terminal socket															
S15-Electrical circuit diagram 30-32		x	x	x		x		x	x	x		x			
S15-Current circuit 30-33		x	x	x		x		x	x	x		x			
High and low beam headlights															
S16-Electrical circuit diagram 30-34		x	x	x		x		x	x	x		x			
S16-Current circuit 30-35		x	x	x		x		x	x	x		x			
Hydrostatic creeper transmission															
S17-Electrical circuit diagram 30-36								x	x	x		x			
S17-Current circuit 30-37								x	x	x		x			

40 - CIRCUIT DIAGNOSIS (With SG2 Cab)

	1350	1550	1750	1850	1850N	1950	1950N	2250	2450	2650	2650N	2850	3050	3350	3650
Special tools								x	x	x		x	x	x	x
Starting motor and charging circuit															
S1-Electrical circuit diagram								x	x	x		x	x	x	x
S1-Current circuit								x	x	x		x	x	x	x
S1A-Electrical circuit diagram								x	x	x		x	x	x	x
S1A-Current circuit								x	x	x		x	x	x	x
Cold weather starting aids															
S2-Electrical circuit diagram								x	x	x		x	x	x	x
S2-Current circuit								x	x	x		x	x	x	x
Fuel preheater															
S3-Electrical circuit diagram								x	x	x		x	x	x	x
S3-Current circuit								x	x	x		x	x	x	x
Hazard warning and turn signal lights															
S4-Electrical circuit diagram								x	x	x		x	x	x	x
S4-Current circuit								x	x	x		x	x	x	x
Blower fan, air conditioning system, windshield washer system and radio															
S5-Electrical circuit diagram								x	x	x		x	x	x	x
S5-Current circuit								x	x	x		x	x	x	x
Blower fan, windshield wipers and radio															
S5A-Electrical circuit diagram								x	x	x		x	x	x	
S5A-Current circuit								x	x	x		x	x	x	
Stop lights															
S6-Electrical circuit diagram								x	x	x		x	x	x	x
S6-Current circuit								x	x	x		x	x	x	x
High and low beam headlights															
S7-Electrical circuit diagram								x	x	x		x	x	x	x
S7-Current circuit								x	x	x		x	x	x	x
Parking lights, instrument lighting and worklights															
S8-Electrical circuit diagram								x	x	x		x	x	x	x
S8-Current circuit								x	x	x		x	x	x	x
Left-hand clearance light, right-hand tail light and 7-terminal socket															
S9-Electrical circuit diagram								x	x	x		x	x	x	x
S9-Current circuit								x	x	x		x	x	x	x
Right-hand clearance light, left-hand tail light, shift console light and emergency lighting															
S10-Electrical circuit diagram								x	x	x		x	x	x	x
S10-Current circuit								x	x	x		x	x	x	x
Front PTO															
S11-Electrical circuit diagram								x	x	x		x		x	x
S11-Current circuit								x	x	x		x		x	x

40 - CIRCUIT DIAGNOSIS (With SG2 Cab) - Contd.

Control unit and front-wheel drive	
S12-Electrical circuit diagram	40-28
S12-Current circuit	40-29
Automatic engagement of front-wheel drive	
S12A-Electrical circuit diagram	40-30
S12A-Current circuit	40-31
Automatic four-wheel brake	
S12B-Electrical circuit diagram	40-32
S12B-Current circuit	40-33
Horn, outlet socket and speed meter	
S13-Electrical circuit diagram	40-34
S13-Current circuit	40-35
Windshield wiper system	
S14-Electrical circuit diagram	40-36
S14-Current circuit	40-37
Hi-Lo shift unit indicator light	
S14A-Electrical circuit diagram	40-38
S14A-Current circuit	40-39
Windshield wiper system	
S14B-Electrical circuit diagram	40-40
S14B-Current circuit	40-41
Hydrostatic creeper transmission	
S15-Electrical circuit diagram	40-42
S15-Current circuit	40-43

**41 - ELECTRICAL DIAGRAMS
(With Digital Speed-Hour Meter)**

Parts designation in electrical circuit and wiring diagrams	41-1
Section designations in circuit diagrams	41-4
Harness designations in wiring diagrams	41-4
Electrical circuit diagram (complete tractor)	41-5
Engine wiring harness	41-8
Wiring diagram - Engine	41-9
Dash panel wiring harnesses	41-10
Wiring diagram - Dash panel	41-11
Wiring harnesses - SG2-cab	41-12
Transmission wiring harness	41-13
Wiring diagram - SG2 cab and transmission ...	41-15
Printed circuit board -	
Dash panel, left-hand	41-16
Pin assignment - Dash panel, left-hand	41-17

	1350	1550	1750	1850	1850N	1950	1950N	2250	2450	2650	2650N	2850	3050	3350	3650
Control unit and front-wheel drive															
S12-Electrical circuit diagram								x	x	x		x	x	x	x
S12-Current circuit								x	x	x		x	x	x	x
Automatic engagement of front-wheel drive															
S12A-Electrical circuit diagram															x
S12A-Current circuit															x
Automatic four-wheel brake															
S12B-Electrical circuit diagram								x	x	x		x	x	x	x
S12B-Current circuit								x	x	x		x	x	x	x
Horn, outlet socket and speed meter															
S13-Electrical circuit diagram								x	x	x		x	x	x	x
S13-Current circuit								x	x	x		x	x	x	x
Windshield wiper system															
S14-Electrical circuit diagram								x	x	x		x	x	x	x
S14-Current circuit								x	x	x		x	x	x	x
Hi-Lo shift unit indicator light															
S14A-Electrical circuit diagram								x	x	x		x	x	x	x
S14A-Current circuit								x	x	x		x	x	x	x
Windshield wiper system															
S14B-Electrical circuit diagram								x	x	x		x	x	x	
S14B-Current circuit								x	x	x		x	x	x	
Hydrostatic creeper transmission															
S15-Electrical circuit diagram								x	x	x		x			
S15-Current circuit								x	x	x		x			
Parts designation in electrical circuit and wiring diagrams								x	x	x		x	x	x	x
Section designations in circuit diagrams								x	x	x		x	x	x	x
Harness designations in wiring diagrams								x	x	x		x	x	x	x
Electrical circuit diagram (complete tractor)								x	x	x		x	x	x	x
Engine wiring harness								x	x	x		x	x	x	x
Wiring diagram - Engine								x	x	x		x	x	x	x
Dash panel wiring harnesses								x	x	x		x	x	x	x
Wiring diagram - Dash panel								x	x	x		x	x	x	x
Wiring harnesses - SG2-cab								x	x	x		x	x	x	x
Transmission wiring harness								x	x	x		x	x	x	x
Wiring diagram - SG2 cab and transmission ...								x	x	x		x	x	x	x
Printed circuit board -															
Dash panel, left-hand								x	x	x		x	x	x	x
Pin assignment - Dash panel, left-hand								x	x	x		x	x	x	x

42 – CIRCUIT DIAGNOSIS (With Digital Speed-Hour Meter)

	1350	1550	1750	1850	1850N	1950	1950N	2250	2450	2650	2650N	2850	3050	3350	3650
Special tools								x	x	x		x	x	x	x
Starting motor, charging circuit and hand-brake indicator light															
S1-Electrical circuit diagram								x	x	x		x	x	x	x
S1-Current circuit								x	x	x		x	x	x	x
Electrical cold weather starting aid															
S2-Electrical circuit diagram								x	x	x		x	x	x	x
S2-Current circuit								x	x	x		x	x	x	x
Fuel preheater															
S3-Electrical circuit diagram								x	x	x		x	x	x	x
S3-Current circuit								x	x	x		x	x	x	x
Blower fan, air conditioning system, windshield washer system and cab interior lighting															
S4-Electrical circuit diagram								x	x	x		x	x	x	x
S4-Current circuit								x	x	x		x	x	x	x
Hazard warning and turn signal lights															
S5-Electrical circuit diagram								x	x	x		x	x	x	x
S5-Current circuit								x	x	x		x	x	x	x
Parking lights, instrument lighting and worklights															
S6-Electrical circuit diagram								x	x	x		x	x	x	
S6-Current circuit								x	x	x		x	x	x	
High and low beam headlights															
S7-Electrical circuit diagram								x	x	x		x	x	x	x
S7-Current circuit								x	x	x		x	x	x	x
Left-hand clearance light, right-hand tail light and 7-terminal socket															
S8-Electrical circuit diagram								x	x	x		x	x	x	x
S8-Current circuit								x	x	x		x	x	x	x
Right-hand clearance light, left-hand tail light, and shift console light															
S9-Electrical circuit diagram								x	x	x		x	x	x	x
S9-Current circuit								x	x	x		x	x	x	x
Stop lights															
S10-Electrical circuit diagram								x	x	x		x	x	x	x
S10-Current circuit								x	x	x		x	x	x	x
Automatic four wheel brake															
S11-Electrical circuit diagram								x	x	x		x	x	x	x
S11-Current circuit								x	x	x		x	x	x	x

ELEKTR-LB524008AE-010490

	1350	1550	1750	1850	1850N	1950	1950N	2250	2450	2650	2650N	2850	3050	3350	3650
Horn and hazard warning light switch															
S12-Electrical circuit diagram 42-24								x	x	x		x	x	x	x
S12-Current circuit 42-25								x	x	x		x	x	x	x
Front PTO															
S13-Electrical circuit diagram 42-26								x	x	x		x	x	x	x
S13-Current circuit 42-27								x	x	x		x	x	x	x
Windshield wiper system															
S14-Electrical circuit diagram 42-28								x	x	x		x	x	x	x
S14-Current circuit 42-29								x	x	x		x	x	x	x
Control unit, front wheel drive and digital speed-hour meter															
S15-Electrical circuit diagram 42-30								x	x	x		x	x	x	x
S15-Current circuit 42-30								x	x	x		x	x	x	x
45 - TESTING COMPONENTS															
Special tools 45-1	x	x	x	x	x	x	x	x	x	x	x	x	x	x	x
Connecting battery tester FKM10409 45-2	x	x	x	x	x	x	x	x	x	x	x	x	x	x	x
Testing battery 45-2	x	x	x	x	x	x	x	x	x	x	x	x	x	x	x
Testing automatic engagement of front wheel drive 45-3															x
Testing starter switch 45-4	x	x	x	x	x	x	x	x	x	x	x	x	x	x	x
Testing main switch 45-4	x	x	x	x	x	x	x	x	x	x	x	x	x	x	x
Testing turn signal relay 45-4	x	x	x	x	x	x	x	x	x	x	x	x	x	x	x
Testing hazard warning light switch 45-4	x	x	x	x	x	x	x	x	x	x	x	x	x	x	x
Testing windshield wiper switch 45-5								x	x	x		x	x	x	x
Testing blower fan switch resistor 45-5		x	x	x		x		x	x	x		x	x	x	x
Testing compressor clutch 45-5								x	x	x		x	x	x	x
Testing hour meter 45-6	x	x	x	x	x	x	x	x	x	x	x	x	x	x	x
Testing magnetic sending unit of engine speed meter 45-6	x	x	x	x	x	x	x	x	x	x	x	x	x	x	x
Testing engine speed meter 45-6	x	x	x	x	x	x	x	x	x	x	x	x	x	x	x

45 – TESTING COMPONENTS – CONTD.

Testing windshield wiper motor	45-7
Testing air filter restriction indicator light	45-7
Testing turn signal switch	45-7
Testing a working relay	45-8
Testing start safety switch	45-8
Testing stop light switch	45-8
Testing fuel gauge	45-9
Testing fuel gauge sending unit using an ohmmeter	45-9
Testing fuel gauge using a variable resistor	45-9
Testing coolant temperature gauge and sending unit	45-9
Testing engine oil pressure warning switch	45-10
Testing front wheel drive solenoid	45-10
Testing front PTO solenoid	45-10
Testing a tumbler switch	45-10

50 – STARTING MOTOR

Specifications	50-1
Function of starting motor	50-3

55 – ALTERNATOR

Special tools	55-1
Specifications	55-1
Function of alternator	55-2
Testing alternator voltage	55-3
Testing alternator output current	55-3

	1350	1550	1750	1850	1850N	1950	1950N	2250	2450	2650	2650N	2850	3050	3350	3650
Testing windshield wiper motor								X	X	X		X	X	X	X
Testing air filter restriction indicator light	X	X	X	X	X	X	X	X	X	X	X	X	X	X	X
Testing turn signal switch	X	X	X	X	X	X	X	X	X	X	X	X	X	X	X
Testing a working relay	X	X	X	X	X	X	X	X	X	X	X	X	X	X	X
Testing start safety switch	X	X	X	X	X	X	X	X	X	X	X	X	X	X	X
Testing stop light switch	X	X	X	X	X	X	X	X	X	X	X	X	X	X	X
Testing fuel gauge	X	X	X	X	X	X	X	X	X	X	X	X	X	X	X
Testing fuel gauge sending unit using an ohmmeter	X	X	X	X	X	X	X	X	X	X	X	X	X	X	X
Testing fuel gauge using a variable resistor	X	X	X	X	X	X	X	X	X	X	X	X	X	X	X
Testing coolant temperature gauge and sending unit	X	X	X	X	X	X	X	X	X	X	X	X	X	X	X
Testing engine oil pressure warning switch	X	X	X	X	X	X	X	X	X	X	X	X	X	X	X
Testing front wheel drive solenoid	X	X	X	X	X	X	X	X	X	X	X	X	X	X	X
Testing front PTO solenoid								X	X	X		X		X	X
Testing a tumbler switch	X	X	X	X	X	X	X	X	X	X	X	X	X	X	X
Specifications	X	X	X	X	X	X	X	X	X	X	X	X	X	X	X
Function of starting motor	X	X	X	X	X	X	X	X	X	X	X	X	X	X	X
Special tools	X	X	X	X	X	X	X	X	X	X	X	X	X	X	X
Specifications	X	X	X	X	X	X	X	X	X	X	X	X	X	X	X
Function of alternator	X	X	X	X	X	X	X	X	X	X	X	X	X	X	X
Testing alternator voltage	X	X	X	X	X	X	X	X	X	X	X	X	X	X	X
Testing alternator output current	X	X	X	X	X	X	X	X	X	X	X	X	X	X	X

DESCRIPTION

The tractor is equipped with a 12-volt electrical system.

On tractors 1350 to 2850 without cab the two parallel connected 12-volt batteries are located in front of the dash panel and are accessible through two side covers which fold upwards.

On tractors 3050 to 3650 without cab the batteries are located underneath the left and right-hand step.

On tractors with cab the batteries are located below the cab doors.

The negative pole of each battery is grounded with a ground strap.

The two batteries are connected in parallel, whereby the positive pole of each battery is connected to the starting motor.

The charging circuit is equipped with a 14-volt alternator and attached regulator and the starting circuit with a 12-volt starting motor and solenoid.

The tractor may be equipped with a 55 Ah or 85 Ah alternator.

On tractors without cab or with MC1 cab all instruments are located in the instrument cluster in the centre of the dash panel.

On tractors with SG2 cab the majority of the control instruments are located on the left-hand side of the dash panel.

ALLG-LB524005AE-010288



Suggest:

If the above button click is invalid.

Please download this document

first, and then click the above link

to download the complete manual.

Thank you so much for reading

IMPORTANT NOTES

With the engine running, do not short or ground (even momentarily) alternator terminals.

If the tractor is to be started with a slave battery and operated for a short time without battery, do not under any circumstances, interrupt the circuit by switching off the main switch before stopping the engine via the fuel pump shut-off cable. While engine is running, an additional consumer (lights) should be switched on. Do not run engine at speeds above 1000 rpm. Insulate the battery end of disconnected starter cables properly to avoid damage to alternator and regulator.

Do not connect negative pole of slave battery to operator's cab.

Ensure correct polarity when connecting batteries and battery chargers. If they are improperly connected, the rectifier diodes will be immediately destroyed.

Before carrying out electric welding repairs on the tractor, disconnect cables from battery terminals and from terminals B+ and D+ of alternator. Also disconnect the 21-pin plug mounted on dash panel above fuel filter. Connect ground terminal of welding apparatus directly to the part being welded.

Before carrying out work on the electrical system of the tractor, the battery ground straps must be disconnected in order to avoid the danger of short circuits.

SCHALTPL-LB524005AE-010389

<https://www.ebooklibonline.com>

Hello dear friend!

Thank you very much for reading.

Enter the link into your browser.

The full manual is available for immediate download.

<https://www.ebooklibonline.com>